

# OWNERS and SERVICE MANUAL for



MODEL 345

This binder contains the complete owners and technical manuals for the Memorymoog. As updates and improvements are made in the instrument, they will be described in the Addenda section in the back of the manual.



# MEMORYMOOG OWNERS MANUAL

## CONTENTS

INTRODUCTION .....	1
SECTION I	
Setting Up .....	2
Calling Up Programs .....	3
Editing A Sound .....	3
Calling Up and Stepping Through Program Sequences .....	4
SECTION II	
Keyboard/Performance Controls .....	5
Left-Hand Controllers .....	7
System Controller .....	7
Footpedals .....	10
LFO Modulation .....	10
Oscillators .....	12
Mixer .....	13
Voltage Controlled Filter .....	13
Voltage Controlled Amplifier .....	14
Contour Controls .....	14
Outputs .....	15
The Back Panel .....	15
Hi-Level Audio Output .....	15
Footpedal In .....	15
External Synthesizer Out .....	16
Footswitch In .....	16
Cassette Interface .....	16
Power On/Off .....	16
Powercord .....	16
SECTION III	
The System Controller .....	17
Calling Up Programs .....	17
Recording Programs .....	18
Program Sequences .....	20
Loading Your Own Program Sequence .....	20
The Cassette Interface .....	22
Interfacing the Memorymoog to a Monophonic Synth .....	22
The Keyboard .....	23
Changing the Number of Voices the Keyboard Controls in Mono Mode .....	25
Single/Multiple Trigger .....	25
The Hold Function .....	26
The Arpeggiator .....	26
The Oscillators .....	27
Waveshape .....	27
Sync 2 to 1 .....	28

## CONTENTS (Continued)

Frequency Controls .....	29
Osc 3 as a Low-Frequency Oscillator .....	30
The Noise Source .....	30
The Mixer .....	30
The Voltage-Controlled Filter .....	31
Emphasis .....	31
KB Track .....	32
Contour Amount .....	33
The Contour Generators .....	33
Contour Mode Controls .....	35
Unconditional Contours .....	36
Keyboard Follow .....	37
Outputs .....	38
Modulation .....	39
LFO Modulation .....	39
Voice Modulation .....	43
The Programmable Footpedals .....	48
MEMORYMOOG SOUND CHARTS .....	49

## INTRODUCTION

The Memorymoog is a voice-assignment polyphonic synthesizer with the ability to store up to 100 patches in computer memory. It has six independent voices, each containing three voltage-controlled oscillators, a voltage-controlled 24dB/octave lowpass filter, two ADSR contour generators, and extensive modulation facilities. This means that there are 18 oscillators, six filters, and 12 contour generators in the unit. However, there is a single set of controls for those components, meaning that their sound is programmed homophonically — each program governs each voice identically.

At the heart of the Memorymoog is the System Controller which gives you command over the instrument's microprocessor. With the System Controller you can change programs, store patches, change keyboard modes, use the cassette interface, alter arpeggiation mode, and set up program sequences. Learning to use the System Controller is the key to learning how to use the Memorymoog.

This manual is designed in sections, starting with a quick setup guide for those of you who are in a hurry to quit reading and start playing. It tells you some dos and don'ts about setting up and explains what you'll need to know about the System Controller in order to get at the programs. Section II is a reference guide designed to help answer any questions regarding specific features on the Memorymoog. Section III is a step-by-step explanation of each set of controls for those of you who aren't all that familiar with synthesis. It's designed to help clarify things that may seem vague in Section II. The final section of the manual deals with service information and contains schematics and maintenance details. A sound chart section is included that contains diagrams of all the factory programs. Some blank panel diagrams are also provided for you to copy down your own patches.

# SECTION I

## SETTING UP

If you haven't bought a flight case for your Memorymoog, save the carton it came in in case you have to arrange long distance transportation.

After unpacking your instrument, hook it up to a wall socket by first inserting the detachable three-pronged cord into the back of the Memorymoog and then into the power outlet. Be sure that the outlet is putting out the right amount of voltage.

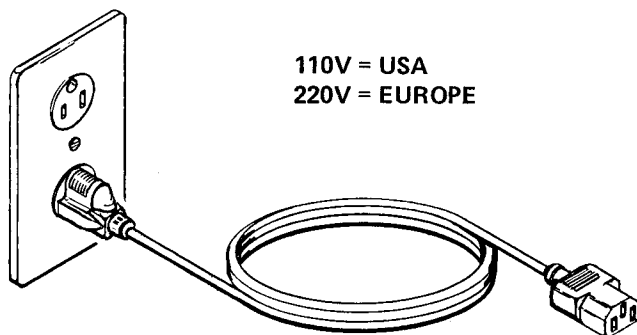

If you want to operate your Memorymoog on a voltage that differs from what's coming out of the wall socket, i.e. 220 instead of 110 or 110 instead of 220, an authorized Moog service center can set up your instrument to operate at the proper voltage.

Next hook any footpedals or switches you desire to use up to their respective inputs. Then connect the audio output of the Memorymoog to an amplification system using either an XLR cable or a 1/4" phone jack. A high quality amp is desirable due to the wide frequency range of the Memorymoog. Also, note that different amps will make the programs sound different.

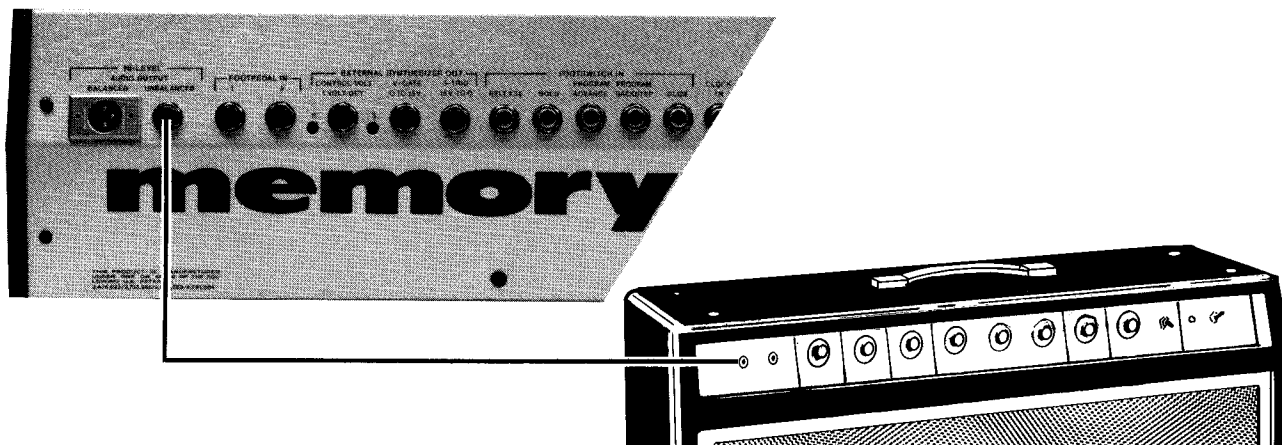

Turn the output volume of both the Memorymoog and the amp down to zero. Turn the Memorymoog on and then turn the amp on. Bring the volume of the amp up to where you're used to setting it. While holding down a note, bring the MASTER VOLUME control (at the upper right corner) up until it's at a comfortable level.

After you've turned the instrument on, let it warm up for about 10 minutes to allow the oscillators to stabilize. Then hit the AUTO TUNE control in the upper left-hand corner. This will tune the Memorymoog's 18 oscillators. Notice that the SYSTEM CONTROLLER's Alphanumeric Display reads "6 TUNED" after the tuning cycle is complete, indicating that all six voices have been tuned. If a number less than six appears in the screen, it means that the system was unable to tune one or more of the oscillators for some reason. Try hitting the AUTO TUNE switch again if this occurs. If they still fail to tune, they can be manually disabled. Refer to the Service Section of the manual for details.

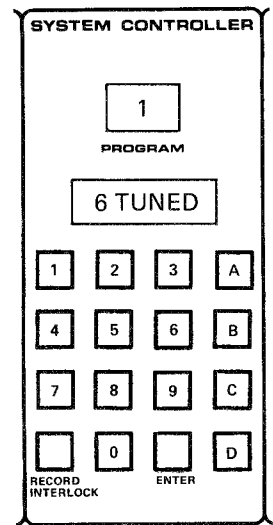

### CALLING UP PROGRAMS

When you first turn the Memorymoog on, program Number 1 will appear in the PROGRAM DISPLAY window of the SYSTEM CONTROLLER. To change program numbers, hit any number from 0 to 99 followed by hitting the ENTER button on the Numeric Keyboard of the SYSTEM CONTROLLER.

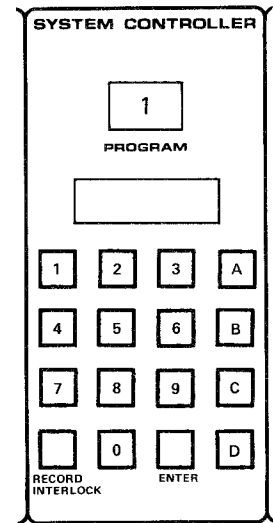

EDIT }  
030 052 }

### EDITING A SOUND

Changing or editing programs is very simple. If you want to alter some aspect of any of the sounds supplied by the factory, all you have to do is hit any of the switches (except those in the SYSTEM CONTROLLER) or hit any of the rotary controls (pots). You'll notice that when you hit a switch the Alphanumeric Display will read "EDIT," and when you turn a pot, six numbers appear in the display screen. The group of three numbers on the left indicates the value of the pot as it is in the program memory, and the group of three numbers on the right indicates the current value of the pot.

Hitting the ENTER button will immediately restore the program values.

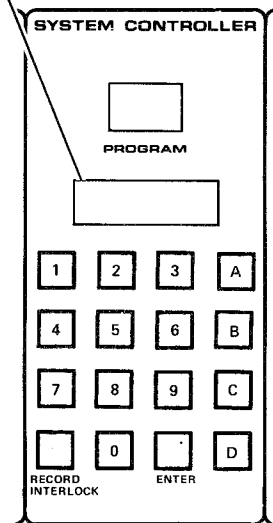

## CALLING UP AND STEPPING THROUGH PROGRAM SEQUENCES

To get into the PROGRAM SEQUENCE MODE hit PREFIX letter D, followed by any number from 0 to 9, followed by ENTER. This gets you to one of the 10 PROGRAM SEQUENCES. What will appear in the Alphanumeric Display looks like this:

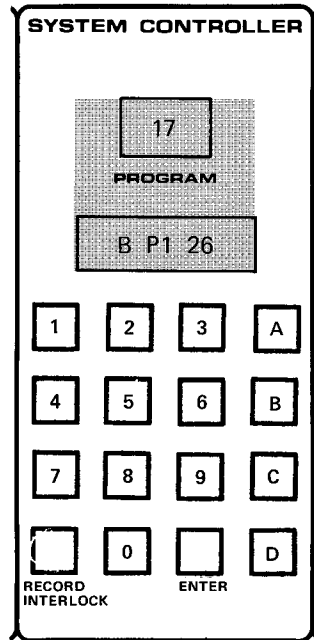

The number in the PROGRAM DISPLAY is the first program of the PROGRAM SEQUENCE. The B at the left of the screen indicates the beginning of the SEQUENCE. As you step through the SEQUENCE, the number that appears in this spot indicates the previous program number. The center of the display shows the PROGRAM SEQUENCE number, and the number to the right of the screen is the program number next in line in the SEQUENCE.

To step through the PROGRAM SEQUENCE, use the A PREFIX switch to go forward and the B PREFIX switch to go backward. You can also use PROGRAM ADVANCE and PROGRAM BACKSTEP footswitches for these functions. (Note that the footswitches aren't supplied with the instrument.)

Experimenting with the programs, editing them, and stepping through the PROGRAM SEQUENCES should keep you busy for at least a few minutes. It should also start generating questions about other features on the instrument. Section II of the manual provides brief descriptions of all the various functions of the Memorymoog, while Section III offers step-by-step explanations. From this point, refer to those sections as the need arises.



## SECTION II

This section of the Memorymoog manual is designed to answer questions about the function of each control on the front and back panels of the instrument. It's a quick reference guide; more detailed explanations will be found in the next portion of the manual.

### 1.0 KEYBOARD/PERFORMANCE CONTROLS.

#### 1.1 AUTO TUNE.

Touching this switch causes the computer in the unit to tune the 18 oscillators. Tuning takes about 8 seconds. The instrument will be "dead" for that period of time. The SYSTEM CONTROLLER's (3.0) Alphanumeric Display will show "TUNING" when the switch is initially depressed, and it will show how many voices have been tuned at the end of the tuning cycle.

#### 1.2 TUNE.

Lets you fine tune the instrument over a range of  $\pm 3$  semitones. This is a non-programmable control and will affect all voices identically.

#### 1.3 MONO.

This switch puts the instrument into the monophonic mode — it will play only one key at a time. The number of voice cards you control is variable from 1 up to 6, giving you control over from 1 to 18 oscillators. This is programmed by the SYSTEM CONTROLLER (3.0) and the MIXER section (7.0).

#### 1.4 MULTIPLE TRIGGER.

When on, the keyboard triggers all contours when any new keys are depressed. When off, new notes trigger only the assigned voice.

#### 1.5 KB OUT.

KEYBOARD OUT controls the trigger and voltage outputs from the EXTERNAL SYNTHESIZER OUTPUT section (14.0). It's used when controlling an external synthesizer. When on, the Memorymoog will control the external synthesizer.

#### 1.6 GLIDE AMOUNT AND GLIDE ON/OFF.

The glide is both monophonic and polyphonic. When the instrument is in mono mode, a master glide circuit takes over for the 6 separate glide circuits that work when it's in polyphonic mode, and allows the instrument to glide in unison. Glide is linear. Maximum glide time between the outer notes of the keyboard is about 10 seconds.

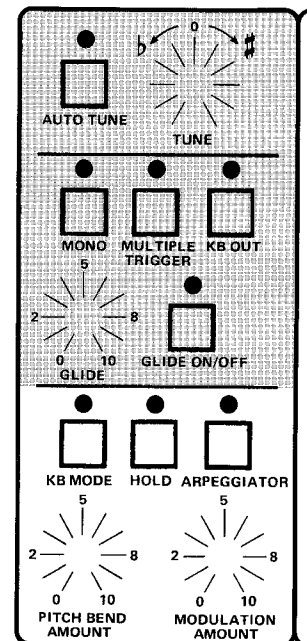

### 1.7 KB MODE.

KEYBOARD MODE affects the priority of the keyboard when it's in both mono and polyphonic modes. In mono mode, the SYSTEM CONTROLLER (3.0) Alphanumeric Display shows either "MONO 1, 2 or 3," depending on the mono mode programmed. Mono 1 is last-note priority, Mono 2 is low-note priority, and Mono 3 is high-note priority. In polyphonic mode, the Alphanumeric Display will show either "POLY 1" (cyclic), "2" (cyclic with memory), "3" (reset to voice A), or "4" (reset to voice A with memory). Voltages routed to an external synth via the EXTERNAL SYNTHESIZER OUTPUT (14.0) are affected by this control.

### 1.8 HOLD.

Lets you build up chords and transpose them in parallel motion from the keyboard. Holding a chord and then pressing the HOLD button will memorize the chord. Holding down the HOLD button and then pressing notes on the keyboard will let you build widely spaced chords. Releasing the HOLD button memorizes the chord. The chord can then be transposed from the last note you played on the keyboard.

### 1.9 ARPEGGIATOR.

Continuously triggers note played on the keyboard. Rate is set by the LFO (5.0) speed. The Clock can be overridden by an external trigger source at the CLOCK IN (15.5) on the back panel. The internal clock is reset by the keyboard so you can always play in time. The Arpeggiator operates in six different modes:

- 1) Plays back notes from bottom to top, unlatched (notes stop when you lift off the keyboard).
- 2) Plays back notes from top to bottom, unlatched.
- 3) Plays back notes from top to bottom, and then from bottom to top, unlatched.
- 4) Plays back notes from bottom to top (latched). The notes will continue if you lift your hands off the keyboard.
- 5) Plays back notes from top to bottom, latched.
- 6) Plays back notes from top to bottom, and then from bottom to top, latched.

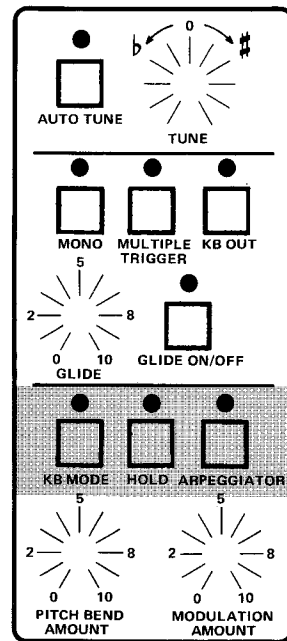

### 1.10 PITCH BEND AMOUNT.

Lets you vary the maximum range of the PITCH BENDING WHEEL (2.2) up to  $\pm 1$  octave. Note that this control is programmable.

### 1.11 MODULATION AMOUNT.

Sets a programmable initial modulation amount. The MODULATION WHEEL (2.3) adds to the amount set by this control.

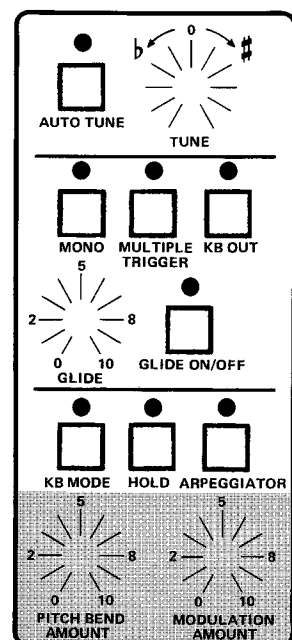

## 2.0 LEFT-HAND CONTROLLERS.

### 2.1 OCTAVE SWITCHES.

These are not programmable. They raise or lower the pitch of all oscillators by one octave.

### 2.2 PITCH WHEEL.

Lets you bend the pitch of what's played on the keyboard by an amount determined by the PITCH BEND AMOUNT control (1.11).

### 2.3 MODULATION WHEEL.

For injecting modulation from the LFO (5.0). Adds to the initial amount of modulation programmed by the MODULATION AMOUNT control (1.12).

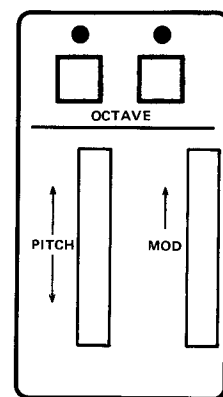

## 3.0 SYSTEM CONTROLLER.

### 3.1 PROGRAM DISPLAY.

The large numeric LED (Light Emitting Diode) display shows which program number has been called up. Program numbers range from 0 to 99.

### 3.2 ALPHANUMERIC DISPLAY.

Through this display, the Memorymoog's computer conveys various sorts of information about what is going on in the instrument. When the AUTO TUNE cycle is complete, it will display how many voice cards have been tuned up by showing "1, 2, 3, 4, 5 or 6 TUNED." Note that any number less than 6 indicates that the computer couldn't tune one of the voice cards for some reason.

If you change any part of the current program in the display by activating a control pot or switch, it will read "EDIT." If you've changed a rotary pot's position, the left side of the display will show the value of that pot as it is in memory, while the right side displays the current value. With this readout, you can match old programs or return a pot to its original value.

Keyboard mode is indicated on the Alphanumeric Display when you hit the KB MODE switch (1.7). When the RECORD INTERLOCK button (3.4) is hit, the display will read "LOCK." When a program has been recorded into memory the display will read "RECORDED."

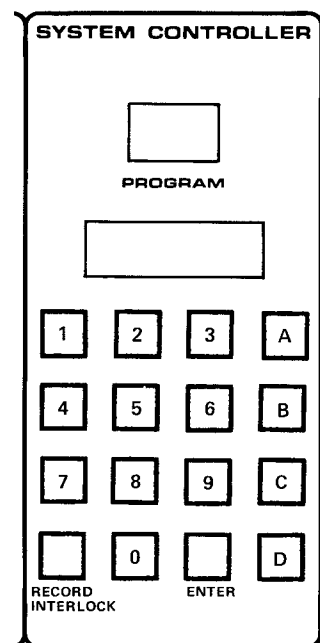

### 3.3 NUMERIC KEYBOARD.

This calculator-type keyboard is used for calling up programs and other control functions. You do this by hitting one or two numbers (from 0 to 99) and then pressing the ENTER button.

### 3.4 RECORD INTERLOCK.

This switch is used to temporarily lock the front panel settings in memory. By hitting LOCK, the Alphanumeric Display (3.2) will read "LOCK," indicating that the current panel settings are temporarily locked, and turning pots or hitting switches will have no effect. This allows you to call up another patch from memory (by hitting a number and pressing ENTER) without losing the locked patch. Hitting the LOCK switch after you've called up another patch will bring up the locked patch. This is useful for checking edited patches against the original version.

### 3.5 STORING A PATCH IN MEMORY.

This is done by holding the LOCK button (3.4) down and hitting the ENTER button (see 3.3). This loads whatever is currently shown on the front panel into the memory position called up in the Program Display (3.1). Note that recording a patch is impossible if the Memorymoog is "write disabled," meaning that a protect function against storing unwanted information in memory is on. To turn the protect function off and on, you must know the four-digit security code (see Section III). Attempting to store a patch in memory when the disable feature is on will cause the Alphanumeric Display (3.2) to read "DISABLED." When a patch has been successfully written into a memory position the Alphanumeric Display will read "RECORDED."

### 3.6 PREFIX BUTTONS.

**PREFIX A** advances programs stored in the PROGRAM SEQUENCE MODE (see below). Also advances program number by one in normal operating mode.

**PREFIX B** steps in reverse through the programs in the PROGRAM SEQUENCE MODE (see below). Backsteps program number by one in normal operating mode.

**PREFIX C1** (*hit C, hit 1, hit ENTER*) saves programs onto cassette tape (for more information on this procedure see the next section of the manual).

**PREFIX C2** (*hit C, hit 2, hit ENTER*) loads programs from cassette tape into the Memorymoog's memory.

**PREFIX C3** (*hit C, hit 3, hit ENTER*) verifies correct loading of programs when putting programs from the Memorymoog onto cassette tape.

**PREFIX C4** is used for defeating voices that aren't tuning up for whatever reason. See text in next section of the manual for details.

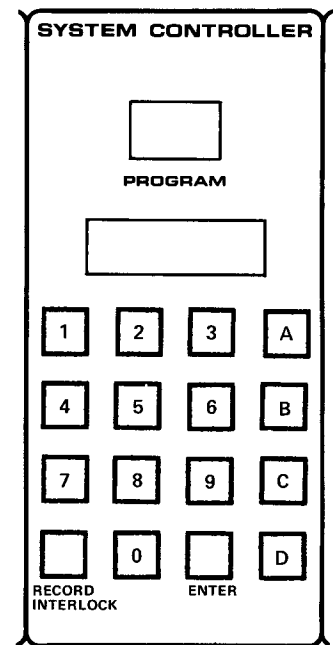

**PREFIX C5** tunes all oscillators to unison, regardless of front panel settings.

**PREFIXES C6 and C7** are electronic tuning aids for service technicians.

**PREFIX C8** displays current memory status, ENABLED or DISABLED in the Alphanumeric Display (3.2). The unit powers up with the memory disabled so that you can't accidentally record a patch and you can't use the cassette interface functions of PREFIXES C1, 2, and 3. To enable the memory store function, hit C8 followed by the four-digit security code (see Section III). Hitting the letter C after entering C8 tells the instrument that you want to change the security code. Do this by entering the old four-digit code (the code of instruments fresh from the factory is 0000); the display will read "NEW CODE" or "BAD CODE" depending on if you have it right or not. If the old code is correct, you may then enter any new four-digit code.

**PREFIX C9** makes the front panel live. The Alphanumeric Display (3.2) will read "LIVE PNL" when you hit C, hit 9, hit ENTER. In this state, the front panel controls override the memory settings.

**PREFIX C0** flashes all the LEDs. This is another service function to check if all the LEDs work. Hitting any switch turns the function off.

**PREFIXES D0 to D9** call up PROGRAM SEQUENCES. These are chains of up to 20 programs, each arranged in some predetermined order. To call one up hit D, hit a number from 0 to 9, and hit ENTER. To load a PROGRAM SEQUENCE, hit D, hit D again, hit a number from 0 to 9 and hit ENTER to get into PROGRAM SEQUENCE LOADING MODE. Then to enter programs, hit the program number, hit ENTER, hit A (ADVANCE switch) or B (BACKSTEP switch). Repeat until you've loaded all the programs you require. The loading mode will stop after 10 programs are loaded. You can also use the ADVANCE and BACKSTEP footswitches (15.3 and 15.4) to step forward and backward in the PROGRAM SEQUENCE.

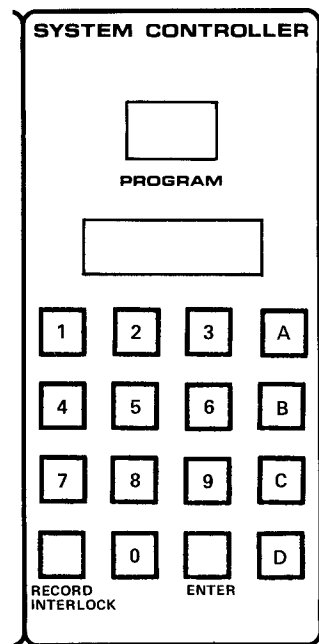

## 4.0 FOOTPEDALS.

### 4.1 AMOUNT 1, PITCH, VOLUME, FILTER.

The AMOUNT knob controls the overall range of footpedal number 1 which can be routed to control the pitch of all the oscillators, the volume, and the filter's cutoff frequency. Functions are programmable.

### 4.2 AMOUNT 2, MOD AMT, OSC 2.

Determines the range of a second voltage pedal which can be routed to control the amount of modulation and/or the frequency of the second oscillator.

**NOTE:** Footpedals are not supplied with the instrument. The inputs on the back panel (13.0) will use any voltage input that ranges from 0 to 5 volts. If you plug in just one pedal, the input will crosscouple so that one footpedal will control whatever is called up on either PEDAL 1 or PEDAL 2's programs.

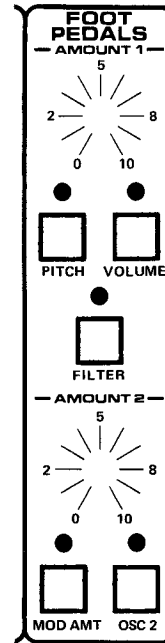

## 5.0 LFO MODULATION.

The amount of modulation is controlled by the MODULATION AMOUNT knob (1.12) and the MODULATION WHEEL (2.3).

### 5.1 RATE (HZ).

Controls the LFO frequency. Variable from .1Hz to 100Hz.

### 5.2 WAVESHAPES SELECTION.

Five switches to the right of the RATE (5.1) knob for selecting triangle, positive-going sawtooth, negative-going sawtooth, square, or sample-and-hold waveshapes for the low frequency oscillator. Selecting one waveshape excludes the others; waveshapes can't be intermixed.

### 5.3 DESTINATION SWITCHES.

The output of the LFO can be routed to seven places. It can be used to modulate the frequencies of oscillator 1 (OSC 1), oscillator 2 (OSC 2), oscillator 3 (OSC 3), the pulse width of oscillator 1 (PW 1), the pulse width of oscillator 2 (PW 2), the pulse width of oscillator 3 (PW 3), and/or the filter's cutoff frequency.

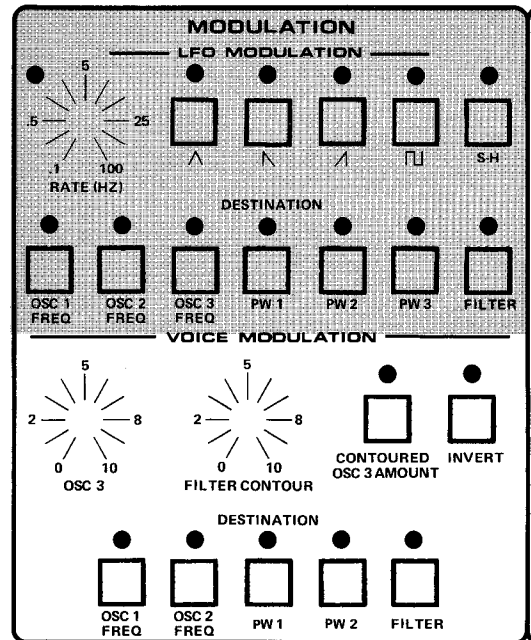

#### 5.4 VOICE MODULATION.

The source of this modulation is selectable from either the filter's contour generator or the third oscillator. These affect each voice independently. Voice Modulation is independent of the LFO Modulation (5.0).

#### 5.5 OSC 3.

Controls the amount of modulation from oscillator 3.

#### 5.6 FILTER CONTOUR.

Controls the amount of modulation from the filter's contour generator.

#### 5.7 CONTOURED OSC 3 AMOUNT.

When switched on allows the filter's contour generator to shape the amount of modulation coming from oscillator three. This is useful for creating modulation effects that vary with time.

#### 5.8 INVERT.

Inverts the filter contour as it's applied to the CONTOURED OSC 3 AMOUNT (5.7) and inverts the output of OSC 3 (6.0).

#### 5.9 DESTINATION SWITCHES.

Voice Modulation can be routed to five places using this set of switches: the frequency of oscillator 1 (OSC 1 FREQ), the frequency of oscillator 2 (OSC 2 FREQ), the pulse width of oscillator 1 (PW 1), the pulse width of oscillator 2 (PW 2), and/or the filter's cutoff frequency (FILTER).

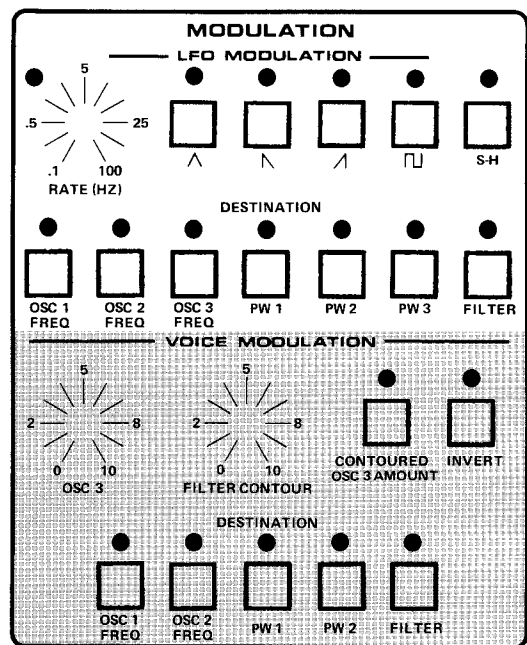

## 6.0 OSCILLATORS.

### 6.1 OCTAVE (oscillators 1, 2, 3).

16', 8', 4', and 2' octave settings for each oscillator are available via these switches. Note that the octave switches in the LEFT-HAND CONTROLLER section (2.0) will raise or lower the pitch of the oscillators one octave.

### 6.2 SYNC 2 TO 1 (oscillator 1 only).

Locks the fundamental frequency of oscillator 2 to that of oscillator 1. It is hard sync.

### 6.3 PULSE WIDTH (oscillators 1, 2, 3).

Varies the width of the rectangular waveshape from 0 to 100%. At the outer extremes of this range the pulse width will be so narrow that you won't hear any signal.

### 6.4 WAVESHAPES (oscillators 1, 2, 3).

These three switches let you call up pulse, sawtooth, and/or triangle waveshapes. Waveshapes can be combined.

### 6.5 FREQUENCY (oscillator 2).

A dual concentric pot which lets you tune the second oscillator  $\pm$  a minor sixth. The outer ring is for coarse control and the inner ring is for making finer adjustments.

### 6.6 FREQUENCY (oscillator 3).

Tunes the third oscillator  $\pm$  a minor sixth. However, when the KEYBOARD CONTROL switch (6.8) is off or the LOW switch (6.7) is on, the range of this knob is increased to 2-1/2 octaves.

### 6.7 LOW (oscillator 3 only).

Drops the frequency of oscillator 3 by approximately 5 octaves, converting it to a low frequency oscillator. With this switch on, the range of the FREQUENCY control (6.6) is increased to 2-1/2 octaves.

### 6.8 KEYBOARD CONTROL (oscillator 3 only).

For turning on and off the keyboard control voltage routed to oscillator 3. With the keyboard control voltage off, the range of the FREQUENCY control (6.6) is increased to 2-1/2 octaves.

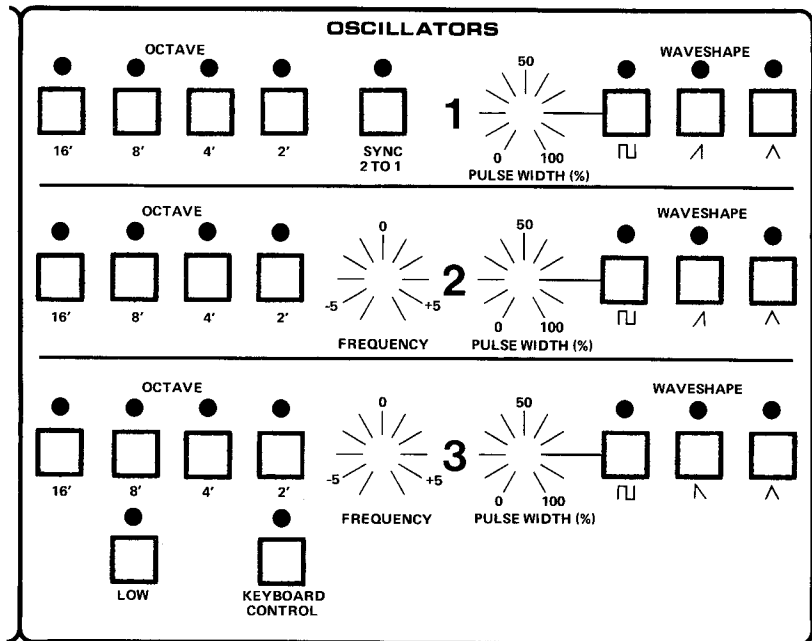



## 7.0 MIXER

Four level controls for adjusting the relative volumes of the three oscillators and a pink noise source as they feed into the filter. Note that beyond a setting of 4 or 5, these controls cause the signals to clip (distort). This gives a little more punch to a sound where desired. It also turns the triangle waves into sine waves. At a setting of 10 you will hear some intermodulation distortion.

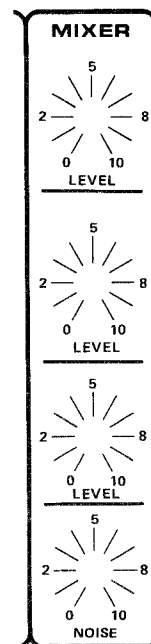

## 8.0 VOLTAGE CONTROLLED FILTER.

The Voltage Controlled Filter is the patented Moog 24db/octave lowpass filter.

### 8.1 KB TRACK.

Varies the amount of voltage from the keyboard that controls the filter cutoff frequency. You can select either 1/3 of the keyboard voltage, 2/3 of the keyboard voltage, all of the keyboard voltage (both switches on), or no keyboard voltage (both switches off).

### 8.2 CUTOFF.

Controls the cutoff frequency of the filter.

### 8.3 EMPHASIS.

Controls the degree of filter resonance. Oscillation begins at a little past a setting of 7.

### 8.4 CONTOUR AMOUNT.

Controls the amount of voltage from the FILTER CONTOUR GENERATOR (8.5) that is applied to the cutoff frequency.

### 8.5 FILTER CONTOUR GENERATOR.

#### 8.6 ATTACK.

Varies the attack time from 1 millisecond to 10 seconds.

#### 8.7 DECAY.

Variable from 2 milliseconds to 20 seconds.

#### 8.8 SUSTAIN.

Varies the sustain level of the filter contour.

#### 8.9 RELEASE.

Adjustable from 2 milliseconds to 20 seconds. The RELEASE SWITCH (10.4) and/or the RELEASE FOOTSWITCH (15.1) turn the release portion of the contour on and off.

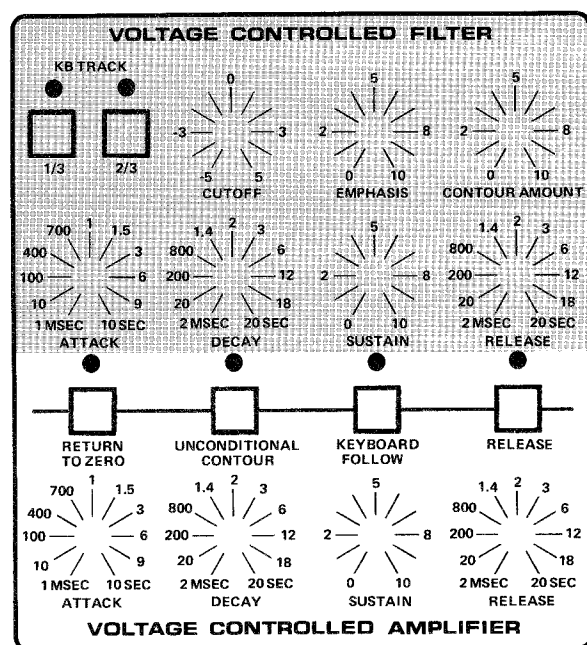

## 9.0 VOLTAGE CONTROLLED AMPLIFIER.

An ADSR contour generator controls the VCA.

### 9.1 ATTACK.

Same as section 8.6.

### 9.2 DECAY.

Same as section 8.7.

### 9.3 SUSTAIN.

Same as section 8.8.

### 9.4 RELEASE.

Same as section 8.9.

## 10.0 CONTOUR CONTROLS.

This set of four switches affects both Contour Generators.

### 10.1 RETURN TO ZERO.

Normally, the Contour Generators, if retriggered during the attack segment, start from the existing voltage level. With this switch on, the attack segment will always reset to zero volts.

### 10.2 UNCONDITIONAL CONTOUR.

With this switch off, the Contour Generators will go into their release states (if the RELEASE SWITCH [10.4] is on or the RELEASE FOOTSWITCH [15.1] is depressed) only when you let up on a key. With the switch on, when you let up on a note, the Contour Generators will go through their entire attack phase and then jump immediately into the release state.

### 10.3 KEYBOARD FOLLOW.

When this switch is on, the voltage from the keyboard varies the attack, decay and release times of the Contour Generators. The lower you play, the longer the times; the higher you play, the shorter the times.

### 10.4 RELEASE.

Turns the release segment of the Contour Generators on and off. This control interacts with the RELEASE FOOTSWITCH (15.1).

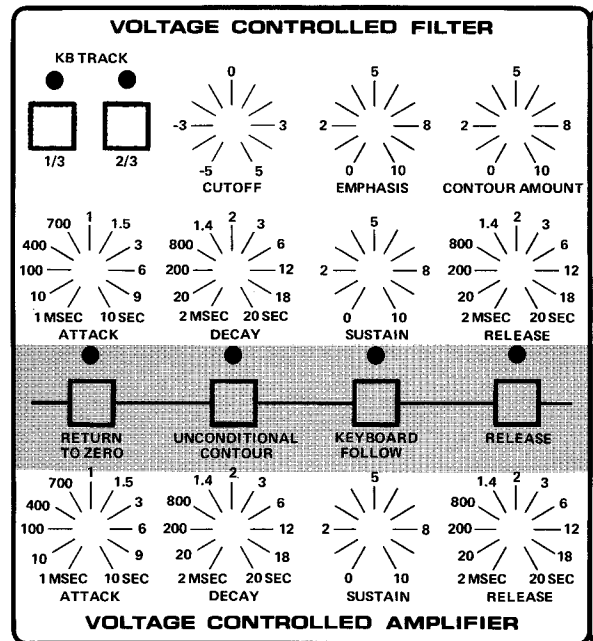
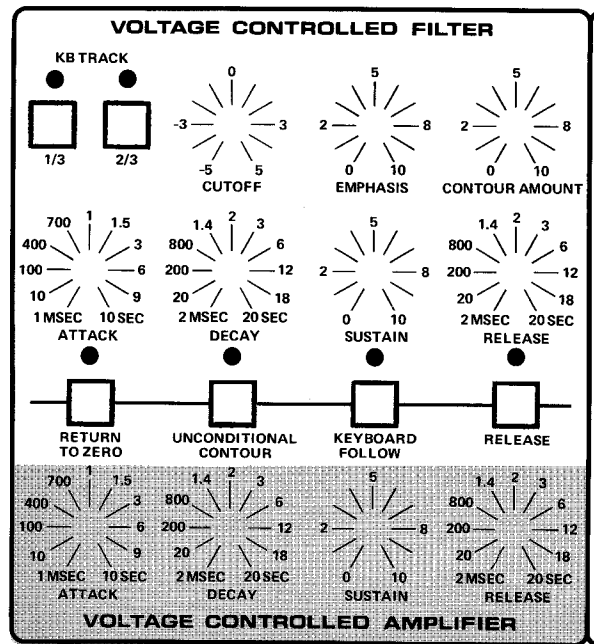



## 14.0 EXTERNAL SYNTHESIZER OUT.

### 14.1 CONTROL VOLT 1 VOLT/OCT.

A 1 volt-per-octave ( $\pm 10\%$ ) output for controlling an external synthesizer or synthesizer accessory. Range and scale trimmers for tuning the output to an external synthesizer are accessible through the rear panel.

### 14.2 V-GATE 0 - 15V.

A voltage gate output with a level of from 0 to 15 volts for interfacing with instruments which accept voltage gates.

### 14.3 S-TRIG 15V TO 0.

A switch trigger output with a range of 15 volts to 0 volts. For interfacing to instruments with switch trigger inputs.

## 15.0 FOOTSWITCH IN.

### 15.1 RELEASE.

Accepts a switch input for turning the release portion of the Contour Generators on and off (see 10.4). With the RELEASE switch on the front panel on, depressing the RELEASE FOOTSWITCH will turn the RELEASE switch on the panel off. At that point, the RELEASE FOOTSWITCH will act as a SUSTAIN PEDAL would on a piano: pressed down, the RELEASE function of the CONTOUR GENERATORS (8.5 and 9.0) will be on; let up, the RELEASE function of the CONTOUR GENERATORS will be off.

## 15.2 HOLD.

A switch input for turning the HOLD function (1.8) on and off.

## 15.3 PROGRAM ADVANCE.

A switch input for advancing through the PROGRAM SEQUENCES (3.7).

## 15.4 PROGRAM BACKSTEP.

A switch for stepping through the PROGRAM SEQUENCES (3.7) in reverse order.

## 15.5 GLIDE.

Turns the front panel GLIDE switch on or off.

## 15.6 CLOCK IN.

Replaces the internal clock from the LFO (5.0) with an external clock.

## 16.0 CASSETTE INTERFACE.

Connections are made from the three jacks to a cassette recorder for transfer of memory contents to and from tape.

## 17.0 POWER ON/OFF.

Turns the Memorymoog on and off.

## 18.0 POWERCORD.

A detachable cord is supplied with your instrument. Be careful to grasp it by the plug when taking it out of an electrical outlet.

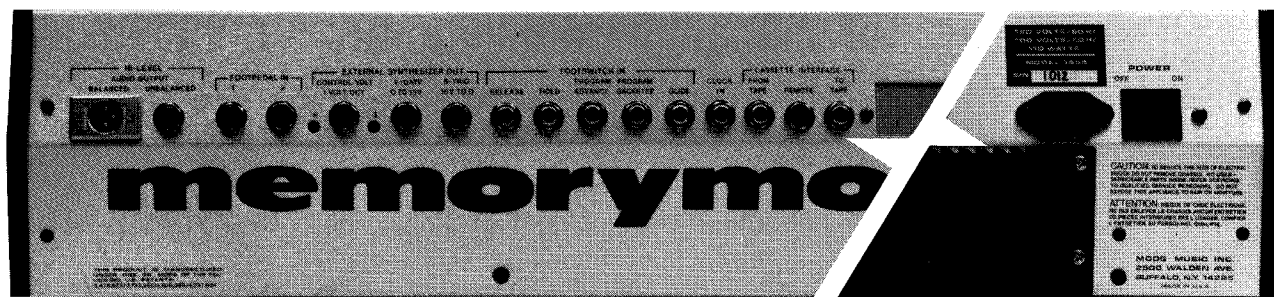

BACK PANEL

## SECTION III

### THE SYSTEM CONTROLLER

The SYSTEM CONTROLLER is the heart of the Memorymoog. Of all the front panel controls, you'll find yourself using the SYSTEM CONTROLLER most frequently. It is used to store and recall patches, set up keyboard modes, set up arpeggiation modes, control program sequencing, access the cassette interface, and many other present and future functions.

When you first power up the Memorymoog, you'll notice that the number 1 appears in the large LED display labeled PROGRAM. This tells you that program #1 is called up and ready to play. This window, the PROGRAM DISPLAY (3.1), will always show which program is currently called up and ready to play, or which program is about to be entered.

As discussed in the quick setup guide, let your instrument warm up for about 10 minutes, press the AUTO TUNE switch (1.1), and let the instrument tune itself before playing. After the AUTO TUNE routine is complete, program #1 will appear again in the PROGRAM DISPLAY and the appropriate LEDs for program #1 will light up. (Should you need to tune the instrument at any time after it's been warmed up, the computer will always remember the state of the panel controls just prior to the tuning routine and return to it.) The Alphanumeric Display (3.2) will read "6 TUNED" indicating that all six voice cards have been tuned successfully. If any number less than six appears you should hit AUTO TUNE again. If all six voice cards still fail to tune, try turning the instrument off for a moment. Then turn it on again and hit the AUTO TUNE switch. If all this fails, contact an authorized service center or call our factory service center for assistance.

### CALLING UP PROGRAMS

To call up a program, hit any desired number from 0 to 99 on the Numeric Keyboard (3.3) and follow it by pressing the ENTER switch.

The ENTER switch must be pressed in order for a new program to replace the one that is currently called up. The new number appears on the display immediately, but the new program is not active until the ENTER switch is pressed.

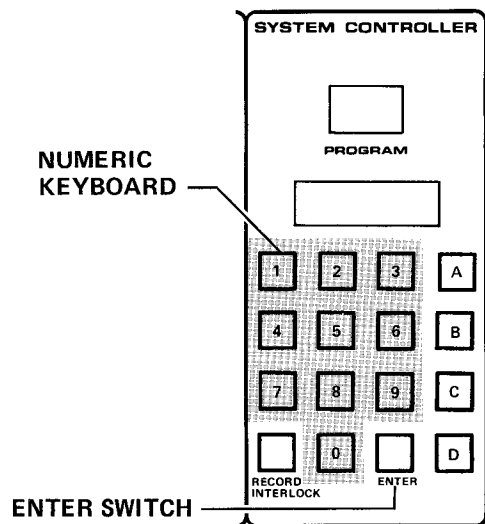
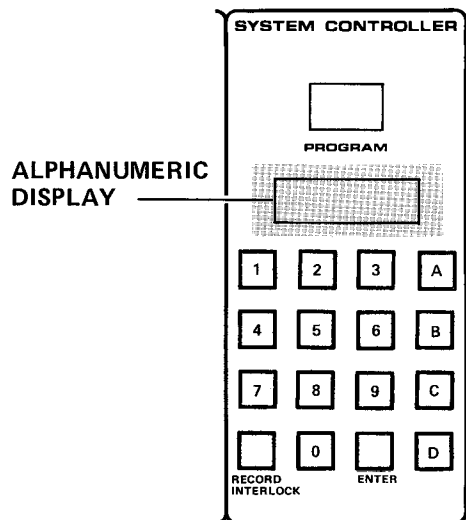
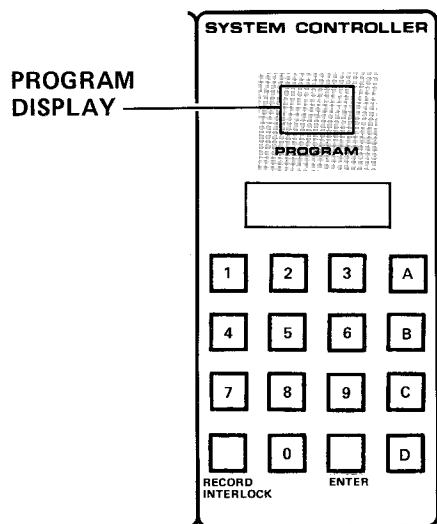

## RECORDING PROGRAMS

In order to record your own patches into the program memory you have to ENABLE the record function. To do this, press PREFIX BUTTON C (3.6), hit 8, and hit ENTER. This will display the status of the instrument. The Alphanumeric Display will read "DISABLED" or "ENABLED." Now you must enter a four-digit security code (when each instrument is shipped, the code is 0000). If you enter the wrong code, the display reads "BAD CODE" and returns to normal operation. If you enter the correct code, the instrument shows the updated status (ENABLED or DISABLED) and returns to normal operation. To change the code, hit C, hit 8, hit ENTER, then hit C again; the instrument assumes you want to change the security code and displays "OLD CODE." You enter the existing code; if the code is incorrect the display reads "BAD CODE," and operation returns to normal. If the code is correct, the display reads "NEW CODE," and you enter any new four-digit code number, followed by ENTER. A convenient code number is the last four digits of your telephone number.

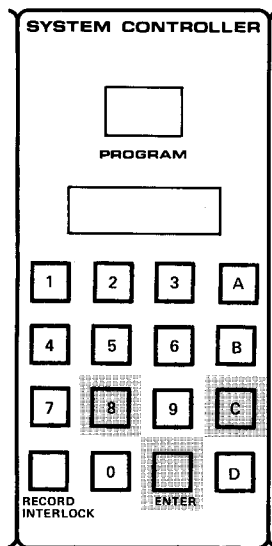

### MEMORY ENABLE/DISABLE PROCEDURE

PRESS C  
PRESS 8  
PRESS ENTER = ENABLED OR DISABLED MEMORY RECORD FUNCTION

Once you've ENABLED the memory, you're ready to store patches. The memory position you decide on should be one that has a patch you don't want, since once you record another patch over it, it's gone (unless, of course, you've stored it on cassette tape using the procedure explained a little later).

There are two ways of arriving at a patch you like: setting one up from scratch (starting from a "live panel"), or editing (changing) a prerecorded patch. To set up a live panel — one where all the controls are active, overriding the memory values — hit PREFIX C, number 9, and ENTER.

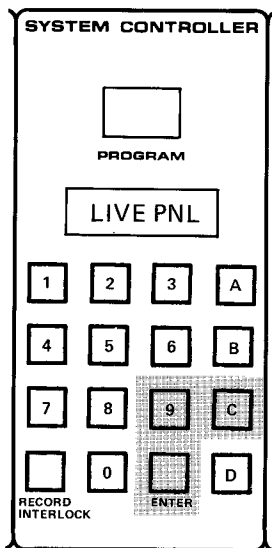

### LIVE FRONT PANEL

HIT C  
HIT 9  
HIT ENTER = LIVE PANEL

To edit or change any preset program, change any of the parameters by moving a pot or pushing a switch. When you hit a switch, you'll notice the Alphanumeric Display will read "EDIT" to tell you you've changed a parameter of the program. If you turn a pot, you'll see six numbers appear in the Alphanumeric Display. The three on the left of the screen tell you what the control's value is in memory, and the three on the right tell you the current value of the control. Note that edit changes aren't permanent changes in the memory. Hitting the ENTER switch at any time while you're editing a sound will immediately restore the patch to its original preprogrammed state. To hear this effect, call up a familiar patch. Make a few edits — changing the CUTOFF of the FILTER, or change the octave settings of the oscillators. Now hit the ENTER switch again. Everything will jump back to the way it was before you edited the sound.

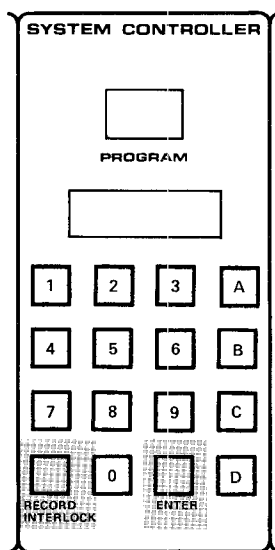

## RECORDING A PATCH

**HIT RECORD INTERLOCK AND HOLD IT  
HIT ENTER = RECORD A PATCH (EITHER FROM A  
"LIVE PANEL" OR FROM HAVING EDITED  
A PREPROGRAMMED PATCH)**

Suppose you want to record a new patch. What do you do? There are two ways to go about it: 1) Find the place you want to put it; punch that program number. Hit C, hit 9, hit ENTER to put the panel into a live state. Set up the patch the way you want it, then hit the RECORD INTERLOCK switch. This locks all the front panel controls so that moving them will have no effect at all on the patch as long as the RECORD INTERLOCK switch doesn't get hit again, cancelling the LOCK. Then while holding down the RECORD INTERLOCK switch, press the ENTER button. The Alphanumeric Display will read either "RECORDED" to indicate a successful recording, or "DISABLED" to indicate that the record function of the memory is off and must be turned on to record a patch in memory.

The other method of recording a patch involves recording edited versions of programs using the RECORD INTERLOCK switch to freeze them in temporary memory, so they can be moved to other locations or checked against the original patch. Edit a patch, hit the RECORD INTERLOCK switch to put the edited patch in temporary memory and freeze the front panel controls. Now if you hit the ENTER switch (*don't hold the RECORD INTERLOCK button down!*) you'll reinstate the original preset program. Hitting the RECORD INTERLOCK switch will bring back the edited version of the patch. This lets you do A/B comparisons between patches.

Note that you aren't limited to A/B comparisons between the edited patch and its original form. All you have to do is hit the RECORD INTERLOCK switch, putting the edited or live panel patch into temporary memory, and call up the program you want to check it against (hit a number followed by ENTER). To get the LOCKED setting back, hit the RECORD INTERLOCK switch again. If you decide you want to record the LOCKED setting into a memory position, hold the RECORD INTERLOCK switch down and hit the ENTER button. Be sure the PROGRAM DISPLAY is showing the desired program number; otherwise you'll erase a patch you may have wanted to save.

## PROGRAM SEQUENCES

The D PREFIX switch is used to call up and record PROGRAM SEQUENCES. There are 10 PROGRAM SEQUENCES in the Memorymoog. These are chains of up to 20 programs which the user determines.

To call up a PROGRAM SEQUENCE hit D, the PROGRAM SEQUENCE number (any number from 0 to 9), and hit ENTER. What you will see in the PROGRAM DISPLAY is the first program in the PROGRAM SEQUENCE. The Alphanumeric Display will look like this:

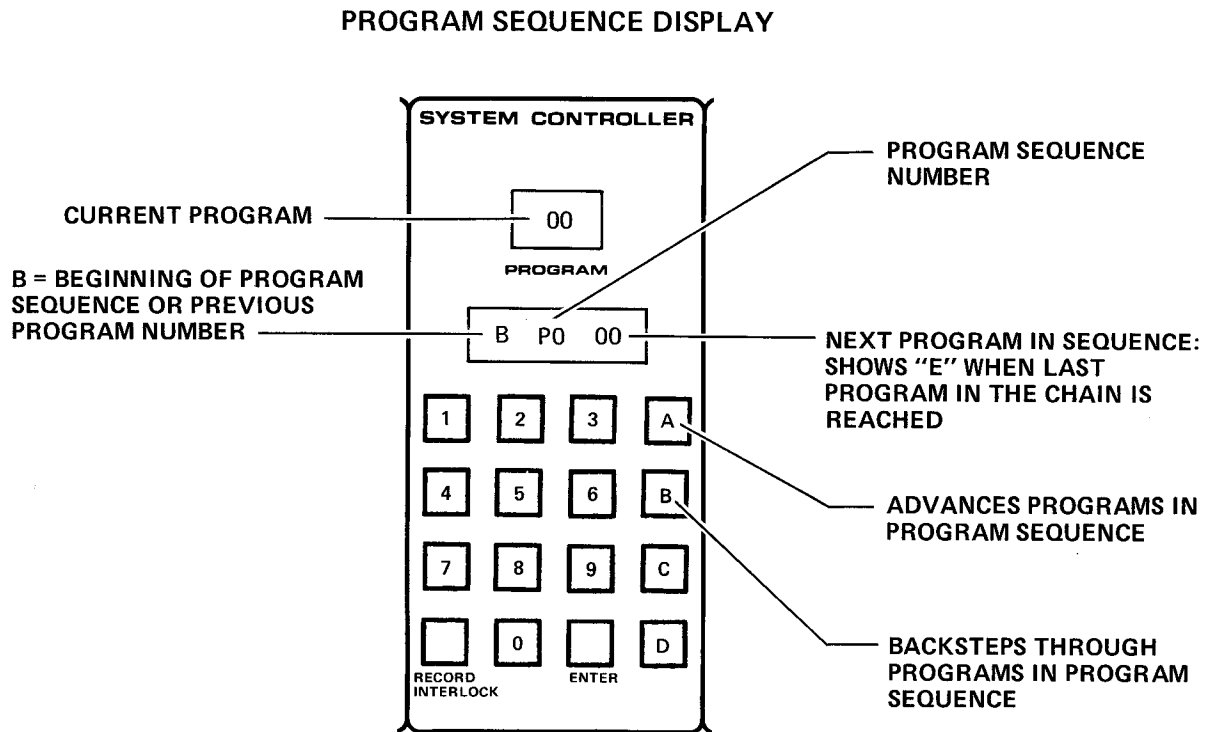

There are two possible methods for stepping forward or backward through the programs in a PROGRAM SEQUENCE. You can use the A and B PREFIX switches on the Numeric Keyboard (see diagram above) or you can use ADVANCE and BACKSTEP footswitches (not supplied with the instrument, but available as Moog accessory number 1122).

The A PREFIX switch advances (steps forward into) the PROGRAM SEQUENCE, while the B PREFIX switch backsteps through the PROGRAM SEQUENCE.

## LOADING YOUR OWN PROGRAM SEQUENCE

This process is fairly simple, but may require some practice until you get the hang of it. The procedure is as follows:

**Hit D** to get yourself into the PROGRAM SEQUENCE MODE. Then **hit D** again, putting you into LOAD MODE (an L will appear in the Alphanumeric Display). **Hit a number from 0 to 9** for the number of the PROGRAM SEQUENCE you wish to load, and then hit ENTER.

To load in the first program in the PROGRAM SEQUENCE, hit the number of the program, hit ENTER, and hit A. This will load the first program into the PROGRAM SEQUENCE. Repeat until you've either filled up the PROGRAM SEQUENCE (20 programs maximum for each SEQUENCE), or until you've got all the programs you desire to the maximum number of 20. (Putting less than 20 programs in a chain is possible.)



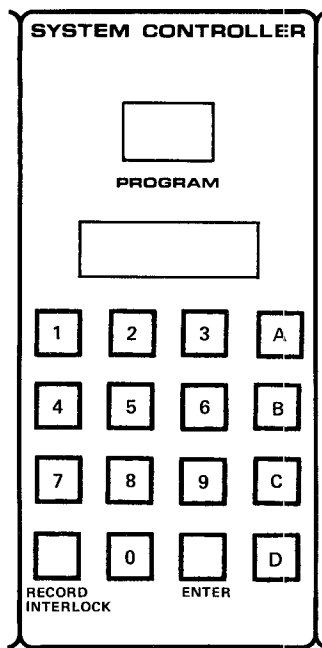

- HIT D
- HIT D
- HIT A NUMBER FROM 0 TO 9
- HIT ENTER = LOADING MODE
- HIT #
- HIT ENTER
- HIT A
- HIT ENTER = LOAD A PROGRAM FORWARD INTO PROGRAM SEQUENCE
- HIT #
- HIT ENTER
- HIT B
- HIT ENTER = LOAD A PROGRAM BACKWARD INTO PROGRAM SEQUENCE

Should you decide that you want to replace a program in the SEQUENCE, you can step through the chain to the program you want to replace and repeat the steps above for recording a program into the SEQUENCE. This will update the PROGRAM SEQUENCE.

Using the B PREFIX switch in place of the A PREFIX switch in the above loading procedure will cause the programs to be loaded into the previous position rather than in the position shown.

Here's a hypothetical PROGRAM SEQUENCE and the procedure for loading it for you to practice on:

The SEQUENCE we want runs programs 10, 20, 30, 40, 50, 60, 70.

To load it proceed thus:

- 1) Hit D
- 2) Hit D again
- 3) Hit 0 = load PROGRAM SEQUENCE 0.
- 4) Hit 10
- 5) Hit ENTER
- 6) Hit A = load first program into first position of SEQUENCE 0.
- 7) Hit 20
- 8) Hit ENTER
- 9) Hit A = load second program into second position of SEQUENCE 0.

**CONTINUE** until you've loaded all the programs into the SEQUENCE. To stop loading PROGRAM SEQUENCE 0, hit D again. This will get you out of PROGRAM SEQUENCE MODE. Hitting D, 0, ENTER will recall PROGRAM SEQUENCE 0. Step through it to see if it's correct. The SEQUENCE should run 10, 20, 30, 40, 50, 60, 70. If it doesn't, try to correct your mistake. Correcting mistakes is a great way to familiarize yourself with the operation of the PROGRAM SEQUENCE MODE.

Note that if you should need to run more than 20 programs in a PROGRAM SEQUENCE, the PROGRAM SEQUENCE automatically jumps to the next PROGRAM SEQUENCE number when it has reached the end of a SEQUENCE. Step through to the end of PROGRAM SEQUENCE 0 (an E will appear in the right side of the Alphanumeric Display) and keep going. It will run to PROGRAM SEQUENCE 1. If you step through PROGRAM SEQUENCE 0 backwards (using either the B PREFIX switch or the BACKSTEP footswitch) it will jump to PROGRAM SEQUENCE 9.

## THE CASSETTE INTERFACE

This is used to store information from the memory onto cassette tapes, expanding your library of patches beyond the 100 that the Memorymoog will hold. To access the interface, it's necessary to connect the cassette properly.

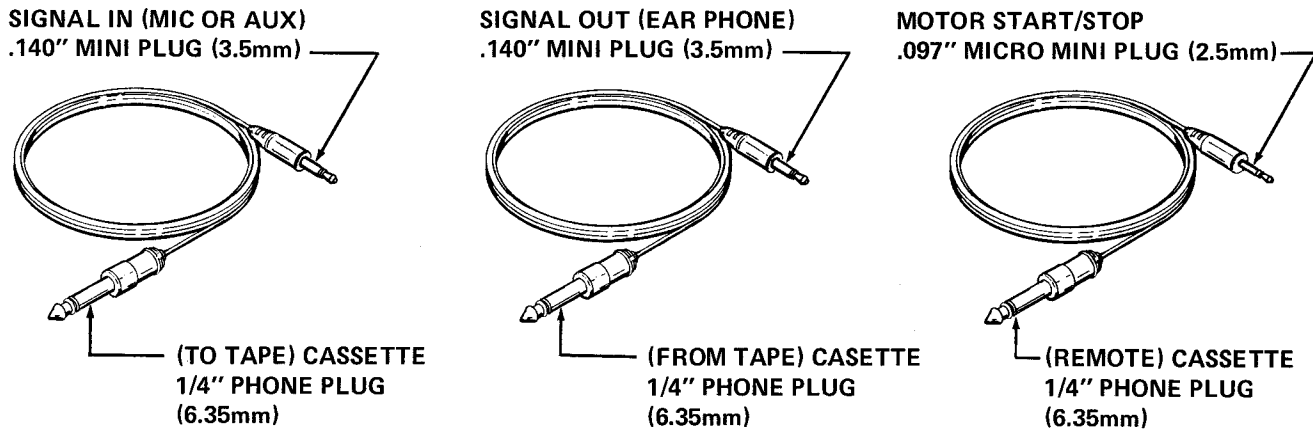

Connect the Memorymoog TO TAPE output to the MIC level input of the recorder. (Use only one channel of a stereo recorder.) Connect the Memorymoog FROM TAPE input to the EARPHONE (or line level) output of the recorder and, where applicable, connect the Memorymoog REMOTE jack to the REMOTE or START/STOP input of the recorder. If your recorder is not so equipped, start/stop must be done manually.

If you don't have a small cassette tape recorder with automatic level control, there is a leader signal at the front of the cassette save function which you can use to set the level of your recorder. It should be set at around  $\pm 3$  on the VU meter to ensure sufficient level.

To save programs onto tape, hit PREFIX C, press 1, press ENTER. This starts the cassette save operation, which takes about 30 seconds. When saving to tape, your instrument is inoperative. When it's complete, the Alphanumeric Display will read "SAVED."

To verify that saving took place correctly, rewind the tape and press PREFIX C, hit 3, hit ENTER, and start the tape. When the tape has been completed, the Alphanumeric Display will read "VERIFIED" if the tape has been made properly. It will read "ERROR" if there's a problem. If the playback volume is too low, the Display will read "VOL LOW."

To load programs from a cassette tape, press PREFIX C, hit 2, hit ENTER. When the tape has been completed, the Alphanumeric Display will read "LOADED" if there wasn't any problem. It will read "VOL LOW" if the playback volume is too low, and it will read "ERROR" if there's some other problem. Generally speaking, you should always verify a tape before you try to load it.

## INTERFACING THE MEMORYMOOG TO A MONOPHONIC SYNTH

It's possible to control an external monophonic synthesizer using the INTERFACE jacks (14.0) provided on the Memorymoog's back panel.

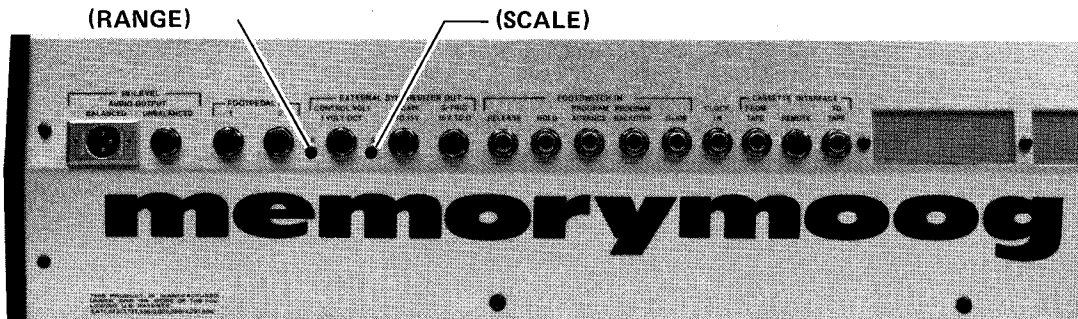

BACK PANEL

The CONTROL VOLT 1 VOLT/OCT jack is used to supply control voltage out from the Memorymoog to the external synthesizer. The other two jacks — V-GATE 0 TO 15V and S-TRIG 15V TO 0 — are used to supply either voltage or switch triggers from the Memorymoog to the external synthesizer, depending on which type of trigger signal it requires. Consult the owner's manual for the synthesizer you intend to interface to for details of the trigger signal required.

Once you've connected the necessary patch cords between instruments, it may be necessary to retune the Memorymoog output to the external synthesizer, especially if that synthesizer has a keyboard that ends in notes other than C. To do this, use the RANGE (R) and SCALE (S) trimpots on the back panel of the Memorymoog. The RANGE control lets you tune the Memorymoog output  $\pm$  an octave. Hit the lowest C on the Memorymoog, and tune it to the lowest C on the instrument you're interfacing to. The SCALE trimpot is used to tune the outer range of the Memorymoog output to the outer range of the instrument you're interfaced with. Hit the highest note on the Memorymoog and adjust the SCALE trimmer until it's in tune with the external synth. You may have to go back and forth between the RANGE and SCALE controls a bit before the instruments are exactly in tune with each other.

The KB OUT switch (1.5) on the front panel is used to disconnect the external synthesizer from the Memorymoog without unplugging all the patch cords. Its function is programmable.

## THE KEYBOARD

The keyboard is the source of control voltages that are applied to the oscillators, telling them what pitches to produce. The lower the note you play, the lower the corresponding voltage the keyboard will put out. It functions in two basic modes: POLYPHONIC and MONOPHONIC.

In its four POLYPHONIC MODES you can play up to six notes simultaneously. The keyboard puts out a separate control voltage for each voice card. There are four different ways that the computer assigns voices to the notes you play when you're in a POLYPHONIC mode. The effects of the different keyboard modes will not be apparent unless glide and/or long release times are turned on. To hear the various keyboard modes, use a fairly straight preset, a brassy one or something similar. Turn the GLIDE (1.6) on and set it at 5 or more. To set the mode of the keyboard, hit the KB MODE switch (1.7). The Alphanumeric Display (3.2) will then show "POLYPHONIC 1, 2, 3, or 4" depending on the keyboard mode programmed. Hit 1 on the Numeric Keyboard (3.3) followed by ENTER. This puts you in KEYBOARD MODE 1, which is called CYCLIC indicating that the voices will jump around to new notes every time one is played. Hitting a widely spread chord on the keyboard more than once, letting the glide finish its cycle, will let you hear that no matter how many times you strike the chord, each voice has glide on it.

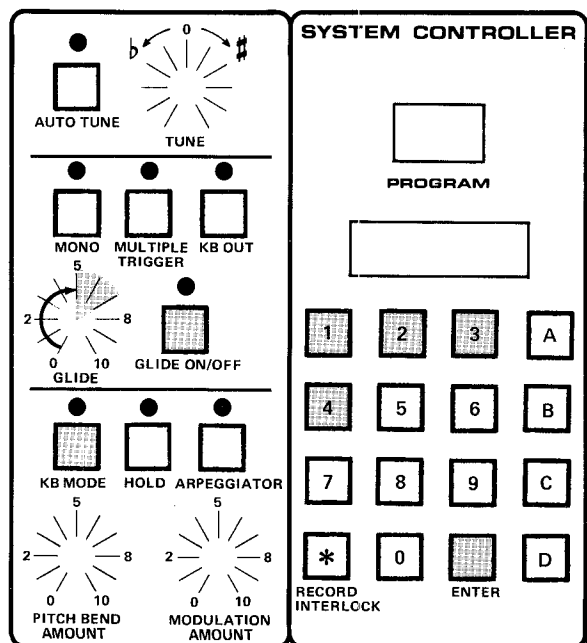

## POLYPHONIC KEYBOARD MODES

- HIT KB MODE
- HIT 1
- HIT ENTER = KB MODE # 1
- HIT KB MODE
- HIT 2
- HIT ENTER = KB MODE # 2
- HIT KB MODE
- HIT 3
- HIT ENTER = KB MODE # 3
- HIT KB MODE
- HIT 4
- HIT ENTER = KB MODE # 4

Next, hit KB MODE, hit 2, hit ENTER. That will put the keyboard in POLYPHONIC MODE 2, CYCLIC WITH MEMORY. Now when you repeat the same chord over and over again, you should only hear glide the first time you strike the chord. The second and each consecutive time you strike that chord, the computer memory remembers that the voices have been assigned to the various pitches you are playing. It won't reassign them until you hit a new note or set of notes.

Hit KB MODE, hit 3, hit ENTER. This gets you to KEYBOARD MODE 3, RESET TO VOICE A. Every time you let up on all the notes on the keyboard, the next note you hit will be assigned to VOICE A. Playing a single line will produce a sound similar to playing the same line on a monophonic synthesizer.

Hit KB MODE, hit 4, hit ENTER to hear KEYBOARD MODE 4, RESET TO VOICE A WITH MEMORY. The effect is just like that of CYCLIC WITH MEMORY in that when you strike the chord repeatedly, you only hear glide the first time you hit the chord. From then on the instrument remembers that the voices have been assigned specific notes and it won't reassign them until you strike new notes. This mode differs from CYCLIC WITH MEMORY in that the first note played after no notes have been held down is assigned to VOICE A.

In MONOPHONIC MODE, the keyboard will only let you play one note at a time. There are three different MONOPHONIC PRIORITY modes that determine what note sounds should you play more than one note at a time when in MONO MODE. To get to the MONOPHONIC KEYBOARD MODES, turn the MONO switch (1.3) on. Then hit the KB MODE switch (1.7), and press either 1, 2, or 3, followed by ENTER. KEYBOARD MODE 1 is last note priority – the last note played will sound over all others no matter how many notes you hold down. KEYBOARD MODE 2 is low-note priority – the lowest note played gets priority. KEYBOARD MODE 3 is high-note priority – the highest note will sound if more than one note is played. All three modes have interesting uses, especially when used in conjunction with the SINGLE/MULTIPLE TRIGGER switch (1.4) and/or when the Memorymoog is interfaced with a monophonic synthesizer.

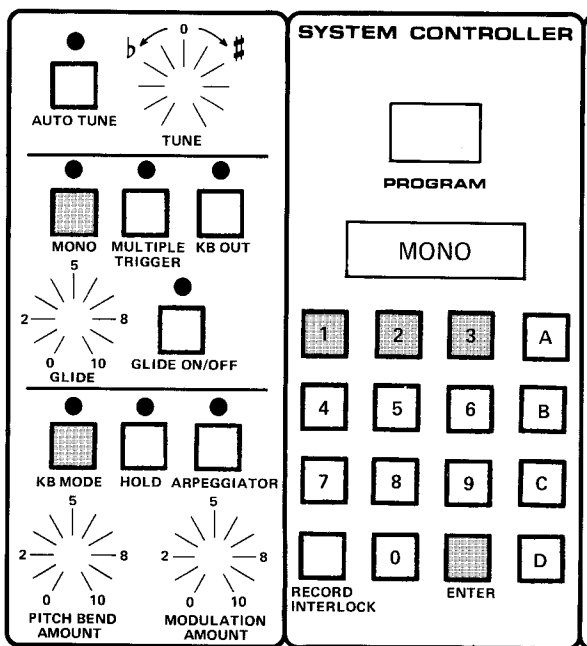

## MONOPHONIC KEYBOARD MODES

- HIT KB MODE  
HIT 1  
HIT ENTER = KB MODE # 1
- HIT KB MODE  
HIT 2  
HIT ENTER = KB MODE # 2
- HIT KB MODE  
HIT 3  
HIT ENTER = KB MODE # 3

## CHANGING THE NUMBER OF VOICES THE KEYBOARD CONTROLS IN MONO MODE

When you put the keyboard into its MONOPHONIC MODE by pressing the MONO switch (1.3), the keyboard will play only one note at a time. It will control from 1 to 18 oscillators, depending on how many voice cards are being controlled. You can program the number of voice cards controlled by turning the MONO switch (1.3) on, hitting the KB MODE switch (1.7), pressing ENTER, and then hitting a number from 1 to 6 on the Numeric Keyboard (3.3), and pressing ENTER again. If you hit a 1, you will control three oscillators as a Minimoog does. If you want to hear the sound of only one oscillator, turn the volume controls in the MIXER (7.0) of two of the oscillators to 0. The more oscillators you control, the thicker and fatter the sound will be. Controlling all 18 oscillators in unison creates a very massive sound.

## SINGLE/MULTIPLE TRIGGER

When the SINGLE/MULTIPLE TRIGGER switch (1.4) is off, the keyboard waits until all keys are released before a new key depression will put out a new trigger signal, which is used to start the CONTOUR GENERATORS (8.5 and 9.0). This state is called SINGLE TRIGGERING, and it's useful for playing legato passages in MONO MODE.

You can emphasize phrases in SINGLE TRIGGER MODE by deliberately attacking only the first note in a phrase, playing the rest of it with a legato touch. This produces only one trigger for the entire phrase, emphasizing the first note, letting the others be played with what remains of the single CONTOUR. If you've never played a single-trigger monophonic synthesizer before, it may take some practice to get used to the technique. With this patch try playing a familiar run or scale, producing new triggers only at the first note. Do it slowly to begin with and increase the speed as you start to master the technique. Also, try the different KEYBOARD MODES while you practice and notice the differences in priority between high-note, low-note, and last-note modes.

## SINGLE/MULTIPLE TRIGGER

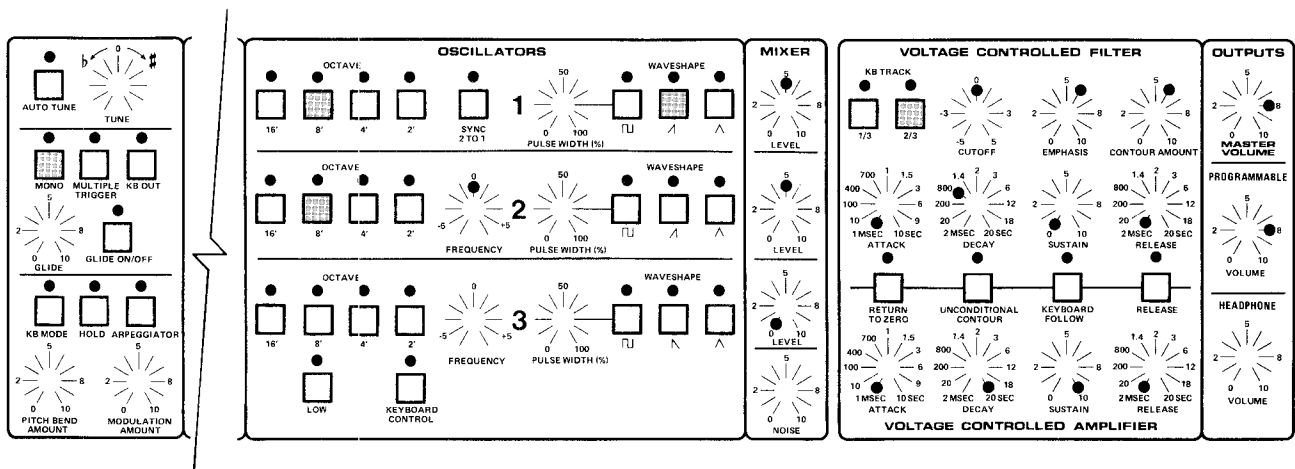

With the SINGLE/MULTIPLE TRIGGER switch (1.4) on, the keyboard will put out a new trigger for every note played, regardless of whether or not any other note is still being held down. You'll notice that if you try to play legato, the keyboard will still put out new triggers, foiling your every attempt to avoid them. MULTIPLE TRIGGERING is great for playing those pyrotechnic runs where you want every note to stand out. It covers up for any note you hit sloppily, whereas with SINGLE TRIGGERING, you have to be sure to hit every note distinctly in order for it to be articulated clearly.

## THE HOLD FUNCTION

The HOLD switch (1.8) is used for building chords that you can subsequently control in parallel motion from the keyboard. Play a chord. Continue holding it while you press the HOLD button. Let up on the chord and then play a single note. You should hear the chord and be able to transpose it up and down by playing the keyboard. If you want to build chords that are too wide to simultaneously play while pressing the HOLD switch, push the HOLD switch, continue holding it and play the chord you want, one note at a time. When the HOLD switch is released, the chord pattern is stored. Since the HOLD function is *not* programmable, you can switch to other programs while retaining the "held" chord.

## THE ARPEGGIATOR

Turning the ARPEGGIATOR switch (1.9) on puts the keyboard immediately into a MONOPHONIC ARPEGGIATION MODE. However, if the instrument is in MONOPHONIC MODE already, no arpeggiation will occur. You'll hear the highest, lowest, or last note you've hit retrigger depending on the MONO KEYBOARD MODE you're in. The rate of the arpeggiation is set by the LFO RATE knob (5.0).

When you first turn on the arpeggiator, the Alphanumeric Display will read "MODE (1 - 9)" (the arpeggiation modes are listed below). To change the ARPEGGIATION MODES, hit the desired MODE NUMBER followed by ENTER immediately after you turn on the ARPEGGIATOR.

## ARPEGGIATION MODES

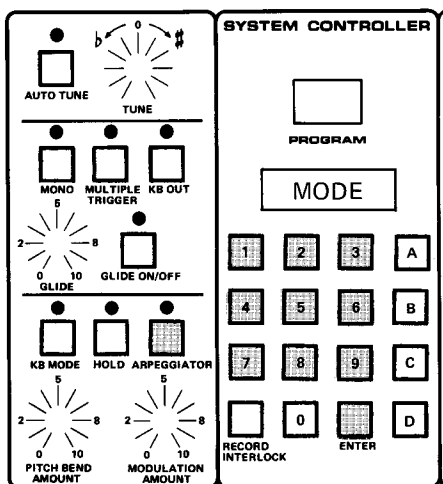

### TURN ARPEGGIATOR ON



- HIT 1
- HIT ENTER = MODE 1, UP
- HIT 2
- HIT ENTER = MODE 2, DOWN
- HIT 3
- HIT ENTER = MODE 3, UP-DOWN
- HIT 4
- HIT ENTER = MODE 4, UP (LATCHED)
- HIT 5
- HIT ENTER = MODE 5, DOWN (LATCHED)
- HIT 6
- HIT ENTER = MODE 6, UP-DOWN (LATCHED)
- HIT 7
- HIT ENTER = MODE 7, AUTO TRIGGER (ALL VOICES TRIGGERED SIMULTANEOUSLY)
- HIT 8
- HIT ENTER = MODE 8, FIRST-TO-LAST
- HIT 9
- HIT ENTER = MODE 9, FIRST-TO-LAST (LATCHED)

## THE OSCILLATORS

The 18 voltage-controlled oscillators of the Memorymoog produce the pitches you hear when you play the keyboard. The control voltage output from the keyboard determines the oscillators' pitch. Pitch is supplied by an oscillator when its waveform, a periodic fluctuation of voltage, is translated by a speaker cone into a fluctuation of air, which we perceive as pitch. There are a number of things which can alter the speed or frequency of the oscillators: incoming control voltages supplied by the keyboard, the FREQUENCY controls on the oscillators themselves (6.5 and 6.6), voltage from the two PROGRAMMABLE FOOTPEDALS (4.0), the PITCH BEND WHEEL (2.2), the LFO (5.0), the filter's CONTOUR GENERATOR (8.5), and the output of OSCILLATOR 3 when it's used as a modulation source in the VOICE MODULATION section (5.4).

As we explained in the introduction, each voice card holds three oscillators. There are six voice cards for a total of 18 oscillators. Each of the oscillator panel controls for OSCILLATORS 1, 2, and 3 actually governs six oscillators. To avoid confusion when we refer to OSCILLATOR 1, OSCILLATOR 2, and OSCILLATOR 3, we'll mean the set of six oscillators governed by each of those groups of controls.

## WAVESHAPES

Each oscillator generates three waveshapes: pulse , sawtooth , and triangle . Each waveshape is a representation of fluctuations of voltage. These fluctuations produce different sets of harmonics, thereby creating a different timbre of tone color. If you want to listen to how they differ, set up this patch (start by pressing C, 9, ENTER on the NUMERIC KEYBOARD [3.3] to get a live panel):

### TO HEAR THE DIFFERENT WAVESHAPES . . .

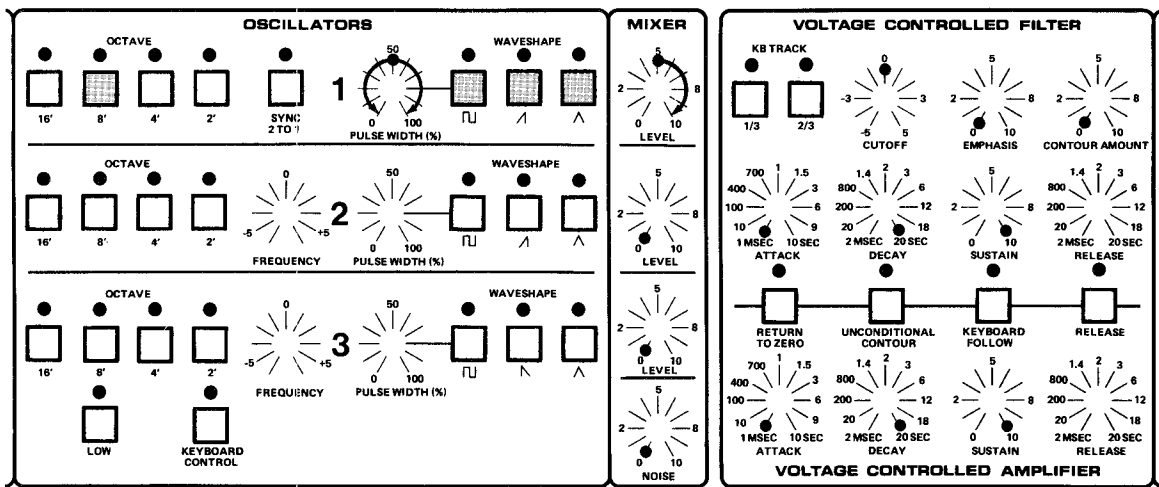

**HOLD DOWN A NOTE IN THE CENTER OF THE KEYBOARD. TURN ON EACH WAVESHAPESwitch INDIVIDUALLY AND LISTEN TO THE EFFECT IT HAS ON THE TONE COLOR. TURN THE PULSE WIDTH CONTROL WHEN YOU GET TO THE PULSE WAVE AND NOTICE HOW CHANGING THE WIDTH OF THE PULSE WAVE AFFECTS ITS TONE.**

Play a note on the middle of the keyboard and turn on the WAVESHAPE switches (6.4), one at a time. You'll notice that the triangle waveshape is soft and flute-like. That's because it has a simple harmonic content. The sawtooth wave is bright because it has all harmonics. It's good for producing brass- and string-like sounds. The pulse wave has a variable width. When you listen to it, move the PULSE WIDTH control (6.3) across its full range. You'll notice that at 0% the width gets so thin that the waveshape becomes inaudible. You can use this effect to advantage when you apply modulation from either the LFO (5.0) or the VOICE MODULATION section (5.4) to the pulse width of any of the oscillators, causing the oscillator to fade in and out. The pulse wave can sound anywhere from hollow to thin and nasal depending on how its width is set. It's useful for pipe organ sounds, strings, reeds, and so on.

You've probably noticed that you can mix the different waveshapes by turning the switches on simultaneously. This produces more complex waveshapes. Different waveshapes can also be produced by turning the MIXER level controls (7.0) up past 5. This causes clipping distortion. It can turn the triangle waveshape into a sine wave, which has no harmonics at all and is very flutey sounding.



**NORMAL TRIANGLE WAVESHAPE**

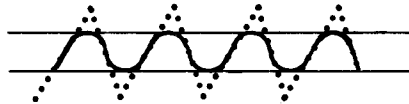

**"CLIPPED" TRIANGLE/SINE WAVESHAPE**

### SYNC 2 TO 1

SYNC is short for synchronize. When the SYNC switch (6.2) is on, the fundamental frequency of OSCILLATOR 2 is locked to the fundamental frequency of OSCILLATOR 1. To hear the effect, start with the same live panel patch we used to hear waveshapes, but turn on the SYNC switch and turn up the volume of OSCILLATOR 2 and turn down the volume of OSCILLATOR 1 using the MIXER controls (7.0).

### HEARING SYNC

The diagram shows a synthesizer control panel with the following sections:

- OSCILLATORS:** Three rows of controls for Oscillators 1, 2, and 3. Each row includes octave settings (16', 8', 4', 2'), a SYNC 2 TO 1 switch, a PULSE WIDTH (%) knob, and three waveshape switches (square, triangle, sawtooth).
- MIXER:** Four level knobs for Oscillator 1, Oscillator 2, Oscillator 3, and Noise, each with a scale from 0 to 10.
- VOLTAGE CONTROLLED FILTER:** A section with four knobs: CUTOFF (0 to 10), EMPHASIS (0 to 10), CONTOUR AMOUNT (0 to 10), and SUSTAIN (0 to 10). Below these are four switches: RETURN TO ZERO, UNCONDITIONAL CONTOUR, KEYBOARD FOLLOW, and RELEASE. At the bottom are four knobs for ATTACK, DECAY, and RELEASE times, each with a scale from 1MSEC to 20SEC.

**TURN THE FREQUENCY CONTROL TO OSCILLATOR 2 ACROSS ITS FULL RANGE TO HEAR THE EFFECT OF SYNCING OSC 2 TO OSC 1.**

**TRY CHANGING THE OCTAVE SETTINGS OF OSCILLATOR 2. YOU'LL NOTICE THAT THE MORE REMOVED THE OCTAVE IS FROM OSCILLATOR 1, THE MORE PRONOUNCED THE SYNC EFFECT.**



Hold a note in the middle of the keyboard and turn the outer ring of the FREQUENCY controls (6.5) for OSCILLATOR 2. Experiment with changing the octave settings of both OSCILLATOR 1 and OSCILLATOR 2. Remember that in this patch, you're only listening to the output of OSCILLATOR 2. By turning up the MIXER level controls to OSCILLATOR 1, you'll hear its output in addition to that of OSCILLATOR 2.

Interesting things start happening when you apply control voltages from a VOLTAGE PEDAL (4.0), the LFO (5.0), and/or the VOICE MODULATION section (5.4) to the frequency of OSCILLATOR 2 when it's synced to OSCILLATOR 1.

## FREQUENCY CONTROLS

OSCILLATOR 2 and OSCILLATOR 3 both have controls (6.5 and 6.6) that let you detune them  $\pm$  a minor sixth from OSCILLATOR 1. These FREQUENCY controls are set up concentrically: the outer ring is used for large tuning adjustments and the inner ring is for fine tuning adjustments. With these tuning controls you can do things like play triads from each single note on the keyboard, tuning OSCILLATOR 2 and OSCILLATOR 3 to a third and a fifth above OSCILLATOR 1. You can achieve compound intervals like ninths, tenths, and thirteenthths by raising the octave setting of the OSCILLATOR after you've tuned it up to a second, third, or sixth using the OCTAVE switches (6.1).

To hear the effects of the FREQUENCY controls, go back to the live panel patch we've been working with and turn up the levels of OSCILLATORS 1 and 3 and turn off the SYNC switch. Then experiment with tuning the different oscillators to various intervals. Change the octave settings too.

## THE FREQUENCY CONTROLS

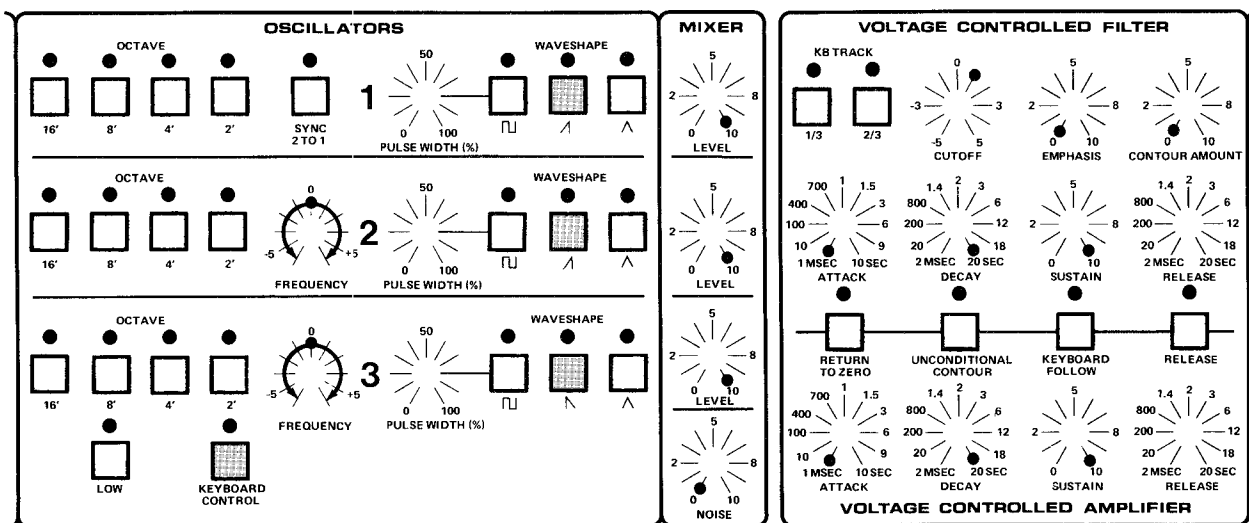

EXPERIMENT WITH DIFFERENT OCTAVE SETTINGS AND DIFFERENT WAVESHAPES SETTINGS.

NOTICE THAT WHEN THE OUTER RING OF THE FREQUENCY CONTROLS IS TURNED, THE INNER RING SPINS AROUND, DUE TO THE FACT THAT THE INNER RING IS A FINE TUNE CONTROL.

## OSCILLATOR 3 AS A LOW-FREQUENCY OSCILLATOR

OSCILLATOR 3 differs from the other two oscillators in that it can act as a source of modulation in the VOICE MODULATION section (5.4). For this reason it's useful to be able to use OSCILLATOR 3 as a LOW-FREQUENCY OSCILLATOR (LFO). The LOW switch (6.7) converts the oscillator from an audio range oscillator to a low-frequency oscillator.

When the LOW switch is turned on, the range of the oscillator drops by about five octaves. If you leave the MIXER level control for OSCILLATOR 3 up, you'll probably hear clicks. That's because the frequency of the oscillator is too low to be perceived as pitch. (For more on the application of OSCILLATOR 3 as an LFO, see the section on VOICE MODULATION.)

Turning the KEYBOARD CONTROL switch (6.8) off turns OSCILLATOR 3 into a drone oscillator. Without any control voltage from the keyboard to vary its pitch, the oscillator will remain at one constant pitch (unless you modulate it with some other voltage source like the LFO). With the KEYBOARD CONTROL switch on, OSCILLATOR 3 will be controlled by the keyboard like OSCILLATORS 1 and 2.

## THE NOISE SOURCE

In addition to the three audio oscillators, there are two other sound sources in the Memorymoog, one of which is the NOISE SOURCE, whose level control is in the MIXER (7.0). The noise produced is *pink noise*, noise weighted to produce an equal amount of energy in each octave of the frequency spectrum. It has a deep sound and is useful for creating wind and surf effects. The other sound source is the VOLTAGE-CONTROLLED FILTER which is discussed later.

## THE MIXER

The MIXER (7.0) is fairly straightforward. Each oscillator and the NOISE SOURCE has its corresponding level control that adjusts the volume of its output signal as it is fed into the FILTER. What may not be so obvious is that starting at about 4 or 5 on each MIXER control, clipping distortion is introduced. This effect enhances sounds by making them sound audibly larger than life. For a diagram of the effects of clipping distortion, see the section above on the oscillators.

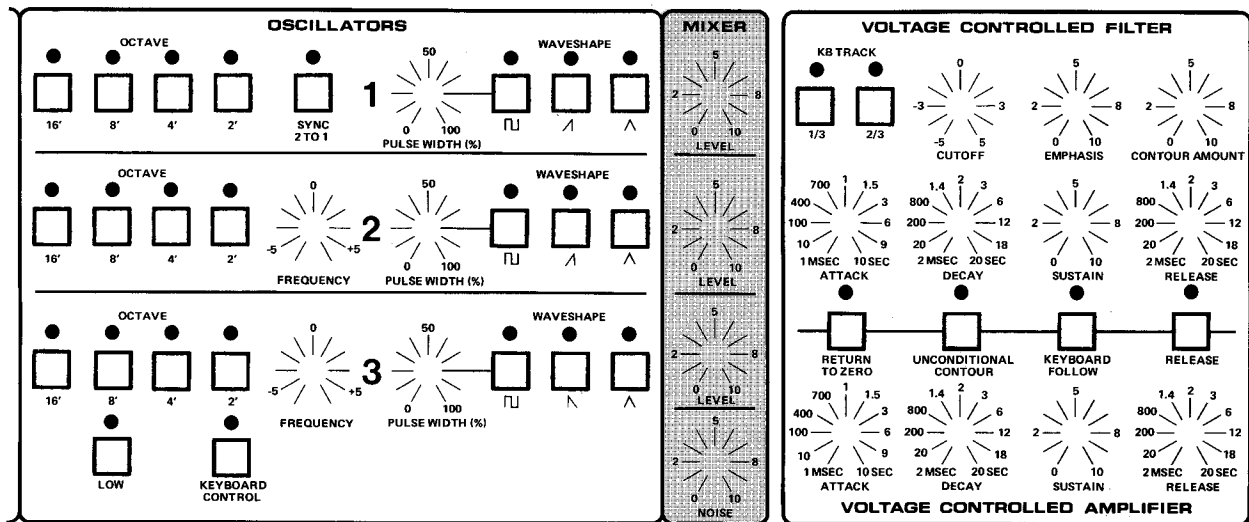

## THE VOLTAGE-CONTROLLED FILTER

The job of the FILTER is to modify the signals from the sound sources (the OSCILLATORS and the NOISE SOURCE). The FILTER in the Memorymoog is the patented Moog 24dB/octave lowpass filter. It's called a lowpass filter because it filters out — stops — high frequencies from getting through and lets low frequencies pass. The setting of the CUTOFF control (8.2) determines how many high frequencies are filtered out and how many low frequencies are let through. All of the modulation voltage sources that can be applied to the filter affect its CUTOFF frequency.

To listen to the effect that changing the CUTOFF frequency has on the timber of the various wave-shapes, set up this patch starting with a live panel:

### HEARING WHAT CHANGING THE CUTOFF FREQUENCY DOES

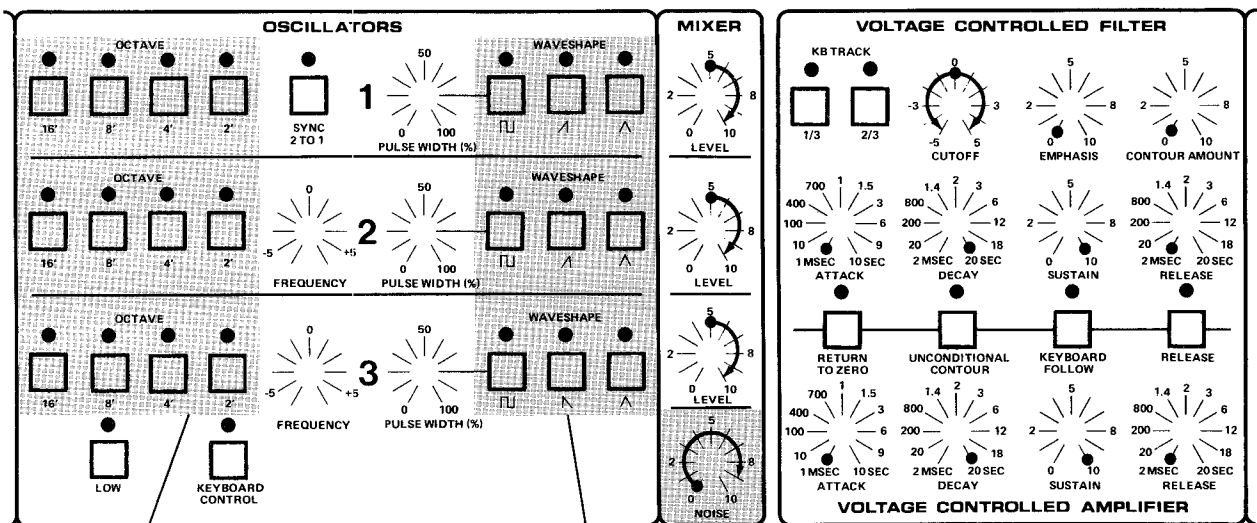

EXPERIMENT WITH CHANGING WAVESHAPES, CHANGING LEVELS, CHANGING OCTAVES.

LISTEN TO THE EFFECT THE CUTOFF FREQUENCY HAS ON THE NOISE SOURCE.

TURN CUTOFF FREQUENCY SLOWLY, LISTENING TO THE TONE OF EACH WAVEFORM.

Play a low note on the keyboard. Slowly turn the CUTOFF control, listening to the harmonics being swept. You'll notice that if you play high notes and turn the CUTOFF control down too far (counterclockwise to -3 or -5) you won't hear any sound at all. That's because the FILTER CUTOFF is below the frequencies of the note you're playing.

## EMPHASIS

Turning this control up puts a *resonant peak* at the FILTER's CUTOFF frequency. When the setting is a little past 7, the FILTER actually starts oscillating on its own, becoming another sound source. Listen to the effect of turning the EMPHASIS control (see diagram on the following page):

## EMPHASIS

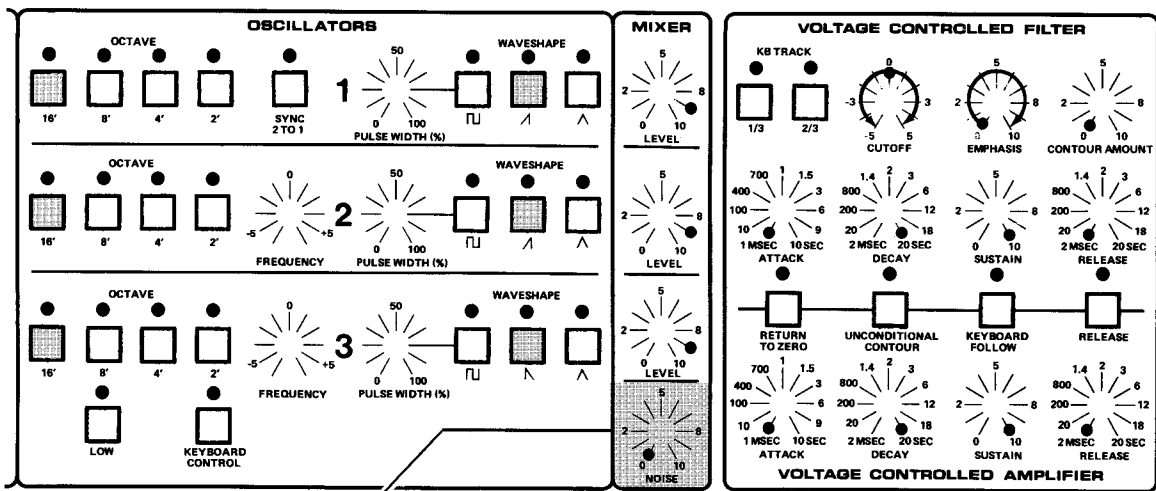

SEE WHAT EFFECT THE EMPHASIS HAS ON THE NOISE SOURCE.

HOLD A LOW NOTE ON THE KEYBOARD. TURN THE EMPHASIS CONTROL UP SLOWLY. WHEN IT'S UP PAST 5, TRY ROTATING THE CUTOFF FREQUENCY CONTROL.

Notice that changing the CUTOFF control (8.2) moves the resonant peak so that it sweeps through the harmonics of the incoming waveform.

## KB TRACK

The two KB TRACK switches (8.1) route control voltage from the keyboard to the CUTOFF frequency of the FILTER. The control voltage is added by thirds. Turning both switches on applies maximum keyboard control voltage to the CUTOFF. The keyboard control voltage is always proportionate to the location of the note you're playing on the keyboard: i.e., a low note puts out less control voltage than a high note. Experiment with adding different amounts of keyboard voltage to the filter, first using no EMPHASIS. Notice that when you turn the CUTOFF knob up beyond 0, the keyboard voltage appears to have little or no effect. That's because it is effectively opening the FILTER all the way up; there's no way the CUTOFF can open any farther for it to have any more audible effect.

An interesting thing happens when you apply the keyboard voltage in the various amounts to the filter if you have the EMPHASIS turned up past 7 – so the FILTER is oscillating. You can play the FILTER as if it were another oscillator. To try this, put the EMPHASIS up to 10, the CUTOFF on 0, and turn all the MIXER level controls (7.0) down to 0. That way, you'll only be listening to the FILTER.

## PLAYING THE FILTER

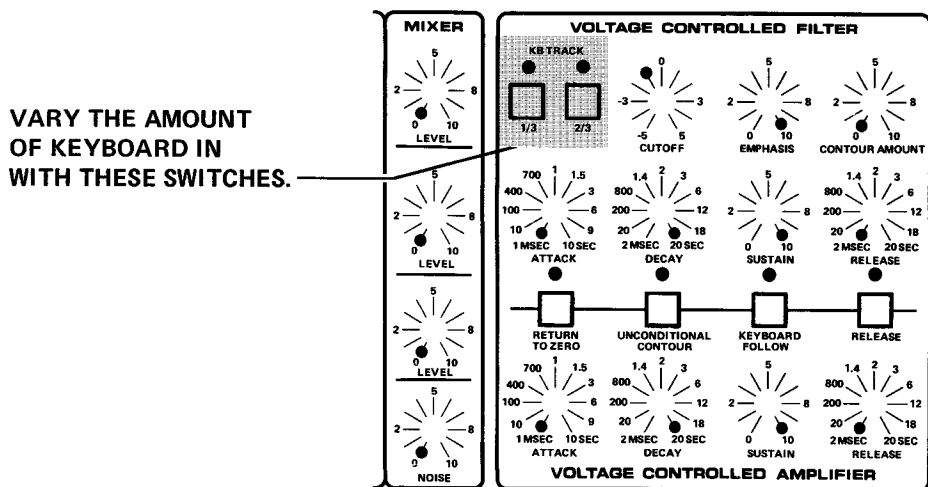

VARY THE AMOUNT OF KEYBOARD IN WITH THESE SWITCHES.

PLAY A SCALE ON THE KEYBOARD TO HEAR HOW CHANGING THE KEYBOARD CONTROL VOLTAGE ALTERS THE INTONATION.

Playing a scale on the keyboard with different amounts of keyboard voltage will show you audibly just how changing the control voltage amount affects the FILTER. The intonation will change as you vary the amount of voltage from the keyboard. Full keyboard voltage should yield a normal tempered scale.

Experiment with moving the CUTOFF control while you're playing the FILTER. Also, notice the effect of running NOISE into the FILTER when the EMPHASIS amount is up to the point of oscillation and the keyboard is controlling it: you get tuned NOISE.

## CONTOUR AMOUNT

The CONTOUR AMOUNT control (8.4) is simply an attenuator for the control voltage generated by the FILTER's CONTOUR GENERATOR (8.5), which gets applied to the CUTOFF frequency. Going back to the basic patch we've been working with, you'll notice that it's possible to mimic the effect of the CUTOFF control with the CONTOUR AMOUNT control.

## CONTOUR AMOUNT CONTROLS

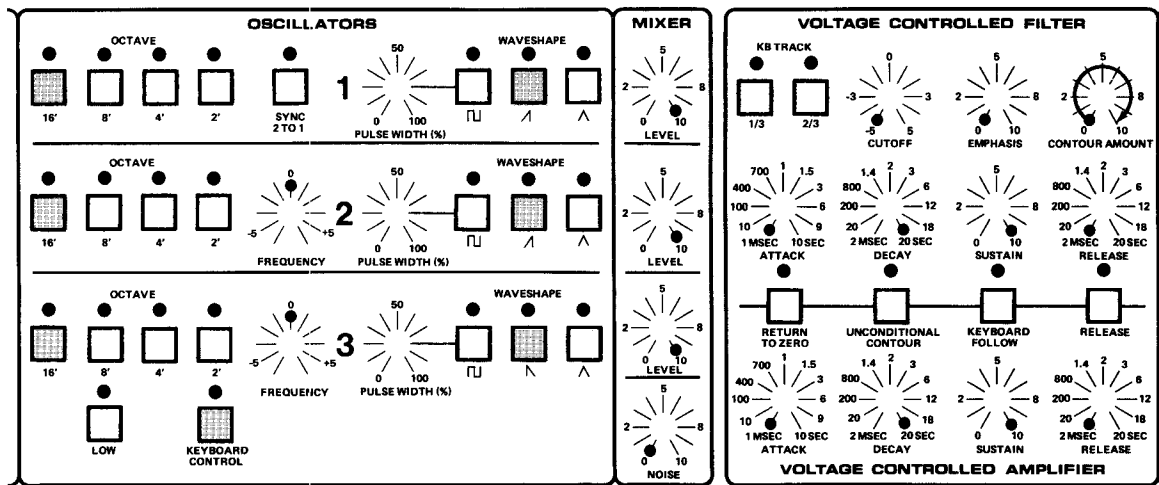

**HOLD A LOW NOTE. MOVE THE CONTOUR AMOUNT CONTROL. NOTICE THAT WITH THESE SETTINGS, IT HAS THE SAME EFFECT AS THE CUTOFF CONTROL.**

Changing the settings of the CONTOUR controls (8.5) will have a noticeable effect on this. To understand what's happening, you have to understand what the CONTOUR GENERATORS do.

## THE CONTOUR GENERATORS

As was explained in the section on the keyboard, when you play a note, a trigger signal is generated by the keyboard which is channeled to the CONTOUR GENERATORS (8.5 and 9.0). It is this trigger signal which tells the CONTOUR GENERATORS to start up. Once triggered, the CONTOUR GENERATORS put out a *dynamic* control voltage — one that varies across time. When this voltage is applied to the CUTOFF control of the FILTER, you get dynamic changes in timbre. When it's applied to the VOLTAGE-CONTROLLED AMPLIFIER (9.0), you get dynamic changes in loudness.

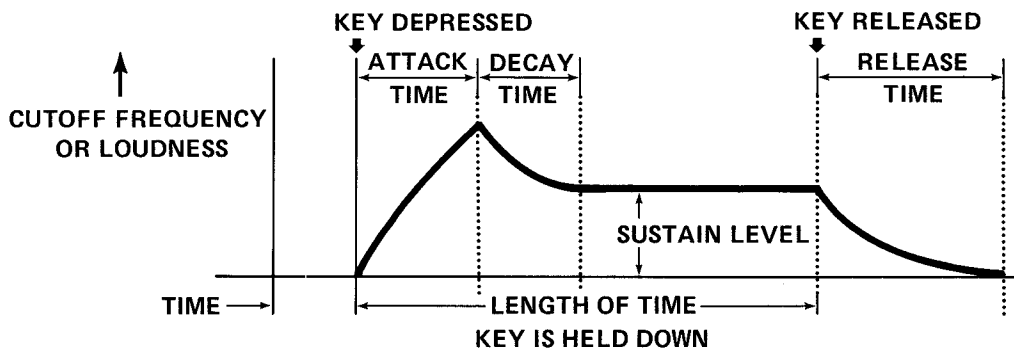

Other terms for CONTOUR GENERATOR are ENVELOPE GENERATOR, or ADSR, short for Attack, Decay, Sustain and Release — the four stages of the CONTOUR GENERATOR. As you can see from the above diagram, the attack time is the time it takes for the CONTOUR to reach its peak once a trigger signal has been received. From there the decay stage begins. Decay is the time it takes for the peak of the attack to subside to the sustain level — the level the CONTOUR maintains until the key is released. When you let up on a key, or release it, the CONTOUR goes into its release state which, depending on how the release time is set, can cause the note to ring out or cut off abruptly.

There are two ADSR CONTOUR GENERATORS in each voice of the Memorymoog. The filter contour output is applied to the CUTOFF of the FILTER. The second's output is applied to the VOLTAGE-CONTROLLED AMPLIFIER. Both ADSRs have the same characteristics: attack time is variable from 1 millisecond to 10 seconds; decay time is variable from 2 milliseconds to 20 seconds; sustain level is continuously variable from 0 to 10; and the release time is variable from 2 milliseconds to 20 seconds.

It's important to note that the RELEASE SWITCH (10.4) has to be on in order for the release portion of the CONTOUR to function. The RELEASE FOOTSWITCH (15.1) serves as a remote on/off control for the RELEASE SWITCH. It functions in the same way that a piano's sustain pedal works—down, the release is on; up, the release is off. However if the program is set up with the release on, the first time the pedal is depressed, the RELEASE will be turned off; from that point the footswitch will operate as described above. Try this patch: switch the RELEASE on and off and note the change in the sound when a key is released.

### RELEASE TIME

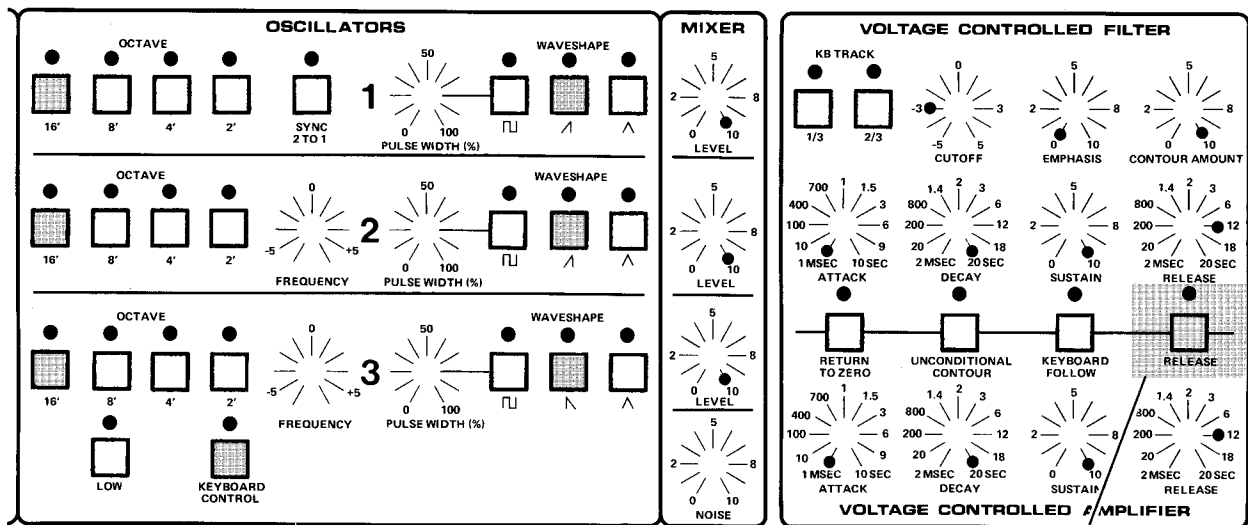

HIT A NOTE. LISTEN TO WHAT HAPPENS WHEN YOU TURN THE RELEASE SWITCH ON AND OFF AS YOU LET UP ON THE KEY.

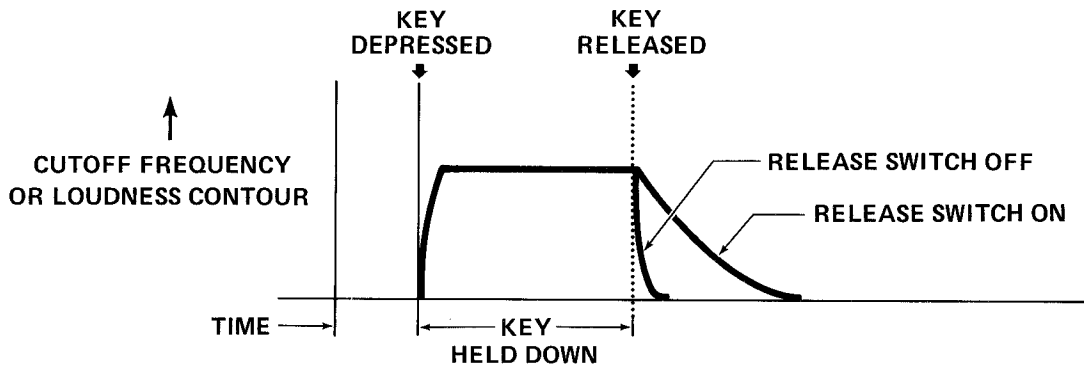

With the two ADSR CONTOUR GENERATORS, it's easy to see that there are many possible combinations of settings. Experiment. At first, try setting both CONTOUR GENERATORS the same way so that the effect of each control is obvious. As you get more familiar with the controls and their effects, try different combinations. Maybe a slow attack on the FILTER and a fast attack on the AMPLIFIER. Maybe a high sustain and release on the FILTER. The possibilities are virtually endless.

Also note that unless you have the CONTOUR AMOUNT control (8.4) turned up, the FILTER's CONTOUR GENERATOR will not control the CUTOFF simply because the CONTOUR AMOUNT control attenuates (limits) the signal from the CONTOUR GENERATOR. When it's set at 0, no control voltage is let through.

### CONTOUR MODE CONTROLS

In between the two sets of ADSR controls are four switches (10.0), one of which is the RELEASE SWITCH (8.9), mentioned above. These switches affect both CONTOUR GENERATORS.

RETURN TO ZERO (10.1) governs the way that the attack time responds when triggers are sent to the same voice repeatedly before the entire ADSR cycle has been completed. With this switch off, striking a note repeatedly (make sure you're in a KEYBOARD MODE [1.7] with MEMORY — KB MODE 2 or 4) will cause the attack time to start from the level it had attained before the new trigger was received. With the switch on, retriggering a voice at any time during the attack stage will reset the voltage to zero and start the contour over from the beginning.

### CONTOUR RETURN TO ZERO

The control panel is divided into three main sections:
 

- OSCILLATORS:** Contains three rows of controls. Each row has four octave buttons (16', 8', 4', 2'), a SYNC 2 TO 1 switch, a PULSE WIDTH (%) knob (0-100), and three waveshape buttons (square, triangle, inverted triangle). The second row also includes a FREQUENCY knob (-5 to +5).
- MIXER:** Contains three LEVEL knobs (0-10) and a NOISE knob (0-10).
- VOLTAGE CONTROLLED FILTER:** Contains a KB TRACK switch (1/3, 2/3), a CUTOFF knob (-3 to 3), an EMPHASIS knob (0-10), and a CONTOUR AMOUNT knob (0-10). Below these are four knobs for ATTACK (1MSEC, 10SEC), DECAY (2MSEC, 20SEC), SUSTAIN (0-10), and RELEASE (2MSEC, 20SEC). At the bottom are four switches: RETURN TO ZERO, UNCONDITIONAL CONTOUR, KEYBOARD FOLLOW, and RELEASE.

PLAY A LOW NOTE REPEATEDLY, ABOUT TWICE A SECOND. TURN THE RETURN TO ZERO SWITCH ON AND OFF TO HEAR THE DIFFERENCE. IT'S SUBTLE — LISTEN CLOSELY. PLAY CHORDS TO GET ANOTHER PERSPECTIVE.

## RETURN TO ZERO OFF

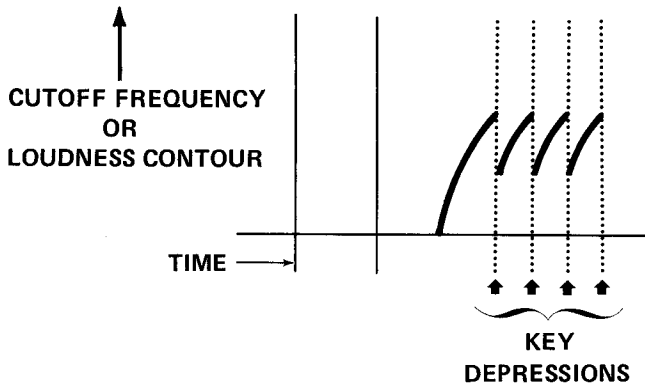

## RETURN TO ZERO ON

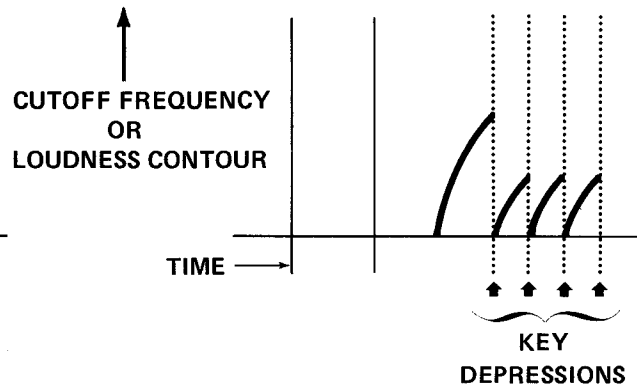

## UNCONDITIONAL CONTOURS

The UNCONDITIONAL CONTOUR switch (10.2) governs the way the attack and release stages of the CONTOUR GENERATORS act. In the CONDITIONAL state (with the switch off), the release stage comes in immediately upon the release of a key, regardless of how far along the contour has gotten. In the UNCONDITIONAL state (with the switch on), if you hit a note, the attack stage will complete itself and then go immediately into the release stage whether you're holding down the note or not. The fact that the attack stage completes itself without your having to hold down the note enables you to set up long attack times, play a note or notes on the keyboard, start playing another keyboard instrument, and have what you played on the Memorymoog fade in and out.

## UNCONDITIONAL CONTOUR

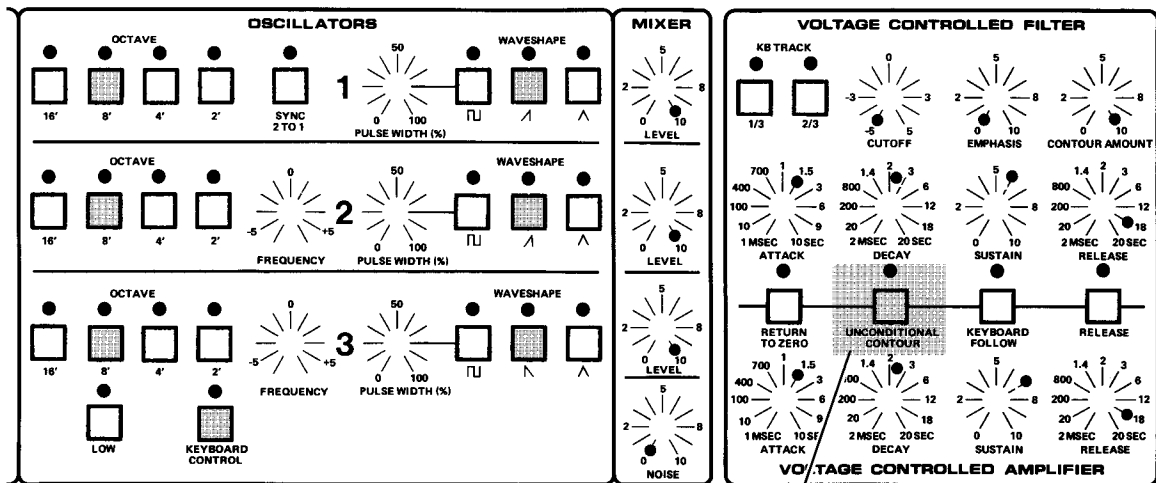

PLAY ONE NOTE QUICKLY WITH THE SWITCH OFF. YOU WON'T HEAR THE NOTE; WITH IT ON, THE NOTE WILL FADE IN.

Set up the CONTOURS like this and play a note on the keyboard quickly. With the UNCONDITIONAL switch off, if you play fast enough, you won't hear the note at all. With the UNCONDITIONAL switch on, the note will fade in even after you've let up on the note.



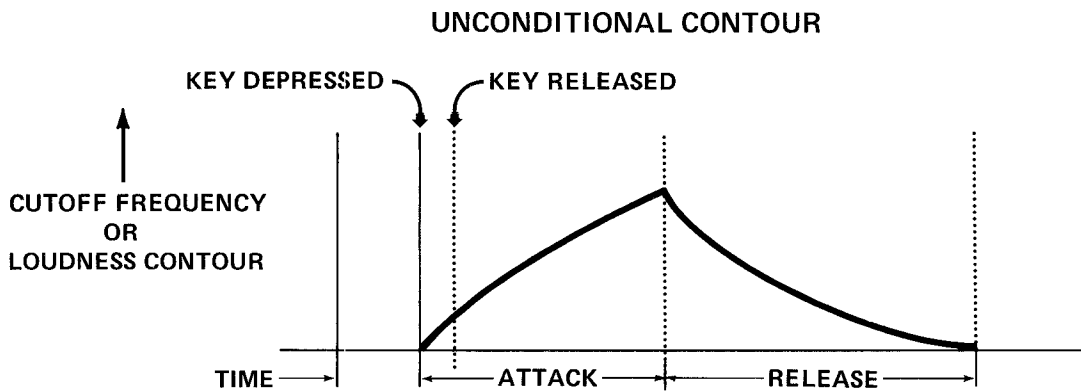
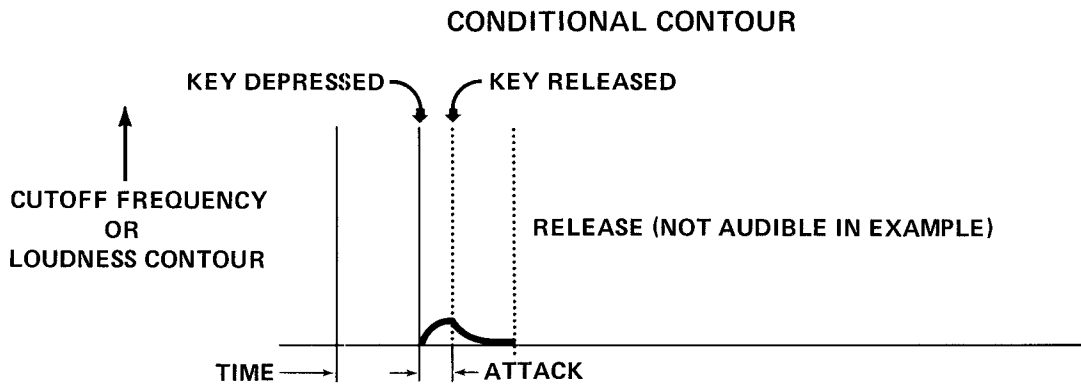

## KEYBOARD FOLLOW

With the CONTOUR GENERATORS set up like this:

### VOLTAGE CONTROLLED FILTER

KB TRACK

 1/3     2/3

0 3 -3

CUTOFF

5 2 8

EMPHASIS

5 2 8

CONTOUR AMOUNT

700 1 1.5 3

400 100 10

1 MSEC 10 SEC

ATTACK

1.4 2 3

800 200 12 18

2 MSEC 20 SEC

DECAY

5 2 8

SUSTAIN

1.4 2 3

800 200 12 18

2 MSEC 20 SEC

RELEASE

RETURN TO ZERO
  UNCONDITIONAL CONTOUR
  **KEYBOARD FOLLOW**
 RELEASE

700 1 1.5 3

400 100 10

1 MSEC 10 SEC

ATTACK

1.4 2 3

800 200 12 18

2 MSEC 20 SEC

DECAY

5 2 8

SUSTAIN

1.4 2 3

800 200 12 18

2 MSEC 20 SEC

RELEASE

### VOLTAGE CONTROLLED AMPLIFIER

## KEYBOARD FOLLOW

TURN SWITCH ON/OFF. PLAY CHROMATIC SCALE, HOLDING NOTES DOWN MOMENTARILY. NOTICE HOW LOW NOTES SUSTAIN LONGER THAN HIGH NOTES WITH THE SWITCH ON.

play a chromatic scale up the keyboard, first with the **KEYBOARD FOLLOW** switch (10.3) off, and then with it on. Hold the notes down a bit. When you have the **KEYBOARD FOLLOW** switch on, notice that the lower notes seem to sustain longer than the higher ones. That's because the **KEYBOARD FOLLOW** switch causes the attack, decay, and release times of the CONTOURS to get proportionally shorter as you play higher on the keyboard. This mimics the sustain properties of acoustic instruments like the piano and guitar in that their higher notes have less sustain than their lower notes.

Experimenting with CONTOUR GENERATOR settings is an important part of learning to create your own sounds with a synthesizer. CONTOURS or ENVELOPES are a major portion of what gives a sound character and individuality. In your experimenting, here are some rules of thumb you should keep in mind:

A CONTOUR must allow sound to pass, otherwise you will not be able to hear anything from your instrument.

If the VOLTAGE-CONTROLLED AMPLIFIER's CONTOUR is set up with decay and sustain settings as short and small as possible, sounds will be very percussive, no matter how the filter is set.

Short decay times coupled with long attack times will make reverse sound effects.

Release settings will be meaningless unless the RELEASE SWITCH (10.4) is on or the RELEASE FOOTSWITCH (15.1) is held down.

Release times will not affect the sound unless the sustain level is set high enough.

The filter will not be affected by its CONTOUR GENERATOR unless the CONTOUR AMOUNT control (8.4) is turned up.

No sound may be heard if the FILTER CUTOFF (8.2) and the CONTOUR AMOUNT (8.4) controls are not up high enough to pass any sound.

Long attack times will give the impression that nothing is happening unless you hold notes long enough, or unless you have the UNCONDITIONAL CONTOUR switch (10.2) on.

The attack phase can be varied using the RETURN TO ZERO switch (10.1).

## OUTPUTS

The MASTER VOLUME control (11.1) affects the overall output level of the Memorymoog. It is a non-programmable control. It should be set as high as possible to ensure a good signal-to-noise ratio. Note that this control sets the limits of PROGRAMMABLE FOOTPEDAL # 1 (4.1) when it's set to control volume.

The PROGRAMMABLE VOLUME control (11.2) is used to adjust the volume levels so that they are evenly matched. You can use this control to balance quiet patches with louder ones so that you don't have to fiddle with the MASTER VOLUME control every time you change a preset.

The HEADPHONE VOLUME control (11.3) is used to vary the output level to a pair of stereo 8Ω headphones, which can be plugged in at the front right of the instrument at the key block.

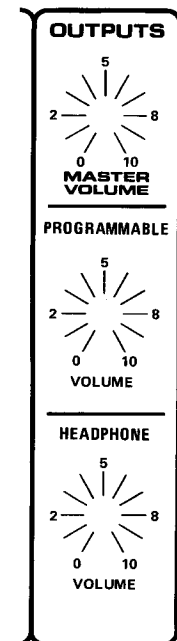
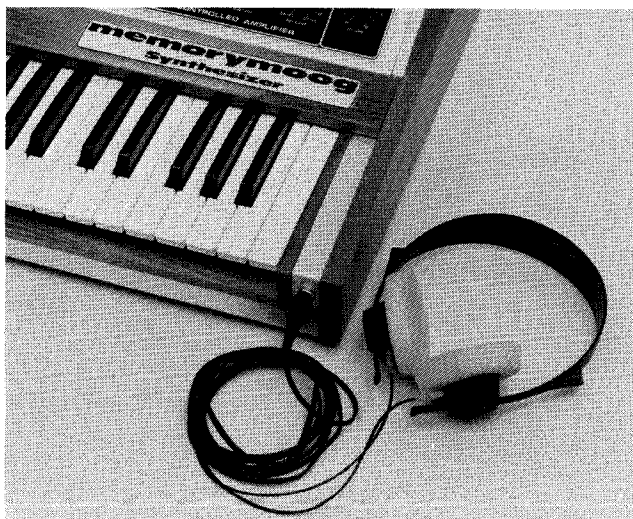

## MODULATION

Modulation is the process of varying a sound source, or a sound modifier, to change the character of the sound. In the Memorymoog, the sound sources are the OSCILLATORS and NOISE SOURCE, and the modifier is the FILTER. There are three sources of modulation: the LFO (low-frequency oscillator), OSCILLATOR 3, and the FILTER CONTOUR GENERATOR.

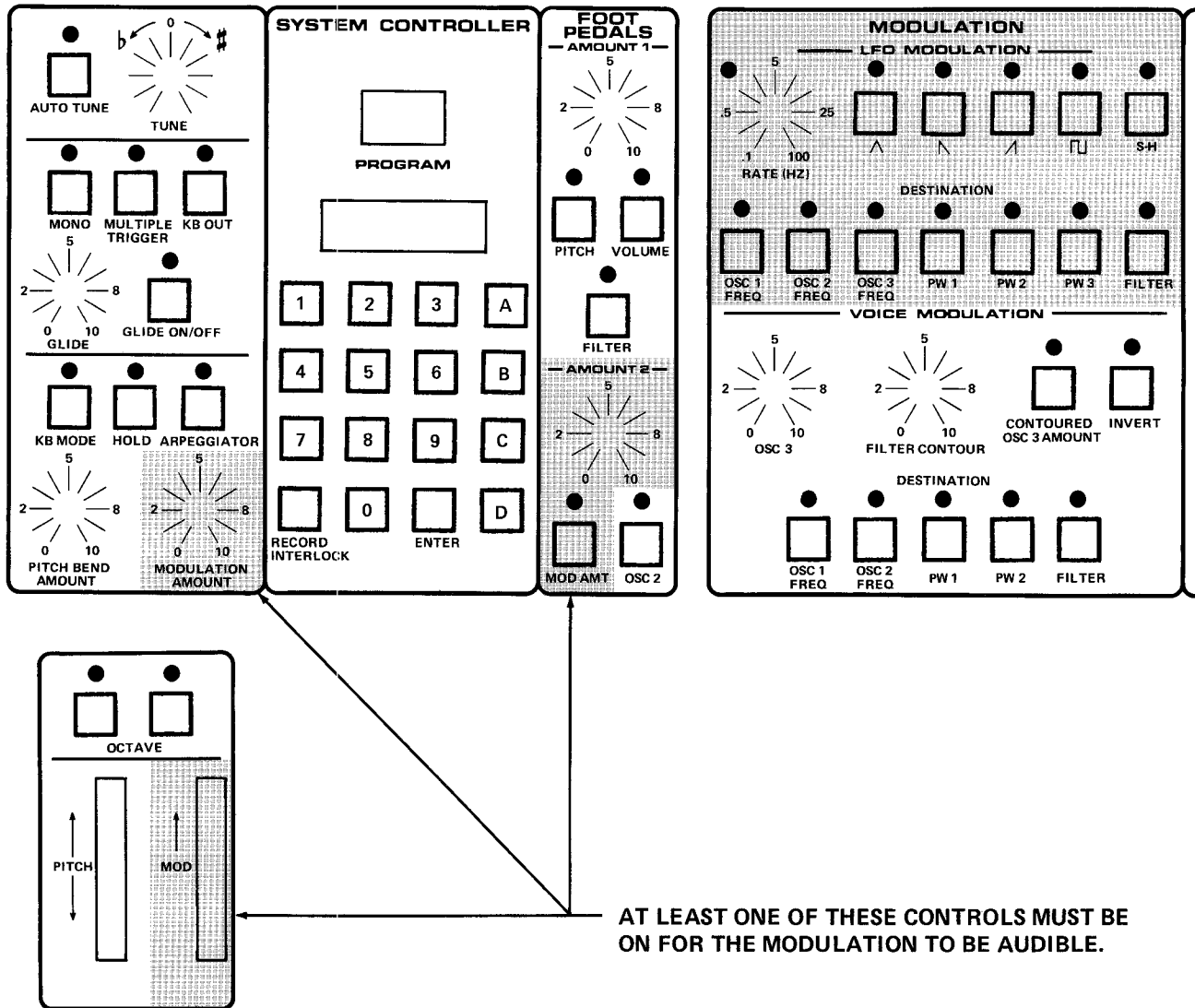

## LFO MODULATION

The low-frequency oscillator (5.0) serves a dual function in the Memorymoog: it is a source of modulation for creating effects like vibrato and filter sweeping, and it is the internal clock for the ARPEGGIATOR (1.9). In its role as a modulation source, it produces triangle  $\wedge$ , positive-going sawtooth  $\nearrow$ , negative-going sawtooth  $\searrow$ , square  $\square$ , and sample and hold (random) waveshapes. When these waveshapes are applied to the oscillators, the filter, and/or the pulse widths of the three oscillators, various useful and interesting effects can be produced.

At least one of the following controls *must* be on for modulation from the LFO to be audible: the MODULATION WHEEL (2.3); the MODULATION AMOUNT control (1.11); and/or the FOOT-PEDAL MOD AMOUNT controls (4.2). If none of these is on, no modulation will be heard.

## LFO MODULATION DESTINATIONS

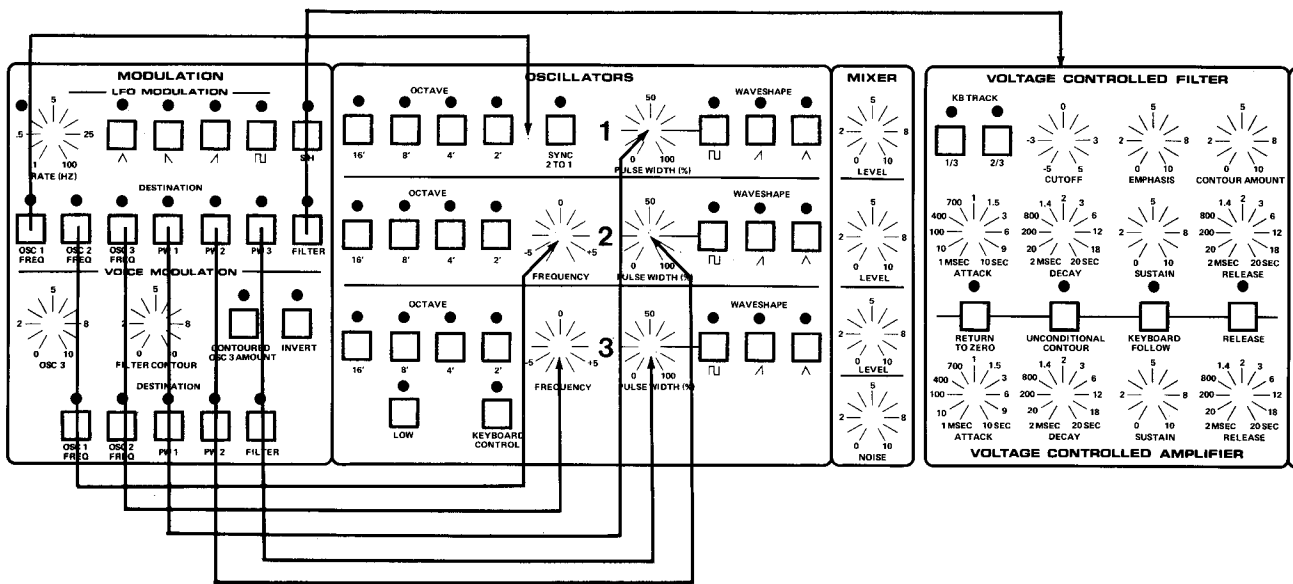

The above diagram shows the possible destinations for the LFO's control voltage. It can be used to sweep the pitch of the oscillators individually, in pairs, or simultaneously. It can sweep the oscillators' pulse widths and/or it can sweep the filter's CUTOFF frequency.

When you modulate the pitch of the oscillators with a triangle wave, you can create vibrato. The LFO RATE control (5.1) adjusts its speed. Try this setting of the LFO, experimenting with controlling first one oscillator, then two, then all three:

## LFO-CREATED VIBRATO

LISTEN TO THE EFFECT THE RATE CONTROL HAS.  
VIBRATO IS CREATED IN THE RANGE OF THE SHADED AREA.

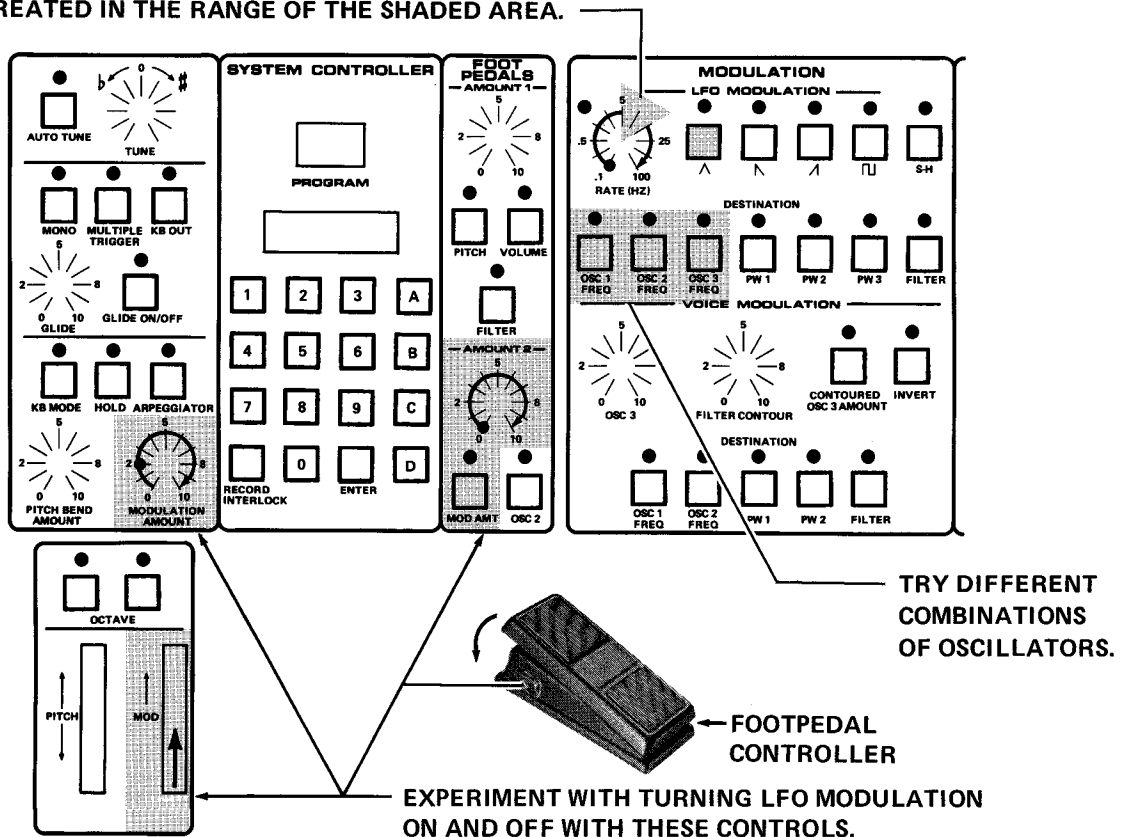

Note what effects the different settings of the various MODULATION AMOUNT controls (2.3, 1.11, and 4.2) have, both on the sound of the modulation effect and on each other. The WHEEL (2.3) adds to the MODULATION AMOUNT controls (1.11 and 4.2), as does the FOOTPEDAL CONTROLLER (13.2).

Listen to the same LFO MODULATION setting with all the different waveshapes – positive- and negative-going sawtooths, square, and S-H (sample and hold random). The sawtooth waves produce glides up or down in pitch; the square wave produces trills which can be tuned by the AMOUNT controls; and the sample and hold produces randomized pitch shifts.

You can get some interesting effects when you use different waveshapes from the LFO to modulate the pulse widths of the three oscillators. When you change the width of a pulse wave, you're changing its harmonic content and therefore its timbre. By slowly sweeping the widths of different combinations of pulse waves you can get phasing-like sounds, string sounds, and so on. The key to this technique is experimentation. Try different LFO speeds, different LFO waveshapes, different pulse widths and different pulse widths at different octaves.

### LFO PW MODULATION

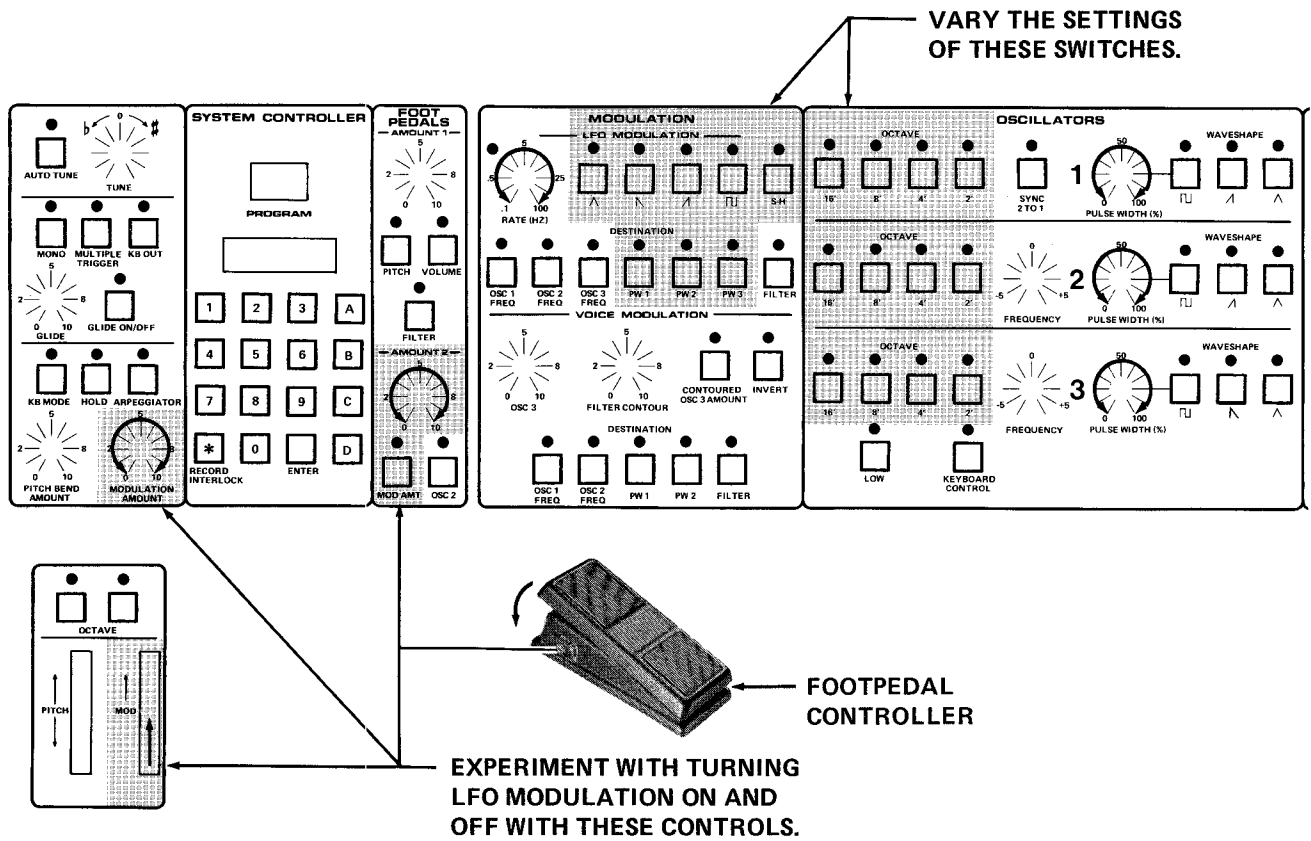

When modulation is applied to the FILTER, it affects the FILTER CUTOFF FREQUENCY (8.2). There are many useful sounds created by FILTER MODULATION. A triangle wave can give you nice slow swells. Sawtooth waves give you reiteration effects. Positive-going sawtooths open the FILTER up (the sound gets brighter as the FILTER opens). Negative-going sawtooths close the FILTER down (the sound gets more muted as the FILTER closes). A square wave will give you a bright/muted sound which alternates as the waveshape goes through its cycle – momentarily high, momentarily low.

Sample and hold will randomly percolate. Again, experiment with different modulation speeds, waveshapes, and different amounts of modulation. Try modulation with a high FILTER EMPHASIS setting. Change the CUTOFF. Remember, it's possible to open the CUTOFF control so far that you won't hear any modulation effect. If you start adding CONTOUR shapes to the FILTER while it's being modulated from the LFO or some other source (such as a voltage pedal), it's possible to drive the CUTOFF frequency so high that you won't hear any modulation. If, in your fiddling around with knobs and dials, you suddenly get no modulation, turn the CUTOFF control counterclockwise. If that doesn't help, make sure you've turned up one of the three possible MODULATION AMOUNT controls (the MODULATION WHEEL [2.3], the MODULATION AMOUNT control [1.11], and/or PROGRAMMABLE FOOTPEDAL # 2 [4.2]).

### LFO FILTER MODULATION

TRY ALL THE DIFFERENT WAVESHAPES.

HIGH EMPHASIS SETTINGS WITH LOW CUTOFF SETTINGS WILL LET YOU HEAR THE DIFFERENT WAVESHAPES FROM THE LFO AS THEY MODULATE THE FILTER.

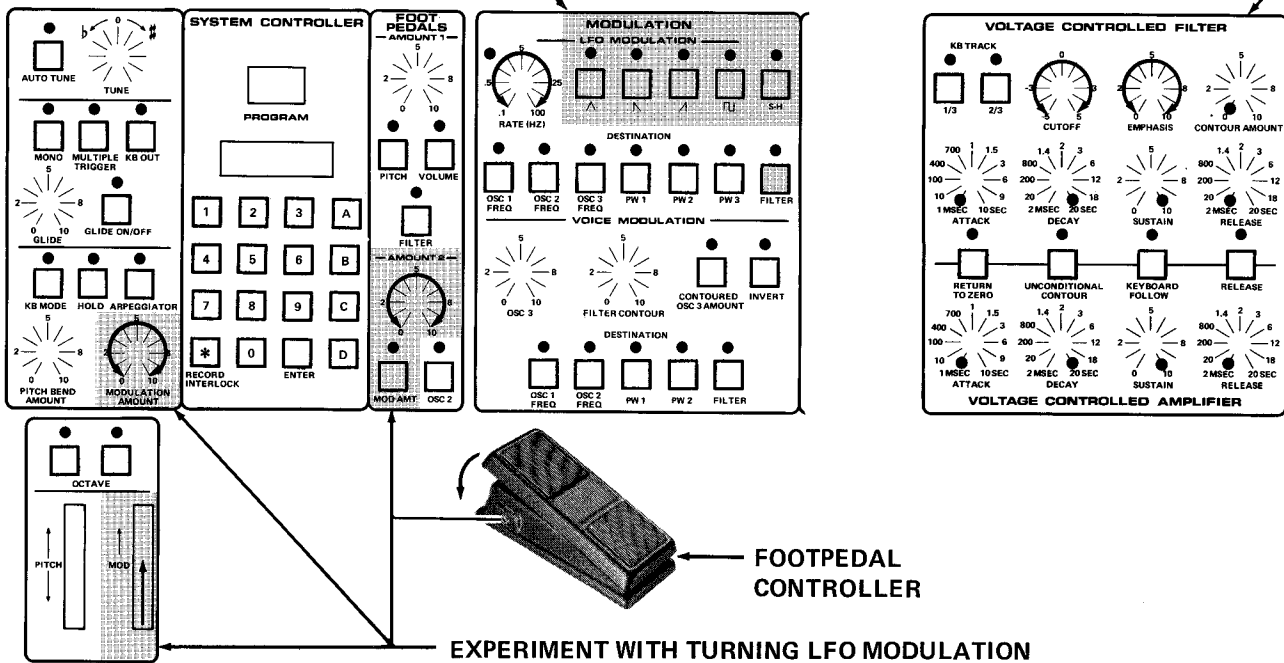

EXPERIMENT WITH TURNING LFO MODULATION ON AND OFF WITH THESE CONTROLS.

Some rules of thumb about modulation:

Triangle waves are used to create vibrato when applied to the oscillators at a rate between about 5 and 20Hz.

Pulse width modulation is useful for creating string sounds, which require a lot of phasing and motion in them. It is also possible to "turn on" and "turn off" an oscillator by modulating its pulse width from or to 0% (only the pulse wave should be on if you're trying to do this).

If the rate is slow enough while modulating an oscillator(s), you can hear the waveshape of the LFO. The faster the rate of modulation, the more clangorous the sound.

When modulating the filter, it's possible to have the CUTOFF frequency so high as to not be able to hear any modulation at all.

Square wave modulation of the oscillators is used to create trills, which can be tuned with the modulation amount controls.

Positive-going sawtooth waves raise the pitch of the oscillators and open the filter's CUTOFF. Negative-going sawtooth waves lower the pitch of the oscillators and close the filter's CUTOFF.

## VOICE MODULATION

The two sources of VOICE MODULATION are the filter's CONTOUR GENERATOR and OSCILLATOR 3. Any function that changes or modulates these two sources will in turn be reflected in the character of voice modulation sent to the various possible destinations.

### VOICE MODULATION SOURCES

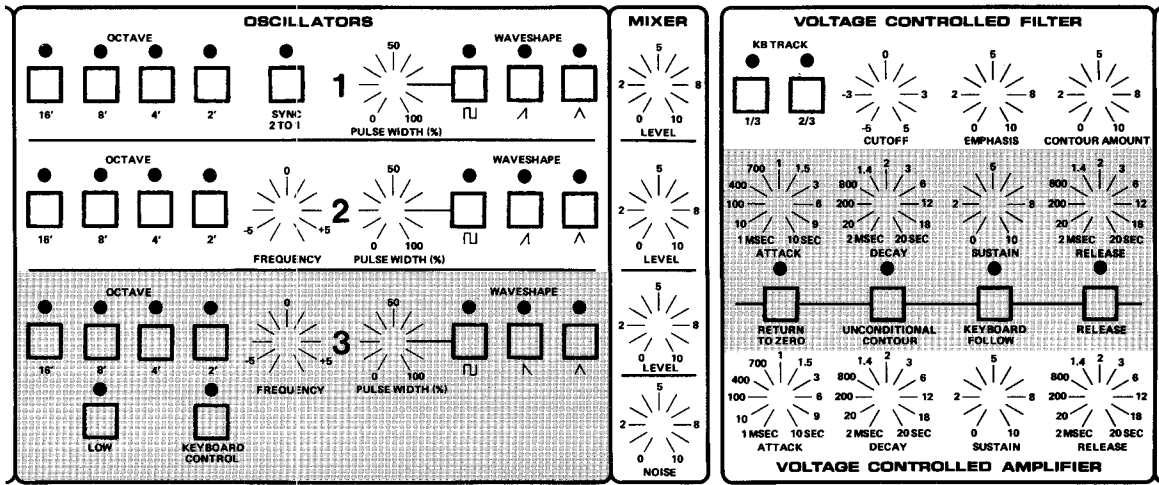

### DESTINATIONS OF THE VOICE MODULATION

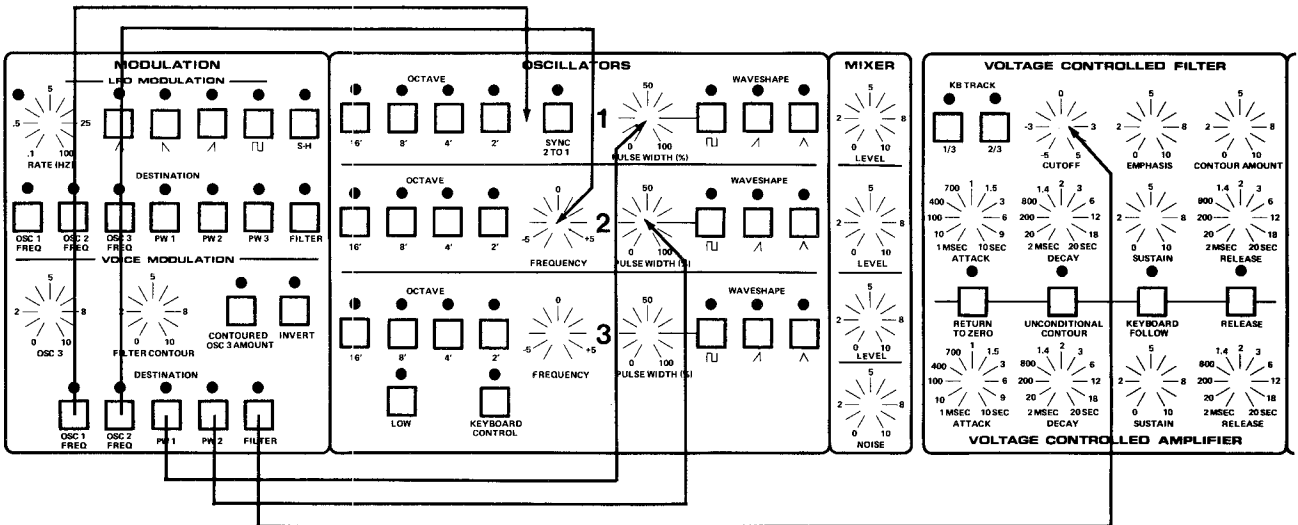

The major distinction between LFO and VOICE MODULATION is that there is only one master LFO, while there is an entirely different situation with VOICE MODULATION. Since there are six filter CONTOUR GENERATORS (one for each of the six voices), every time you trigger one of the six, you get control voltages that vary with time. These voltages can be applied to the frequency and/or the pulse widths of the first two oscillators, and/or to the filter's CUTOFF frequency of that voice. To hear this effect set up the following patch:

## FILTER CONTOUR VOICE MODULATION

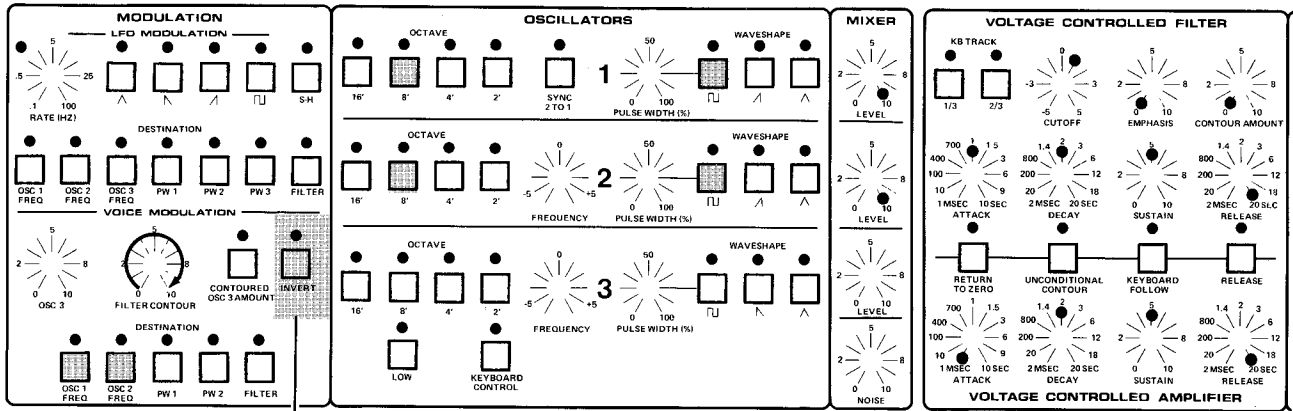

NOTE THE EFFECT OF TURNING ON THE INVERT SWITCH.

Change the destination switches to hear the effect of modulating the different destinations with a contour. Notice that when you play more than one note, each has its own distinct and independent CONTOUR.

Some of the most common SYNC sounds are created by modulating the frequency of OSCILLATOR 2 with the FILTER CONTOUR while OSCILLATOR 2 is SYNCED to OSCILLATOR 1. Experiment with this patch, changing the frequency of OSCILLATOR 2 with its frequency control (6.5), changing its octave setting, adjusting the CONTOUR controls to all sorts of different shapes, trying various CONTOUR MODE switches (10.0) . . .

## VOICE MODULATION SYNC EFFECTS

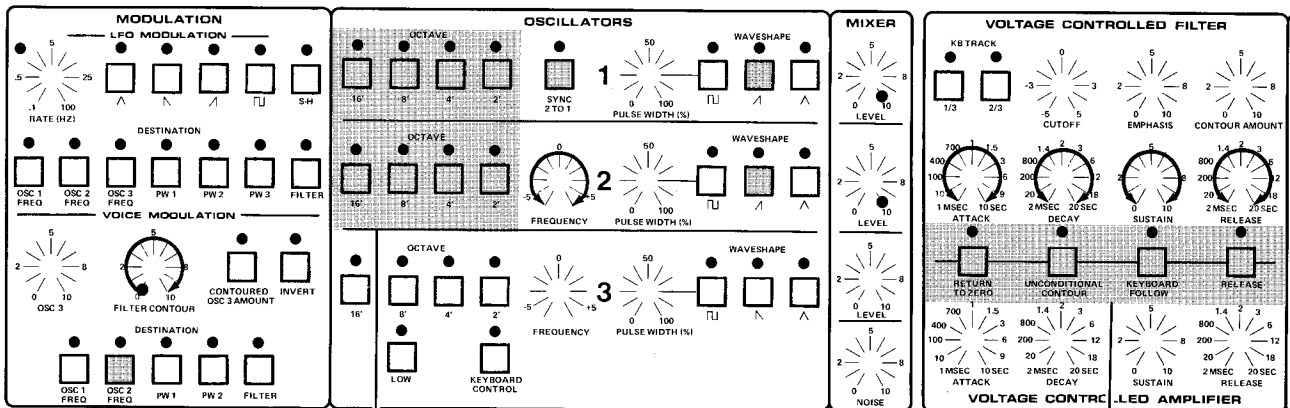

EXPERIMENT WITH VARYING THESE SWITCHES.



You can also invert (turn upside down) the filter CONTOUR's voltage by using the INVERT switch (5.8). Note the effect that using this switch has on the way the CONTOUR affects pitch.

Remember that no VOICE MODULATION will be heard unless one of the two VOICE MODULATION AMOUNT controls (5.5 and 5.6) is turned up and you have at least one DESTINATION switch (5.9) on.

### VOICE MODULATION AMOUNT CONTROLS

**VOICE MODULATION AMOUNT CONTROLS**  
**AT LEAST ONE HAS TO BE ON TO HEAR ANY VOICE MODULATION. ALSO, SOME DESTINATION HAS TO BE SWITCHED IN.**

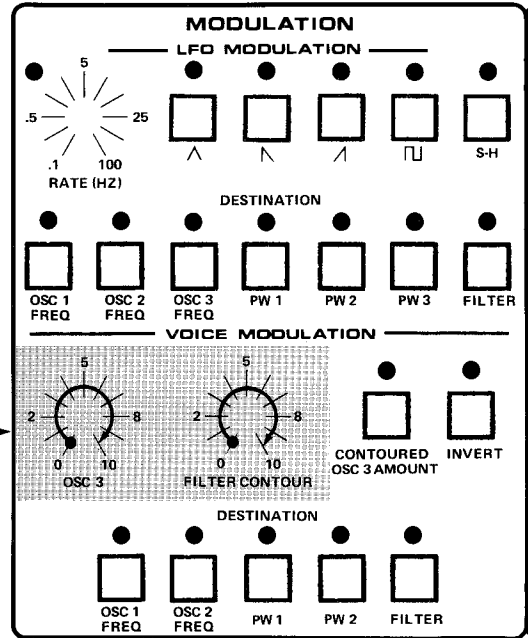

Just as there are six FILTER CONTOUR GENERATORS, there are six OSCILLATOR 3s (one for each voice card). These can be used as voltage sources for the VOICE MODULATION section. OSCILLATOR 3 can operate in both audio and sub-audio ranges (below the threshold of hearing, like an LFO). Keyboard control of OSCILLATOR 3 can be switched in and out. When it's not being controlled by the keyboard, OSCILLATOR 3 acts as a full-range modulation oscillator, a sort of super LFO. Set up this patch and listen to the effects of OSCILLATOR 3 as a modulation oscillator:

### OSCILLATOR 3 AS AN LFO

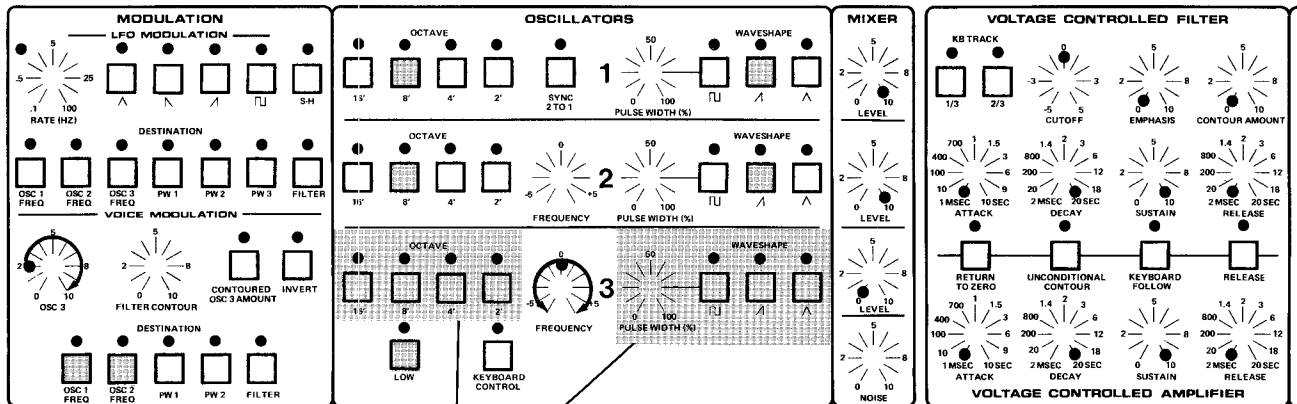

**TRY DIFFERENT OCTAVE SETTINGS, DIFFERENT WAVESHAPES AND COMBINATIONS OF WAVESHAPES.**

The INVERT switch (5.8) will have a very noticeable effect on the sawtooth waveshape from OSCILLATOR 3. Set up this patch:

### INVERTING THE SAWTOOTH WAVESHAVE FROM OSCILLATOR 3

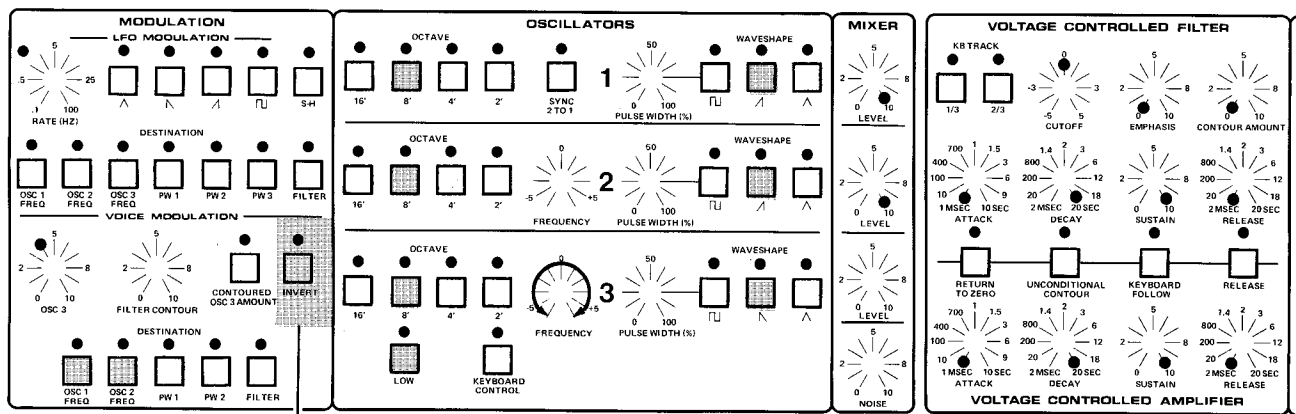

LISTEN TO THE MODULATION WITH THIS SWITCH ON AND WITH IT OFF.

Play a note on the keyboard. Now turn the INVERT switch on and off, listening to the modulation in each case. The INVERT switch inverts the waveshapes so that both positive- and negative-going sawtooths are available from OSCILLATOR 3.

Another thing you can do with the VOICE MODULATION section is use the FILTER'S CONTOUR GENERATOR to control the amount of OSCILLATOR 3 modulation. This lets you vary the amount of OSCILLATOR 3 modulation across time, using the CONTOUR controls. Try this patch to hear the effect:

### CONTOURED OSCILLATOR 3 MODULATION

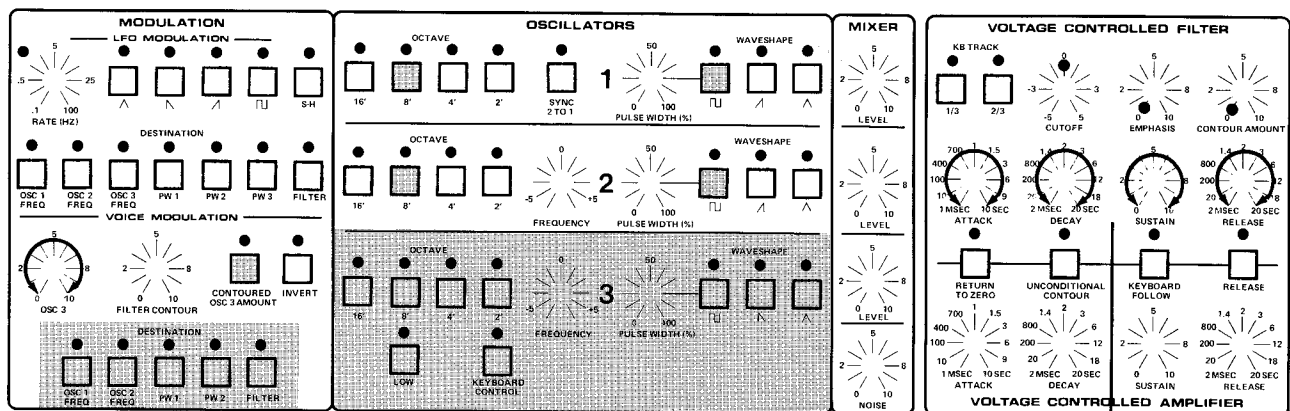

NOTE THE EFFECT OF DIFFERENT CONTOUR SHAPES ON THE AMOUNT OF OSCILLATOR 3 MODULATION.

EXPERIMENT WITH DIFFERENT SETTINGS.

There's no law against using OSCILLATOR 3's KEYBOARD CONTROL function while OSCILLATOR 3 is acting as a modulation oscillator. Using the KEYBOARD CONTROL switch (6.8) while the LOW switch (6.7) is on will give you modulation effects whose speed will vary in relation to where you are playing on the keyboard: high notes produce fast modulation; low notes produce slow modulation. With the LOW switch off, you'll be applying audio frequencies as modulation voltages. This effect is characterized by buzziness and grit.

You should try combining both OSCILLATOR 3 and the FILTER CONTOUR as VOICE MODULATION sources. Experiment in every way you can think of to familiarize yourself with your instrument. When you run out of ideas, just turn knobs and dials until you come across a sound you like. Then retrace how it's being created and store the knowledge in the back of your mind for future reference. The best way to get to know an instrument like the Memorymoog is to use it.

Some rules of thumb about VOICE MODULATION:

At least one of the two VOICE MODULATION AMOUNT controls (5.5 and 5.6) has to be turned up to hear any modulation effect.

At least one of the five DESTINATION switches (5.9) has to be on to hear any modulation.

The INVERT switch turns the FILTER CONTOUR and OSCILLATOR 3 waveshapes upside down.

In order for the pulse width modulation to function, the oscillators have to be putting out pulse waves.

If the CUTOFF of the FILTER is up too high you won't hear any FILTER modulation.

If you have too much control voltage going to the FILTER, you will drive the CUTOFF frequency so high that you won't hear modulation anymore.

Positive-going sawtooths cause the pitch of an oscillator to rise and the CUTOFF of the FILTER to open. Negative-going sawtooths cause the pitch of an oscillator to fall and the CUTOFF of the FILTER to close.

Pulse waves can be used for creating trills. These can be tuned by using the OSCILLATOR 3 MODULATION AMOUNT control (5.5). Varying the pulse width will vary the time between the up and down portions of the trill.

Pulse waves can be used to open and close the FILTER in an on/off, up/down manner.

Triangle waves can be used to create vibrato when applied to an oscillator. They can also create repetitive swells when applied to the FILTER, and phase shift when applied to pulse widths.

Audio frequency modulation, used subtly, can give timbres more bite.

Using the FILTER CONTOUR to sweep the frequency of OSCILLATOR 2 when it's SYNCED to the frequency of OSCILLATOR 1 creates the strong dynamic timbral sounds that are often associated with the SYNC effect.

## THE PROGRAMMABLE FOOTPEDALS

These are fairly self-explanatory. PEDAL 1 can be used to control the frequencies of the oscillators for pitch bending. The range of the bend effect can be tuned by using the rotary AMOUNT control. Volume and the CUTOFF frequency of the filter can be controlled in the same way. Note that when you're using the pedal to control the volume of the instrument, the extreme limit (the loudest the instrument can get) is set by the MASTER VOLUME control (11.1).

PEDAL 2 can be used as an LFO MODULATION AMOUNT control, just like the MODULATION WHEEL (2.3), and it can be used to control the pitch of OSCILLATOR 2. When used to adjust the LFO MODULATION AMOUNT, the pedal adds to the initial amount of modulation set up by the MODULATION AMOUNT control (1.11). In both functions — controlling the amount of modulation and sweeping the pitch of OSCILLATOR 2 — the AMOUNT control adjusts the range of the pedal.

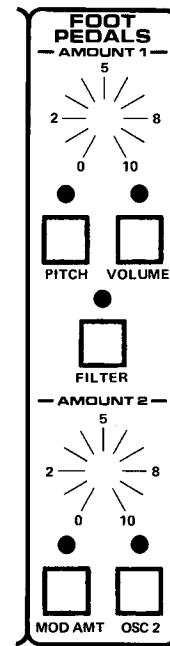

Pedals aren't supplied with the instrument. They should be voltage pedals with a range of 0 to 5 volts, such as the Moog 1120 pedals. Your local music shop should have, or be able to order, suitable pedals. Note that if you have just one pedal, the inputs on the back of the Memorymoog are crosscoupled, meaning that if you plug in just one pedal, it will do the work of two. For example: a pedal is plugged into the PEDAL 1 input, but all the programs you've called up show that PEDAL 2 will control the modulation. PEDAL 1 will crosscouple so that it will control the modulation amount because there isn't a pedal connected to the PEDAL 2 jack.

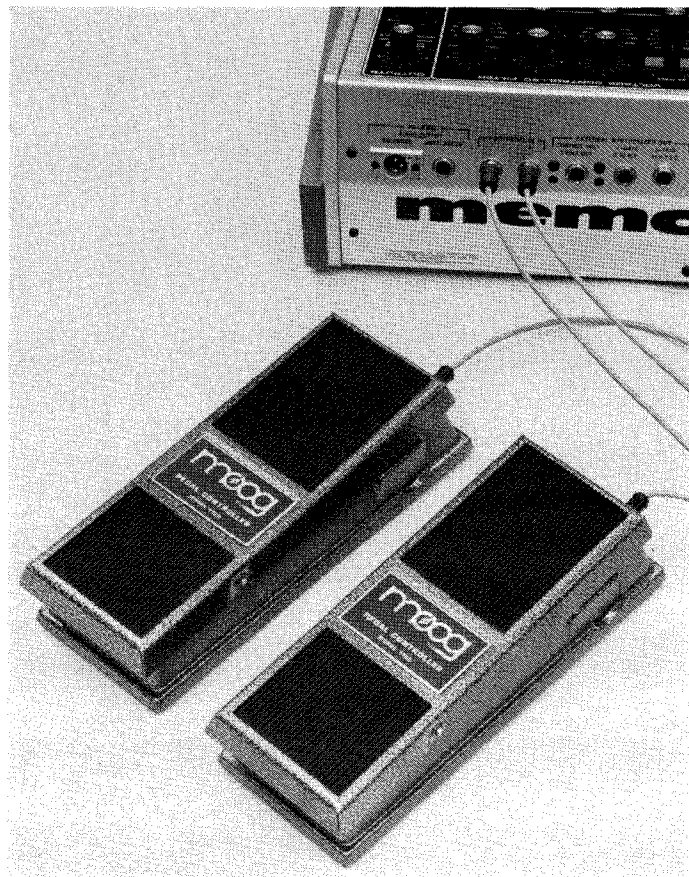

## MEMORYMOOG SOUND CHARTS

The following page shows the Memorymoog programs listed by title and category. Units shipped from the factory have the 10 program chains built with the 10 categories listed.

Factory programs for the Memorymoog were supplied by:

Don Airey	Lee Hargrove
John Bezjian	Nancy Kewin
Jeff Burger	Roger Luther
Todd Booth	Dominic Milano
Wendy Carlos	Val Podlasinski
Tom Coster	Bob Wehrman
Herbert Deutsch	Rock Wehrmann
Larry Fast	Bill Wolfer
Jan Hammer	

We would like to thank the countless people whose comments, suggestions and musical creativity have contributed to the making of the Memorymoog.

For purposes of quick identification, the voices have been grouped in a rough decimal order as follows:

SYNTH	STRINGS	BRASS	SYNTH	ORGAN/MONO
0 Synth Sweep w/ Glide	1 String 1	2 Brass 1	3 Vocal Chorus	4 Organ 1
10 Octave Trill	11 String 2	12 Brass 2	13 Tuned Percussion	14 Organ 2 (Pipes)
20 Sync Sample & Hold	21 String 3	22 Brass 3	23 Octave Synth	24 Organ 3
30 Poly Glide	31 String 4	32 Brass 4	33 Sizzle	34 Calliope
40 Synth Sweep 1	41 String 5	42 Brass 5	43 Sync 4	44 Organ 5
50 Wind Chimes	51 String 6	52 Brass 6	53 Double Reed	54 Mono 1
60 FM 1	61 String 7	62 Brass 7	63 Synth Organ	64 Mono 2
70 Bowed Octaves	71 String 8	72 Brass 8	73 Release Voice	74 Mono 3
80 Synth Woodwinds	81 String 9	82 Brass 9	83 Surprise	84 Mono 4
90 Quint Synth	91 String 10	92 Brass 10	93 Triangle Waves	94 Mono 5

EFFECTS	SYNTH	KB	SYNTH	KB
5 Filter Trill	6 Synth (Sq. Waves 1)	7 Electric Piano 1	8 Sync 1	9 Harp
15 Bells	16 Recorder	17 Power Synth	18 Sync 2	19 Steel Drums
25 Take-Off	26 Butterflies in Space	27 Clav 1	28 Sync 3	29 Clav 2
35 Log Drum	36 Flutes	37 Clav Wah	38 Unconditional Contour	39 Vibes
45 Sirens	46 Synth Sweep 2	47 Celeste	48 Sync Sweep 3	49 Harpsichord 1
55 UFO	56 Chorus Synth	57 Clav 3	58 Echo Whistle	59 Electric Piano 2
65 Synth Sweep 4	66 Square Waves 2	67 Quint Harpsichord	68 Wind Chimes 2	69 Electric Piano 3
75 Quint Filter Trill	76 Quint Oscillator Trill	77 Accordion	78 Synth Plectrum	79 Sync 5
85 Drop Off	86 Ring Mod	87 Harpsichord 2	88 Repeat Voice	89 Clav 4
95 Ring Mod 2	96 Dupe No. 75	97 Octave Synth 2	98 Synth Plectrum 2	99 Clav 5

A conscious effort has been made to keep similar voices from being next to each other.

**SYSTEM CONTROLLER**

PROGRAM

1 2 3 4 5 6 7 8 9 0

RECORD INTERLOCK

ENTER

**FOOT PEDALS**

AMOUNT 1

100

PITCH VOLUME

FILTER

AMOUNTS 2

0

MOD.AMT OSC 2

**MODULATION**

LFQ MODULATION

DIRECTION

OSC 1 OSC 2 OSC 3

PW 1 PW 2 PW 3

FILTER

VOICE MODULATION

OSC 1 OSC 2 OSC 3

PW 1 PW 2 PW 3

FILTER

**OSCILLATORS**

OCTAVE

16' 8' 4' 2'

WAVESHAPES

1 50

SYNC 2 TO 1

PULSE WIDTH (N)

FREQUENCY

0 48 3

KEYBOARD CONTROL

LOW

**VOLTAGE CONTROLLED FILTER**

RETRACK

0

EMPHASIS

52

CONTOUR AMOUNT

95

UNCONDITIONAL FOLLOW

UNCONDITIONAL CONTOUR

UNCONDITIONAL DECAY

UNCONDITIONAL RELEASE

**VOLTAGE CONTROLLED AMPLIFIER**

RETURN TO ZERO

UNCONDITIONAL FOLLOW

UNCONDITIONAL CONTOUR

UNCONDITIONAL DECAY

UNCONDITIONAL RELEASE

**MIXER**

LEVEL

100

NOISE

0

**OUTPUTS**

PROGRAMMABLE

100

VOLUME

HEADPHONE

VOLUME

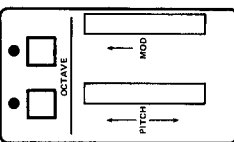

### 0. SYNTH (SWEEP WITH GLIDE)

KB MODE 1 (cyclic) ensures that each new chord played will glide from somewhere else. Pedal 1 is programmed at 100; it can be used to control volume.

**SYSTEM CONTROLLER**

PROGRAM

1 2 3 4 5 6 7 8 9 0

RECORD INTERLOCK

ENTER

**FOOT PEDALS**

AMOUNT 1

100

PITCH VOLUME

FILTER

AMOUNTS 2

0

MOD.AMT OSC 2

**MODULATION**

LFQ MODULATION

DIRECTION

OSC 1 OSC 2 OSC 3

PW 1 PW 2 PW 3

FILTER

VOICE MODULATION

OSC 1 OSC 2 OSC 3

PW 1 PW 2 PW 3

FILTER

**OSCILLATORS**

OCTAVE

16' 8' 4' 2'

WAVESHAPES

1 51

SYNC 2 TO 1

PULSE WIDTH (N)

FREQUENCY

0 48 2

KEYBOARD CONTROL

LOW

**VOLTAGE CONTROLLED FILTER**

RETRACK

0

EMPHASIS

18

CONTOUR AMOUNT

0

UNCONDITIONAL FOLLOW

UNCONDITIONAL CONTOUR

UNCONDITIONAL DECAY

UNCONDITIONAL RELEASE

**VOLTAGE CONTROLLED AMPLIFIER**

RETURN TO ZERO

UNCONDITIONAL FOLLOW

UNCONDITIONAL CONTOUR

UNCONDITIONAL DECAY

UNCONDITIONAL RELEASE

**MIXER**

LEVEL

26

NOISE

0

**OUTPUTS**

PROGRAMMABLE

100

VOLUME

HEADPHONE

VOLUME

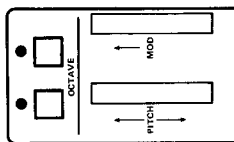

### 1. STRING 1

Advance the Modulation Wheel about halfway for broader vibrato effects. Pedal 1 can be used to control volume.

## 2. BRASS 1

The Keyboard Follow function makes higher notes "snappier" than low notes.  
Turn on MOD AMT in the Pedal section for foot control of vibrato.

## 3. VOCAL CHORUS

The high Emphasis setting produces a characteristic vocal resonance. Note: The character of this voice changes dramatically when the left-hand Octave controls are changed. Pedal 1 can control loudness.



**SYSTEM CONTROLLER**

PROGRAM

1 2 3 4 5 6 7 8 9 0 ENTER

RECORD INTERLOCK

**FOOT PEDALS**

AMOUNT 1

100

PITCH

VOLUME

FILTER

AMOUNT 2

0

MOD AMT OSC 2

**MODULATION**

LED MODULATION

RATE (HZ)

38

OSC 1 FREQ

OSC 2 FREQ

OSC 3 FREQ

DESTINATION

PW 1 PW 2 PW 3

VOICE MODULATION

OSC 1 FREQ

OSC 2 FREQ

OSC 3 FREQ

DESTINATION

CONToured OSC 3 AMOUNT

INVERT

FILTER

PW 1 PW 2 FILTER

**OSCILLATORS**

OCTAVE

16' 8' 4' 2'

WAVESHAPES

PULSE WIDTH (NS)

1 48

FREQUENCY

2 48

3 49

KEYBOARD CONTROL

LOW

**MIXER**

52

LEVEL

44

LEVEL

100

LEVEL

0

NOISE

**VOLTAGE CONTROLLED FILTER**

KB TRACK

1/3 2/3

CUTOFF

31

EMPHASIS

28

CONTOUR AMOUNT

14

ATTACK

0

1MS/SEC 10SEC 2MS/SEC 20SEC

RELEASE

0

2MS/SEC 20SEC

UNCONDITIONAL CONTOUR FOLLOW

KEYBOARD FOLLOW

RELEASE

0

1MS/SEC 10SEC 2MS/SEC 20SEC

RELEASE

0

2MS/SEC 20SEC

**OUTPUTS**

PROGRAMMABLE

100

VOLUME

HEADPHONE

0 10

VOLUME

#### 4. ORGAN 1

OCTAVE

PITCH

MOD

A high Level plus multiple waveshape outputs on Oscillator 3 add a little "dirt" to this sound. Pedal 1 can control loudness.

**SYSTEM CONTROLLER**

PROGRAM

1 2 3 4 5 6 7 8 9 0 ENTER

RECORD INTERLOCK

**FOOT PEDALS**

AMOUNT 1

0

PITCH

VOLUME

FILTER

AMOUNT 2

0

MOD AMT OSC 2

**MODULATION**

LED MODULATION

RATE (HZ)

0

OSC 1 FREQ

OSC 2 FREQ

OSC 3 FREQ

DESTINATION

PW 1 PW 2 PW 3

VOICE MODULATION

OSC 1 FREQ

OSC 2 FREQ

OSC 3 FREQ

DESTINATION

CONToured OSC 3 AMOUNT

INVERT

FILTER

PW 1 PW 2 FILTER

**OSCILLATORS**

OCTAVE

16' 8' 4' 2'

WAVESHAPES

PULSE WIDTH (NS)

1 50

FREQUENCY

2 48

3 55

KEYBOARD CONTROL

LOW

**MIXER**

100

LEVEL

100

LEVEL

100

LEVEL

0

NOISE

**VOLTAGE CONTROLLED FILTER**

KB TRACK

1/3 2/3

CUTOFF

18

EMPHASIS

83

CONTOUR AMOUNT

60

ATTACK

100

1MS/SEC 10SEC 2MS/SEC 20SEC

RELEASE

0

2MS/SEC 20SEC

UNCONDITIONAL CONTOUR FOLLOW

KEYBOARD FOLLOW

RELEASE

0

1MS/SEC 10SEC 2MS/SEC 20SEC

RELEASE

0

2MS/SEC 20SEC

**OUTPUTS**

PROGRAMMABLE

50

VOLUME

HEADPHONE

0 10

VOLUME

#### 5. FX 1

OCTAVE

PITCH

MOD

A contoured Osc 3 amount controls the Filter. Since Osc 3 is under keyboard control, the rate of the effect changes as a function of keyboard location.

**SYSTEM CONTROLLER**

PROGRAM

1 2 3 4 5 6 7 8 9 0 ENTER

INTERLOCK

**PEDALS**

AMOUNT 1

0 2 4 6 8 10

PITCH

VOLUME

0 2 4 6 8 10

MOD.AMT. OSC.2

**MODULATION**

OSC.1 FREQ. OSC.2 FREQ. OSC.3 FREQ.

OSC.1 RATE (HZ) OSC.2 RATE (HZ) OSC.3 RATE (HZ)

DESTINATION

OSC.1 PW1 OSC.2 PW2 OSC.3 PW3

OSC.1 FILTER OSC.2 FILTER OSC.3 FILTER

OSC.1 INVERT OSC.2 INVERT OSC.3 INVERT

OSC.1 AMOUNT OSC.2 AMOUNT OSC.3 AMOUNT

**OSCILLATORS**

OCTAVE

18' 8' 4' 2' 1' 0' 1' 2' 3' 4' 5' 6' 7' 8' 9' 10' 11' 12' 13' 14' 15' 16'

WAVESHARE

50

PULSE WIDTH (NS)

0 100

FREQUENCY

0 5 10 15 20 25 30 35 40 45 50

SYNC 2 TO 1

**MIXER**

LEVEL

0 2 4 6 8 10

NOISE

0 2 4 6 8 10

**VOLTAGE CONTROLLED FILTER**

RETRACK

0 2 4 6 8 10

CUTOFF

0 2 4 6 8 10

EMPHASIS

0 2 4 6 8 10

CONTOUR AMOUNT

0 2 4 6 8 10

UNCONDITIONAL CONTOUR

0 2 4 6 8 10

ATTACK

0 2 4 6 8 10

DECAY

0 2 4 6 8 10

2MS/SEC 2MS/SEC 2MS/SEC 2MS/SEC

RELEASE

0 2 4 6 8 10

KEYBOARD FOLLOW

0 2 4 6 8 10

UNCONDITIONAL CONTOUR

0 2 4 6 8 10

ATTACK

0 2 4 6 8 10

DECAY

0 2 4 6 8 10

2MS/SEC 2MS/SEC 2MS/SEC 2MS/SEC

RELEASE

0 2 4 6 8 10

KEYBOARD FOLLOW

0 2 4 6 8 10

**OUTPUTS**

PROGRAMMABLE

0 2 4 6 8 10

MASTER VOLUME

0 2 4 6 8 10

HEADPHONE VOLUME

0 2 4 6 8 10

### 6. SYNTH (SQUARE WAVES)

With the Filter attack and decay times at zero, each note has a "click" at the beginning. Pedal 2 can control modulation amount.

**SYSTEM CONTROLLER**

PROGRAM

1 2 3 4 5 6 7 8 9 0 ENTER

INTERLOCK

**PEDALS**

AMOUNT 1

0 2 4 6 8 10

PITCH

VOLUME

0 2 4 6 8 10

MOD.AMT. OSC.2

**MODULATION**

OSC.1 FREQ. OSC.2 FREQ. OSC.3 FREQ.

OSC.1 RATE (HZ) OSC.2 RATE (HZ) OSC.3 RATE (HZ)

DESTINATION

OSC.1 PW1 OSC.2 PW2 OSC.3 PW3

OSC.1 FILTER OSC.2 FILTER OSC.3 FILTER

OSC.1 INVERT OSC.2 INVERT OSC.3 INVERT

OSC.1 AMOUNT OSC.2 AMOUNT OSC.3 AMOUNT

**OSCILLATORS**

OCTAVE

18' 8' 4' 2' 1' 0' 1' 2' 3' 4' 5' 6' 7' 8' 9' 10' 11' 12' 13' 14' 15' 16'

WAVESHARE

50

PULSE WIDTH (NS)

0 100

FREQUENCY

0 5 10 15 20 25 30 35 40 45 50

SYNC 2 TO 1

**MIXER**

LEVEL

0 2 4 6 8 10

NOISE

0 2 4 6 8 10

**VOLTAGE CONTROLLED FILTER**

RETRACK

0 2 4 6 8 10

CUTOFF

0 2 4 6 8 10

EMPHASIS

0 2 4 6 8 10

CONTOUR AMOUNT

0 2 4 6 8 10

UNCONDITIONAL CONTOUR

0 2 4 6 8 10

ATTACK

0 2 4 6 8 10

DECAY

0 2 4 6 8 10

2MS/SEC 2MS/SEC 2MS/SEC 2MS/SEC

RELEASE

0 2 4 6 8 10

KEYBOARD FOLLOW

0 2 4 6 8 10

UNCONDITIONAL CONTOUR

0 2 4 6 8 10

ATTACK

0 2 4 6 8 10

DECAY

0 2 4 6 8 10

2MS/SEC 2MS/SEC 2MS/SEC 2MS/SEC

RELEASE

0 2 4 6 8 10

KEYBOARD FOLLOW

0 2 4 6 8 10

**OUTPUTS**

PROGRAMMABLE

0 2 4 6 8 10

MASTER VOLUME

0 2 4 6 8 10

HEADPHONE VOLUME

0 2 4 6 8 10

### 7. ELECTRIC PIANO 1

The overtone that creates the "tines" sound is produced by Osc 3. Pedal 1 can control volume.

**SYSTEM CONTROLLER**

PROGRAM

1 2 3 4 5 6 7 8 9 0

RECORD INTERLOCK ENTER

**PEALS**

AMOUNT 1

0

PITCH VOLUME

MOD AMT OSC 2

**MODULATION**

LED MODULATION

RATE (HZ)

OSC 1 FREQ OSC 2 FREQ OSC 3 FREQ

DESTINATION

PW1 PW2 PW3

VOICE MODULATION

OSC 1 FREQ OSC 2 FREQ OSC 3 FREQ

DESTINATION

PW1 PW2 FILTER

**OSCILLATORS**

OCTAVE

16' 8' 4' 2'

WAVESHAPE

PULSE WIDTH (NS)

1 51

FREQUENCY

2 76

3 51

KEYBOARD CONTROL

LOW

**MIXER**

92

100

85

0

NOISE

**VOLTAGE CONTROLLED FILTER**

KB TRACK

1/3 2/3

EMPHASIS

0 15

CUTOFF

3 0

CONTOUR AMOUNT

5 55

PROGRAMMABLE

56

VOLUME

HEADPHONE

2 5 8

**VOLTAGE CONTROLLED AMPLIFIER**

RETURN TO ZERO

700 1 1.5 3 800 200 400

1 MSEC 10 SEC 2 MSEC 20 SEC

ATTACK DECAY

0 20

UNCONDITIONAL FOLLOW

1.4 2 3

0 27

DECAY

2 54

SUSTAIN

RELEASE

96

KEYBOARD FOLLOW

1.4 2 3

0 0

DECAY

2 56

SUSTAIN

RELEASE

76

OUTPUTS

5

2 5 8

VOLUME

HEADPHONE

2 5 8

VOLUME

### 8. SYNTH (SYNC 1)

OCTAVE

PITCH MOD

Any attempt to change the frequency of Osc 2 produces the "sync" effect. The Program routes the Filter Contour to Osc 2; manual changes can be made with Pedal 2.

**SYSTEM CONTROLLER**

PROGRAM

1 2 3 4 5 6 7 8 9 0

RECORD INTERLOCK ENTER

**PEALS**

AMOUNT 1

0

PITCH VOLUME

MOD AMT OSC 2

**MODULATION**

LED MODULATION

RATE (HZ)

OSC 1 FREQ OSC 2 FREQ OSC 3 FREQ

DESTINATION

PW1 PW2 PW3

VOICE MODULATION

OSC 1 FREQ OSC 2 FREQ OSC 3 FREQ

DESTINATION

PW1 PW2 FILTER

**OSCILLATORS**

OCTAVE

16' 8' 4' 2'

WAVESHAPE

PULSE WIDTH (NS)

1 7

FREQUENCY

2 48

3 48

KEYBOARD CONTROL

LOW

**MIXER**

21

20

17

0

NOISE

**VOLTAGE CONTROLLED FILTER**

KB TRACK

1/3 2/3

EMPHASIS

0 42

CUTOFF

3 0

CONTOUR AMOUNT

5 68

PROGRAMMABLE

100

VOLUME

HEADPHONE

2 5 8

**VOLTAGE CONTROLLED AMPLIFIER**

RETURN TO ZERO

700 1 1.5 3 800 200 400

1 MSEC 10 SEC 2 MSEC 20 SEC

ATTACK DECAY

0 0

UNCONDITIONAL FOLLOW

1.4 2 3

0 48

DECAY

2 50

SUSTAIN

RELEASE

76

KEYBOARD FOLLOW

1.4 2 3

0 0

DECAY

2 56

SUSTAIN

RELEASE

76

OUTPUTS

5

2 5 8

VOLUME

HEADPHONE

2 5 8

VOLUME

### 9. HARP

OCTAVE

PITCH MOD

Narrow pulse waves produce the plucked-string effect. A characteristic playing style is arpeggiated or rolled chords.

10. SYNTH (OCTAVE TRILL) The LFO modulates all six voices at the same rate. If the trill is not exactly an octave, adjust the Modulation Amount

11. STRING 2 Setting the VCA attack time slower than the Filter produces a "bowing" effect. Pedal 1 can control volume.

**SYSTEM CONTROLLER**

PROGRAM

RECORD INTERLOCK

ENTER

1 2 3 4 5 6 7 8 9 0

**FOOT PEDALS**

MOD AMT OSC 2

MOD AMT OSC 1

**MODULATION**

OSC 1 FREQ OSC 2 FREQ OSC 3 FREQ

OSC 1 MOD OSC 2 MOD OSC 3 MOD

OSC 1 DEST OSC 2 DEST OSC 3 DEST

OSC 1 FILTER OSC 2 FILTER OSC 3 FILTER

OSC 1 INVERT OSC 2 INVERT OSC 3 INVERT

OSC 1 AMOUNT OSC 2 AMOUNT OSC 3 AMOUNT

OSC 1 ON OSC 2 ON OSC 3 ON

OSC 1 OFF OSC 2 OFF OSC 3 OFF

**OSCILLATORS**

1 50

2 48

3 50

**MIXER**

100

100

100

0

**VOLTAGE CONTROLLED FILTER**

23

12

26

55

71

96

32

44

48

**OUTPUTS**

MASTER VOLUME

48

HEADPHONE VOLUME

48

### 12. BRASS 2

For a chorus brass sound, turn on the sawtooth waveshape for Osc 2 and/or Osc 3.  
Pedal 1 can control filter cutoff (brightness).

OCTAVE

PITCH

MOD

**SYSTEM CONTROLLER**

PROGRAM

RECORD INTERLOCK

ENTER

1 2 3 4 5 6 7 8 9 0

**FOOT PEDALS**

MOD AMT OSC 2

MOD AMT OSC 1

**MODULATION**

OSC 1 FREQ OSC 2 FREQ OSC 3 FREQ

OSC 1 MOD OSC 2 MOD OSC 3 MOD

OSC 1 DEST OSC 2 DEST OSC 3 DEST

OSC 1 FILTER OSC 2 FILTER OSC 3 FILTER

OSC 1 INVERT OSC 2 INVERT OSC 3 INVERT

OSC 1 AMOUNT OSC 2 AMOUNT OSC 3 AMOUNT

OSC 1 ON OSC 2 ON OSC 3 ON

OSC 1 OFF OSC 2 OFF OSC 3 OFF

**OSCILLATORS**

1 50

2 88

3 61

3 35

**MIXER**

56

27

28

0

**VOLTAGE CONTROLLED FILTER**

0

12

35

52

100

21

63

80

63

**OUTPUTS**

MASTER VOLUME

48

HEADPHONE VOLUME

48

### 13. FX (PERCUSSION)

“Tapping” a key and releasing it immediately lets the percussive effect ring longer;  
holding a key down damps the effect.

OCTAVE

PITCH

MOD

14. ORGAN 2 (PIPES)

The key to this voice is pitching the oscillators at different octaves to simulate the different ranks of a pipe organ.

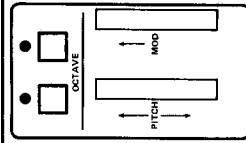

15. BELLS

Pitches produced by this voice intentionally do not match the key played. Pedal 1 can control volume.

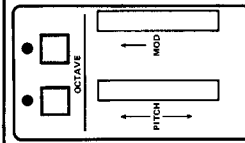



18. SYNC 2

This voice produces an octave overtone effect on sustained tones. Pedal 2 can produce additional sync effects.

19. STEEL DRUMS

The key to this voice is the detuning of Osc 3. It can be tweaked in or out of tune to fit individual taste.





**SYSTEM CONTROLLER**

PROGRAM

1 2 3 4 5 6 7 8 9 0

RECORD INTERLOCK ENTER

**FOOT PEDALS**

AMOUNT 1

PITCH VOLUME

0 10

MOD.AMT. OSC.2

**MODULATION**

LFO MODULATION

RATE (HZ)

5 100 25

OSC.1 FREQ. OSC.2 FREQ. OSC.3 FREQ.

DESTINATION

PH1 PH2 PH3

VOICE MODULATION

OSC.1 FREQ. OSC.2 FREQ. OSC.3 FREQ.

DESTINATION

CONT. AMT. OSC.2 AMOUNT

OSC.1 FREQ. OSC.2 FREQ. OSC.3 FREQ.

**OSCILLATORS**

OCTAVE

16' 8' 4' 2'

WAVESHAPE

PULSE WIDTH (NS)

50 100

FREQUENCY

0 5 10 15 20

KEYBOARD CONTROL

LOW

**MIXER**

38 40 37 0

LEVEL

0 5 10

NOISE

**VOLTAGE CONTROLLED FILTER**

KB TRACK

1/3 2/3

RETURN TO ZERO

700 1.5 3 6 100 200 400

1MSEC. TO 5SEC. 2MSEC. TO 20SEC.

ATTACK DECAY

0 10 20 30

CUTOFF

69 45 53

EMPHASIS

0 1 2 3 4 5

CONT. AMT. OSC.2

0 10 20 30

RELEASE

1.4 2 3 4 5

UNCONDITIONAL FOLLOW ON

700 1.5 3 6 100 200 400

1MSEC. TO 5SEC. 2MSEC. TO 20SEC.

ATTACK DECAY

0 10 20 30

CUTOFF

27 54 96

EMPHASIS

0 1 2 3 4 5

CONT. AMT. OSC.2

0 10 20 30

RELEASE

1.4 2 3 4 5

**OUTPUTS**

PROGRAMMABLE

100

VOLUME

0 10 20 30

HEADPHONE

5

VOLUME

0 10 20 30

The Sample and Hold voltage is sent to the synced Osc 2. Try this voice with Glide and with additional sync effects from Pedal 2.

20. SYNC SAMPLE AND HOLD

OCTAVE

PITCH

MOD

**SYSTEM CONTROLLER**

PROGRAM

1 2 3 4 5 6 7 8 9 0

RECORD INTERLOCK ENTER

**FOOT PEDALS**

AMOUNT 1

PITCH VOLUME

0 10

MOD.AMT. OSC.2

**MODULATION**

LFO MODULATION

RATE (HZ)

5 100 25

OSC.1 FREQ. OSC.2 FREQ. OSC.3 FREQ.

DESTINATION

PH1 PH2 PH3

VOICE MODULATION

OSC.1 FREQ. OSC.2 FREQ. OSC.3 FREQ.

DESTINATION

CONT. AMT. OSC.2 AMOUNT

OSC.1 FREQ. OSC.2 FREQ. OSC.3 FREQ.

**OSCILLATORS**

OCTAVE

16' 8' 4' 2'

WAVESHAPE

PULSE WIDTH (NS)

50 100

FREQUENCY

0 5 10 15 20

KEYBOARD CONTROL

LOW

**MIXER**

26 30 0 0

LEVEL

0 5 10

NOISE

**VOLTAGE CONTROLLED FILTER**

KB TRACK

1/3 2/3

RETURN TO ZERO

700 1.5 3 6 100 200 400

1MSEC. TO 5SEC. 2MSEC. TO 20SEC.

ATTACK DECAY

0 10 20 30

CUTOFF

33 18 0

EMPHASIS

0 1 2 3 4 5

CONT. AMT. OSC.2

0 10 20 30

RELEASE

1.4 2 3 4 5

UNCONDITIONAL FOLLOW ON

700 1.5 3 6 100 200 400

1MSEC. TO 5SEC. 2MSEC. TO 20SEC.

ATTACK DECAY

0 10 20 30

CUTOFF

41 32 44

EMPHASIS

0 1 2 3 4 5

CONT. AMT. OSC.2

0 10 20 30

RELEASE

1.4 2 3 4 5

**OUTPUTS**

PROGRAMMABLE

100

VOLUME

0 10 20 30

HEADPHONE

5

VOLUME

0 10 20 30

21. STRING 3

OCTAVE

PITCH

MOD

Long attack times and heavy modulation make this voice useful for chord background work. For more vibrato, advance the MOD WHEEL to about 1/2.

**22. BRASS 3**

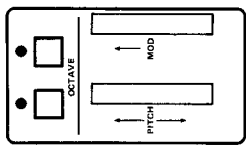

The "brassiness" of this voice is generated in the voice modulation section. Pedal 2 can control vibrato.

**23. OCTAVE SYNTH**

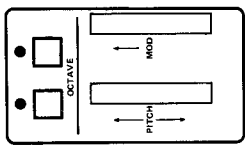

Try this voice with and without Glide. Pedal 1 can control Filter Cutoff (brightness).

**SYSTEM CONTROLLER**

PROGRAM: [ ]

1 2 3 4 5 6 7 8 9 0

ENTER

INTERLOCK

**PEALS**

AMOUNT 1: 100

PITCH VOLUME

AMOUNT 2: 0

MOD AMT OSC 2

**MODULATION**

LEG MODULATION: [ ]

DESTINATION: [ ]

RATE (Hz): 65

OSC 1 FREQ: [ ]

OSC 2 FREQ: [ ]

OSC 3 FREQ: [ ]

VOICE MODULATION: [ ]

OSC 1 FREQ: [ ]

OSC 2 FREQ: [ ]

OSC 3 FREQ: [ ]

CONToured OSC 3 AMOUNT: [ ]

OSC 1 FREQ: [ ]

OSC 2 FREQ: [ ]

OSC 3 FREQ: [ ]

**OSCILLATORS**

OCTAVE: [ ]

WAVESHAPe: [ ]

PULSE WIDTH (Hz): 55

FREQUENCY: 49

KEYBOARD CONTROL: [ ]

OCTAVE: [ ]

WAVESHAPe: [ ]

PULSE WIDTH (Hz): 50

FREQUENCY: 88

KEYBOARD CONTROL: [ ]

OCTAVE: [ ]

WAVESHAPe: [ ]

PULSE WIDTH (Hz): 60

FREQUENCY: [ ]

KEYBOARD CONTROL: [ ]

**MIXER**

LEVEL: 100

LEVEL: 100

LEVEL: 82

NOISE: 0

**VOLTAGE CONTROLLED FILTER**

KB TRACK: [ ]

CUTOFF: 37

EMPHASIS: 54

CONTOUR AMOUNT: 17

ATTACK: 0

DECAY: 16

RELEASE: 82

UNCONDITIONAL FOLLOW ON: [ ]

KEYBOARD FOLLOW ON: [ ]

UNCONDITIONAL FOLLOW OFF: [ ]

KEYBOARD FOLLOW OFF: [ ]

ATTACK: 0

DECAY: 100

RELEASE: 0

**VOLTAGE CONTROLLED AMPLIFIER**

ATTACK: 0

DECAY: 100

RELEASE: 0

**OUTPUTS**

PROGRAMMABLE VOLUME: 36

HEADPHONE VOLUME: [ ]

### 24. ORGAN 3

For more animation to the sound, move the MOD WHEEL up to about 1/2. Pedal 1 can control volume.

OCTAVE

PITCH

MOD

**SYSTEM CONTROLLER**

PROGRAM: [ ]

1 2 3 4 5 6 7 8 9 0

ENTER

INTERLOCK

**PEALS**

AMOUNT 1: 0

PITCH VOLUME

AMOUNT 2: 0

MOD AMT OSC 2

**MODULATION**

LEG MODULATION: [ ]

DESTINATION: [ ]

RATE (Hz): 64

OSC 1 FREQ: [ ]

OSC 2 FREQ: [ ]

OSC 3 FREQ: [ ]

VOICE MODULATION: [ ]

OSC 1 FREQ: [ ]

OSC 2 FREQ: [ ]

OSC 3 FREQ: [ ]

CONToured OSC 3 AMOUNT: 61

OSC 1 FREQ: [ ]

OSC 2 FREQ: [ ]

OSC 3 FREQ: [ ]

**OSCILLATORS**

OCTAVE: [ ]

WAVESHAPe: [ ]

PULSE WIDTH (Hz): 50

FREQUENCY: 71

KEYBOARD CONTROL: [ ]

OCTAVE: [ ]

WAVESHAPe: [ ]

PULSE WIDTH (Hz): 50

FREQUENCY: 14

KEYBOARD CONTROL: [ ]

OCTAVE: [ ]

WAVESHAPe: [ ]

PULSE WIDTH (Hz): 81

FREQUENCY: [ ]

KEYBOARD CONTROL: [ ]

**MIXER**

LEVEL: 25

LEVEL: 100

LEVEL: 70

NOISE: 100

**VOLTAGE CONTROLLED FILTER**

KB TRACK: [ ]

CUTOFF: 51

EMPHASIS: 100

CONTOUR AMOUNT: 67

ATTACK: 31

DECAY: 100

RELEASE: 100

UNCONDITIONAL FOLLOW ON: [ ]

KEYBOARD FOLLOW ON: [ ]

UNCONDITIONAL FOLLOW OFF: [ ]

KEYBOARD FOLLOW OFF: [ ]

ATTACK: 0

DECAY: 100

RELEASE: 54

**VOLTAGE CONTROLLED AMPLIFIER**

ATTACK: 0

DECAY: 100

RELEASE: 0

**OUTPUTS**

PROGRAMMABLE VOLUME: 48

HEADPHONE VOLUME: [ ]

### 25. TAKE-OFF

The amount of pitch rise is determined by how long a key is held down. Try turning on different destinations in the LFO Modulation section.

OCTAVE

PITCH

MOD

The Filter "flutter" rates will be slightly different for each voice.  
 For a more unified effect, turn up the MOD WHEEL.

26. BUTTERFLIES IN SPACE

27. CLAV 1

For a chorus clay sound, turn on the pulse waveshapes for Osc 2 or Osc 3.  
 Pedal 1 can control brightness; the Mod Wheel brings in vibrato.

**SYSTEM CONTROLLER**

PROGRAM

RECORD INTERLOCK

ENTER

1 2 3 4 5 6 7 8 9 0

A B C D

**PEAKS**

AMOUNT 1

PITCH

VOLUME

FILTER

AMOUNT 2

MOD AMT OSC 2

**OSCILLATORS**

WAVESHARE

PULSE WIDTH (IN)

50

1 50 2 50 3 50

SYNC 2 TO 1

FREQUENCY

OCTAVE

16' 8' 4' 2'

16' 8' 4' 2'

16' 8' 4' 2'

LOW

KEYBOARD CONTROL

**MODULATION**

LFO MODULATION

RATE (HZ)

1 100 5 20

OSC 1 FREQ OSC 2 FREQ OSC 3 FREQ

DESTINATION

PW 1 PW 2 PW 3

FILTER

CONTROLED OSC AMOUNT

INVERT

**VOLTAGE CONTROLLED FILTER**

RETRACK

CUTOFF

0 3 5 7 9 10

EMPHASIS

0 2 4 6 8 10

CONTOUR AMOUNT

0 2 4 6 8 10

94

UNCONDITIONAL FOLLOW

KEYBOARD RELEASE

54

UNCONDITIONAL FOLLOW

KEYBOARD RELEASE

50

UNCONDITIONAL FOLLOW

KEYBOARD RELEASE

58

UNCONDITIONAL FOLLOW

KEYBOARD RELEASE

36

UNCONDITIONAL FOLLOW

KEYBOARD RELEASE

75

UNCONDITIONAL FOLLOW

KEYBOARD RELEASE

68

UNCONDITIONAL FOLLOW

KEYBOARD RELEASE

34

UNCONDITIONAL FOLLOW

KEYBOARD RELEASE

**OUTPUTS**

PROGRAMMABLE

MASTER VOLUME

0 2 4 6 8 10

HEADPHONE VOLUME

0 2 4 6 8 10

Pedal 2 can control additional sync effects; the Mod Wheel will introduce vibrato.

28. SYNC 3

OCTAVE

PITCH

MOD

**SYSTEM CONTROLLER**

PROGRAM

RECORD INTERLOCK

ENTER

1 2 3 4 5 6 7 8 9 0

A B C D

**PEAKS**

AMOUNT 1

PITCH

VOLUME

FILTER

AMOUNT 2

MOD AMT OSC 2

**OSCILLATORS**

WAVESHARE

PULSE WIDTH (IN)

50

1 92 2 92 3 50

SYNC 2 TO 1

FREQUENCY

OCTAVE

16' 8' 4' 2'

16' 8' 4' 2'

16' 8' 4' 2'

LOW

KEYBOARD CONTROL

**MODULATION**

LFO MODULATION

RATE (HZ)

1 100 5 20

OSC 1 FREQ OSC 2 FREQ OSC 3 FREQ

DESTINATION

PW 1 PW 2 PW 3

FILTER

CONTROLED OSC AMOUNT

INVERT

**VOLTAGE CONTROLLED FILTER**

RETRACK

CUTOFF

0 3 5 7 9 10

EMPHASIS

0 2 4 6 8 10

CONTOUR AMOUNT

0 2 4 6 8 10

21

UNCONDITIONAL FOLLOW

KEYBOARD RELEASE

64

UNCONDITIONAL FOLLOW

KEYBOARD RELEASE

0

UNCONDITIONAL FOLLOW

KEYBOARD RELEASE

68

UNCONDITIONAL FOLLOW

KEYBOARD RELEASE

0

UNCONDITIONAL FOLLOW

KEYBOARD RELEASE

36

UNCONDITIONAL FOLLOW

KEYBOARD RELEASE

75

UNCONDITIONAL FOLLOW

KEYBOARD RELEASE

80

UNCONDITIONAL FOLLOW

KEYBOARD RELEASE

**OUTPUTS**

PROGRAMMABLE

MASTER VOLUME

0 2 4 6 8 10

HEADPHONE VOLUME

0 2 4 6 8 10

Pedal 2 can control additional sync effects; the Mod Wheel will introduce vibrato.

29. CLAV 2

OCTAVE

PITCH

MOD

### 30. POLY GLIDE

Modulation can be introduced from the Mod Wheel and/or Pedal. Note that Osc 1 is not modulated. With small amounts of modulation, this produces a chorus effect.

### 31. STRING 4

This is a synth string voice; try it with and without Glide, and with varying amounts of modulation.



**SYSTEM CONTROLLER**

PROGRAM

1 2 3 4 5 6 7 8 9 0 ENTER

RECORD INTERLOCK

**FOOT PEDALS**

AMOUNT 1-5

PITCH VOLUME

FILTER

MOD.AMT OSC 2

**MODULATION**

LD MODULATION

RATE (HZ)

OSC 1 FREQ OSC 2 FREQ OSC 3 FREQ

DESTINATION

OSC 1 OSC 2 OSC 3

VOICE MODULATION

OSC 1 FREQ OSC 2 FREQ OSC 3 FREQ

DESTINATION

OSC 1 OSC 2 OSC 3

FILTER CONTOUR OSC 3 AMOUNT

CONToured INVERT

OSC 1 FREQ OSC 2 FREQ OSC 3 FREQ

DESTINATION

OSC 1 OSC 2 OSC 3

VOICE MODULATION

OSC 1 FREQ OSC 2 FREQ OSC 3 FREQ

DESTINATION

OSC 1 OSC 2 OSC 3

FILTER CONTOUR OSC 3 AMOUNT

CONToured INVERT

OSC 1 FREQ OSC 2 FREQ OSC 3 FREQ

DESTINATION

OSC 1 OSC 2 OSC 3

**OSCILLATORS**

OCTAVE

WAVESHARE

PULSE WIDTH (IN)

FREQUENCY

KEYBOARD CONTROL

**MIXER**

LEVEL

NOISE

**VOLTAGE CONTROLLED FILTER**

KB TRACK

CUTOFF

EMPHASIS

CONTOUR AMOUNT

RELEASE

ATTACK

UNCONDITIONAL CONTOUR

KEYBOARD FOLLOW

RELEASE

**OUTPUTS**

MASTER VOLUME

PROGRAMMABLE

VOLUME

HEADPHONE

VOLUME

34. CALLIOPE

For a slightly brighter sound, turn on any of the waveshapes for Osc 3.

OCTAVE

PITCH MOD

**SYSTEM CONTROLLER**

PROGRAM

1 2 3 4 5 6 7 8 9 0 ENTER

RECORD INTERLOCK

**FOOT PEDALS**

AMOUNT 1-5

PITCH VOLUME

FILTER

MOD.AMT OSC 2

**MODULATION**

LFO MODULATION

RATE (HZ)

OSC 1 FREQ OSC 2 FREQ OSC 3 FREQ

DESTINATION

OSC 1 OSC 2 OSC 3

VOICE MODULATION

OSC 1 FREQ OSC 2 FREQ OSC 3 FREQ

DESTINATION

OSC 1 OSC 2 OSC 3

FILTER CONTOUR OSC 3 AMOUNT

CONToured INVERT

OSC 1 FREQ OSC 2 FREQ OSC 3 FREQ

DESTINATION

OSC 1 OSC 2 OSC 3

**OSCILLATORS**

OCTAVE

WAVESHARE

PULSE WIDTH (IN)

FREQUENCY

KEYBOARD CONTROL

**MIXER**

LEVEL

NOISE

**VOLTAGE CONTROLLED FILTER**

KB TRACK

CUTOFF

EMPHASIS

CONTOUR AMOUNT

RELEASE

ATTACK

UNCONDITIONAL CONTOUR

KEYBOARD FOLLOW

RELEASE

**OUTPUTS**

MASTER VOLUME

PROGRAMMABLE

VOLUME

HEADPHONE

VOLUME

35. LOG DRUM

Try this voice with the Arpeggiator turned on; experiment with different LFO rates.

OCTAVE

PITCH MOD



**SYSTEM CONTROLLER**

PROGRAM

1 2 3 4 5 6 7 8 9 0 ENTER

RECORD INTERLOCK

**FOOT PEDALS**

AMOUNT 1

0 8 10

PITCH VOLUME

FILTER

AMOUNT 2

0 8 10

MOD AMT OSC 2

**MODULATION**

LFO MODULATION

RATE (HZ)

0 25 50 75 100

OSC 1 FREQ OSC 2 FREQ OSC 3 FREQ

DESTINATION

PW 1 PW 2 PW 3

FILTER

VOICE MODULATION

OSC 1 FREQ OSC 2 FREQ OSC 3 FREQ

DESTINATION

CONToured OSC 3 AMOUNT

INVERT

**OSCILLATORS**

1 50

2 50

3 50

WAVESHARE

PULSE WIDTH (NS)

0 50 100

FREQUENCY

0 100

KEYBOARD CONTROL

LOW

**MIXER**

100

42

42

10

LEVEL

0 10

NOISE

**VOLTAGE CONTROLLED FILTER**

KB TRACK

0 5

26

17

42

54

23

42

68

EMPHASIS

0 10

CUTOFF

0 10

UNCONDITIONAL CONTOUR

0 10

KEYBOARD FOLLOW

0 10

RELEASE

0 10

ATTACK

0 10

RELEASE

**OUTPUTS**

MASTER VOLUME

0 10

100

PROGRAMMABLE

VOLUME

0 10

HEADPHONE

VOLUME

0 10

### 36. FLUTES

For a chorus flute sound, turn on the sawtooth waveshapes for Osc 2 or Osc 3. The small amount of noise simulates the air moving through the flute. Modulation is available from the Mod Wheel and/or Pedal 2.

OCTAVE

PITCH

MOD

**SYSTEM CONTROLLER**

PROGRAM

1 2 3 4 5 6 7 8 9 0 ENTER

RECORD INTERLOCK

**FOOT PEDALS**

AMOUNT 1

0 8 10

PITCH VOLUME

FILTER

AMOUNT 2

0 8 10

MOD AMT OSC 2

**MODULATION**

LFO MODULATION

RATE (HZ)

0 25 50 75 100

OSC 1 FREQ OSC 2 FREQ OSC 3 FREQ

DESTINATION

PW 1 PW 2 PW 3

FILTER

VOICE MODULATION

OSC 1 FREQ OSC 2 FREQ OSC 3 FREQ

DESTINATION

CONToured OSC 3 AMOUNT

INVERT

**OSCILLATORS**

1 92

2 70

3 37

50

50

50

WAVESHARE

PULSE WIDTH (NS)

0 50 100

FREQUENCY

0 100

KEYBOARD CONTROL

LOW

**MIXER**

100

100

100

0

0

LEVEL

0 10

NOISE

**VOLTAGE CONTROLLED FILTER**

KB TRACK

0 5

72

36

62

34

62

0

68

EMPHASIS

0 10

CUTOFF

0 10

UNCONDITIONAL CONTOUR

0 10

KEYBOARD FOLLOW

0 10

RELEASE

0 10

ATTACK

0 10

RELEASE

**OUTPUTS**

MASTER VOLUME

0 10

100

PROGRAMMABLE

VOLUME

0 10

HEADPHONE

VOLUME

0 10

### 37. CLAV WAH

Vibrato is available at the Mod Wheel; Pedal 2 will control sync effects.

OCTAVE

PITCH

MOD

**38. UNCONDITIONAL CONTOUR**

SYSTEM CONTROLLER: RECORD INTERLOCK, PROGRAM, ENTER, 1-9, 0, A, B, C, D.

FOOTS: AMOUNT 1, AMOUNT 2, MOD AMT OSC 2, FILTER, SWITCH, VOLUME.

MODULATION: LFO MODULATION, DESTINATION, OSC 1 FREQ, OSC 2 FREQ, OSC 3 FREQ, OSC 1 PW, OSC 2 PW, OSC 3 PW, OSC 1 INVERT, OSC 2 INVERT, OSC 3 INVERT, FILTER CONTOUR, OSC 1 AMOUNT, OSC 2 AMOUNT, OSC 3 AMOUNT, VOICE MODULATION, DESTINATION, OSC 1 FREQ, OSC 2 FREQ, OSC 3 FREQ, OSC 1 PW, OSC 2 PW, OSC 3 PW, OSC 1 INVERT, OSC 2 INVERT, OSC 3 INVERT, FILTER CONTOUR, OSC 1 AMOUNT, OSC 2 AMOUNT, OSC 3 AMOUNT.

OSCILLATORS: OCTAVE, SYNC 2 TO 1, PULSE WIDTH (N), WAVESHARE, FREQUENCY, KEYBOARD CONTROL, LOW.

MIXER: LEVEL, NOISE.

VOLTAGE CONTROLLED FILTER: KEY TRACK, CUTOFF, EMPHASIS, CONTOUR AMOUNT, RELEASE, UNCONDITIONAL CONTOUR, KEYBOARD FOLLOW, RETURN TO ZERO, ATTACK, DECAY, SUSTAIN, RELEASE.

OUTPUTS: MASTER VOLUME, HEADPHONE VOLUME, PROGRAMMABLE.

### 38. UNCONDITIONAL CONTOUR

The Unconditional Contour completes a note's cycle whether or not the key is held down; the Keyboard Follow makes that cycle shorter toward the top of the keyboard.

**39. VIBES**

SYSTEM CONTROLLER: RECORD INTERLOCK, PROGRAM, ENTER, 1-9, 0, A, B, C, D.

FOOTS: AMOUNT 1, AMOUNT 2, MOD AMT OSC 2, FILTER, SWITCH, VOLUME.

MODULATION: LFO MODULATION, DESTINATION, OSC 1 FREQ, OSC 2 FREQ, OSC 3 FREQ, OSC 1 PW, OSC 2 PW, OSC 3 PW, OSC 1 INVERT, OSC 2 INVERT, OSC 3 INVERT, FILTER CONTOUR, OSC 1 AMOUNT, OSC 2 AMOUNT, OSC 3 AMOUNT, VOICE MODULATION, DESTINATION, OSC 1 FREQ, OSC 2 FREQ, OSC 3 FREQ, OSC 1 PW, OSC 2 PW, OSC 3 PW, OSC 1 INVERT, OSC 2 INVERT, OSC 3 INVERT, FILTER CONTOUR, OSC 1 AMOUNT, OSC 2 AMOUNT, OSC 3 AMOUNT.

OSCILLATORS: OCTAVE, SYNC 2 TO 1, PULSE WIDTH (N), WAVESHARE, FREQUENCY, KEYBOARD CONTROL, LOW.

MIXER: LEVEL, NOISE.

VOLTAGE CONTROLLED FILTER: KEY TRACK, CUTOFF, EMPHASIS, CONTOUR AMOUNT, RELEASE, UNCONDITIONAL CONTOUR, KEYBOARD FOLLOW, RETURN TO ZERO, ATTACK, DECAY, SUSTAIN, RELEASE.

OUTPUTS: MASTER VOLUME, HEADPHONE VOLUME, PROGRAMMABLE.

### 39. VIBES

For more tremolo effect, move the Mod Wheel up to approximately 3/8 to 1/2.

**SYSTEM CONTROLLER**

AUTO TUNE: 0

MICRO MULTIPLE REBOUT TRIGGER: 1

GLIDE: 0

RECORD INTERLOCK: 0

**MODULATION**

OSC 1 FREQ: 62

OSC 2 FREQ: 0

OSC 3 FREQ: 0

MOD AMT 1: 0

MOD AMT 2: 0

**OSCILLATORS**

OCTAVE: 16', 8', 4', 2'

WAVESHARE: 1, 2, 3, 4, 5, 6, 7, 8, 9, 10, 11, 12, 13, 14, 15, 16

PULSE WIDTH (NS): 1, 50, 100

FREQUENCY: 48

KEYBOARD CONTROL: 0

**MIXER**

LEVEL: 40

NOISE: 0

**VOLTAGE CONTROLLED FILTER**

KB TRACK: 74

CUTOFF: 14

EMPHASIS: 57

CONTOUR AMOUNT: 60

UNCONDITIONAL CONTOUR: 0

RETURN TO ZERO: 27

ATTACK: 1

DECAY: 54

RELEASE: 100

**OUTPUTS**

MASTER VOLUME: 0

PROGRAMMABLE: 72

HEADPHONE VOLUME: 0

Turning up the Mod Wheel adds a tremolo effect.

40. SYNC SWEEP

**SYSTEM CONTROLLER**

AUTO TUNE: 0

MICRO MULTIPLE REBOUT TRIGGER: 1

GLIDE: 50

RECORD INTERLOCK: 0

**MODULATION**

OSC 1 FREQ: 55

OSC 2 FREQ: 0

OSC 3 FREQ: 0

MOD AMT 1: 0

MOD AMT 2: 0

**OSCILLATORS**

OCTAVE: 16', 8', 4', 2'

WAVESHARE: 1, 2, 3, 4, 5, 6, 7, 8, 9, 10, 11, 12, 13, 14, 15, 16

PULSE WIDTH (NS): 1, 48, 100

FREQUENCY: 48

KEYBOARD CONTROL: 0

**MIXER**

LEVEL: 48

NOISE: 0

**VOLTAGE CONTROLLED FILTER**

KB TRACK: 0

CUTOFF: 51

EMPHASIS: 21

CONTOUR AMOUNT: 0

UNCONDITIONAL CONTOUR: 34

RETURN TO ZERO: 33

ATTACK: 61

DECAY: 100

RELEASE: 70

**OUTPUTS**

MASTER VOLUME: 0

PROGRAMMABLE: 42

HEADPHONE VOLUME: 0

To add more animation to the sound, turn up the Mod Wheel (or the Modulation Amount control).

41. STRING 5





**SYSTEM CONTROLLER**

PROGRAM

RECORD INTERLOCK

ENTER

A B C D

1 2 3 4 5 6 7 8 9 0

**PEDESTALS**

AMOUNT 1

PITCH

AMOUNT 2

MOD AMT OSC 2

**MODULATION**

LFO MODULATION

DESTINATION

OSC 1 FREQ OSC 2 FREQ OSC 3 FREQ

OSC 1 PW OSC 2 PW OSC 3 PW

OSC 1 INVERT OSC 2 INVERT OSC 3 INVERT

VOICE MODULATION

FILTER CONTOUR OSC 3 AMOUNT

DESTINATION

OSC 1 FREQ OSC 2 FREQ OSC 3 FREQ

OSC 1 PW OSC 2 PW OSC 3 PW

OSC 1 INVERT OSC 2 INVERT OSC 3 INVERT

**OSCILLATORS**

OCTAVE

WAVESHARE

PULSE WIDTH (NS)

FREQUENCY

KEYBOARD CONTROL

**MIXER**

LEVEL

NOISE

**VOLTAGE CONTROLLED FILTER**

CUTOFF

EMPHASIS

CONTOUR AMOUNT

UNCONDITIONAL FOLLOW

KEYBOARD RELEASE

ATTACK

DECAY

RELEASE

**OUTPUTS**

MASTER VOLUME

PROGRAMMABLE

HEADPHONE VOLUME

46. SYNC SWEEP 2

Pedal 2 (or the Mod Wheel) will add more animation to the sound.

**SYSTEM CONTROLLER**

PROGRAM

RECORD INTERLOCK

ENTER

A B C D

1 2 3 4 5 6 7 8 9 0

**PEDESTALS**

AMOUNT 1

PITCH

AMOUNT 2

MOD AMT OSC 2

**MODULATION**

LFO MODULATION

DESTINATION

OSC 1 FREQ OSC 2 FREQ OSC 3 FREQ

OSC 1 PW OSC 2 PW OSC 3 PW

OSC 1 INVERT OSC 2 INVERT OSC 3 INVERT

VOICE MODULATION

FILTER CONTOUR OSC 3 AMOUNT

DESTINATION

OSC 1 FREQ OSC 2 FREQ OSC 3 FREQ

OSC 1 PW OSC 2 PW OSC 3 PW

OSC 1 INVERT OSC 2 INVERT OSC 3 INVERT

**OSCILLATORS**

OCTAVE

WAVESHARE

PULSE WIDTH (NS)

FREQUENCY

KEYBOARD CONTROL

**MIXER**

LEVEL

NOISE

**VOLTAGE CONTROLLED FILTER**

CUTOFF

EMPHASIS

CONTOUR AMOUNT

UNCONDITIONAL FOLLOW

KEYBOARD RELEASE

ATTACK

DECAY

RELEASE

**OUTPUTS**

MASTER VOLUME

PROGRAMMABLE

HEADPHONE VOLUME

47. CELESTE

The character of this voice will change dramatically if the left-hand Octave controls are changed to -1.

48. SYNC SWEEP 3

The sync sweep effect is slow while keys are held down and accelerates when the key is released.

49. HARPSICHORD 1

Modulation can be introduced from Pedal 2 and/or the Mod Wheel.







**SYSTEM CONTROLLER**

PROGRAM

RECORD INTERLOCK

ENTER

0 1 2 3 4 5 6 7 8 9

**FOOT PEDALS**

AMOUNT 1

PITCH

VOLUME

FILTER

AMOUNT 2

MOD AMT OSC 2

**MODULATION**

LF0 MODULATION

DESTINATION

OSC 1 FREQ OSC 2 FREQ OSC 3 FREQ

VOICE MODULATION

OSC 1 FREQ OSC 2 FREQ OSC 3 FREQ

CONTROUR OSC 3 AMOUNT

INVERT

**OSCILLATORS**

OCTAVE

16' 8' 4' 2'

WAVESHAP

PULSE WIDTH (N)

50

1 54 2 54 3 50

**MIXER**

LEVEL

0 5 10

49 52 47 0

**VOLTAGE CONTROLLED FILTER**

KEY TRACK

1/3 2/3

ATTACK

700 1.5 400 1.5 100 1.5

1 MSEC 10 SEC 2 MSEC 20 SEC

UNCONDITIONAL CONTROUR FOLLOW

KEYBOARD FOLLOW

RELEASE

1.4 2 3 1.4 2 3

800 200 400 800 200 400

2 MSEC 20 SEC 2 MSEC 20 SEC

ATTACK DECAY SUSTAIN RELEASE

0 33 44

**OUTPUTS**

PROGRAMMABLE MASTER VOLUME

0 10

40

HEADPHONE VOLUME

0 10

**54. MONO 1**

OCTAVE

PITCH

MOD

Experiment with the Pitch Bend and Mod Wheels. This voice is programmed for low-note priority; try the other modes. Pedal 1 will control Filter Cutoff.

**SYSTEM CONTROLLER**

PROGRAM

RECORD INTERLOCK

ENTER

0 1 2 3 4 5 6 7 8 9

**FOOT PEDALS**

AMOUNT 1

PITCH

VOLUME

FILTER

AMOUNT 2

MOD AMT OSC 2

**MODULATION**

LF0 MODULATION

DESTINATION

OSC 1 FREQ OSC 2 FREQ OSC 3 FREQ

VOICE MODULATION

OSC 1 FREQ OSC 2 FREQ OSC 3 FREQ

CONTROUR OSC 3 AMOUNT

INVERT

**OSCILLATORS**

OCTAVE

16' 8' 4' 2'

WAVESHAP

PULSE WIDTH (N)

50

1 88 2 50 3 48

**MIXER**

LEVEL

0 5 10

43 38 0 0

**VOLTAGE CONTROLLED FILTER**

KEY TRACK

1/3 2/3

ATTACK

400 1.5 100 1.5 100 1.5

1 MSEC 10 SEC 2 MSEC 20 SEC

UNCONDITIONAL CONTROUR FOLLOW

KEYBOARD FOLLOW

RELEASE

1.4 2 3 1.4 2 3

800 200 400 800 200 400

2 MSEC 20 SEC 2 MSEC 20 SEC

ATTACK DECAY SUSTAIN RELEASE

0 42 46 91

**OUTPUTS**

PROGRAMMABLE MASTER VOLUME

0 10

49

HEADPHONE VOLUME

0 10

**55. UFO**

OCTAVE

PITCH

MOD

The Pitch Wheel is programmed at maximum; it can speed up, slow down, or reverse the falling effect.

**SYSTEM CONTROLLER**

PROGRAM

1 2 3 4 5 6 7 8 9 0 ENTER

RECORD INTERLOCK

**PEAK PEDALS**

AMOUNT 1

PITCH

FILTER

MOD AMT 2

OSC 2

**OSCILLATORS**

OCTAVE

16" 8" 4" 2" 1"

50 PULSE WIDTH (IN)

1 13

2 14

3 50

FREQUENCY

0 21 3

2 48

4 7

8 4

16 8

32 4

64 2

128 1

256 0

512 0

1024 0

2048 0

4096 0

8192 0

16384 0

32768 0

65536 0

131072 0

262144 0

524288 0

1048576 0

2097152 0

4194304 0

8388608 0

16777216 0

33554432 0

67108864 0

134217728 0

268435456 0

536870912 0

1073741824 0

2147483648 0

4294967296 0

8589934592 0

17179869184 0

34359738368 0

68719476736 0

137438953472 0

274877906944 0

549755813888 0

1099511627776 0

2199023255552 0

4398046511104 0

8796093022208 0

17592186044416 0

35184372088832 0

70368744177664 0

140737488355328 0

281474976710656 0

562949953421312 0

1125899906842624 0

2251799813685248 0

4503599627370496 0

9007199254740992 0

18014398509481984 0

36028797018963968 0

72057594037927936 0

144115188075855872 0

288230376151711744 0

576460752303423488 0

1152921504606846976 0

2305843009213693952 0

4611686018427387904 0

9223372036854775808 0

18446744073709551616 0

36893488147419103232 0

73786976294838206464 0

147573952589676412928 0

295147905179352825856 0

590295810358705651712 0

1180591620717411303424 0

2361183241434822606848 0

4722366482869645213696 0

9444732965739290427392 0

18889465931478580854784 0

37778931862957161709568 0

75557863725914323419136 0

151115727451828646838272 0

302231454903657293676544 0

604462909807314587353088 0

1208925819614629174706176 0

2417851639229258349412352 0

4835703278458516698824704 0

9671406556917033397649408 0

19342813113834066795298816 0

38685626227668133590597632 0

77371252455336267181195264 0

154742504910672534362390528 0

309485009821345068724781056 0

618970019642690137449562112 0

1237940039285380274899124224 0

2475880078570760549798248448 0

4951760157141521099596496896 0

9903520314283042199192993792 0

19807040628566084398385987584 0

39614081257132168796771975168 0

79228162514264337593543950336 0

158456325028528675187087900672 0

316912650057057350374175801344 0

633825300114114700748351602688 0

1267650600228229401496703205376 0

2535301200456458802993406410752 0

5070602400912917605986812821504 0

10141204801825835211973625643008 0

20282409603651670423947251286016 0

40564819207303340847894502572032 0

81129638414606681695789005144064 0

162259276829213363911578010288128 0

324518553658426727823156020576256 0

649037107316853455646312041152512 0

1298074214633707111292624082305024 0

2596148429267414222585248164610048 0

5192296858534828445170496329220096 0

10384593717069656890340996584440192 0

20769187434139313780681993168880384 0

41538374868278627561363983337760768 0

83076749736557255122727966675521536 0

166153499473114510245455933351042672 0

33230699894622902049091186670204544 0

66461399789245804098183733340409088 0

132922799578491608196367466680818176 0

2658455991569832163927349333616353536 0

5316911983139664327854698667233067072 0

10633823966279328655709397334466134144 0

21267647932558657311418794668932268288 0

4253529586511731462283758933786453657728 0

8507059173023462924567517867572907315456 0

17014118346046925849135035735147814630912 0

34028236692093851698270071470295629261824 0

6805647338418770339654014294059125833648 0

136112946768375406793080285881184716667904 0

272225893536750813586160571762369433334816 0

544451787073501627172321143524738866668832 0

1088903574147003254344642287049477733337664 0

2177807148294006508689284574098954666675328 0

4355614296588013017378569148197909333350656 0

87112285931760260347571382963958186670131132128 0

17422457186352052069514276592791633422226256 0

3484491437270410413902855318558326684445311328 0

69689828745408208278057106371166533688906256 0

139379657490816416556114212742333173777812512 0

278759314981632833112228425484666347555625024 0

55751862996326566622445685096933275111125048 0

111503725992653133244891371937866550222250096 0

2230074519853062664897827438757330044450192 0

446014903970612532979565487751466008890384 0

892029807941225065959130975502921177806768 0

1784059615882450131918261910005823556133536 0

3568119231764900263836523820011651712267072 0

71362384635298005276730476400233034245344 0

1427247692705960105534609528004660684810688 0

28544953854119202110692118560093213697217728 0

57089907708238404221384231120018643394435456 0

114179815416476808442768462240037286788870912 0

2283596308329536168855369248007457357777812512 0

4567192616659072337710738496001494715555625024 0

913438523331814467542147699200298943111125048 0

1826877046663628935084295398400597886222250096 0

365375409332725787016859079680119577244450192 0

730750818665451574033718159360239548890384 0

14615016373309031480674363187204791177806768 0

29230032746618062961348727374409583556133536 0

5846006549323612592269744674881916712267072 0

116920130986472251845394913497638334245344 0

233840261972944503690789826995276668870912 0

4676805239458890073815796539910533777812512 0

9353610478917780147631593079821067555625024 0

1870722095783556029526318159360213511125048 0

374144419156711205905263639840022622250096 0

748288838313422411810527279680045244450192 0

14965776766268442362105545936009048890384 0

299315535325368847242110898720180977812512 0

5986310706507376944842217974403619555625024 0

1197262141301475388968443594880723911125048 0

2394524282602950777936887189760144822250096 0

478904856520590155587377437952028944450192 0

9578097130411803111747548759040578890384 0

191561942608236062354950951808115777812512 0

3831238852164721247099019036162355625024 0

766247770432944249419803807232471125048 0

1532495440865888498839607614462355625024 0

306499088173177699767921522892471125048 0

6129981763463553995358430577849431125048 0

12259963526927107990716861095698862250096 0

245199270538542159814337221913977250096 0

49039854107708431962867444382795450192 0

9807970821541686392573488876559090384 0

196159416430833727515469775311181812512 0

3923188328616674550309395506223635312512 0

78463766572333491006189100124672655625024 0

1569275331446669820123782002493451125048 0

313855066289333964024756400498692250096 0

62771013257866792804951288099738450192 0

12554202651573358560990257919947700384 0

251084053031467171219805154393994400768 0

50216810606293434243961028788798801536 0

1004336212125868684879220575775976256 0

2008672424251737369758441151551952512 0

4017344848503474739516882303103905024 0

803468969700694947903376460620781024 0

1606937939401389895806752921215640512 0

3213875878802779791613505842431281024 0

6427751757605559583227011684862562048 0

12855503515211119166454223369725124096 0

25711007030422238332908447138450248192 0

51422014060844476665816894276900496 0

102844028121688953331637788553800992 0

20568805624337790666327557710761984 0

41137611248675581332655115421523968 0

822752224973511626531108428430784 0

1645504449947023253062216568615616 0

3291008899894046506124433137231232 0

658201779978809301224886627446256 0

1316403559957618602449773294892512 0

2632807119915237204899546589785024 0

5265614239830474409799093979570048 0

10531228479660948819598187959140096 0

21062456959321897639196375918280192 0

42124913918643795278392751836560384 0

84249827837287590556785503673120768 0

168499657674575181113571107346241536 0

33699931534915036222714221469242784 0

67399863069830072445428443139485568 0

134799726139660144890856886278971136 0

269599452279320289781713772557922784 0

539198904558640579563427545115975568 0

1078397809117281159126855090231911136 0

2156795618234562318253710180463822784 0

431359123646912463650742036092765568 0

862718247293824927301484072185531136 0

17254364945876498546029681443710622784 0

3450872989175299709205936288742125568 0

6901745978350599418401172577484251136 0

13803491956701198368023445154885022784 0

276069839134023967360468903097705568 0

552139678268047934720937806195411136 0

1104279376536095869441875612308222784 0

2208558753072191738883751224616445568 0

4417117506144383477767502449232891136 0

883423501228876695553500488457822784 0

176684700245775339110700097691565568 0

353369400491550678221400195383131136 0

7067388009831013564428003907662622784 0

1413477601966202712885600781532525568 0

2826955203932405425771201563065051136 0

5653910407864810851542403126130022784 0

1130782081572962170308480625226005568 0

2261564163145924340616961250452011136 0

4523128326291848681233392500904022784 0

904625665258369736246678500180805568 0

180925133051673947249335700361611136 0

361850266103347894498671400723222784 0

72370053220669578899734280144645568 0

144740106441339157799468560289281136 0

2894802128826783155989371205785622784 0

578960425765356631197874241157125568 0

1157920851530713263957488482314251136 0

23158417030614265279149766446285022784 0

4631683406122853055829953289257005568 0

9263366812245706111659906578514011136 0

185267336244914122233198131570222784 0

370534672489828244466396263140445568 0

741069344979656488932792526280891136 0

14821386899593129786655850525617822784 0

29642773799186259573311701051325568 0

59285547598372519146623402102511136 0

118571095176745038293246804205022784 0

237142190353490076586493608410045568 0

474284380706980153172987216820091136 0

9485687614139603063459744336401822784 0

1897137522827920612711918867283645568 0

3794275045655841225423837734567291136 0

758855009131168245084767546913445568 0

151771001826236490168953509826891136 0

3035420036524729803379070196537822784 0

6070840073049459606758140393075645568 0

121416801460989192135162807861511136 0

242833602921978384270325615723022784 0

485667205843956768540651234446045568 0

971334411687913537081302468892091136 0

1942668835375827074162604937841822784 0

3885337670751654148325209875683645568 0

7770675341503308296650419751367291136 0

155413506830066157333008395027445568 0

310827013660132314666016790054891136 0

6216540273202646293320335801097822784 0

12433080546405292586640671602195645568 0

248661610928105851732813344043911136 0

497323221856211703465626688087822784 0

994646443712423406931253376175645568 0

19892928874248468138625067523511136 0

39785857748496936277250135047022784 0

79571715496993872554500270094045568 0

159143430993987745109000540188091136 0

3182868619879754902180010803761822784 0

6365737239759509804360021607523645568 0

12731474479519019608720043215047291136 0

254629489590380392174400864300945568 0

509258979180760784348801728601891136 0

10185179583615215686976034721237822784 0

20370359167230431373952069442475568 0

407407183344608627479041388849511136 0

81481436668921725495808277799022784 0

16296287337783545099161555598045568 0

32592574675567090198323111196091136 0

651851493511341803966462223921822784 0

1303702987022683607932924447843645568 0

2607405974045367215865848895687291136 0

52148119480907344317316977913745568 0

10429623896181468863463395482745568 0

20859247792362937726926790965491136 0

417184955847258754538535819309822784 0

834369911694517509077071686019645568 0

166873982338903501815414233



**SYSTEM CONTROLLER**  
 PROGRAM: [ ]  
 1 2 3 4 5 6 7 8 9 0  
 RECORD INTERLOCK ENTER

**FOOT PEDALS**  
 AMOUNT 1: 0  
 AMOUNT 2: 0  
 FILTER VOLUME  
 MOD AMT OSC 2

**MODULATION**  
 LFO MODULATION: 60  
 OSC 1 FREQ: 100  
 OSC 2 FREQ: 25  
 OSC 3 FREQ: 5  
 VOICE MODULATION: 97  
 OSC 1 FREQ: 100  
 OSC 2 FREQ: 25  
 OSC 3 FREQ: 5

**OSCILLATORS**  
 OSC 1: 1 (PULSE WIDTH: 50)  
 OSC 2: 2 (PULSE WIDTH: 13)  
 OSC 3: 3 (PULSE WIDTH: 42)  
 OCTAVE: 16 8 4 2

**MIXER**  
 LEVEL: 45, 50, 0, 0  
 NOISE: 0, 0

**VOLTAGE CONTROLLED FILTER**  
 CUTOFF: 10, 68  
 EMPHASIS: 22  
 CONTOUR AMOUNT: 44  
 SUSTAIN: 18  
 RELEASE: 55  
 KEYBOARD FOLLOW: 68  
 UNCONDITIONAL CONTOUR: 62  
 RETURN TO ZERO: 48

**OUTPUTS**  
 MASTER VOLUME: 100  
 HEADPHONE VOLUME: 0

**60. FM 1**

This sound is produced by audio-range modulation of the Filter. The Mod Wheel will introduce vibrato.

**SYSTEM CONTROLLER**  
 PROGRAM: [ ]  
 1 2 3 4 5 6 7 8 9 0  
 RECORD INTERLOCK ENTER

**FOOT PEDALS**  
 AMOUNT 1: 0  
 AMOUNT 2: 0  
 FILTER VOLUME  
 MOD AMT OSC 2

**MODULATION**  
 LFO MODULATION: 56  
 OSC 1 FREQ: 100  
 OSC 2 FREQ: 25  
 OSC 3 FREQ: 5  
 VOICE MODULATION: 27  
 OSC 1 FREQ: 100  
 OSC 2 FREQ: 25  
 OSC 3 FREQ: 5

**OSCILLATORS**  
 OSC 1: 1 (PULSE WIDTH: 50)  
 OSC 2: 2 (PULSE WIDTH: 47)  
 OSC 3: 0 (PULSE WIDTH: 0)  
 OCTAVE: 16 8 4 2

**MIXER**  
 LEVEL: 26, 30, 0, 0  
 NOISE: 0, 0

**VOLTAGE CONTROLLED FILTER**  
 CUTOFF: 40, 18  
 EMPHASIS: 44  
 CONTOUR AMOUNT: 44  
 SUSTAIN: 32  
 RELEASE: 71  
 KEYBOARD FOLLOW: 68  
 UNCONDITIONAL CONTOUR: 62  
 RETURN TO ZERO: 72

**OUTPUTS**  
 MASTER VOLUME: 100  
 HEADPHONE VOLUME: 0

**61. STRING 7**

For more animation to the sound, advance the Mod Wheel 3/8 to 1/2.

62. BRASS 7

This voice is another example of audio-frequency filter modulation. Try different waveshape settings for Osc 3; note the change in timbre.

63. SYNTH ORGAN

Switching the left-hand Octave setting will have a pronounced effect on the tone color of this voice.

64. MONO 2

The LFO setting determines the speed of the Arpeggiator. At high speeds, the tremolo effect becomes more pronounced.

65. SYNC SWEEP 4

The reiterating effect comes from LFO Modulation; the long fall effect is from the Voice Modulation section. Pedal 2 controls additional sync effects.





### 68. WIND CHIMES 2

This is an example of "cascaded" modulation; the LFO modulates Osc 3, which in turn modulates the Filter. Note that the chime effect on any one voice subtly speeds up and slows down.

### 69. ELECTRIC PIANO 3

For more animation in the sound, turn up the Mod Wheel. Pedal 1 will control brightness.

**SYSTEM CONTROLLER**

PROGRAM

1 2 3 4 5 6 7 8 9 0

RECORD INTERLOCK

ENTER

**FOOT PEDALS**

AMOUNT 1

AMOUNT 2

PITCH

VOLUME

FILTER

MOD AMT OSC 2

**MODULATION**

LEO MODULATION

DESTINATION

OSC 1 FREQ OSC 2 FREQ OSC 3 FREQ

OSC 1 PW1 OSC 2 PW2 OSC 3 PW3

VOICE MODULATION

OSC 1 FREQ OSC 2 FREQ OSC 3 FREQ

OSC 1 PW1 OSC 2 PW2 OSC 3 PW3

OSC 3 AMOUNT

CONToured INVERT

**OSCILLATORS**

OCTAVE

16' 8' 4' 2' 0' 2' 4' 8' 16'

WAVESHAPe

PULSE WIDTH (N)

FREQUENCY

KEYBOARD CONTROL

LOW

**MIXER**

LEVEL

NOISE

**VOLTAGE CONTROLLED FILTER**

KB TRACK

CUTOFF

EMPHASIS

CONTOUR AMOUNT

UNCONDITIONAL FOLLOW

UNCONDITIONAL CONTour

ATTACK

DECAY

RELEASE

**OUTPUTS**

PROGRAMMABLE

VOLUME

HEADPHONE

VOLUME

70. BOWED OCTAVES

OCTAVE

MOD

The key to this patch is using pulse waves that are nearly mirror images: Osc 1 at 11%, Osc 2 at 94%. The Voice Modulation section first drives one oscillator to 0%, then the other, resulting in a smooth transition between octaves.

**SYSTEM CONTROLLER**

PROGRAM

1 2 3 4 5 6 7 8 9 0

RECORD INTERLOCK

ENTER

**FOOT PEDALS**

AMOUNT 1

AMOUNT 2

PITCH

VOLUME

FILTER

MOD AMT OSC 2

**MODULATION**

LEO MODULATION

DESTINATION

OSC 1 FREQ OSC 2 FREQ OSC 3 FREQ

OSC 1 PW1 OSC 2 PW2 OSC 3 PW3

VOICE MODULATION

OSC 1 FREQ OSC 2 FREQ OSC 3 FREQ

OSC 1 PW1 OSC 2 PW2 OSC 3 PW3

OSC 3 AMOUNT

CONToured INVERT

**OSCILLATORS**

OCTAVE

16' 8' 4' 2' 0' 2' 4' 8' 16'

WAVESHAPe

PULSE WIDTH (N)

FREQUENCY

KEYBOARD CONTROL

LOW

**MIXER**

LEVEL

NOISE

**VOLTAGE CONTROLLED FILTER**

KB TRACK

CUTOFF

EMPHASIS

CONTOUR AMOUNT

UNCONDITIONAL FOLLOW

UNCONDITIONAL CONTour

ATTACK

DECAY

RELEASE

**OUTPUTS**

PROGRAMMABLE

VOLUME

HEADPHONE

VOLUME

71. STRING 8

OCTAVE

MOD

Additional modulation can be introduced from Pedal 2 and/or the Mod Wheel.



**74. MONO 3**

**74. MONO 3**

This is not a true mono voice; only one voice card is triggered at a time, but the long release allows voices to overlap.

**75. QUINT FILTER TRILL**

**75. QUINT FILTER TRILL**

The high Filter Sustain level keeps the trill effect from "falling" until keys are released.



78. SYNTH PLECTRUM

Pedal 2 can control Filter Cutoff; the Mod Wheel will introduce vibrato.

79. SYNC 5

Pedal 2 can be used to change the basic tone color of the initial sound; the Mod Wheel will add vibrato.



82. BRASS 9

The Keyboard Follow produces faster contours for higher notes in a manner characteristic of conventional brass instruments.

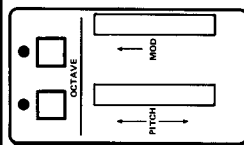

83. SURPRISE

Short notes produce a pleasant, flute-like timbre; the longer they're held, the nastier they get!

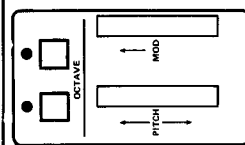



**SYSTEM CONTROLLER**

PROGRAM

1 2 3 4 5 6 7 8 9 0

RECORD INTERLOCK ENTER

**FOOT PEDALS**

AMOUNT 1

0 2 4 6 8 10

PITCH MOD

AMOUNT 2

0 2 4 6 8 10

MOD AMT OSC 2

**MODULATION**

LED MODULATION

RATE (HZ)

5 1 25 50 100

OSC 1 FREQ OSC 2 FREQ

DESTINATION

PW1 PW2 PW3

OSC AMOUNT

CONTAMOUNT INVERT

OSC 1 FREQ OSC 2 FREQ

**OSCILLATORS**

OCTAVE

16' 8' 4' 2'

WAVE SHAPE

PULSE WIDTH (IN)

50 100

FREQUENCY

0 50 100

KEYBOARD CONTROL

LOW

**MIXER**

LEVEL

0 2 4 6 8 10

NOISE

**VOLTAGE CONTROLLED FILTER**

KB TRACK

1/3 2/3

CUTOFF

0 2 4 6 8

EMPHASIS

0 2 4 6 8

CONTOUR AMOUNT

0 2 4 6 8

RELEASE

1.4 2 3 6

UNCONDITIONAL FOLLOW

0 2 4 6 8

KEYBOARD FOLLOW

0 2 4 6 8

RELEASE

1.4 2 3 6

ATTACK

0 2 4 6 8

DECAY

0 2 4 6 8

SUSTAIN

0 2 4 6 8

RELEASE

1.4 2 3 6

**OUTPUTS**

PROGRAMMABLE

0 2 4 6 8

VOLUME

0 2 4 6 8

HEADPHONE

0 2 4 6 8

VOLUME

### 84. MONO 4

This is an example of audio-frequency modulation of the synced Osc 2. Note that multiple triggering is active; this ensures clean playing at rapid tempos.

**SYSTEM CONTROLLER**

PROGRAM

1 2 3 4 5 6 7 8 9 0

RECORD INTERLOCK ENTER

**FOOT PEDALS**

AMOUNT 1

0 2 4 6 8 10

PITCH MOD

AMOUNT 2

0 2 4 6 8 10

MOD AMT OSC 2

**MODULATION**

LED MODULATION

RATE (HZ)

5 1 25 50 100

OSC 1 FREQ OSC 2 FREQ

DESTINATION

PW1 PW2 PW3

OSC AMOUNT

CONTAMOUNT INVERT

OSC 1 FREQ OSC 2 FREQ

**OSCILLATORS**

OCTAVE

16' 8' 4' 2'

WAVE SHAPE

PULSE WIDTH (IN)

50 100

FREQUENCY

0 50 100

KEYBOARD CONTROL

LOW

**MIXER**

LEVEL

0 2 4 6 8 10

NOISE

**VOLTAGE CONTROLLED FILTER**

KB TRACK

1/3 2/3

CUTOFF

0 2 4 6 8

EMPHASIS

0 2 4 6 8

CONTOUR AMOUNT

0 2 4 6 8

RELEASE

1.4 2 3 6

UNCONDITIONAL FOLLOW

0 2 4 6 8

KEYBOARD FOLLOW

0 2 4 6 8

RELEASE

1.4 2 3 6

ATTACK

0 2 4 6 8

DECAY

0 2 4 6 8

SUSTAIN

0 2 4 6 8

RELEASE

1.4 2 3 6

**OUTPUTS**

PROGRAMMABLE

0 2 4 6 8

VOLUME

0 2 4 6 8

HEADPHONE

0 2 4 6 8

VOLUME

### 85. DROPOFF

The dropoff effect will occur only when a key is released. The Filter Contour (with maximum sustain) is routed to the oscillators.

**SYSTEM CONTROLLER**

PROGRAM

1 2 3 4 5 6 7 8 9 0

RECORD INTERLOCK ENTER

**FOOT PEDALS**

AMOUNT 1

0 2 4 6 8 10

PITCH MOD

AMOUNT 2

0 2 4 6 8 10

MOD AMT OSC 2

**MODULATION**

LED MODULATION

RATE (HZ)

5 1 25 50 100

OSC 1 FREQ OSC 2 FREQ

DESTINATION

PW1 PW2 PW3

OSC AMOUNT

CONTAMOUNT INVERT

OSC 1 FREQ OSC 2 FREQ

**OSCILLATORS**

OCTAVE

16' 8' 4' 2'

WAVE SHAPE

PULSE WIDTH (IN)

50 100

FREQUENCY

0 50 100

KEYBOARD CONTROL

LOW

**MIXER**

LEVEL

0 2 4 6 8 10

NOISE

**VOLTAGE CONTROLLED FILTER**

KB TRACK

1/3 2/3

CUTOFF

0 2 4 6 8

EMPHASIS

0 2 4 6 8

CONTOUR AMOUNT

0 2 4 6 8

RELEASE

1.4 2 3 6

UNCONDITIONAL FOLLOW

0 2 4 6 8

KEYBOARD FOLLOW

0 2 4 6 8

RELEASE

1.4 2 3 6

ATTACK

0 2 4 6 8

DECAY

0 2 4 6 8

SUSTAIN

0 2 4 6 8

RELEASE

1.4 2 3 6

**OUTPUTS**

PROGRAMMABLE

0 2 4 6 8

VOLUME

0 2 4 6 8

HEADPHONE

0 2 4 6 8

VOLUME

**SYSTEM CONTROLLER**

PROGRAM

1 2 3 4 5 6 7 8 9 0

RECORD INTERLOCK ENTER

**FOOT PEDALS**

AMOUNT 1

0 2 4 6 8 10

PITCH MOD

AMOUNT 2

0 2 4 6 8 10

MOD AMT OSC 2

**MODULATION**

LED MODULATION

RATE (HZ)

5 1 25 50 100

OSC 1 FREQ OSC 2 FREQ

DESTINATION

PW1 PW2 PW3

OSC AMOUNT

CONTAMOUNT INVERT

OSC 1 FREQ OSC 2 FREQ

**OSCILLATORS**

OCTAVE

16' 8' 4' 2'

WAVE SHAPE

PULSE WIDTH (IN)

50 100

FREQUENCY

0 50 100

KEYBOARD CONTROL

LOW

**MIXER**

LEVEL

0 2 4 6 8 10

NOISE

**VOLTAGE CONTROLLED FILTER**

KB TRACK

1/3 2/3

CUTOFF

0 2 4 6 8

EMPHASIS

0 2 4 6 8

CONTOUR AMOUNT

0 2 4 6 8

RELEASE

1.4 2 3 6

UNCONDITIONAL FOLLOW

0 2 4 6 8

KEYBOARD FOLLOW

0 2 4 6 8

RELEASE

1.4 2 3 6

ATTACK

0 2 4 6 8

DECAY

0 2 4 6 8

SUSTAIN

0 2 4 6 8

RELEASE

1.4 2 3 6

**OUTPUTS**

PROGRAMMABLE

0 2 4 6 8

VOLUME

0 2 4 6 8

HEADPHONE

0 2 4 6 8

VOLUME

**SYSTEM CONTROLLER**

PROGRAM

1 2 3 4 5 6 7 8 9 0

RECORD INTERLOCK ENTER

**FOOT PEDALS**

AMOUNT 1

0 2 4 6 8 10

PITCH MOD

AMOUNT 2

0 2 4 6 8 10

MOD AMT OSC 2

**MODULATION**

LED MODULATION

RATE (HZ)

5 1 25 50 100

OSC 1 FREQ OSC 2 FREQ

DESTINATION

PW1 PW2 PW3

OSC AMOUNT

CONTAMOUNT INVERT

OSC 1 FREQ OSC 2 FREQ

**OSCILLATORS**

OCTAVE

16' 8' 4' 2'

WAVE SHAPE

PULSE WIDTH (IN)

50 100

FREQUENCY

0 50 100

KEYBOARD CONTROL

LOW

**MIXER**

LEVEL

0 2 4 6 8 10

NOISE

**VOLTAGE CONTROLLED FILTER**

KB TRACK

1/3 2/3

CUTOFF

0 2 4 6 8

EMPHASIS

0 2 4 6 8

CONTOUR AMOUNT

0 2 4 6 8

RELEASE

1.4 2 3 6

UNCONDITIONAL FOLLOW

0 2 4 6 8

KEYBOARD FOLLOW

0 2 4 6 8

RELEASE

1.4 2 3 6

ATTACK

0 2 4 6 8

DECAY

0 2 4 6 8

SUSTAIN

0 2 4 6 8

RELEASE

1.4 2 3 6

**OUTPUTS**

PROGRAMMABLE

0 2 4 6 8

VOLUME

0 2 4 6 8

HEADPHONE

0 2 4 6 8

VOLUME

**86. RING MOD**

**86. RING MOD**

The ring mod effect shifts upward because the Filter Contour voltage sent to Osc 2 has been inverted.

**87. HARPSICHORD 2**

**87. HARPSICHORD 2**

A small amount of Filter Contour sent to the pulse width of Osc 2 enhances the brilliance of the plucking effect.





**92. BRASS 10**

**SYSTEM CONTROLLER**

PROGRAM

1 2 3 4 5 6 7 8 9 0 ENTER

RECORD INTERLOCK

**PEDESTALS**

AMOUNT 1: 25

PITCH

FILTER

AMOUNT 2: 0

MOD AMT OSC 2

**OSCILLATORS**

OCTAVE: 18' 8' 4' 2'

WAVESHAPE

SYNC 2/01

PULSE WIDTH (NS): 50

FREQUENCY: 48

KEYBOARD CONTROL

**MODULATION**

LFO MODULATION: RATE (HZ): 62

DESTINATION: OSC 1, OSC 2, OSC 3, FREQ, OSC, AMT, OSC 2

VOICE MODULATION: OSC 1, OSC 2, OSC 3, FREQ, OSC, AMT, OSC 2

**MIXER**

LEVEL: 100

NOISE: 0

**OSCILLATORS**

OCTAVE: 18' 8' 4' 2'

WAVESHAPE

SYNC 2/01

PULSE WIDTH (NS): 50

FREQUENCY: 48

KEYBOARD CONTROL

**MODULATION**

LFO MODULATION: RATE (HZ): 62

DESTINATION: OSC 1, OSC 2, OSC 3, FREQ, OSC, AMT, OSC 2

VOICE MODULATION: OSC 1, OSC 2, OSC 3, FREQ, OSC, AMT, OSC 2

**MIXER**

LEVEL: 100

NOISE: 0

**VOLTAGE CONTROLLED FILTER**

KB TRACK

CUTOFF: 10

EMPHASIS: 0

CONTOUR AMOUNT: 48

RELEASE: 44

UNCONDITIONAL CONTOUR: 100

KEYBOARD FOLLOW: 71

RETURN TO ZERO: 21

ATTACK: 28

DECAY: 55

SUSTAIN: 55

RELEASE: 44

**VOLTAGE CONTROLLED AMPLIFIER**

ATTACK: 28

DECAY: 55

SUSTAIN: 55

RELEASE: 44

**OUTPUTS**

MASTER VOLUME: 42

HEADPHONE VOLUME: 42

Modulation (vibrato) can be added via the Mod Wheel.

92. BRASS 10

**93. TRIANGLE WAVES**

**SYSTEM CONTROLLER**

PROGRAM

1 2 3 4 5 6 7 8 9 0 ENTER

RECORD INTERLOCK

**PEDESTALS**

AMOUNT 1: 0

PITCH

FILTER

AMOUNT 2: 0

MOD AMT OSC 2

**OSCILLATORS**

OCTAVE: 18' 8' 4' 2'

WAVESHAPE

SYNC 2/01

PULSE WIDTH (NS): 50

FREQUENCY: 85

KEYBOARD CONTROL

**MODULATION**

LFO MODULATION: RATE (HZ): 61

DESTINATION: OSC 1, OSC 2, OSC 3, FREQ, OSC, AMT, OSC 2

VOICE MODULATION: OSC 1, OSC 2, OSC 3, FREQ, OSC, AMT, OSC 2

**MIXER**

LEVEL: 100

NOISE: 0

**OSCILLATORS**

OCTAVE: 18' 8' 4' 2'

WAVESHAPE

SYNC 2/01

PULSE WIDTH (NS): 50

FREQUENCY: 85

KEYBOARD CONTROL

**MODULATION**

LFO MODULATION: RATE (HZ): 61

DESTINATION: OSC 1, OSC 2, OSC 3, FREQ, OSC, AMT, OSC 2

VOICE MODULATION: OSC 1, OSC 2, OSC 3, FREQ, OSC, AMT, OSC 2

**MIXER**

LEVEL: 100

NOISE: 0

**VOLTAGE CONTROLLED FILTER**

KB TRACK

CUTOFF: 27

EMPHASIS: 32

CONTOUR AMOUNT: 66

RELEASE: 73

UNCONDITIONAL CONTOUR: 18

KEYBOARD FOLLOW: 80

RETURN TO ZERO: 66

ATTACK: 0

DECAY: 66

SUSTAIN: 66

RELEASE: 91

**VOLTAGE CONTROLLED AMPLIFIER**

ATTACK: 0

DECAY: 66

SUSTAIN: 66

RELEASE: 91

**OUTPUTS**

MASTER VOLUME: 44

HEADPHONE VOLUME: 44

The triangle waves generate a basic signal unique to the synthesizer. Try this voice with and without Glide.

93. TRIANGLE WAVES

**94. MONO 5**

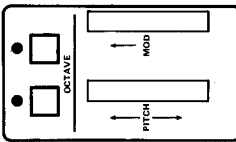

94. MONO 5

Holding down thirds (or other chords) produces a very authentic marimba sound.

**95. RING MOD 2**

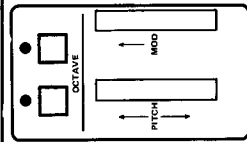

95. RING MOD 2

In this patch, the "ring mod" (audio-frequency modulation) is sent equally to all three oscillators.

96. DUPE # 75

This is a "free" position, useful if you need a temporary holding position while swapping program locations.

97. OCTAVE SYNTH 2

Pedal 1 can control Filter Cutoff (brightness); the Mod Wheel will add vibrato.





**SYSTEM CONTROLLER**

PROGRAM

1 2 3 4 5 6 7 8 9 0

RECORD INTERLOCK ENTER

**LEFT PEDALS**

AMOUNT 1

PITCH

MOD AMT OSC 2

**OSCILLATORS**

1

WAVESHARE

PULSE WIDTH (N)

2

WAVESHARE

PULSE WIDTH (N)

3

WAVESHARE

PULSE WIDTH (N)

**MODULATION**

LED MODULATION

OSC 1 FREQ OSC 2 FREQ OSC 3 FREQ

OSC 1 FREQ OSC 2 FREQ OSC 3 FREQ

VOICE MODULATION

OSC 1 FREQ OSC 2 FREQ OSC 3 FREQ

OSC 1 FREQ OSC 2 FREQ OSC 3 FREQ

**VOLTAGE CONTROLLED FILTER**

18 TRACK

2/3

700 1 1.5

400 2 3

100 3 6

10 4 12

1000 5 24

EMPHASIS

CONTOUR AMOUNT

1.4 2 3

800 4 6

200 5 12

20 6 24

2 7 48

0.2 8 96

0.1 9 192

0.05 10 384

0.02 11 768

0.01 12 1536

24MS/SEC 20SEC

24MS/SEC 20SEC

24MS/SEC 20SEC

24MS/SEC 20SEC

UNCONDITIONAL CONTIN

KEYBOARD FOLLOW

RELEASE

1.4 2 3

800 4 6

200 5 12

20 6 24

2 7 48

0.2 8 96

0.1 9 192

0.05 10 384

0.02 11 768

0.01 12 1536

24MS/SEC 20SEC

24MS/SEC 20SEC

24MS/SEC 20SEC

24MS/SEC 20SEC

RETURN TO ZERO

UNCONDITIONAL CONTIN

KEYBOARD FOLLOW

RELEASE

1.4 2 3

800 4 6

200 5 12

20 6 24

2 7 48

0.2 8 96

0.1 9 192

0.05 10 384

0.02 11 768

0.01 12 1536

24MS/SEC 20SEC

24MS/SEC 20SEC

24MS/SEC 20SEC

24MS/SEC 20SEC

ATTACK

10SEC 20SEC

10SEC 20SEC

10SEC 20SEC

10SEC 20SEC

ATTACK

10SEC 20SEC

10SEC 20SEC

10SEC 20SEC

10SEC 20SEC

**OUTPUTS**

PROGRAMMABLE

MASTER VOLUME

0 10

2 5

PROGRAMMABLE

VOLUME

0 10

2 5

HEADPHONE

0 10

2 5

HEADPHONE

0 10

2 5

VOLUME

**SYSTEM CONTROLLER**

PROGRAM

1 2 3 4 5 6 7 8 9 0

RECORD INTERLOCK ENTER

**LEFT PEDALS**

AMOUNT 1

PITCH

MOD AMT OSC 2

**OSCILLATORS**

1

WAVESHARE

PULSE WIDTH (N)

2

WAVESHARE

PULSE WIDTH (N)

3

WAVESHARE

PULSE WIDTH (N)

**MODULATION**

LED MODULATION

OSC 1 FREQ OSC 2 FREQ OSC 3 FREQ

OSC 1 FREQ OSC 2 FREQ OSC 3 FREQ

VOICE MODULATION

OSC 1 FREQ OSC 2 FREQ OSC 3 FREQ

OSC 1 FREQ OSC 2 FREQ OSC 3 FREQ

**VOLTAGE CONTROLLED FILTER**

18 TRACK

2/3

700 1 1.5

400 2 3

100 3 6

10 4 12

1000 5 24

EMPHASIS

CONTOUR AMOUNT

1.4 2 3

800 4 6

200 5 12

20 6 24

2 7 48

0.2 8 96

0.1 9 192

0.05 10 384

0.02 11 768

0.01 12 1536

24MS/SEC 20SEC

24MS/SEC 20SEC

24MS/SEC 20SEC

24MS/SEC 20SEC

UNCONDITIONAL CONTIN

KEYBOARD FOLLOW

RELEASE

1.4 2 3

800 4 6

200 5 12

20 6 24

2 7 48

0.2 8 96

0.1 9 192

0.05 10 384

0.02 11 768

0.01 12 1536

24MS/SEC 20SEC

24MS/SEC 20SEC

24MS/SEC 20SEC

24MS/SEC 20SEC

RETURN TO ZERO

UNCONDITIONAL CONTIN

KEYBOARD FOLLOW

RELEASE

1.4 2 3

800 4 6

200 5 12

20 6 24

2 7 48

0.2 8 96

0.1 9 192

0.05 10 384

0.02 11 768

0.01 12 1536

24MS/SEC 20SEC

24MS/SEC 20SEC

24MS/SEC 20SEC

24MS/SEC 20SEC

ATTACK

10SEC 20SEC

10SEC 20SEC

10SEC 20SEC

10SEC 20SEC

ATTACK

10SEC 20SEC

10SEC 20SEC

10SEC 20SEC

10SEC 20SEC

**OUTPUTS**

PROGRAMMABLE

MASTER VOLUME

0 10

2 5

PROGRAMMABLE

VOLUME

0 10

2 5

HEADPHONE

0 10

2 5

HEADPHONE

0 10

2 5

VOLUME

Permission is given to copy the above sound charts for non-commercial purposes.

