

AC-2 Acoustic Simulator

Owner's Manual

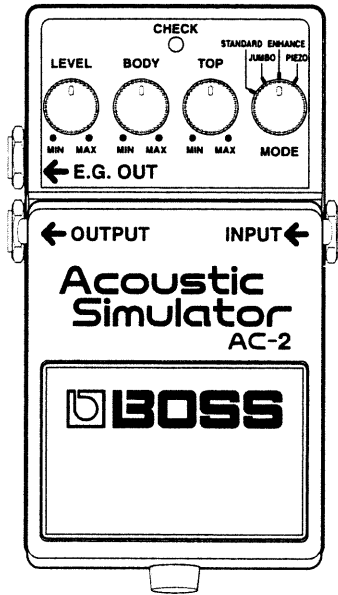

AC & BATTERY
POWERED



 **BOSS**

Thank you, and congratulations on your choice of BOSS AC-2 Acoustic Simulator.

Before using this unit, carefully read the sections entitled: "USING THE UNIT SAFELY" and "IMPORTANT NOTES" (p.20; p.4). These sections provide important information concerning the proper operation of the unit. Additionally, in order to feel assured that you have gained a good grasp of every feature provided by your new unit, this manual should be read in its entirety. The manual should be saved and kept on hand as a convenient reference.

Copyright © 1997 BOSS CORPORATION

All rights reserved. No part of this publication may be reproduced in any form without the written permission of BOSS CORPORATION.

2

FEATURES

- This is an effect unit that transforms an electric guitar sound into an acoustic sound.
- Any of the four different sounds can be selected by changing the position of the Mode switch.
- You can output the acoustic sound and electric guitar sound separately.
- Using the "Body" and "Top" tone control knobs, you can simulate a broad variety of acoustic guitar sounds.

IMPORTANT NOTES

In addition to the items listed under “USING THE UNIT SAFELY” on page 20, please read and observe the following:

Power Supply

- Do not use this unit on the same power circuit with any device that will generate line noise (such as an electric motor or variable lighting system).
- The AC adaptor will begin to generate heat after long hours of consecutive use. This is normal, and is not a cause for concern.
- Batteries should always be installed or replaced before connecting any other devices. This way, you can prevent malfunction and/or damage to speakers or other devices.
- A battery was installed in the unit before it left the factory. The life of this battery may be limited, however, since its primary purpose was to enable testing.

4

- Before connecting this unit to other devices, turn off the power to all units. This will help prevent malfunctions and/or damage to speakers or other devices.

Placement

- Using the unit near power amplifiers (or other equipment containing large power transformers) may induce hum. To alleviate the problem, change the orientation of this unit; or move it farther away from the source of interference.
- Do not expose the unit to direct sunlight, place it near devices that radiate heat, leave it inside an enclosed vehicle, or otherwise subject it to temperature extremes. Excessive heat can deform or discolor the unit.

Maintenance

- For everyday cleaning wipe the unit with a soft, dry cloth or one that has been slightly dampened with water. To remove stubborn dirt, use a cloth impregnated with a mild, non-abrasive detergent. Afterwards, be sure to wipe the unit thoroughly with a soft, dry cloth.
- Never use benzene, thinners, alcohol or solvents of any kind, to avoid the possibility of discoloration and/or deformation.

Additional Precautions

- Use a reasonable amount of care when using the unit's buttons, sliders, or other controls; and when using its jacks and connectors. Rough handling can lead to malfunctions.
- When connecting / disconnecting all cables, grasp the connector itself—never pull on the cable. This way you will avoid causing shorts, or damage to the cable's internal elements.
- To avoid disturbing your neighbors, try to keep the unit's volume at reasonable levels. You may prefer to use headphones, so you do not need to be concerned about those around you (especially when it is late at night).
- When you need to transport the unit, package it in the box (including padding) that it came in, if possible. Otherwise, you will need to use equivalent packaging materials.

PANEL DESCRIPTIONS

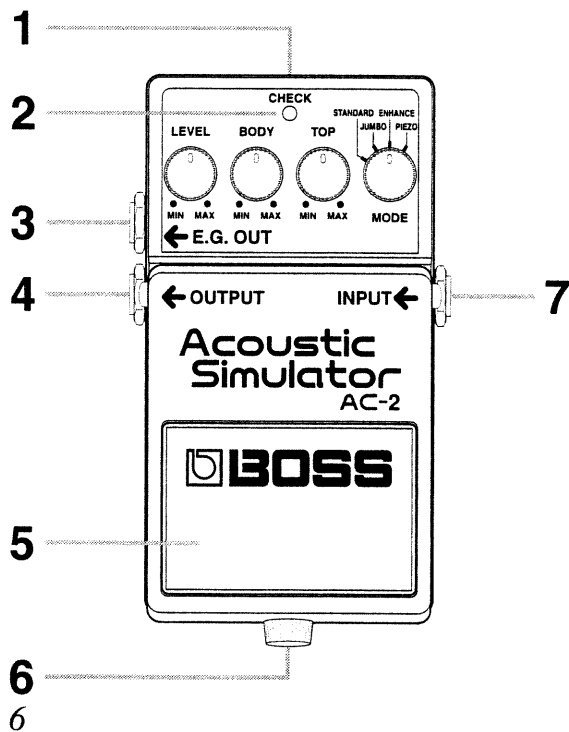

1. AC Adaptor Jack

Accepts connection of an AC Adaptor (optionally available BOSS PSA-Series). By using an AC Adaptor, you can play without being concerned about how much battery power you have left.

** If there are batteries in the unit while an AC adaptor is being used, normal operation will continue should the line voltage be interrupted (power blackout or power cord disconnection).*

** If you are going to use an AC adaptor, be sure to use the specified unit (BOSS PSA-Series). Use of any other adaptor may result in damage, malfunction or electric shock. Also, if you are not going to be using it for an extended period of time, disconnect the AC adaptor from the AC outlet.*

2. CHECK Indicator

This indicator shows whether an effect is ON/OFF, and also doubles as the Battery Check indicator.

The indicator lights when an effect is ON. If this indicator goes dim or no longer lights while an effect is ON, the battery is near exhaustion and should be replaced immediately.

3. E.G. OUT Jack

This is an output jack that should be connected to an amplifier or a different effect unit. It can be effectively used to output the effect and the direct sound separately. When the effect is turned on, this jack is muted, and it outputs the direct sound when the effect is off. For a detailed explanation about this jack, see "MAKING THE CONNECTIONS" on page 12.

4. OUTPUT Jack

Provides the output from the unit—should be connected to an amplifier or some other effect unit.

When there is only one output, connect the amplifier or the effect unit to this jack, and the effect or direct sound will be output depending on whether the effect is on or off.

When a cable is connected to the E.G. Output jack, the Output jack will send an effect sound in the effect mode (when the effect is turned on) and it will be muted in the direct mode (when the effect is turned off). For a detailed explanation, see "MAKING THE CONNECTIONS" on page 12.

5. Pedal Switch

This switch turns the effects ON/OFF.

6. Thumbscrew

This thumbscrew is loosened to open the pedal, allowing battery replacement. For instructions on how to replace the battery, please refer to "CHANGING THE BATTERY (p.16)."

7. INPUT Jack

This jack accepts input signals (coming from a guitar, some other musical instrument, or another effects unit).

** The INPUT jack also serves as the power switch. Power is turned on whenever a plug is inserted into the INPUT jack, and is turned off when the plug is disconnected. When not using the unit, you should disconnect any cord connected to the INPUT jack.*

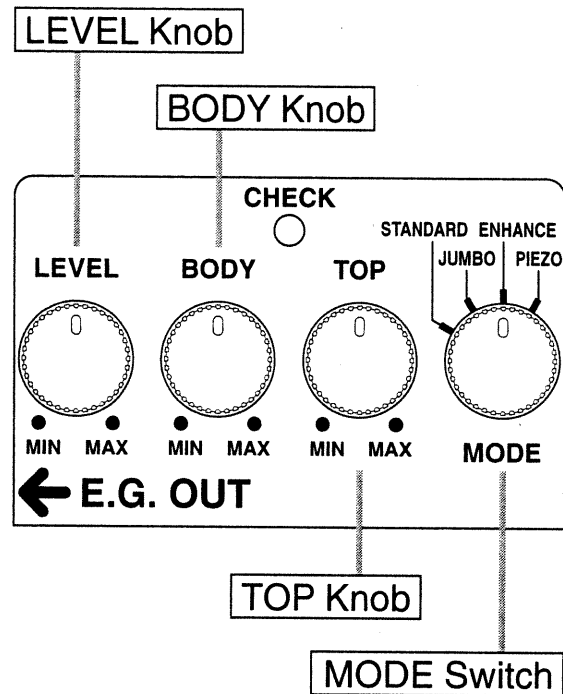

8

LEVEL Knob

This knob adjusts the level of the effect sounds.

BODY Knob

This adjusts the resonance of the sound caused by the body, controlling the softness and fatness of an acoustic guitar.

TOP Knob

This adjusts the treble, controlling the attack and harmonic contents.

MODE Switch

This selects one of the four types of sounds.

** When you change the position of the Mode switch, be sure that the Level knob is rotated fully counterclockwise.*

STANDARD

This is a normal acoustic guitar.

JUMBO

This is an acoustic guitar with a body that is bigger than STANDARD. The bass sound is powerful.

ENHANCE

This is an acoustic guitar that with a more responsive attack, so the guitar will retain more of its prominence in almost any situation.

PIEZO

This simulates the sound you would get from a pickup installed on an electric-acoustic guitar. During the attack, a certain amount of compression will be applied.

9

OPERATING THE UNIT

- 1 When you have made the necessary connections, set the knobs as shown in the illustration.
- 2 Depress the pedalswitch to turn the effect on. (Make sure the CHECK indicator lights.)
- 3 Select a sound with the MODE switch.

** When you change the position of the Mode switch, be sure that the Level knob is rotated fully counterclockwise.*

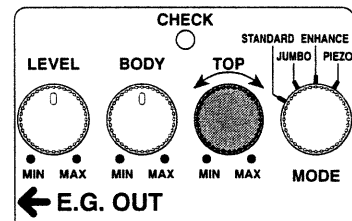
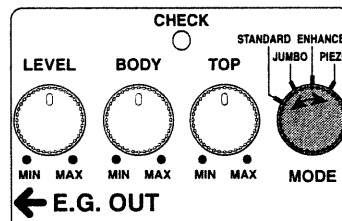
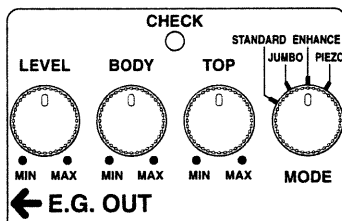

10

- 5 Adjust the fatness of the sound with the BODY knob.
- 6 Adjust the LEVEL knob so that the level of the sound obtained when the effect is on is equal to that obtained when it is off.
- 7 If the higher frequency ranges get distorted, rotate the TOP knob counterclockwise.

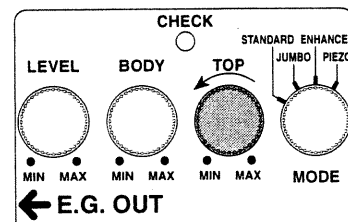
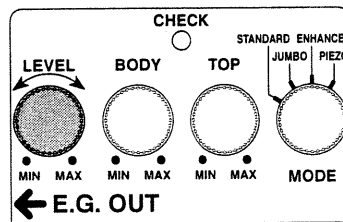
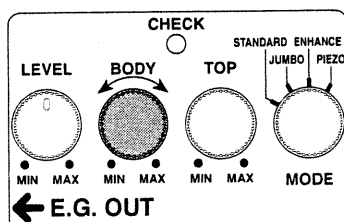

11

MAKING THE CONNECTIONS

- * Inserting a plug into the Input Jack will automatically switch the unit on.
- * Before connecting or disconnecting any patch cords, be sure all the volume controls in your system are set to minimum. This will help prevent any damage to system components.
- * To prevent malfunction and/or damage to speakers or other devices, always turn down the volume, and turn off the power on all devices before making any connections.
- * Always make sure to have the volume level turned down before switching on power. Even with the volume all the way down, you may still hear some sound when the power is switched on, but this is normal, and does not indicate a malfunction.
- * When operating on battery power only, the unit's indicator will become dim when battery power gets too low. Replace the battery as soon as possible.

Connecting the AC-2 to a single amplifier

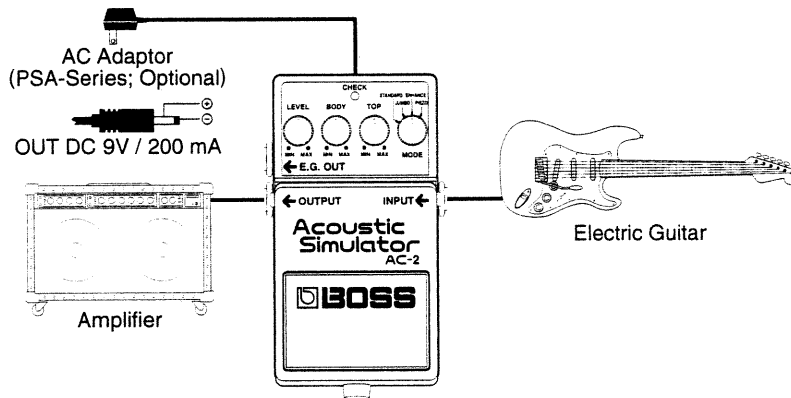

12

Setup for changing the destination of the direct and effect sounds

Connect the units as shown below, and you can change the destinations to which the direct and effect sounds are output.

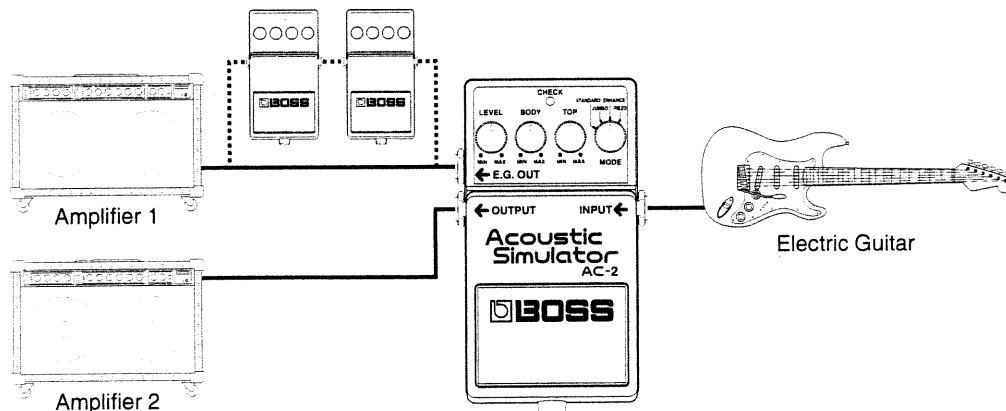

13

When the effect is switched on

The Check indicator lights and amplifier 1 is muted, while the effect sound is output through amplifier 2.

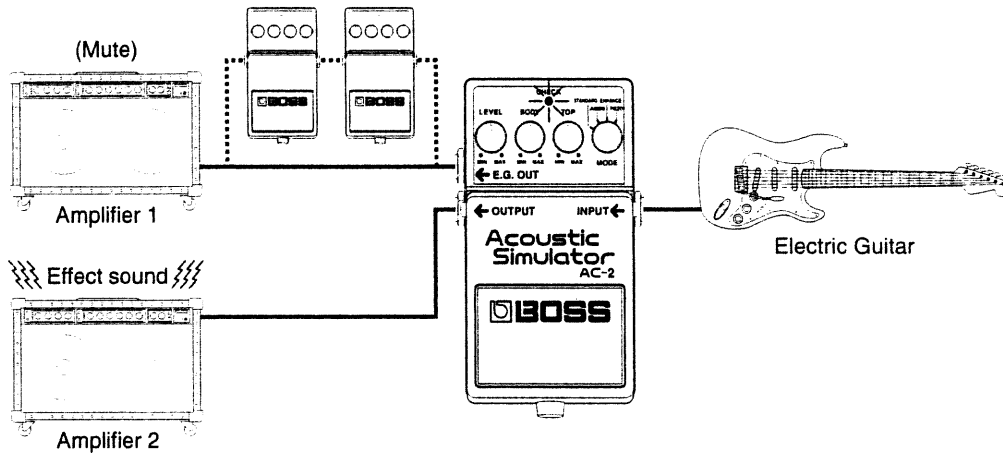

14

When the effect is switched off

The Check indicator remains dark and the guitar's direct sound is output through amplifier 1, while amplifier 2 is muted.

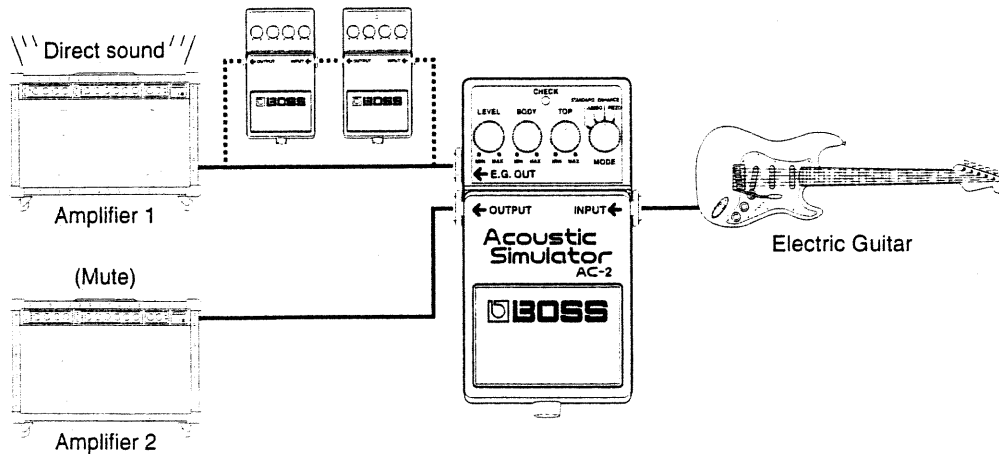

15

CHANGING THE BATTERY

When the indicator goes dim or no longer lights while an effect is on, it means that the battery is nearly dead and must be replaced.

Replace the battery following the steps below.

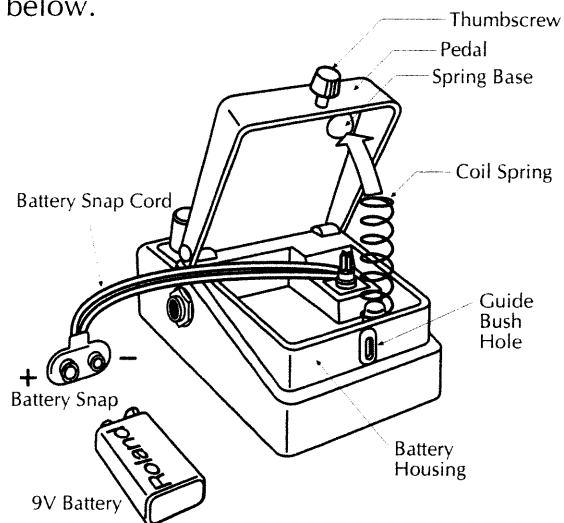

16

- 1 Loosen the thumbscrew at the front of the pedal, then lift the pedal upwards to open the unit.
* **The thumbscrew can be left in the pedal while changing the battery.**
- 2 Remove the old battery from the battery housing, and remove the snap cord connected to it.
- 3 Connect the snap cord to the new battery, and place the battery inside the battery housing.
* **Be sure to carefully observe the battery's polarity (+ versus -).**
- 4 Slip the coil spring onto the spring base on the back of the pedal, then close the pedal.
* **Carefully avoid getting the snap cord caught in the coil spring.**
- 5 Finally, insert the thumbscrew into the guide bush hole and fasten it securely.

SETTING EXAMPLES

Single Coil Pickup
at the Front Position

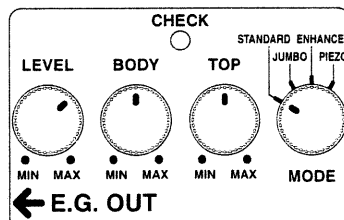

Humbucking Pickup
at the Rear Position

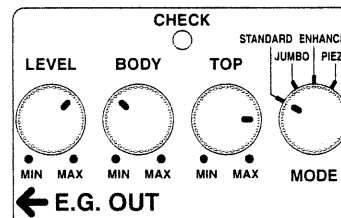

Single Coil Pickup
at the Rear Position

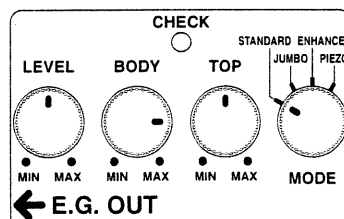

SPECIFICATIONS

AC-2: Acoustic Simulator

Nominal Input Level	-20 dBm
Input Impedance	1 M Ω
Nominal Output Level	-20 dBm
Output Impedance	1 k Ω
Residual Noise Level	-80 dBm (IHF-A Weighted, Typ.) (BODY Knob: Center, TOP Knob: Center)
Controls	Pedal Switch, MODE Switch, BODY Knob, TOP Knob, LEVEL Knob
Indicator	CHECK Indicator (Serves also as battery check indicator)
Connectors	INPUT Jack, E.G.OUT Jack, OUTPUT Jack, AC Adaptor Jack (DC 9 V)
Power Supply	DC 9 V: Dry Battery (6F22/9 V), AC Adaptor (PSA Series: Optional)
Current Draw	18 mA (DC 9 V)
	* Expected battery life under continuous use: Carbon: 14 hours These figures will vary depending on the actual conditions of use.

18

Dimensions	70 (W) x 125 (D) x 55 (H) mm 2-3/4 (W) x 4-15/16 (D) x 2-3/16 (H) inches
Weight	440 g/ 1 lb (including battery)
Accessories	Owner's Manual, Dry Battery; 6F22/ 9 V (Carbon)
Options	AC Adaptor PSA-Series

*** 0 dBm = 0.775 Vrms**

*** In the interest of product improvement, the specifications and/or appearance of this unit are subject to change without prior notice.**



USING THE UNIT SAFELY

INSTRUCTIONS FOR THE PREVENTION OF FIRE, ELECTRIC SHOCK, OR INJURY TO PERSONS

About ⚠ WARNING and ⚠ CAUTION Notices

⚠ WARNING	Used for instructions intended to alert the user to the risk of death or severe injury should the unit be used improperly.
⚠ CAUTION	Used for instructions intended to alert the user to the risk of injury or material damage should the unit be used improperly. * Material damage refers to damage or other adverse effects caused with respect to the home and all its furnishings, as well to domestic animals or pets.

About the Symbols

	The ⚠ symbol alerts the user to important instructions or warnings. The specific meaning of the symbol is determined by the design contained within the triangle. In the case of the symbol at left, it is used for general cautions, warnings, or alerts to danger.
	The ⚡ symbol alerts the user to items that must never be carried out (are forbidden). The specific thing that must not be done is indicated by the design contained within the circle. In the case of the symbol at left, it means that the unit must never be disassembled.
	The ⏻ symbol alerts the user to things that must be carried out. The specific thing that must be done is indicated by the design contained within the circle. In the case of the symbol at left, it means that the power-cord plug must be unplugged from the outlet.

----- **ALWAYS OBSERVE THE FOLLOWING** -----

20

⚠ WARNING

- Before using this unit, make sure to read the instructions below, and the Owner's Manual. 

- Do not open (or modify in any way) the unit or its AC adaptor. 

- Do not attempt to repair the unit, or replace parts within it (except when this manual provides specific instructions directing you to do so). Refer all servicing to your dealer, or qualified Roland service personnel. 

- Never use or store the unit in places that are: 
 - Subject to temperature extremes (e.g., direct sunlight in an enclosed vehicle, near a heating duct, on top of heat-generating equipment); or are
 - Damp (e.g., baths, washrooms, on wet floors); or are
 - Humid; or are
 - Dusty; or are
 - Subject to high levels of vibration.

- Make sure you always have the unit placed so it is level and sure to remain stable. Never place it on stands that could wobble, or on inclined surfaces. 

- Use only the specified AC adaptor (PSA-Series), and make sure the line voltage at the installation matches the input voltage specified on the AC adaptor's body. Other AC adaptors may use a different polarity, or be designed for a different voltage, so their use could result in damage, malfunction, or electric shock. 

- Avoid damaging the power cord. Do not bend it excessively, step on it, place heavy objects on it, etc. A damaged cord can easily become a shock or fire hazard. Never use a power cord after it has been damaged. 

- This unit, either alone or in combination with an amplifier and headphones or speakers, may be capable of producing sound levels that could cause permanent hearing loss. Do not operate for a long period of time at a high volume level, or at a level that is uncomfortable. If you experience any hearing loss or ringing in the ears, you should immediately stop using the unit, and consult an audiologist. 

- Do not allow any objects (e.g., flammable material, coins, pins); or liquids of any kind (water, soft drinks, etc.) to penetrate the unit. 

22

- Immediately turn the power off, remove the AC adaptor from the outlet, and request servicing by your dealer or qualified Roland service personnel when:
 - The AC adaptor or the power-supply cord has been damaged; or
 - Objects have fallen into, or liquid has been spilled onto the unit; or
 - The unit has been exposed to rain (or otherwise has become wet); or
 - The unit does not appear to operate normally or exhibits a marked change in performance.

- In households with small children, an adult should provide supervision until the child is capable of following all the rules essential for the safe operation of the unit. 

- Protect the unit from strong impact. (Do not drop it!) 

- Do not force the unit's power-supply cord to share an outlet with an unreasonable number of other devices. Be especially careful when using extension cords—the total power used by all devices you have connected to the extension cord's outlet must never exceed the power rating (watts/ amperes) for the extension cord. Excessive loads can cause the insulation on the cord to heat up and eventually melt through. 

- Before using the unit in a foreign country, consult with your dealer, or qualified Roland service personnel. 

- Batteries must never be recharged, heated, taken apart, or thrown into fire or water. 
-

 **CAUTION**

- The unit and the AC adaptor should be located so their location or position does not interfere with their proper ventilation. 
-

- Always grasp only the plug or the body of the AC adaptor when plugging into, or unplugging from, an outlet or this unit. 
-

- Whenever the unit is to remain unused for an extended period of time, disconnect the AC adaptor. 
-

- Try to prevent cords and cables from becoming entangled. Also, all cords and cables should be placed so they are out of the reach of children. 
-

- Never climb on top of, nor place heavy objects on the unit. 
-

- Never handle the AC adaptor body, or its plugs, with wet hands when plugging into, or unplugging from, an outlet or this unit. 
-

- Before moving the unit, disconnect the AC adaptor and all cords coming from external devices. 
-

- Before cleaning the unit, turn off the power and unplug the AC adaptor from the outlet (p.12). 
-

- Whenever you suspect the possibility of lightning in your area, disconnect the AC adaptor from the outlet. 
-

- If used improperly, batteries may explode or leak and cause damage or injury. In the interest of safety, please read and observe the following precautions (p.16).



- Carefully follow the installation instructions for batteries, and make sure you observe the correct polarity.
- Remove the batteries whenever the unit is to remain unused for an extended period of time.
- If a battery has leaked, use a soft piece of cloth or paper towel to wipe all remnants of the discharge from the battery compartment. Then install new batteries. If any of the discharge from the battery has gotten onto your hands or skin, make sure to wash the area thoroughly with water.
- Never keep batteries together with metallic objects such as ballpoint pens, necklaces, hairpins, etc.

- Used batteries must be disposed of in compliance with whatever regulations for their safe disposal that may be observed in the region in which you live.



26



This product complies with the requirements of European Directive 89/336/EEC.

For Europe

 **BOSS**

Printed in Taiwan '97-1-D3-11C

 Roland®

G6017261

UPC

06017261



10981

 **BOSS**