

BR-900CD DIGITAL RECORDING STUDIO

Owner's Manual

Thank you, and congratulations on your choice of the BOSS BR-900CD Digital Recording Studio.

Before using this unit, carefully read the sections entitled:

- **USING THE UNIT SAFELY** (page 2–3)
- **IMPORTANT NOTES** (page 4–5)

These sections provide important information concerning the proper operation of the unit.

Additionally, in order to feel assured that you have gained a good grasp of every feature provided by your new unit, Owner's manual should be read in its entirety. The manual should be saved and kept on hand as a convenient reference.

■ Printing Conventions in This Manual

- Text or numerals enclosed in square brackets [] indicate buttons.
 [PLAY] PLAY button
 [REC] REC button
- Reference such as (p. **) indicate pages in this manual to which you can refer.

Copyright © 2005 BOSS CORPORATION

All rights reserved. No part of this publication may be reproduced in any form without the written permission of BOSS CORPORATION.

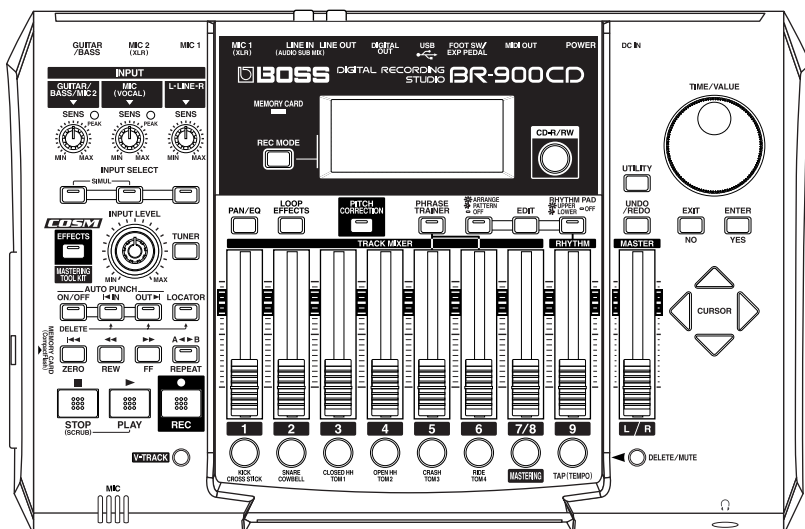

USING THE UNIT SAFELY

INSTRUCTIONS FOR THE PREVENTION OF FIRE, ELECTRIC SHOCK, OR INJURY TO PERSONS

About ⚠ WARNING and ⚠ CAUTION Notices

⚠ WARNING	Used for instructions intended to alert the user to the risk of death or severe injury should the unit be used improperly.
⚠ CAUTION	Used for instructions intended to alert the user to the risk of injury or material damage should the unit be used improperly. * Material damage refers to damage or other adverse effects caused with respect to the home and all its furnishings, as well to domestic animals or pets.

About the Symbols

	The ⚠ symbol alerts the user to important instructions or warnings. The specific meaning of the symbol is determined by the design contained within the triangle. In the case of the symbol at left, it is used for general cautions, warnings, or alerts to danger.
	The ⓧ symbol alerts the user to items that must never be carried out (are forbidden). The specific thing that must not be done is indicated by the design contained within the circle. In the case of the symbol at left, it means that the unit must never be disassembled.
	The ● symbol alerts the user to things that must be carried out. The specific thing that must be done is indicated by the design contained within the circle. In the case of the symbol at left, it means that the power-cord plug must be unplugged from the outlet.

ALWAYS OBSERVE THE FOLLOWING







⚠ WARNING

- Before using this unit, make sure to read the instructions below, and the Owner's Manual.
- Do not open (or modify in any way) the unit or its AC adaptor.
- Do not attempt to repair the unit, or replace parts within it (except when this manual provides specific instructions directing you to do so). Refer all servicing to your retailer, the nearest Roland Service Center, or an authorized Roland distributor, as listed on the "Information" sheet.
- Never use or store the unit in places that are:
 - Subject to temperature extremes (e.g., direct sunlight in an enclosed vehicle, near a heating duct, on top of heat-generating equipment); or are
 - Damp (e.g., baths, washrooms, on wet floors); or are
 - Humid; or are
 - Exposed to rain; or are
 - Dusty; or are
 - Subject to high levels of vibration.
- Make sure you always have the unit placed so it is level and sure to remain stable. Never place it on stands that could wobble, or on inclined surfaces.
- Be sure to use only the AC adaptor supplied with the unit. Also, make sure the line voltage at the installation matches the input voltage specified on the AC adaptor's body. Other AC adaptors may use a different polarity, or be designed for a different voltage, so their use could result in damage, malfunction, or electric shock.





⚠ WARNING

- Do not excessively twist or bend the power cord, nor place heavy objects on it. Doing so can damage the cord, producing severed elements and short circuits. Damaged cords are fire and shock hazards!
- This unit, either alone or in combination with an amplifier and headphones or speakers, may be capable of producing sound levels that could cause permanent hearing loss. Do not operate for a long period of time at a high volume level, or at a level that is uncomfortable. If you experience any hearing loss or ringing in the ears, you should immediately stop using the unit, and consult an audiologist.
- Do not allow any objects (e.g., flammable material, coins, pins); or liquids of any kind (water, soft drinks, etc.) to penetrate the unit.
- Immediately turn the power off, remove the AC adaptor from the outlet, and request servicing by your retailer, the nearest Roland Service Center, or an authorized Roland distributor, as listed on the "Information" sheet when:
 - The AC adaptor or the power-supply cord has been damaged; or
 - If smoke or unusual odor occurs
 - Objects have fallen into, or liquid has been spilled onto the unit; or
 - The unit has been exposed to rain (or otherwise has become wet); or
 - The unit does not appear to operate normally or exhibits a marked change in performance.











⚠ WARNING

- In households with small children, an adult should provide supervision until the child is capable of following all the rules essential for the safe operation of the unit. 
- Protect the unit from strong impact. (Do not drop it!) 
- Do not force the unit's power-supply cord to share an outlet with an unreasonable number of other devices. Be especially careful when using extension cords—the total power used by all devices you have connected to the extension cord's outlet must never exceed the power rating (watts/amperes) for the extension cord. Excessive loads can cause the insulation on the cord to heat up and eventually melt through. 
- Before using the unit in a foreign country, consult with your retailer, the nearest Roland Service Center, or an authorized Roland distributor, as listed on the "Information" sheet. 
- Batteries must never be recharged, heated, taken apart, or thrown into fire or water. 

- DO NOT play a CD-ROM disc on a conventional audio CD player. The resulting sound may be of a level that could cause permanent hearing loss. Damage to speakers or other system components may result. 

⚠ CAUTION

- The unit and the AC adaptor should be located so their location or position does not interfere with their proper ventilation. 
- Always grasp only the output plug or the body of the AC adaptor when plugging into, or unplugging from, this unit or an outlet. 
- Any accumulation of dust between the AC adaptor and the power outlet can result in poor insulation and lead to fire. Periodically wipe away such dust with a dry cloth. Also, disconnect the power plug from the power outlet whenever the unit is to remain unused for an extended period of time. 
- Try to prevent cords and cables from becoming entangled. Also, all cords and cables should be placed so they are out of the reach of children. 
- Never climb on top of, nor place heavy objects on the unit. 

⚠ CAUTION

- Never handle the AC adaptor body, or its output plugs, with wet hands when plugging into, or unplugging from, an outlet or this unit. 
- Before moving the unit, disconnect the AC adaptor and all cords coming from external devices. 
- Before cleaning the unit, turn off the power and unplug the AC adaptor from the outlet. 
- Whenever you suspect the possibility of lightning in your area, disconnect the AC adaptor from the outlet. 
- If used improperly, batteries may explode or leak and cause damage or injury. In the interest of safety, please read and observe the following precautions (p. 23). 
 - Carefully follow the installation instructions for batteries, and make sure you observe the correct polarity. 
 - Avoid using new batteries together with used ones. In addition, avoid mixing different types of batteries. 
 - Remove the batteries whenever the unit is to remain unused for an extended period of time.
 - If a battery has leaked, use a soft piece of cloth or paper towel to wipe all remnants of the discharge from the battery compartment. Then install new batteries. To avoid inflammation of the skin, make sure that none of the battery discharge gets onto your hands or skin. Exercise the utmost caution so that none of the discharge gets near your eyes. Immediately rinse the affected area with running water if any of the discharge has entered the eyes.
- Never keep batteries together with metallic objects such as ballpoint pens, necklaces, hairpins, etc.
- Used batteries must be disposed of in compliance with whatever regulations for their safe disposal that may be observed in the region in which you live. 
- Should you remove screws, keep them in a safe place out of children's reach, so there is no chance of them being swallowed accidentally. 
- Always turn the phantom power off when connecting any device other than condenser microphones that require phantom power. You risk causing damage if you mistakenly supply phantom power to dynamic microphones, audio playback devices, or other devices that don't require such power. Be sure to check the specifications of any microphone you intend to use by referring to the manual that came with it. (This instrument's phantom power: +48 V DC, 7 mA Max) 

IMPORTANT NOTES

In addition to the items listed under “USING THE UNIT SAFELY” on page 2–3, please read and observe the following:

Power Supply: Use of Batteries

- Do not use this unit on the same power circuit with any device that will generate line noise (such as an electric motor or variable lighting system).
- The AC adaptor will begin to generate heat after long hours of consecutive use. This is normal, and is not a cause for concern.
- The use of an AC adaptor is recommended as the unit’s power consumption is relatively high. Should you prefer to use batteries, please use the alkaline type.
- When installing or replacing batteries, always turn off the power on this unit and disconnect any other devices you may have connected. This way, you can prevent malfunction and/or damage to speakers or other devices.
- Before connecting this unit to other devices, turn off the power to all units. This will help prevent malfunctions and/or damage to speakers or other devices.

Placement

- Using the unit near power amplifiers (or other equipment containing large power transformers) may induce hum. To alleviate the problem, change the orientation of this unit; or move it farther away from the source of interference.
- This device may interfere with radio and television reception. Do not use this device in the vicinity of such receivers.
- Noise may be produced if wireless communications devices, such as cell phones, are operated in the vicinity of this unit. Such noise could occur when receiving or initiating a call, or while conversing. Should you experience such problems, you should relocate such wireless devices so they are at a greater distance from this unit, or switch them off.
- Do not expose the unit to direct sunlight, place it near devices that radiate heat, leave it inside an enclosed vehicle, or otherwise subject it to temperature extremes. Excessive heat can deform or discolor the unit.
- When moved from one location to another where the temperature and/or humidity is very different, water droplets (condensation) may form inside the unit. Damage or malfunction may result if you attempt to use the unit in this condition. Therefore, before using the unit, you must allow it to stand for several hours, until the condensation has completely evaporated.

Maintenance

- For everyday cleaning wipe the unit with a soft, dry cloth or one that has been slightly dampened with water. To remove stubborn dirt, use a cloth impregnated with a mild, non-abrasive detergent. Afterwards, be sure to wipe the unit thoroughly with a soft, dry cloth.
- Never use benzine, thinners, alcohol or solvents of any kind, to avoid the possibility of discoloration and/or deformation.

Repairs and Data

- Please be aware that all data contained in the unit’s memory may be lost when the unit is sent for repairs. Important data should always be backed up on a memory card/computer, or written down on paper (when possible). During repairs, due care is taken to avoid the loss of data. However, in certain cases (such as when circuitry related to memory itself is out of order), we regret that it may not be possible to restore the data, and Roland assumes no liability concerning such loss of data.

Additional Precautions

- Please be aware that the contents of memory can be irretrievably lost as a result of a malfunction, or the improper operation of the unit. To protect yourself against the risk of losing important data, we recommend that you periodically save a backup copy of important data you have stored in the unit’s memory on a memory card / computer.
- Unfortunately, it may be impossible to restore the contents of data that was stored in the unit’s memory or a memory card once it has been lost. Roland Corporation assumes no liability concerning such loss of data.
- Use a reasonable amount of care when using the unit’s buttons, sliders, or other controls; and when using its jacks and connectors. Rough handling can lead to malfunctions.
- Never strike or apply strong pressure to the display.
- When connecting / disconnecting all cables, grasp the connector itself—never pull on the cable. This way you will avoid causing shorts, or damage to the cable’s internal elements.
- To avoid disturbing your neighbors, try to keep the unit’s volume at reasonable levels. You may prefer to use headphones, so you do not need to be concerned about those around you (especially when it is late at night).
- When you need to transport the unit, package it in the box (including padding) that it came in, if possible. Otherwise, you will need to use equivalent packaging materials.
- Use only the specified expression pedal (Roland EV-5 or BOSS FV-300L; sold separately). By connecting any other expression pedals, you risk causing malfunction and/or damage to the unit.
- Use a cable from Roland to make the connection. If using some other make of connection cable, please note the following precautions.
 - Some connection cables contain resistors. Do not use cables that incorporate resistors for connecting to this unit. The use of such cables can cause the sound level to be extremely low, or impossible to hear. For information on cable specifications, contact the manufacturer of the cable.

Handling CD-ROMs

- Avoid touching or scratching the shiny underside (encoded surface) of the disc. Damaged or dirty CD-ROM discs may not be read properly. Keep your discs clean using a commercially available CD cleaner.

Before Using Memory Cards (CompactFlash)

Using Memory Cards

- Carefully insert the Memory card all the way in—until it is firmly in place.

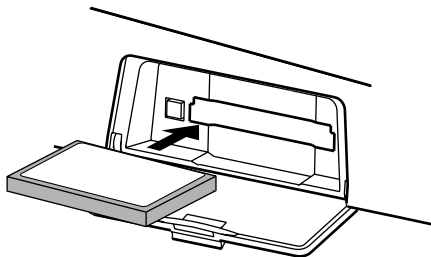

- Never touch the terminals of the Memory card. Also, avoid getting the terminals dirty.
- This unit's memory card slot accepts CompactFlash memory cards. Microdrive storage media by IBM are not compatible.
- CompactFlash cards are constructed using precision components; handle the cards carefully, paying particular note to the following.
 - To prevent damage to the cards from static electricity, be sure to discharge any static electricity from your own body before handling the cards.
 - Do not touch or allow metal to come into contact with the contact portion of the cards.
 - Do not bend, drop, or subject cards to strong shock or vibration.
 - Do not keep cards in direct sunlight, in closed vehicles, or other such locations (storage temperature: -25 to 85° C).
 - Do not allow cards to become wet.
 - Do not disassemble or modify the cards.

Copyright

- Unauthorized recording, distribution, sale, lending, public performance, broadcasting, or the like, in whole or in part, of a work (musical composition, video, broadcast, public performance, or the like) whose copyright is held by a third party is prohibited by law.
- Do not use this unit for purposes that could infringe on a copyright held by a third party. We assume no responsibility whatsoever with regard to any infringements of third-party copyrights arising through your use of this unit.

-
- * Microsoft and Windows are registered trademarks of Microsoft Corporation.
 - * Screen shots in this documents are reprinted with permission from Microsoft Corporation.
 - * Windows® is known officially as: "Microsoft® Windows® operating system."
 - * Apple and Macintosh are registered trademark of Apple Computer, Inc.
 - * MacOS is a trademark of Apple Computer, Inc.
 - * All product names mentioned in this document are trademarks or registered trademarks of their respective owners.

Before Using CD-R/RW Discs

Two different types of recordable disc can be used with the BR-900CD—namely, CD-R discs and CD-RW discs.

What is a CD-R disc?

CD-R (Compact Disc Recordable) is a CD to which data can be written. It is not possible to erase or move the data that has been written.

This type of disc should be used to create audio CDs that will be played on standard CD players. Playback of CD-RW discs will not be possible on this type of equipment. In addition, even if you have created an audio CD using a CD-R disc, playback will only be possible on players that support the playback of recordable discs.

What is a CD-RW disc?

CD-RW (Compact Disc ReWritable) is a CD that can be written and erased. As a result, this type of recordable disc can be used again and again.

While you can create audio CDs using CD-RW discs, it will not be possible to play these CDs on a standard CD player. (You will, however, be able to play these discs using the BR-900CD's CD-R/RW drive.)

Handling the CD-R/RW disc drive



When you use the CD-R/RW drive, you must use only the supplied AC adaptor.

The CD-R/RW drive cannot be used while running on battery power.

- Install the unit on a solid, level surface in an area free from vibration. If the unit must be installed at an angle, be sure the installation does not exceed the permissible range.
- Avoid using the unit immediately after it has been moved to a location with a level of humidity that is greatly different than its former location. Rapid changes in the environment can cause condensation to form inside the drive, which will adversely affect the operation of the drive and/or damage CD-R/RW discs. When the unit has been moved, allow it to become accustomed to the new environment (allow a few hours) before operating it.
- Avoid using the CD-R/RW drive in locations with high temperatures. Failure to observe this precaution can result in the drive becoming unable to operate correctly or in write errors. In addition, this type of environment can also reduce the lifespan of the CD-R/RW drive.
- Remove any disc from the drive before powering up or down.
- To avoid the risk of malfunction and/or damage, insert only CD-R/RW discs into the disc drive. Never insert any other type of disc. Avoid getting paper clips, coins, or any other foreign objects inside the drive.

- Do not touch the lens.
- When the lens is dirty, clean the lens with a commercial lens blower.
- If a write error occurs, carry out cleaning using a commercially available CD-RW drive lens cleaner.
 - * *Note that some commercially available cleaners are intended for CD-R drives, while others are intended for CD-RW drives. Be sure to select a cleaner for CD-RW drives.*
 - * *Never use commercially available cleaner intended for standard CD players. This type of cleaner cannot be used to clean the BR-900CD's write lens.*
 - * *Even if the recommended type of CD-R/RW disc is used in a perfectly normal CD-R/RW drive, the possibility of write errors cannot be completely eliminated. Please be aware that this type of problem can still occur as a result of variations in CD-R/RW drives and CD-R/RW disc manufacturing differences.*

Handling CD-R/RW discs

- * *In addition to the following precautions, please also read the instructions provided with the CD-R/RW discs.*
- DO NOT play a CD-R/RW disc (CD-R/RW disc on which song data has been backed up) on a conventional audio CD player. The resulting sound may be of a level that could cause permanent hearing loss. Damage to speakers or other system components may result.
- Upon handling the discs, please observe the following.
 - Do not touch the recorded surface of the disc.
 - Do not use in dusty areas.
 - Do not leave the disc in direct sunlight or an enclosed vehicle.
- Keep the disc in the case.

Compatibility of CD-R/RW discs and drives

- Ensure that the recommended type of CD-R/RW discs are always used. Failure to observe this precaution can lead to an increase in the frequency of write errors.
- Even when the recommended type of disc is used, there is still a possibility that write errors can occur. Please be aware that this type of problem can still result from variations in CD-R/RW drives and CD-R/RW disc manufacturing differences.
- The usage of discs with printable labels is not recommended, even if these discs are of the recommended type. Certain storage conditions can cause discs with printable labels to warp, and write errors can occur as a result.

When you insert a CD-R/RW disc to built in CD-R/RW drive...

When you insert a CD-R/RW disc to built in CD-R/RW drive, lock the CD-R/RW disc at correct position according to “Insert a CD-R/RW disc” below. Please be careful to lock a CD-R/RW disc correctly. Unless, it is possible that the disc tray is stuck and unable to remove a CD-R/RW disc.

Inserting a CD-R/RW disc

1. Press the eject button and open a disc tray.
2. Pull out a disc tray.
3. Locate the position of center hole of CD-R/RW disc at stopper of CD-R/RW drive.
4. Press the CD-R/RW disc downward. The CD-R/RW disc will be locked by 3 clips of the stopper.

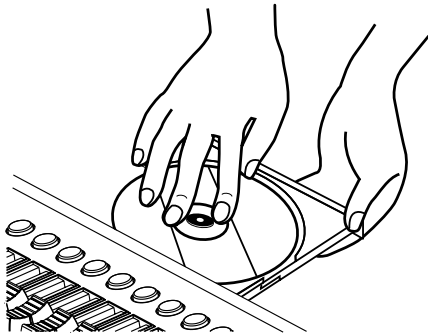

* As a certain amount of force must be applied for insertion, always confirm that the CD-R/RW disc has been correctly inserted. Failure to properly and fully insert a disc can result in an inability to carry out writing correctly.

5. Press disc tray until it is locked in the BR-900CD.

Removing a CD-R/RW disc

1. Hold the stopper downward and remove a CD-R/RW disc from outer rim.

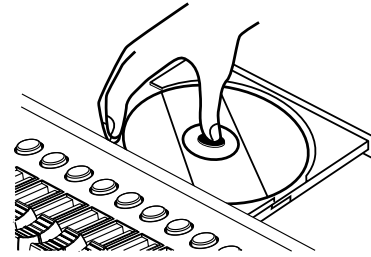

NOTE

If a disc tray does not open

If the power is turned off with the disc still in the drive (such as due to a power failure), the disc tray cannot be opened by pressing the eject button. In this case, you can insert a piece of wire to force the tray open.

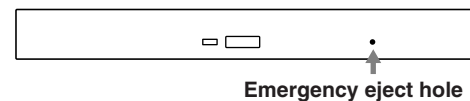

Make sure the BR-900CD's power has been turned OFF before attempting to use the emergency eject hole. If you insert something while the power is on, the disc could get damaged, or unexpected problems may occur.

Notes When Using Mics

Always be sure to switch the phantom power off except when connecting condenser mics requiring a phantom power supply. Supplying phantom power to dynamic mics, audio playback equipment, and other devices that do not use phantom power may cause damage to your equipment.

For mic specifications, please refer to the owner's manual for whatever model of mic you are using.

* BR-900CD Phantom Power: +48 V DC, 7 mA Max.

Phantom power is supplied to the XLR connectors for MIC 1 and MIC 2 simultaneously. The phantom power cannot be switched on or off for each connector individually.

If simultaneously using mics that require phantom power with those that don't, then connect any mic that does not need phantom power to one of the 1/4" phone jacks. Phantom power is supplied only to the XLR connectors, not to the 1/4" phone jacks.

To connect mics to the 1/4" phone jacks, use a commercially available XLR-to-phone adapter cable or other form of adapter.

Contents

USING THE UNIT SAFELY	2
IMPORTANT NOTES	4
Before Using CD-R/RW Discs	6
Notes When Using Mics	7
Introduction to the BR-900CD.....	14
Features	14
Memory Cards Supported by Your BR-900CD.....	16
How to remove the card protector	16
Panel Descriptions	17
Front Panel.....	17
Rear Panel.....	22
Inserting Batteries.....	23
Quick Start	25
Connecting Peripheral Devices	26
Inserting a Memory Card	27
Turning On / Off the BR-900CD	28
Turning On the Power	28
Turning Off the Power.....	28
Listening to a Demo Song	29
Selecting a song (Song Select)	29
Playing back a song	29
Changing the current position	30
Recording/Playing Back a Song	31
(1) Preparing the Memory Card	31
(2) Turning On the Power	31
Formatting the memory card (Initialize).....	31
(3) Selecting the Song to Record.....	32
Recording a new song (Song New)	32
(4) Connecting Instruments	33
Choose which jack you will use to connect your instrument.....	33
Press the INPUT SELECT button of the instrument that you want to record	34
Turning on the internal microphone.....	34
Adjusting the input sensitivity	35
Adjusting the input level	35
(5) Using Insert Effects	35
Switch effect patches	35
Recording without insert effects.....	36
(6) Using the Rhythm	37
Playing the Rhythm	37
Changing arrangements.....	37
Changing patterns	38
Changing the tempo of the arrangements or patterns	38
Tapping to change the tempo of the arrangements or patterns.....	38
(7) Basic Recording	39
Selecting the recording track	39
About the recording (REC) modes	39
Procedure	40
(8) Playing Back Recorded Music.....	41
Silencing the sound of specific tracks (Track Mute)	41
(9) Overdubbing (Recording an additional performance while listening to an existing performance)	41
(10) Adjusting the Sound for Each Track	42
Setting the positioning (pan) of the sound.....	42
Adjusting the tone (Track EQ)	43
Adding width to the sound (Loop Effect)	43
(11) Bouncing (Putting multiple tracks together)	45
(12) Turning Off the Power	45
(13) Removing the Memory Card.....	45

Section 1 Recording and Playback.. 47

Recording.....48

- Selecting the Recording Track 48
- Changing V-Tracks.....49
- Changing the Position of the Input Sound (Pan).....49
- Recording Operations.....50

Repeating Playback (Repeat).....51

- Setting the Repeat Portion.....51
- Setting the Repeat Portion with Accurate Timing.....52

Re-recording Only a Mistake (Punch-in/out)53

- Manually Punching In/Out.....53
 - Manually punching in and out using [REC]53
 - Manually punching in and out using a foot switch.....54
- Auto Punching In and Out.....54
 - Specifying the area for auto punching in/out54
 - Erasing a registered auto punch in/out location 55
 - How to record55
- Repeatedly Recording Over the Same Location (Loop Recording).....56
 - Setting the portion to be repeated56
 - How to record56

Canceling an Operation (Undo/Redo) ... 57

- Reversing the Last Operation (Undo)57
- Canceling the Undo (Redo).....57

Putting Multiple Tracks Together (Bounce).....58

- Bouncing Directly to a CD-R/RW Disc (Direct CD Bounce)59
- Selecting the Input Source and Bouncing the Recording to a CD-R/RW 60

Loading Songs Created with the BR-864/BR-53261

- Loading Songs Created with the BR-864.....61
- Loading Songs Created with the BR-532.....61

Displaying the Song Information62

- Displaying the Remaining Available Recording Time62
- Displaying the Memory Card Usage.....62

Section 2 Editing63

Registering Time (Locator)64

- Registering a Locator Point64
- Moving to the Locator Point64
- Deleting a Locator Point64

Search for the Music's Start and End (Scrub/Preview)65

- Scrubbing to Find the Music Starting/Ending Point.... 65
- Changing the Scrub Points.....66
- Enabling Use of the Preview Function with [REW] and [FF]66

Editing the Performance on a Track (Track Editing)67

- Copying Data (Track Copy)67
 - Copying the repeated portion (AB).....67
 - Copying by specifying the time (TME/MES)..... 68
 - Copying a complete track (ALL)69
- Moving Data (Track Move).....70
 - Moving the repeated portion (AB)70
 - Moving by specifying the time (TME/MES)..... 71
 - Moving a complete track (ALL).....72
- Erasing Data (Track Erase).....73
 - Erasing the repeated portion (AB).....73
 - Erasing by specifying the time (TME/MES)..... 74
 - Erasing a complete track (ALL)75
- Exchanging Data (Track Exchange).....76

Organizing the Songs You've Recorded.....77

- Copying a Song (Song Copy).....77
- Erasing Songs (Song Erase).....77
- Saving Memory on the Memory Card (Song Optimize).....78
- Naming Songs (Song Name).....78
- Protecting a Song (Song Protect)79
- Saving the Current Settings to the Song (Song Save) 79

Creating a Master Tape / Disc 80

- Recording to a Cassette Tape Recorder (Analog Connection)80
- Recording to a Digital Recorder (Digital Connection)... 80
 - Disabling digital copying (Digital Copy Protect)..... 80

Section 3 Using Effects 83

Using the Insert Effects84

Effect Patches and Banks.....	84
Editing Insert Effect Settings.....	85
Saving Insert Effects Settings (Write)	86
Changing How the Insert Effects are Used According to the Mode	87

Insert Effect Parameter Functions88

Algorithm List.....	88
BANK: GUITAR	88
1. COSM GTR AMP	88
2. ACOUSTIC SIM	88
3. BASS SIM	89
4. COSM COMP GTR	89
5. ACOUSTIC GTR	89
6. BASS MULTI	89
7. COSM BASS AMP	90
8. COSM COMP BSS.....	90
BANK: MIC	90
9. VOCAL MULTI.....	90
10. VOICE TRANS	90
11. COSM COMP VCL	91
BANK: LINE.....	91
12. STEREO MULTI.....	91
13. LO-FI BOX.....	91
BANK: SIMUL	92
14. VO+GT AMP	92
15. VO+AC.SIM.....	92
16. VO+ACOUSTIC	92
Parameter List	93
Acoustic Guitar Simulator	93
Acoustic Processor	93
Bass Simulator	93
Chorus	94
Compressor	94
COSM Comp (compressor)/Limiter.....	94
De-esser	95
Defretter	95
Delay	95
Doubling.....	95
Enhancer.....	95

Equalizer.....	96
Flanger	96
Foot Volume	96
Lo-Fi Box	96
Noise Suppressor	97
Octave	97
Phaser.....	97
Pitch Shifter.....	98
Preamp.....	98
Ring Modulator	99
Slow Attack.....	99
Speaker Simulator	100
Tremolo/Pan	100
Voice Transformer	100
Wah	101

Mastering 102

Editing the Mastering Tool Kit Settings	103
Saving the Mastering Tool Kit Settings (Write).....	104

Mastering Tool Kit Parameter Functions..... 105

Algorithm.....	105
Parameter List	105
Equalizer.....	105
Bass Cut Filter.....	106
Enhancer.....	106
Input.....	106
Expander	106
Compressor.....	107
Mixer	107
Limiter	107
Output	107

Using the Loop Effects/Track EQ ... 108

Selecting the Loop Effect	108
Adjusting How the Loop Effect is Applied	109
Setting the Track EQ.....	110

Loop Effect Parameter Functions ... 111

Parameter List	111
CHORUS/DELAY/DBLN (Doubling).....	111
REVERB.....	111

Track EQ Parameter Functions 112

Parameter List 112

Fixing the Pitch of Vocals (Pitch Correction) 113

The Pitch Correction 113

Makeup of the Pitch Correction 113

Pitch Correction Patches 113

Precautions for Pitch Correction Usage 113

Using the Pitch Correction 114

Setting the Correction Method for Vocal Pitch
(Pitch Correction Edit) 115

Saving the Pitch Correction Settings (Write) 115

Making Detailed Settings for Pitch Correction
(Correction Event Map) 116

Section 4 Using the Rhythm . 119

Using the Rhythm 120

About the Patterns 120

Types of patterns 120

About the Arrangements 120

Types of arrangements 120

Switching the Rhythm Mode 121

Recording Rhythm Performances 121

Performing Arrangements and Patterns 121

Selecting arrangements 121

Performing arrangements 121

Selecting patterns 122

Performing patterns 122

Changing the tempo of the arrangements or
patterns 122

Tapping to change the tempo of the
arrangements or patterns 122

Creating Original Arrangements... 123

Inserting a Step 124

Erasing a Step 124

Naming Arrangements 124

Copying Arrangements 125

Erasing Arrangements 125

Creating Original Patterns 126

Note concerning creation of patterns 126

Creating Patterns in Realtime Recording 126

Rehearsing recordings 128

Deleting unneeded drum sounds 129

Changing the metronome volume 129

Creating Patterns in Step Recording 130

Changing the velocity 132

Deleting unneeded drum sounds 132

Naming Patterns 132

Copying Patterns 133

Erasing Patterns 133

Using the Drum Kits 134

Performing the Drums 134

Selecting Drum Kits 134

Creating Original Drum Kits (Tone Load) 135

Loading from the tracks 135

Copying drum sounds from other drum kits 137

Changing the position (pan) of the drum sounds .. 138

Section 5 Using the CD-R/RW Drive..... 139

Creating Audio CD 140

Precautions	140
Setting the Time Between Songs (Pre-Gap)	140
Writing Songs to Discs	140
Viewing the Remaining Time for Recording on Audio CDs	142
Playing Back Audio CDs	142
Enabling Playback on CD Players (Finalize)	143

Using the CD-R/RW Drive to Exchange Data..... 145

Saving Recorded Songs to CD-R/RW Discs (Backup)	145
Backing up a song to a CD-R/RW disc one at a time (Song Backup).....	145
Saving all of the songs on a memory card to a CD-R/RW disc (All Backup).....	146
Loading Saved Songs to a Memory Card (Recover)	147
Loading saved songs to a memory card one at a time (Song Recover).....	147
Loading all saved songs to a memory card (All Recover)	147
Copying and Writing Waveform Data	148
Copying waveform data from a computer to the audio tracks (WAV/AIFF Import)	148
Copying WAV/AIFF files as drum sounds (Tone Load).....	149
Copying audio track waveform data to computers (WAV/AIFF Export).....	150
Using SMF	151
Playing SMFs using external MIDI instruments (SMF Player)	151
Loading drum patterns from the CD-R/RW drive (SMF Import).....	152
Erasing Data from a CD-RW Disc (CD-RW Erase)....	153

Importing Songs from CDs to Audio Tracks 154

Section 6 Using MIDI 155

MIDI Fundamentals 156

What is MIDI?	156
MIDI Connectors	156
MIDI Channels	156
MIDI Implementation Charts	156

Synchronizing with MIDI Devices .. 157

Using the Rhythm to Play an External MIDI Sound Module	157
Synchronizing Playback with a MIDI Sequencer....	158
Synchronized playback with the BR-900CD as the master	158
Setting the MTC offset.....	159
Using MMC	160
Operating MMC-compatible devices with the BR-900CD	160

Section 7 Using USB 161

Before Using USB (Overview) 162

Compatible OS	162
Composition of Data on Memory Cards	162
Connecting a Computer.....	163
Notes on Using USB	163

With Windows 164

Backing Up the BR-900CD's Data	164
Saving BR-900CD Track Data in WAV/AIFF Format (WAV/AIFF Export)	165
Loading WAV/AIFF Files in BR-900CD Tracks (WAV/AIFF Import).....	167
Importing SMFs and Creating Patterns.....	169
Loading Drum Sounds from WAV/AIFF Files (Tone Load)	171
Using the BR-864 / BR-532's Data.....	173

With Macintosh 175

Backing Up the BR-900CD's Data	175
Saving BR-900CD Track Data in WAV/AIFF Format (WAV/AIFF Export)	176
Loading WAV/AIFF Files in BR-900CD Tracks (WAV/AIFF Import).....	178
Importing SMFs and Creating Patterns.....	179
Loading Drum Sounds from WAV/AIFF Files (Tone Load)	181
Using the BR-864 / BR-532's Data.....	183

Section 8 Other Convenient Functions . 185

Adjusting the Display Contrast..... 186

Using a Foot Switch or Expression Pedal..... 187

When Using a Foot Switch.....187

When Using an Expression Pedal187

Tuning an Instrument (Tuner)..... 188

Changing to the Tuner188

Explanation of the indications that appear while
tuning.....188

Tuning189

Setting the Reference Pitch of the Tuner189

Mixing the Output from an External MIDI Device with the Output from Your BR-900CD (Audio Sub Mix) 190

Using Condenser Microphones (Phantom Power) 191

Copying Difficult Songs (Phrase Trainer)..... 192

Slowing Down the Speed (Time Stretch)192

Canceling the Center Sound (Center Cancel).....192

Initializing the BR-900CD's Settings 194

Initializing All the BR-900CD's Settings194

Initializing the System Settings194

Initializing the Effect Settings.....195

Initializing the Rhythm Arrangements/Patterns/
Drum Kits195

Initializing the Memory Card196

Conserving Battery Power (Power Save)..... 197

Deactivating the power save function197

Utility Parameter List 198

About the System Parameters198

About the Sync Parameters198

About the Scrub Parameters199

Section 9 Appendices201

Effect Patch List 202

Mastering Tool Kit Patch List..... 205

Pitch Correction Patch List..... 205

Arrangement / Pattern List..... 206

Preset Arrangement List.....206

Preset Pattern List.....207

Parameter List..... 208

Troubleshooting 211

Error Messages 213

MIDI Implementation 216

MIDI Implementation Chart..... 219

Specifications 220

Index 222

Track Sheet 230

Introduction to the BR-900CD

Features

Simple operation

The BR-900CD is designed to be operated as easily as a cassette tape recorder, even by beginners.

The BR-900CD allows anyone to readily enjoy the benefits of digital recording as soon as it's taken out of the box. So, you'll surely have listened to the demo songs, if not gone ahead and produced an entire audio CD, all on your first day with your new unit.

In addition, it comes equipped with a CD-R/RW drive, making it easy to keep recorded works stored on audio CDs.

Digital audio workstation

All processes are fully digital

In addition to a digital mixer and digital recorder, the BR-900CD contains five digital effects processors.

It is possible to perform all steps needed for recording, including editing, bouncing tracks, using effects, and mixing down, entirely within the digital realm, so there is no deterioration in the signal quality.

Using the USB connector also allows you to save the song data you create to a computer.

Equipped with V-Tracks

The BR-900CD has eight audio recording tracks, which provides for simultaneous recording on two tracks, or simultaneous playback from eight tracks.

Moreover, each track incorporates eight virtual tracks, called "V-Tracks," for a total recording capability of $8 \times 8 = 64$ tracks! This increased versatility allows you to do things such as record numerous takes of a guitar solo, which you can later choose from when putting it all together. Also, while playing back eight tracks, you can use the bounce mode to bounce to a V-Track and perform stereo bouncing without needing to erase any data.

What are V-Tracks?

Each track consists of eight virtual tracks, and you can choose any one of these tracks for recording or playback. This means that you can record to up to a maximum of 64 tracks, and then select any eight of them to play back. These virtual tracks that make up the actual tracks are called "V-Tracks."

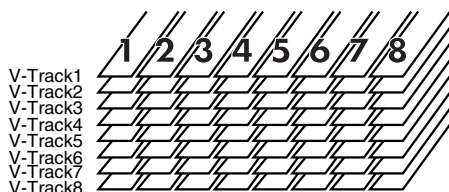

MEMO

A "Track Sheet" is provided at the rear of this manual (p. 230), which you make copies of, and fill in when recording music to V-Tracks.

Equipped with CD-R/RW Drive

The BR-900CD features a CD-R/RW drive capable of both reading and burning CD-R and CD-RW discs, making it easy to produce audio CDs of the performances you record.

In addition, you can back up performance data stored on memory cards to CD-R/RW discs for even more efficient and effective use of your memory cards.

NOTE

When you use the CD-R/RW drive, you must use only the supplied AC adaptor.

The CD-R/RW drive cannot be used while running on battery power.

Rhythm function

The "Rhythm function" makes it easy to capture phrases or musical ideas that come to mind. Simply select an appropriate Rhythm pattern, and set the tempo.

In addition to the internal preset Rhythm patterns already provided, you can also create your own original Rhythm patterns. By recording using the Rhythm function, editing one measure at a time is greatly simplified.



"Section 4 Using the Rhythm" (p. 119)

Five versatile digital effects processors

The BR-900CD comes with five different types of effects processors. These systems, including recording effects (Insert effects), send/return (Loop Effects), tone adjustment (Track EQ), vocal pitch correction (Pitch Correction), and mastering effects (Mastering Tool Kit) can be used independently for each application as needed. This enables high-quality song production in a single device, with no need to connect any external effects.

The BR-900CD has many built-in simulations and effects, including amp modeling with COSM for a wide variety of insert effects. Many effects for vocal, keyboard, and guitar tracks are also included for a vast array of applications.

The loop effects include spatial effects such as chorus and reverb, which are vital for proper stereo mixdown.

The Track EQ is a built-in, two-band EQ whose utility is most fully exhibited in making tone adjustments during mixdown.

The Pitch Correction feature allows you to freely adjust the pitch of vocals, assuring that you can obtain reliable, high-quality performances.

The Mastering Tool Kit allows you add compression to songs that have been mixed down and provides a variety of other effects.



“Using the Insert Effects” (p. 84)

“Using the Loop Effects/Track EQ” (p. 108)

“Fixing the Pitch of Vocals (Pitch Correction)” (p. 113)

“Mastering” (p. 102)

What is COSM (Composite Object Sound Modeling)?

Technology that virtually reconstructs an actually existing structure or material using a different means is called “modeling” technology. COSM is proprietary Roland technology that creates new sounds by combining various sound modeling technologies.

Editing functions

With the BR-900CD, you can perform editing operations such as copying, moving, and erasing, which cannot be done with multitrack recorders that use tapes. This means operations such as copying and repeating a multiple-bar phrase, moving a multiple-bar phrase to another track, and erasing the data of a track, whole or in part, can be performed with ease.

Non-destructive editing

Being a digital recorder, the BR-900CD offers non-destructive editing. With non-destructive editing, after performing any editing and recording operations, you can still return your data to its previous state (undo and redo functions).



“Canceling an Operation (Undo/Redo)” (p. 57)

Quick movement to a point

You can assign a marker to any point in a track that you wish (locator function). If you assign markers to locations such as the end of the opening or the beginning of a solo, you will be able to move instantly to the point where you wish to begin listening.



“Registering Time (Locator)” (p. 64)

Equipped with chromatic tuner (A0 to B6 sound range)

Your BR-900CD is also equipped with a chromatic tuner so that you can tune your guitar or bass while it is still connected to the BR-900CD (p. 188).

Phrase Trainer function

When you play back a song you have recorded from the CD player or the MD player, you can slow down the tempo without changing the pitch. Also, you can remove the sound you hear at the center (such as vocals and guitar solo) from the song. (p. 192)

Full complement of input connectors (jacks)

Your BR-900CD is equipped with the input jacks shown below.

GUITAR/BASS:

This high-impedance input jack allows you to directly connect your guitar or bass (accepts 1/4" phone plugs).

MIC1:

These jacks allow a mic to be connected. Both a TRS phone jack and an XLR jack are provided. Connect your mic here if recording vocals or narration.

A built-in microphone is also included, so you can perform recordings with the BR-900CD even when you don't have a microphone connected.

* *The built-in microphone can be turned on or off (p. 34).*

* *Phantom power can be supplied via the XLR connector (p. 191).*

MIC2:

This is XLR-type microphone input connector. If recording using two mics, with one mic connected to the MIC 1 input, connect the second mic here.

* *Phantom power can be supplied via the XLR connector (p. 191).*

LINE:

These jacks accept stereo input from keyboards, CD players, and other devices at line level (RCA phono jacks).

The LINE OUT jacks (stereo RCA phono jacks) are also provided for output.

USB:

Connecting your computer here allows you to exchange data between the BR-900CD and a computer.

Two-way power supply allows you to record anywhere

You can use the BR-900CD powered by batteries (six size AA dry cells) or with the AC adaptor.

And, thanks to its built-in microphone, you can make recordings anywhere and anytime you desire.

Memory Cards Supported by Your BR-900CD

The BR-900CD uses CompactFlash cards as the storage media for recording and playback.

The BR-900CD uses 32 MB to 1 GB CompactFlash cards with a 3.3 V power supply.

For more on supported memory cards (CompactFlash) for the BR-900CD, refer to "About Memory Cards" (separate sheet).

NOTE

CompactFlash Type II cards are not compatible.

MEMO

CompactFlash cards are available at your nearest computer or digital camera shop.

Formatting the memory card (CompactFlash)

CompactFlash cards bought at a computer shop, or ones previously used with a digital camera cannot be used as is with the BR-900CD.

These CompactFlash cards must first be initialized for use with the BR-900CD.

For more details regarding initializing, see p. 31, p. 196.

* CompactFlash and  are trademarks of SanDisk Corporation and licensed by CompactFlash association.

* BOSS Corporation is an authorized licensee of the CompactFlash™ and CF logo () trademarks.

How to remove the card protector

To prevent theft of the memory card (CompactFlash), the BR-900CD is shipped from the factory with a card protector.

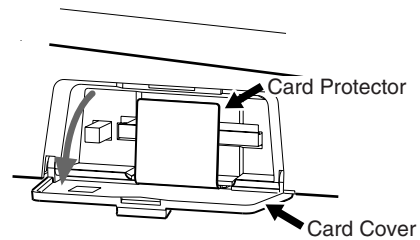

To remove the card protector, use the following procedure.

1. Make sure the card cover is closed, then the BR-900CD over.

- * When turning the unit upside-down, get a bunch of newspapers or magazines, and place them under the four corners or at both ends to prevent damage to the buttons and controls. Also, you should try to orient the unit so no buttons or controls get damaged.
- * When turning the unit upside-down, handle with care to avoid dropping it, or allowing it to fall or tip over.

2. Using a coin or flathead screwdriver, unscrew and remove the coin screw from the bottom panel.

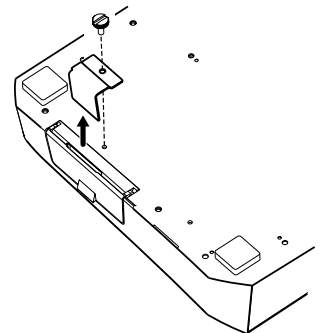

3. Pull out the card cover in the direction indicated by the arrow.

4. To prevent loss of the card protector after it is removed, place it as shown in the figure. Insert the card protector in the slot as indicated by the arrow.

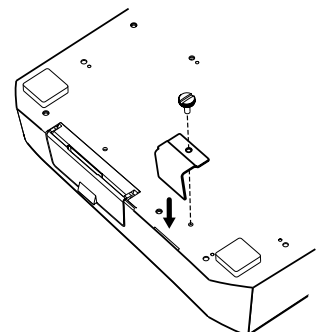

5. Turn the BR-900CD back over to its original position.

NOTE

Should you remove the screws, make sure to put them in a safe place out of children's reach, so there is no chance of them being swallowed accidentally.

Panel Descriptions

Front Panel

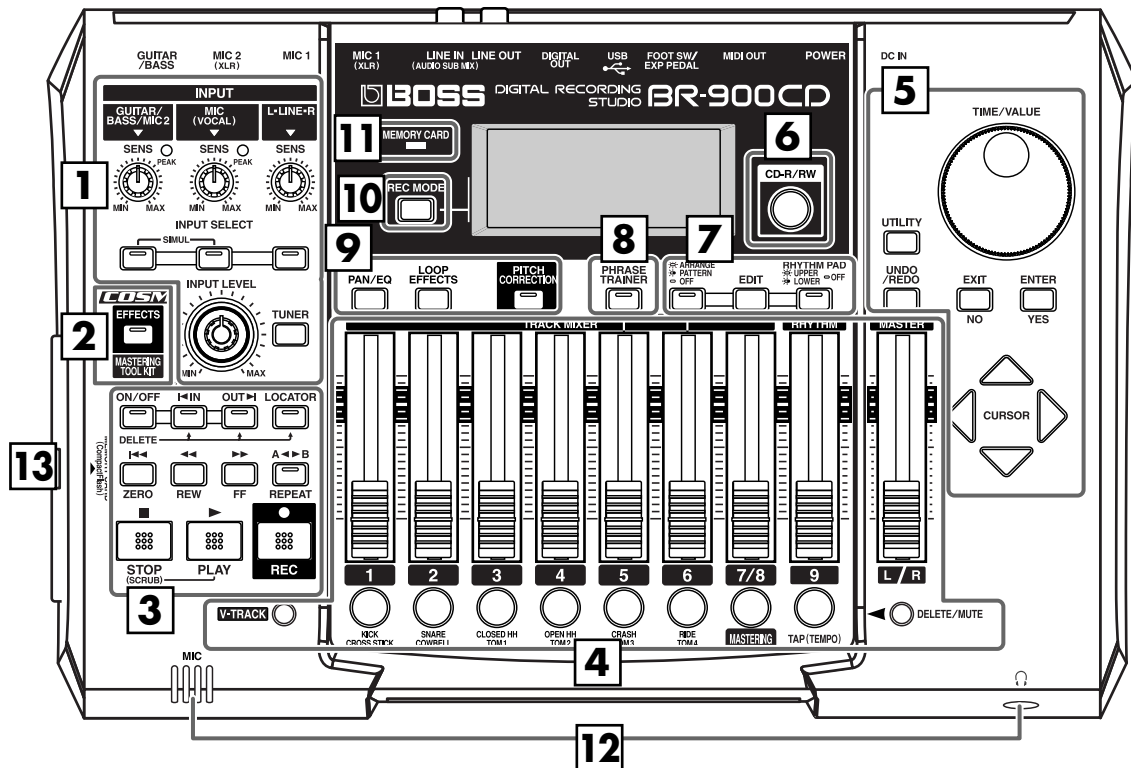

1 Input section

SENS knob

Use this knob to adjust the sensitivity at the input jacks (e.g., GUITAR/BASS, MIC1, MIC2, and LINE).

PEAK indicator

This indicator shows how strong the input level is at the various input jacks (e.g., GUITAR/BASS, MIC1, and MIC2). This indicator lights at a level -6 dB lower than where sound distortion occurs. Adjust the input sensitivity with the SENS knob so that this indicator lights only occasionally, at those moments when you play your guitar (or other instrument) at its loudest.

INPUT SELECT buttons

Use these buttons to select the input source (input jack) that you wish to record. The indicator of the selected button will light. You can mute (silence) the input sound by pressing a button that is lit.

[GUITAR/BASS/MIC2]

For selecting either guitar or bass use of the GUITAR/BASS jack, or the MIC 2 jack.

[MIC]

For selecting either the MIC1 jack, or the internal microphone.

* You can turn on and off the internal microphone. (p. 34)

[LINE]

For selecting the LINE jack (stereo) for the line inputs, such as keyboards or CD players.

SIMUL

By pressing [GUITAR/BASS/MIC2] and [MIC] simultaneously, you can record from both inputs at the same time.

* If the INPUT SELECT setting is changed, the insert effect bank (p. 35, p. 84) changes automatically.

INPUT LEVEL knob

Use this knob to adjust the volume of the input source for recording.

* If you use the INPUT LEVEL knob to turn down the volume of the input source during recording, the sound will be recorded in the audio track at a low volume, so that noise will be more apparent when you raise the volume of the audio track for playback. If you want to lower the sound of the input source that you are monitoring, lower the volume with the MASTER fader. To change the volume of the music being played back, use the TRACK fader for the respective tracks.

[TUNER]

Use this button to turn on and off the tuner (p. 188).

This allows you to tune your instrument connected to the GUITAR/BASS jack.

2

[EFFECTS]

Use this button to turn on and off the insert effects (p. 35, p. 84) or call up the screen for editing the various settings.

This button is used to make settings for the Mastering Tool Kit.

3 REC/PLAY section

AUTO PUNCH

This button is used to make settings for the automatic punch in/out function.

[ON/OFF]

This turns the auto punch-in/out function on/off. When this is on, the button indicator will light.

[IN]

For setting the auto punch-in location. Press this button to set the punch-in point. When set, the indicator on this button will light. After the punch-in location is set, you can press this button to automatically move to the punch-in location.

* *Press this button while holding down [ON/OFF] to clear the set punch-in location.*

[OUT]

For setting the auto punch-out location. Press this button to set the punch-out location at the current location in the track. When set, the indicator on this button will light. After the punch-out location is set, you can press this button to automatically move to the punch-out location.

* *Press this button while holding down [ON/OFF] to clear the set punch-out location.*

[LOCATOR]

Use this button to store any location that you desire. Then, by pressing this button, you can automatically move to that location.

When a location is set, the indicator on this button will light and you will jump to the location each time this button is pressed.

* *Press this button while holding down AUTO PUNCH [ON/OFF] to clear the set location.*

[ZERO]

Moves you to the time location 00:00:00.0.

[REW]

The song will rewind while you hold down the button.

[FF]

The song will fast-forward while you hold down the button.

[REPEAT]

You can specify a region that you wish to hear, and hear it repeatedly (p. 51).

This feature is useful if you want to repeatedly play back the recording between the punch-in and out locations (p. 53) until you are satisfied or use the phrase trainer (p. 192) to try to copy a difficult phrase recorded from a CD or the like.

[STOP]

Stops recording or playback of the song.

[PLAY]

Plays back songs. When [REC] is pressed and the REC indicator is flashing, press [PLAY] to start recording. During recording or playback, the indicator on the button lights in green.

[REC (Recording)]

This is the Record button. In addition to the Recording operation, it is also used for manual punch-in/out. While in recording standby, the indicator on this button flashes in red, and during recording, it lights in red.

4 Track/Fader section

TRACK MIXER fader 1-6, 7/8

For controlling the volumes of each track during playback.

* *Hereafter, the TRACK MIXER faders shall be referred to as the "TRACK faders."*

RHYTHM fader

Adjusts the volume of the Rhythm.

MASTER fader

Controls the overall volume of the BR-900CD.

[V-TRACK]

Use this button to call up the screen for selecting a V-Track.



"What are V-Tracks?" (p. 14)

"Changing V-Tracks" (p. 49)

REC TRACK (Recording Track) buttons 1-6, 7/8

Use these buttons to select to which track you will record.

The button of the track selected will flash in red and then light in red when recording begins. When recording is finished, the button of the selected track will light alternately in orange and green.

The relationship between the indicator and the track conditions is given below.

Off:

This track contains no recorded data.

Green:

An audio track that contains recorded data.

Flashing in red:

The track is selected as the recording destination, and is in recording standby.

Red:

This track currently being recorded.

Lighting alternately in orange and green:

This track contains recorded data and is selected for recording.



During creation of Rhythm patterns (p. 126), a rhythm instrument is assigned to each button.

[TAP (TEMPO)]

By tapping this button, you can set the tempo for the Rhythm.

[DELETE/MUTE]

By holding down this button and pressing a REC TRACK button whose indicator is lit in green and orange alternating or green, you can mute that track during playback, regardless of the position of its TRACK fader (p. 41). When you repeat the same action, muting will be defeated. While muted, the REC TRACK button of that track will flash in green and orange alternating.

* If a recording track was muted, muting will be defeated when recording ends.



During creation of Rhythm patterns (p. 126), you can delete rhythm sounds you have input by holding down this button and pressing the REC TRACK button.

5

TIME/VALUE dial

You can use this dial to shift the current position within a song (e.g., fast forwarding and rewinding). It is also used to change the values of the various function settings.

[UTILITY]

This button calls up various functions offered by your BR-900CD, such as track editing, song management, and memory card operations.

[UNDO/REDO]

For undoing the last-performed recording or editing operation and returning the data to its previous state. By pressing this button once again, you can bring back the canceled recording or re-execute the editing operation (p. 57).

[EXIT/NO]

Press this button to return to the previous screen or cancel the last entry.

[ENTER/YES]

Press this button to confirm a selection or a value being entered.

CURSOR buttons

Press these buttons to move the cursor within the screen.

6

[CD-R/RW]

The BR-900CD uses this drive unit to read from, write to, and play CD-R/RW discs.

7

Rhythm section

Here you can make settings for the Rhythm function.

[ARRANGE/PATTERN/OFF]

Pressed to cycle the Rhythm function through the available selections: Arrangement → Pattern → Off.

[EDIT]

This calls up the screen for programming arrangements and patterns.

[RHYTHM PAD]

This button switches the TRACK button functions to Rhythm input.



“Section 4 Using the Rhythm” (p. 119)

8

[PHRASE TRAINER]

Use this button to perform the settings for the phrase trainer function.

When using the phrase trainer, you can turn on or off the center cancel function (for removing vocals at the center), or the time stretch function (for slowing down playback).



“Canceling the Center Sound (Center Cancel)” (p. 192)

“Slowing Down the Speed (Time Stretch)” (p. 192)

9

[PAN/EQ]

Pressed to access a screen where you can set the pan (left/right location of the sound) for the playback of each track or for the input sound (p. 42, p. 49).

This, also, adjusts the tone (Low, High) for each track (p. 42, p. 110).

[LOOP EFFECTS]

Use this button to call up the screen for setting the send level of each track respective to the loop effects (p. 43, p. 108), switching between reverb and chorus, setting the various parameters, and more.



“Using the Loop Effects/Track EQ” (p. 108)

“Loop Effect Parameter Functions” (p. 111)

[PITCH CORRECTION]

Use this button to turn on and off the Pitch Correction. This function adjusts the pitch of recorded vocals.



“Using the Pitch Correction” (p. 114)

10

[REC MODE (Recording Mode)]

This button is used for selecting the recording mode.



Basic recording (p. 39, p. 48)

Bounce (Putting multiple tracks together) (p. 45, p. 58)

“Mastering” (p. 102)

11

MEMORY CARD indicator

This indicator will light up whenever data is being read from or written to a memory card.



Never turn off the power while the indicator is lit. This may corrupt the data on the memory card, possibly rendering the card unusable.

12

MIC (Internal microphone)

This microphone can be used for recording with the BR-900CD.



“Press the INPUT SELECT button of the instrument that you want to record” (p. 34)

“Turning on the internal microphone” (p. 34)

Headphones jack ()

Headphones (sold separately) are connected here. When headphones are connected, the same output as that from LINE OUT can be heard from the headphones.

* The headphone volume is adjusted with the MASTER fader.

13 MEMORY CARD slot

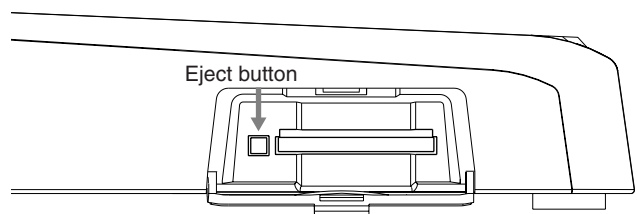

This slot is where memory cards (CompactFlash) are inserted when you want to save data. You cannot record unless you have a memory card inserted here.

Eject button

Press this button to eject the memory card.

CD-R/RW drive

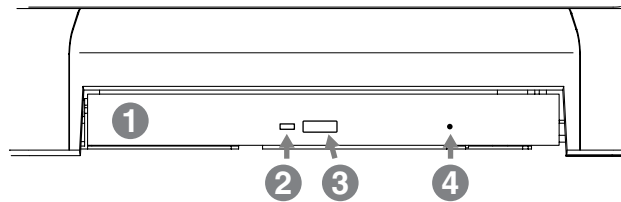

NOTE

Before you use the CD-R/RW drive, it is important that you first of all read “Before Using CD-R/RW Discs” (p. 6).

1. Disc tray

Place the CD-R/RW discs on this tray.

2. Access indicator

This indicator will light up whenever data is being read from or written to a CD-R/RW disc.

3. EJECT button

Press this button to eject a CD-R/RW disc from the drive unit. Note that it will only be possible to eject the CD-R/RW disc while the BR-900CD is powered up.

NOTE

If excessive force is used to extract a disc, you risk causing damage to the drive.

4. Emergency eject hole

This hole is used when the disc tray must be opened in an emergency.

It must not, therefore, be used on a regular basis and should be treated as a last resort only when the disc cannot be ejected in any other way (p. 7).

Display

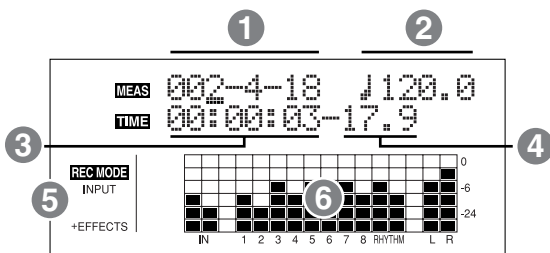

Displays the menu screen, parameter setting screen, or other information, depending on the type of settings being made.

If the screen is difficult to view, see “Adjusting the Display Contrast” (p. 186).

1. MEAS (MEASURE)

Displays the current position within the song. Indicated from left to right are the measure, beat, and clock.

2. TEMPO

The Rhythm tempo is indicated here.

3. TIME

Displays the time of the current position of the song (hours-minutes-seconds).

4. FRAME

Displays the frame number of the current position of the song.

At the factory settings, one second is set to 30 frames (non-drop). This is one type of a specification known as MTC (MIDI Time Code), and when you use the BR-900CD to play in synchronization with another MIDI device, you will need to set both devices to the same MTC type.



“Synchronizing Playback with a MIDI Sequencer” (p. 158)

5. REC MODE

The recording mode is indicated here.

6. Level Meter

During play mode, the volume levels of instruments being input, and volume levels of each track are displayed.

The levels displayed are the levels after the adjustments are made with the INPUT LEVEL knob and TRACK fader (i.e., post fader). You can select the level meter to display each type of level being set.

Rear Panel

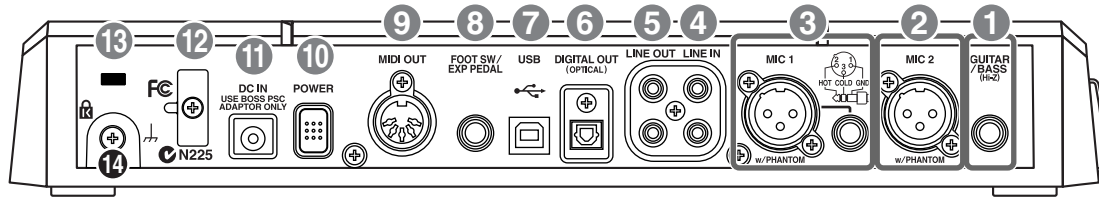

1. GUITAR/BASS jack

High-impedance input jack to directly connect your guitar or bass.

2. MIC2 jack (XLR types)

This jack allows a mic to be connected. XLR jack is provided.

The BR-900CD can supply phantom power to a condenser microphone connected to this connector (p. 191).

* If the connection has been made to the GUITAR/BASS and the MIC2 jacks, the GUITAR/BASS jack is given priority.

3. MIC1 jacks (TRS/XLR types)

These jacks allow a mic to be connected. Both standard TRS jacks (p. 26) and XLR jacks are provided.

The BR-900CD can supply phantom power to a condenser microphone connected to this connector (p. 191).

* If microphones are connected to both jacks, the TRS jack is given priority.

4. LINE IN jacks

These are input jacks for analog audio signals. These jacks are used to connect CD players and other audio devices and keyboards, rhythm machines, and other external sound modules.

5. LINE OUT jacks

These are output jacks for the analog audio signal. You can connect tape recorders, or other recording devices to record the output analog signal from the BR-900CD.

6. DIGITAL OUT connector

Optical connector for outputting digital audio signals. The same sound that is output from LINE OUT is also output from DIGITAL OUT. You can connect a DAT recorder or CD recorder to this connector and make digital recordings of the BR-900CD's output.

7. USB connector

This is the connector for connecting your computer to the BR-900CD with a USB cable.

8. FOOT SW/EXP PEDAL jack

This is an input jack for connecting a separately sold foot switch (BOSS FS-5U, Roland DP-2) or expression pedal (BOSS Roland EV-5, BOSS FV-300L).

By using this FOOT SW jack, you can start/stop playback, punch in/out, and more.

When an expression pedal is used, you can control the depth of insert effects with your foot.



“Using a Foot Switch or Expression Pedal” (p. 187)

9. MIDI OUT connector

Connector for sending MIDI data. Connect it to the MIDI IN connector of an external MIDI device (rhythm machine or sound module).

10. POWER switch

This is the power switch. It turns the power of the BR-900CD on/off.

11. DC IN (AC Adaptor) jack

Connect the supplied AC adaptor (PSC-series) to this jack.



You must use only the PSC-series AC adaptor. Use of any other adaptor may cause overheating or malfunctions.

12. Cord Hook

Wrap the cable around this hook so that the AC adaptor cable is not pulled out accidentally.

* If the AC adaptor is disconnected during operation, your important recorded data may be lost.

13. Security Slot (K)

<http://www.kensington.com/>

Depending on the circumstances of a particular setup, you may experience a discomforting sensation, or perceive that the surface feels gritty to the touch when you touch this device, microphones connected to it, or the metal portions of other objects, such as guitars.

This is due to an infinitesimal electrical charge, which is absolutely harmless. However, if you are concerned about this, connect the ground terminal (rear panel: see figure 14) with an external ground. When the unit is grounded, a slight hum may occur, depending on the particulars of your installation.

If you are unsure of the connection method, contact the nearest Roland Service Center, or an authorized Roland distributor, as listed on the "Information" sheet.

Unsuitable places for connection

- Water pipes (may result in shock or electrocution)
- Gas pipes (may result in fire or explosion)
- Telephone-line ground or lightning rod (may be dangerous in the event of lightning)

Inserting Batteries

- 1. Make sure that the power of the BR-900CD is turned off.**
- 2. Remove the battery cover on the rear panel.**
 - * When turning the unit upside-down, get a bunch of newspapers or magazines, and place them under the four corners or at both ends to prevent damage to the buttons and controls. Also, you should try to orient the unit so no buttons or controls get damaged.
 - * When turning the unit upside-down, handle with care to avoid dropping it, or allowing it to fall or tip over.
- 3. Being careful not to reverse the polarity (+/-), insert six AA dry-cell batteries into the battery compartment.**
 - * BOSS recommends using longer-life alkaline batteries.
 - * Do not mix new batteries with partially used batteries, and do not mix batteries of differing types.
 - * Do not use rechargeable batteries.
- 4. Close the battery cover.**

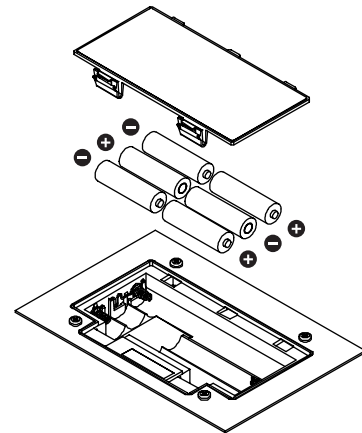

When the battery power becomes low, "Battery Low!" appears in the display. When this message appears, replace the existing batteries with new ones as soon as possible.

MEMO

Quick Start

Connecting Peripheral Devices

Make connections as shown in the diagram below. When making any connections, make sure that all devices are turned off.

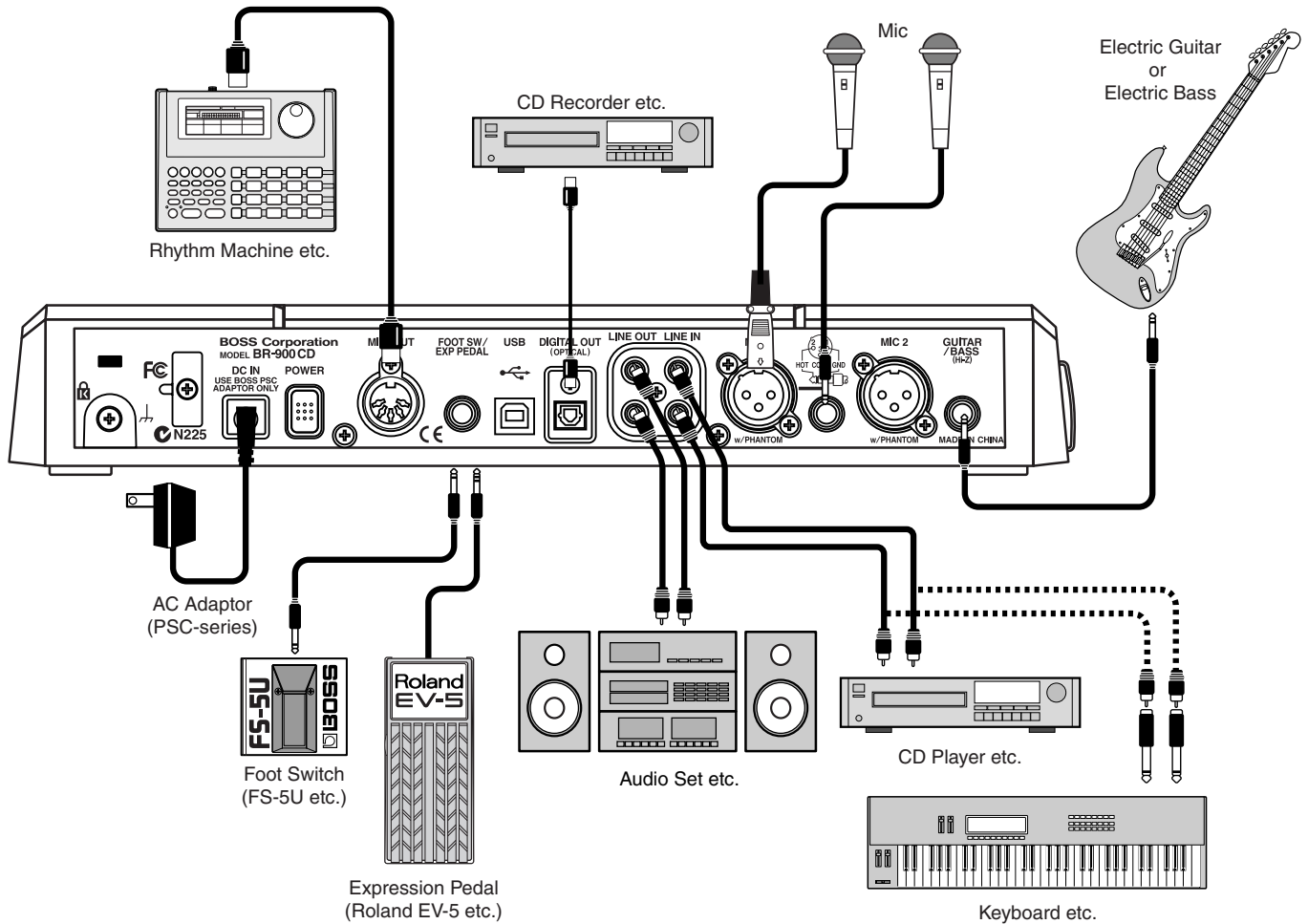

NOTE

To prevent malfunction and/or damage to speakers or other devices, always turn down the volume, and turn off the power on all devices before making any connections.

- To prevent the inadvertent disruption of power to your unit (should the plug be pulled out accidentally), and to avoid applying undue stress to the AC adaptor jack, anchor the power cord using the cord hook, as shown in the illustration.

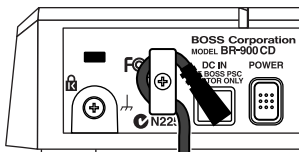

- Feedback could be produced depending on the location of microphones relative to speakers. This can be remedied by:
 1. Changing the orientation of the microphone(s).
 2. Relocating microphone(s) at a greater distance from speakers.
 3. Lower the volume.

* Two types of MIC inputs are included, TRS phone type jacks compatible with balanced input, and XLR type connectors. The pin assignment for the MIC jack is as shown below. Before making any connections, make sure that this pin assignment is compatible with that of all your other devices.

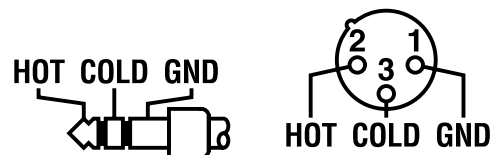

- * When using the FS-5U foot switch (sold separately), set the polarity switch as shown below. If the polarity switch is not set correctly, the foot switch may not operate properly.

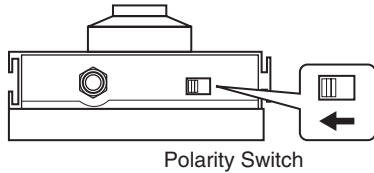

- * You can also use an FS-6 (optional) for the foot switch. If using an FS-6, connect to only one of the FS-6's jacks, either the A or B jack. Additionally, set the polarity switch to "FS-5U." The A&B jack cannot be used.
- * If using an expression pedal (EV-5 or FV-300L), set the MIN volume level to "0."

Inserting a Memory Card

Insert the memory card (CompactFlash) with the gold-colored contacts facing downward (the side without contacts should be facing upward).

- * Carefully insert the memory card all the way in-until it is firmly in place.
- * Do not touch the contacts of the memory card or allow them to become dirty.

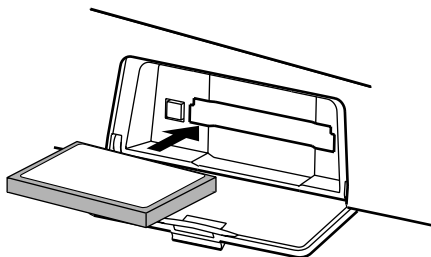

NOTE

Before inserting the memory card, be sure to first turn off the BR-900CD. If a memory card is inserted when the power is turned on, the data in the memory card may be destroyed, or the memory card may become unusable.

Turning On / Off the BR-900CD

Turning On the Power

Once the connections have been completed, turn on power to your various devices in the order specified. By turning on devices in the wrong order, you risk causing malfunction and/or damage to speakers and other devices.

1. Before you turn the power on, make sure of the following points.

- Are all external devices connected properly?
- Is the volume on the BR-900CD and all other devices completely lowered?
- Is the memory card inserted?

* The BR-900CD is shipped with a memory card already inserted in the slot.

2. Lower the MASTER fader on the BR-900CD.

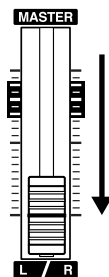

3. Turn on the devices connected to the input jacks (i.e., GUITAR/BASS, MIC 1, MIC 2, or LINE IN).

4. Turn on the POWER switch located on the rear panel.

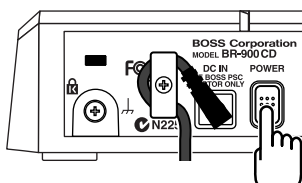

* Always make sure to have the volume level turned down before switching on power. Even with the volume all the way down, you may still hear some sound when the power is switched on, but this is normal, and does not indicate a malfunction.

* This unit is equipped with a protection circuit. A brief interval (a few seconds) after power up is required before the unit will operate normally.

5. Turn on the device connected to the output jack (i.e., LINE OUT or DIGITAL OUT).

NOTE

If you are using the AC adaptor, make sure that the AC adaptor does not become unplugged during operation. If the AC adaptor becomes unplugged accidentally, the recorded data may become damaged.

Turning Off the Power

1. Make sure that playback of the song is stopped.

NOTE

Always make sure that the recorder is stopped before turning off the power to the BR-900CD. Turning off the power while recording or playback is in progress may result in the deletion of (song) data, mixer settings, and/or effect patch data.

2. Turn off the power to each device in the reverse order used for powering up.

3. Turn the BR-900CD's POWER switch off.

Play Screen

The Play screen is the most fundamental screen of the BR-900CD, and is the first screen that appears when the BR-900CD is turned on (see below).

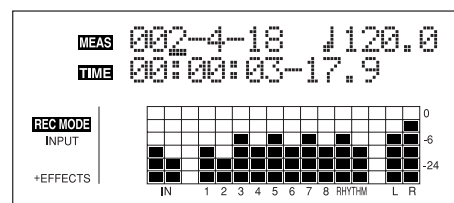

Listening to a Demo Song

Selecting a song (Song Select)

Upon power-up, the song that was selected before the power was turned off is selected, and the data of that song is loaded. As soon as the data has been loaded, the Play screen appears in the display.

To listen to a demo song, follow the procedure given below.

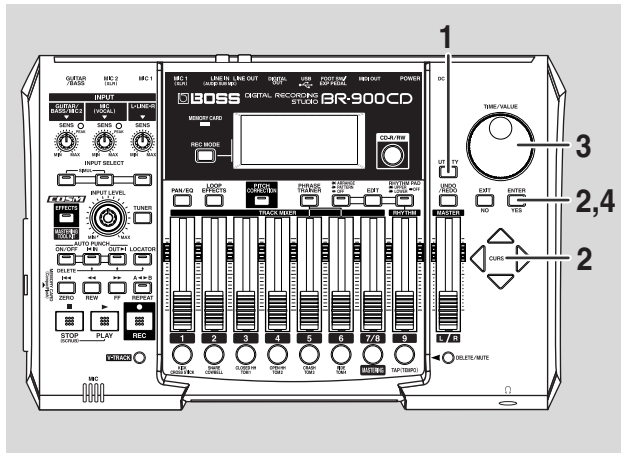

1. Press [UTILITY].
2. Press CURSOR [< | >] to move the cursor to "SEL," and press [ENTER].

The Song Select screen appears.

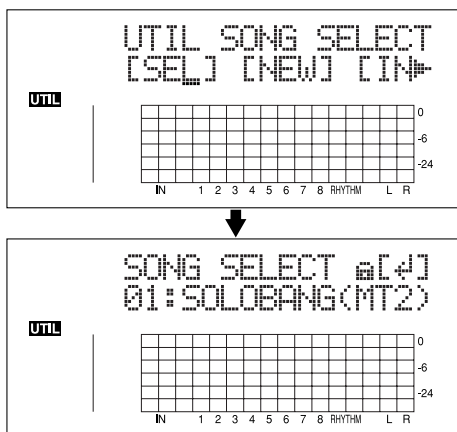

3. Turn the TIME/VALUE dial to select "01: SOLOBANG."

Title	Composer	Copyright
SOLOBANG!	Yutaka Nakano	Copyright © 2005 BOSS Corporation

4. Press [ENTER].

■ If you have changed the recording or editing

Since the BR-900CD automatically updates the recorded data and operation content if the recording or editing have been changed, you do not need to perform any special operations for saving.

During updating, "Keep power on!" appears in the upper line of the display, while the lower line shows what is being processed.

* If you try to record or edit data using a protected demo song, "Protected!" appears.

Playing back a song

1. Move the TRACK faders 1–6, 7/8 and the RHYTHM fader to the positions shown in the figure below, and lower the MASTER fader.

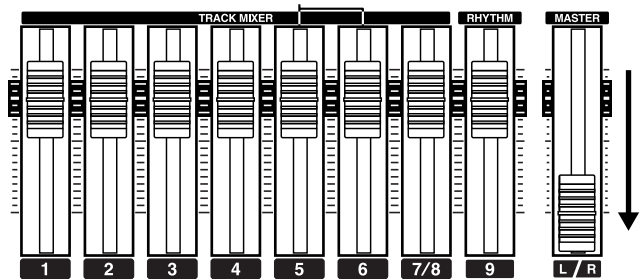

2. Press [PLAY].

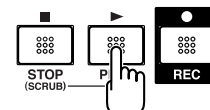

The song starts. Slowly increase the MASTER fader and adjust the volume to the desired level.

NOTE

Use of the demo song supplied with this product for any purpose other than private, personal enjoyment without the permission of the copyright holder is prohibited by law. Additionally, this data must not be copied, nor used in a secondary copyrighted work without the permission of the copyright holder.

MEMO

By adjusting the TRACK faders, you can listen to the individual sounds recorded to each track one at a time or listen to them at the balance you desire.

Press [FF] to fast-forward the song and press [REW] to rewind the song. Press [ZERO] to move to the time location 00:00:00-00.0.

In addition to the procedures given above, you can also change your current position in the song using the procedures given below.

Changing the current position

Elapsed time display

The value given at "TIME" in the display shows the elapsed time into the song using MTC (MIDI time codes) and is expressed as follows: hours-minutes-seconds-frames-sub frames.

The time code specifications can differ depending on the device. To synchronize operation with another device using MTC, you will first need to match the time code specifications of both devices. At the factory settings, one second is set to 30 frames (non-drop) (p. 158).

Moving to the start of a play

To move to the time where the first sound of a song is recorded, press and hold [STOP] and press [REW].

Each V-Track of the selected track is checked and you move to the time of the first recorded sound for the song.

Press [ZERO] to move to the time location 00:00:00-00.0.

Moving to the end of a play

To move to the time where the last sound of a song is recorded, press and hold [STOP] and press [FF].

Each V-Track of the selected track is checked and you move to the time of the last recorded sound for the song.

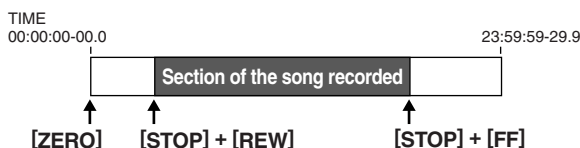

Moving through a song using hours, minutes, seconds, frames, or sub frames

Press [◀] [▶] to move the cursor to hours, minutes, seconds, frames, or sub-frames display, and turn the TIME/VALUE dial to change the current time in the song.

Moving through a song in measures or beats

The current position's measure-beat-clock are displayed at the location "MEAS" (measure) in the display.

* For the demo songs, a Arrangement (p. 37, p. 120) has already been created and it is set so that measure, beat, clock, and song is properly synchronized.

Press [◀] [▶] to move the cursor to "measure" or "beat" display, and turn the TIME/VALUE dial to change the current measure or beat in the song.

* You cannot move the cursor to Clock (cannot be altered).

Recording/Playing Back a Song

(1) Preparing the Memory Card

The BR-900CD writes the recorded data directly to the inserted memory card. Therefore, for recording or playback, the memory card must be inserted.



“Memory Cards Supported by Your BR-900CD” (p. 16)

Inserting the memory card



Before inserting the memory card (CompactFlash), be sure to first turn off the BR-900CD. If a memory card is inserted when the power is turned on, the data in the memory card may be destroyed, or the memory card may become unusable.

1. Insert the memory card into the memory card slot.

The supplied memory card still has some remaining space; however, for extended recording, you will need to erase some of the demo song or prepare a new memory card (64 MB or greater is recommended).

* The demo songs are protected.

To delete the demo songs, first remove the protections, then carry out the deletion.



“Protecting a Song (Song Protect)” (p. 79)

“Erasing Songs (Song Erase)” (p. 77)

(2) Turning On the Power

Use the procedure described in “Turning On the Power” (p. 28).

Formatting the memory card (Initialize)

* This is not necessary for memory cards that have already been used with the BR-900CD.

Newly purchased memory cards, or memory cards that have been used previously with a computer will need to be prepared so they can be used with the BR-900CD.

Carry out the following steps in the order given to complete the procedure (this preparation process is called “Initializing”).

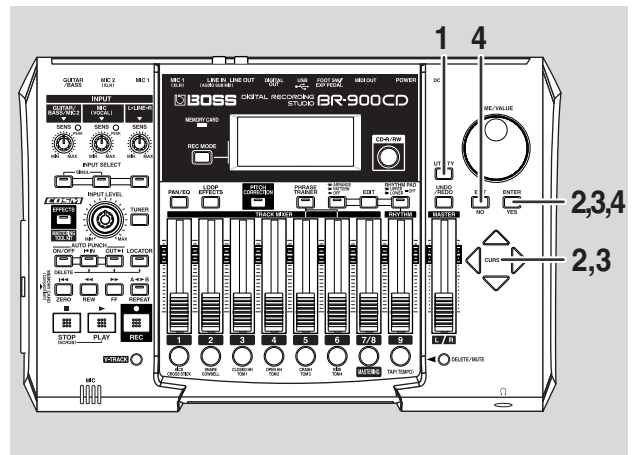

1. Press [UTILITY].

2. Press CURSOR [◀] [▶] to move the cursor to “INI,” and press [ENTER].

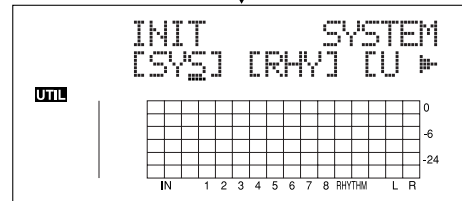
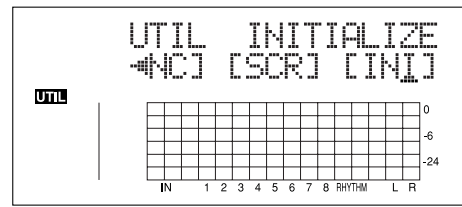

3. Press CURSOR [◀] [▶] to move the cursor to “CARD,” and press [ENTER].

“Are you sure?” appears.

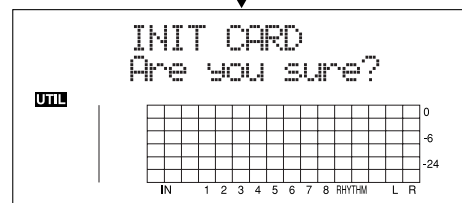
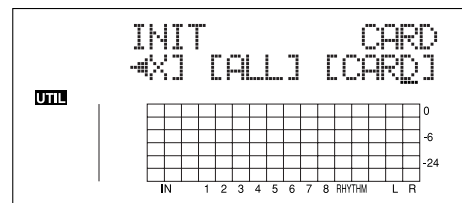

4. To continue with the initializing, press [ENTER] (YES). To cancel the operation, press [EXIT] (NO) (or [UTILITY]).

When [ENTER] (YES) is pressed, initializing begins.

When the initializing has been completed, "Completed!" appears in the display.

"Keep power on! Song creating..." then appears in the display, and a new song is automatically created.

In this case, the data type selected is HiFi (MT2).

When creation of the song is finished, the play screen returns to the display.

- * Depending on the capacity of the memory card, initializing may take more than ten minutes to complete. This is not a malfunction. The progress of the initializing is shown in the display. Do not turn off the BR-900CD until the initializing has been completed.

NOTE

Do not remove the memory card or turn off the BR-900CD while the display shows "Keep power on!" Doing so can destroy the data on the memory card and/or render the memory card itself unusable.

(3) Selecting the Song to Record

When the memory card contains more than one song, the song that was recorded last is automatically selected.

To record a new song, follow the procedure given below.

Recording a new song (Song New)

About data types

When you record a new song, the BR-900CD allows you to set the data type. This enables you to select the combination of audio quality and recording time that is most suitable for the material you are recording. The following data types can be selected.

- * The data type of a song cannot be changed after it is created.

HiFi (MT2) (multitrack 2):

For high-quality recordings. This data type is recommended when you will be doing a lot of track bouncing. Normally you should select this type. Use this type for most of your recordings.

STD (LV1) (live 1):

For recordings that will take longer than what can be provided with the MT2 data type. This is the most suitable setting for recording live performances.

LONG (LV2) (live 2):

Of the three data types, this provides the longest recording time. This is convenient when the card has little recording capacity.

Recording time

The recording times possible for each data type on one memory card are given below (when recording one track).

Data type	Recording time (times approximate)		
	HiFi (MT2)	STD (LV1)	LONG (LV2)
32 MB	16 min.	19 min.	24 min.
64 MB	32 min.	39 min.	49 min.
128 MB	65 min.	78 min.	98 min.
256 MB	130 min.	156 min.	196 min.
512 MB	260 min.	312 min.	392 min.
1 GB	520 min.	624 min.	784 min.

- * The recording times shown above are approximate. Depending on the number of songs, the allowable recording time may decrease.
- * The recording times shown above are for when only one track is used. For example, if you record on all eight tracks, the recording time for each track will be 1/8th of the time shown above.
- * The CompactFlash memory cards supported by your BR-900CD are 32 MB to 1 GB CompactFlash cards for use with a 3.3 V power supply voltage.

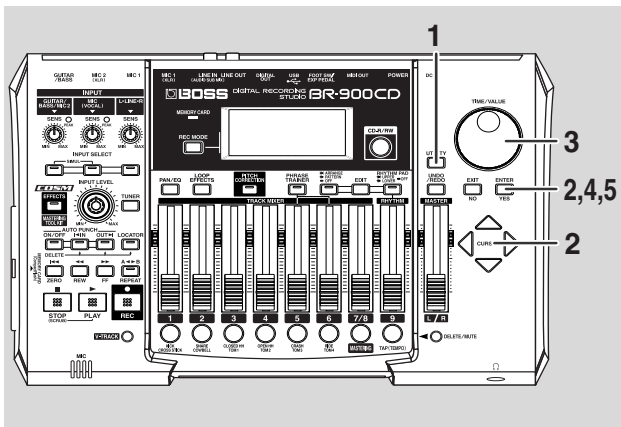

1. Press [UTILITY].
2. Press CURSOR [◀] [▶] to move the cursor to "NEW," and press [ENTER].
"Type" appears in the display.

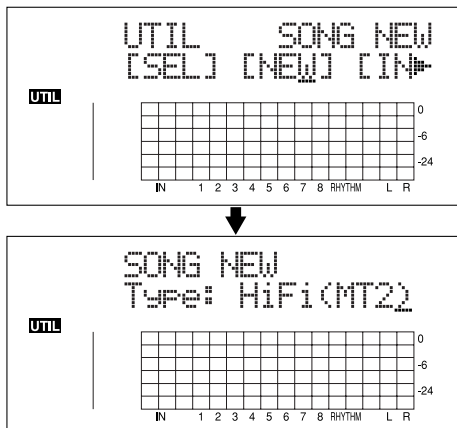

3. Turn the TIME/VALUE dial to select the desired data type.

* The BR-900CD uses a sample rate of 44.1 kHz. It is not possible to change the sample rate.

4. Press [ENTER].
"Are you sure?" appears.

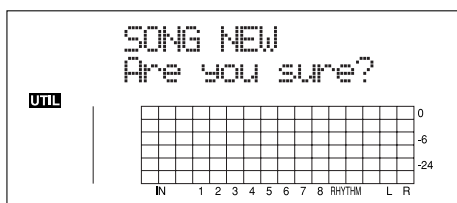

5. Press [ENTER].

When the new song is ready, you are returned to the Play screen.

* During updating, "Keep power on!" appears in the upper line of the display, while the lower line shows what is being processed.

(4) Connecting Instruments

Choose which jack you will use to connect your instrument

Your BR-900CD is equipped with a number of input jacks to match the type of instrument that you will connect. Select an instrument appropriate for your purposes.

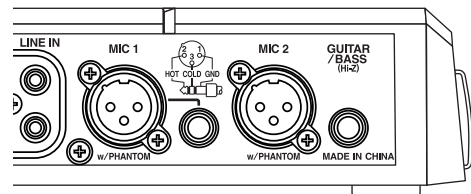

GUITAR/BASS:

An electric guitar or bass can be connected to this jack. Since this is a high-impedance input, a guitar or bass can be connected directly.

MIC1:

These jacks allow a mic to be connected. Both standard TRS and XLR jacks are provided.

The standard TRS type allows for both balanced and unbalanced connections.

- * If both jacks are being used, the TRS jack is given priority.
- * If you are recording an electric acoustic guitar using a shielded connection, use the GUITAR/BASS jack.
- * Phantom power can be supplied via the XLR connector (p. 191).

MIC2:

This jack allows a mic to be connected. XLR jack is provided.

- * If the connection has been made to the GUITAR/BASS and the MIC2 jacks, the GUITAR/BASS jack is given priority.
- * Phantom power can be supplied via the XLR connector (p. 191).

LINE:

When connecting to the output of a CD player, cassette player, or other audio device, or to a rhythm machine, external sound module, keyboard, or other sound source, use the stereo input jacks.

Press the INPUT SELECT button of the instrument that you want to record

Select the input source to record. The indicator of the selected button will light.

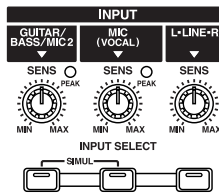

[GUITAR/BASS/MIC2]

Select to record the instrument connected to the GUITAR/BASS jack or MIC 2 jack.

[MIC]

Select to record the signal from a microphone connected to the MIC1 jack or from the internal microphone.

When the MIC indicator for the INPUT SELECT button is lit, you can use both the microphone connected to the MIC1 jack and the internal microphone simultaneously.

* Your BR-900CD is shipped with its internal microphone turned off. When not using the internal microphone, be sure to turn it on (see next section).

[LINE]

Select this when you wish to record the sound of an instrument or CD player connected to the LINE jacks.

[SIMUL]

To record the vocal and guitar at the same time, press [GUITAR/BASS/MIC2] and [MIC] simultaneously. Both indicators light, telling you that simultaneous recording is now possible.

You can select the source even when you have two mics connected simultaneously to the MIC 1 and MIC 2 inputs.

When two recording tracks are selected, the GUITAR/BASS/MIC2 is recorded to Track 1, 3, 5, 7, and the MIC1 is recorded to Track 2, 4, 6, 8.

When one recording track is selected, the GUITAR/BASS/MIC2 and MIC1 are mixed and then recorded.

Turning on the internal microphone

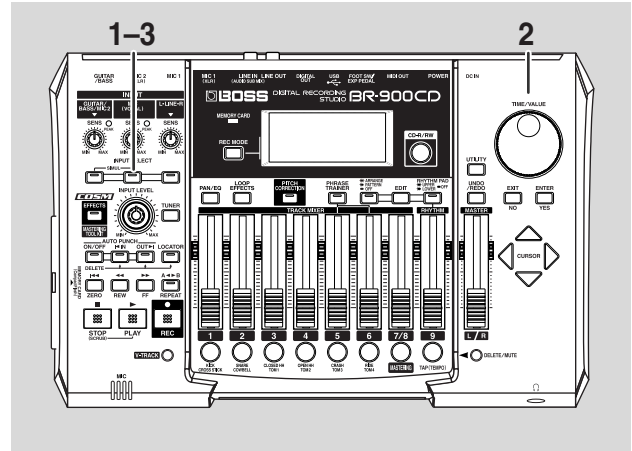

1. In the Play screen, press the [MIC] INPUT SELECT button.

The Mic Select screen appears while [MIC] is held down.

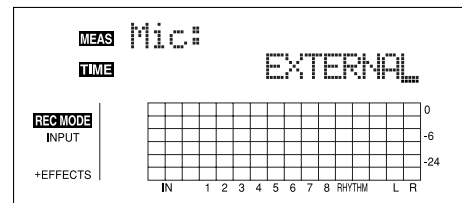

2. While still holding down [MIC], use the TIME/VALUE dial to select "ONBRD+EXT."

ONBRD+EXT:

The built-in mic is switched on, and the input is a mix of the sounds from the internal mic and the external mic connected to MIC 1.

EXTERNAL:

The built-in mic is switched off, and the input consists only of the sounds from the external mic connected to MIC 1.

3. Release [MIC].

The internal mic is switched on.

* During updating, "Keep power on!" appears in the upper line of the display, while the lower line shows what is being processed.

* You can also make the internal mic settings in the [UTILITY] system parameters. For more details, refer to the "Utility Parameter List" (p. 198).

Adjusting the input sensitivity

When input from GUITAR/BASS/MIC2 or MIC1 is selected, adjust their input sensitivity with the relevant SENS knob.

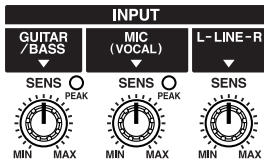

HINT

In order to record at a good sound level, you should adjust the input levels so that the PEAK indicator lights momentarily when a guitar is strummed strongly or vocals are sung loudly.

Adjusting the input level

Adjust the volume of the input source for recording.

1. Lower the MASTER fader.
2. Turn the INPUT LEVEL knob to its center position and then slowly increase the MASTER fader.

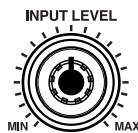

At this time, use the INPUT LEVEL knob to adjust the input level so that the level changes in the -12 (between -24 and -6)–0 dB range of the “IN” level meter.

The volume level is adjusted with the MASTER fader and INPUT LEVEL knobs.

Level meter display

This shows the volume levels for each track.

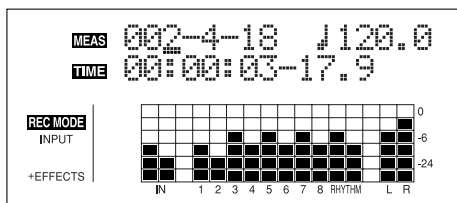

IN:

The level meter shows the input from INPUT.

1–8:

The level meter shows the output of Tracks 1–8.

RHYTHM:

The level meter shows the output of Rhythm.

LR:

The Level meter shows the post-MASTER fader output level. When monitoring the sound with headphones, use the MASTER fader to adjust the volume to the level you desire.

(5) Using Insert Effects

The BR-900CD comes with five onboard effects processors: an insert effect, loop effects, track EQ, pitch correction and mastering tool kit. Below is an explanation of the operations related to the insert effects.

What is an insert effect?

An effect added directly to a specific signal (with the BR-900CD, this refers to the instrumental sounds from an INPUT jack) is called an “insert effect.” The effect pedals that a guitarist connects between his guitar and amp are a type of insert effect. Loop effects, on the other hand, are effects connected to the send/return jack of mixers and other similar devices. (refer to p. 43)

Switch effect patches

The BR-900CD provides numerous effects for vocals, guitar, etc., and two or more of these effects can be used simultaneously. Such a combination of effects (i.e., the types of the effects used and the order in which they are connected) is called an “algorithm.”

Each effect in an algorithm offers a certain number of parameters, which allow the sound to be altered (similar to tweaking the knobs on a stomp pedal). The algorithm and its parameter settings are bundled into units called “effect patches.”

By changing the effect patch, you can simultaneously change the stored effect combinations, their on/off status, and the parameter settings, and completely change the sound.

1. Press [EFFECTS] to display the currently selected effect patch.

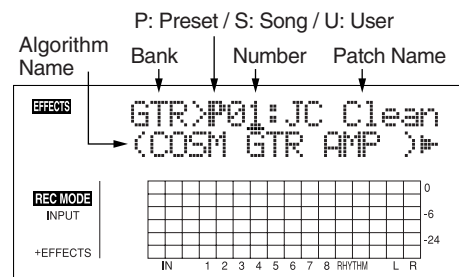

Your BR-900CD allows you to automatically select the most suitable “banks” by pressing an INPUT SELECT button.

For example, pressing the [GUITAR/BASS/MIC2] INPUT SELECT button changes you to a guitar bank patch, and pressing [LINE] changes you to a line bank patch.

Banks are a collection of effect patches.

GTR:

Effect patches for use with guitars.

MIC:

Effect patches for use on the sound from the MIC input (i.e., vocals).

LIN (LINE):

Effect patches for use on the sound from CDs, MDs, and other external devices from the LINE input.

SML (SIMUL):

Effect patches for recording vocals and a guitar together.



“Effect Patches and Banks” (p. 84)

2. Press CURSOR [◀] [▶] to align the cursor up with the effect patch, and turn the TIME/VALUE dial to change the effect patch.

Preset patches (P)

The preset patches contain preset data. Their settings can be changed, but you cannot create a new preset patch.

User patches (U)

User patches can be rewritten, and are stored in internal memory. If you have created a patch that you would like to use for other songs as well, it is convenient to store it as a user patch.

Song patches (S)

Like user patches, song patches can be written; however, the data for song patches are stored along with the song data to the memory card. This is convenient when you have created a patch for a specific recorded performance, and would like to store that patch together with the song.

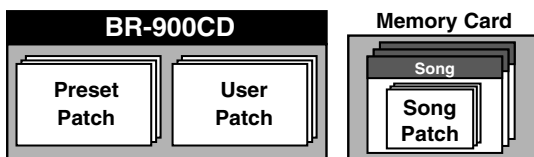

3. Press CURSOR [◀] [▶] to align the cursor up with the patch number, and turn the TIME/VALUE dial to change the patch number.
4. Press [EXIT] to return to the Play screen.



For more details regarding the use of insert effects, refer to “Using the Insert Effects” (p. 84).

MEMO

Some effect patches are particularly effective for stereo recording.

For recording in stereo, refer to “Selecting the recording track” (p. 39).



“Effect Patch List” (p. 202)

“Algorithm List” (p. 88)

Recording without insert effects

Press [EFFECTS] repeatedly to turn off the insert effects.

The indicator goes out, and the sound will be recorded without insert effects.

HINT

Selecting “INPUT <REC DRY>” as the point to which the insert effects are connected allows you to record the sounds without the insert effects while listening to the sounds with the insert effects applied.



“Changing How the Insert Effects are Used According to the Mode” (p. 87)

(6) Using the Rhythm

What is the Rhythm?

When you record, it is convenient to use the built-in Rhythm.

The “Rhythm” is a dedicated Rhythm track that can not only play back Rhythm sounds as a guide during recording, you can also use it to play internal Rhythm patterns and original user-created Rhythm patterns and to play and record these patterns as your own Rhythm part performances.

By using the Rhythm during recording, you can use the track editor to edit in units of measures, synchronize outputs with an external device, and perform other useful operations. For more details, refer to “Editing the Performance on a Track (Track Editing)” (p. 67) and “Synchronizing Playback with a MIDI Sequencer” (p. 158).

You can also change the tempo or Rhythm pattern during a song. For more details, refer to “Section 4 Using the Rhythm” (p. 119).

The Rhythm features two modes, “Pattern mode” and “Arrangement mode.”

Pattern Mode

You can perform patterns and create your own original patterns.

Arrangement Mode

You can perform arrangements and create your own original arrangements.

Patterns and arrangements are composed as shown below.

Pattern

These are drum performance phrases from one to several measures in length.

Internal patterns (preset patterns) include prepared patterns for intros, verses, fill-ins, and endings.

Arrangement

Patterns arranged in the order they are performed (for example, intro, verse, fill-in, and ending) and played at the selected tempo comprise a song.

Intro	Verse	Fill	Verse	Ending
-------	-------	------	-------	--------

MEMO

The Rhythm is preset with a wide variety of arrangements, including the sound of a normal metronome. For more details regarding the preset arrangements, refer to “Arrangement / Pattern List” (p. 206).

Playing the Rhythm

Each time you press [ARRANGE/PATTERN/OFF] of the Rhythm, the status changes as shown below.



ARRANGE: Lit (Arrangement Mode)

When you press [PLAY] to start playback or recording the Rhythm arrangement. When [STOP] is pressed, the Rhythm arrangement stops as well.

PATTERN: Flashing (Pattern Mode)

When you press [PLAY] to start playback or recording the Rhythm pattern. When [STOP] is pressed, the Rhythm pattern stops as well.

No sound plays if “BREAK” is selected for the pattern (p. 207).

OFF: Unlit

The Rhythm is turned off.

* When you adjust the volume of the Rhythm, use the Rhythm fader.

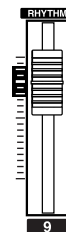

Changing arrangements

1. Press [ARRANGE/PATTERN/OFF] repeatedly until the indicator lights up.

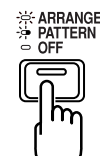

2. Select an arrangement.

Use CURSOR [◀] [▶] and the TIME/VALUE dial to select the Preset/Song and number.

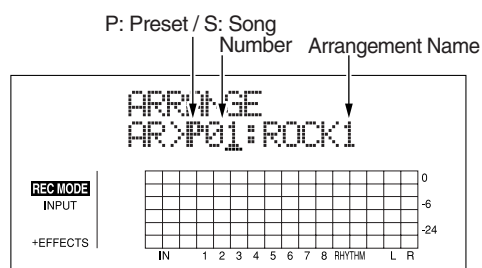

Preset Arrangements (P)

The preset arrangements contain preset data. Their settings cannot be changed, and you cannot create a new preset arrangement.

Song Arrangements (S)

Song arrangements can be written; however, the data for song arrangements are stored along with the song data to the memory card.

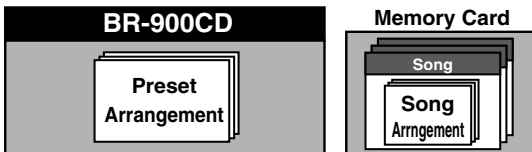

3. Press [EXIT] to return to the Play screen.

Changing patterns

1. Press [ARRANGE/PATTERN/OFF] repeatedly until the indicator is flashing.



2. Select a pattern.

Use CURSOR [◀] [▶] and the TIME/VALUE dial to select the Preset/Song and number.

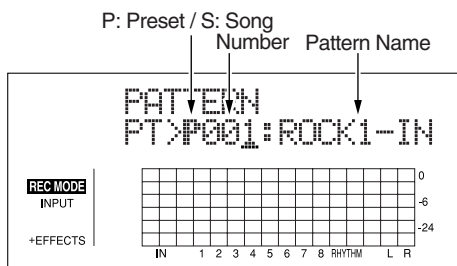

Preset Patterns (P)

The preset patterns contain preset data. Their settings cannot be changed, and you cannot create a new preset pattern.

Song Patterns (S)

Song patterns can be written; however, the data for song patterns are stored along with the song data to the memory card.



3. Press [EXIT] to return to the Play screen.

Changing the tempo of the arrangements or patterns

You can temporarily change the tempo of the arrangement or pattern being played by carrying out the following procedure while the Play screen is displayed.

* The arrangement's tempo setting is temporarily disabled.

1. Use [CURSOR] and align the cursor up with "TEMPO" in the display.
2. Rotate the VALUE dial to adjust the tempo.

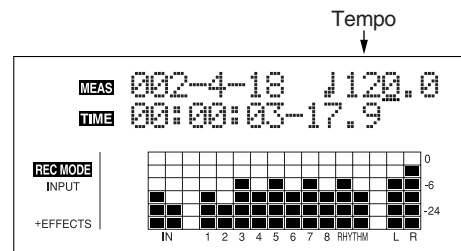

* The change in tempo is only temporary. If you want to change the arrangement's actual tempo, refer to "Changing the tempo of the arrangements or patterns" (p. 122).

* Tempos cannot be saved to patterns.

Tapping to change the tempo of the arrangements or patterns

You can temporarily change the tempo of the arrangement or pattern by the timing with which you press [TAP].

Tap on [TAP] four or more times to change the tempo of the arrangement or pattern. The tempo becomes that in which you tapped.

* The arrangement's tempo setting is temporarily disabled.



* The change in tempo is only temporary. If you want to change the arrangement's actual tempo, refer to "Changing the tempo of the arrangements or patterns" (p. 122).

* Tempos cannot be saved to patterns.

(7) Basic Recording

Selecting the recording track

1. Press either [1]–[7/8] at REC TRACK to select the recording track.

If the button flashes in red, that track is ready for recording.

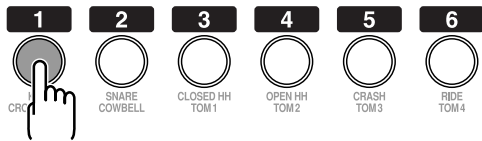

The status of each track can be determined from the indicator on the button.

Off: No recorded data exists on the track.

Green: Recorded data exists on the track.

Red: The track is selected for recording.

If a track with existing data is selected for recording, the indicator will light alternately in orange and green.

If INPUT SELECT [GUITAR/BASS/MIC2] or [MIC] are lit

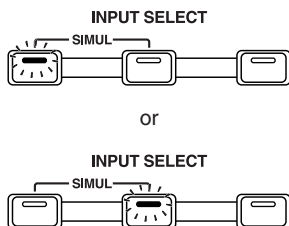

Since the input is mono, the recording is normally performed as a mono recording onto one track. Press one of TRACK [1]–[6] at REC TRACK to select the one track to which to record. However, if you want to record in stereo to increase the effect of insert effects, you can simultaneously press the [1] and [2], [3] and [4] or [5] and [6], REC TRACK buttons for stereo recording onto two tracks.

In addition, Tracks 7/8 are stereo tracks, so they always produce stereo recordings.

(Recording in Mono)

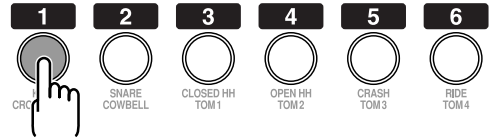

(Recording in Stereo)

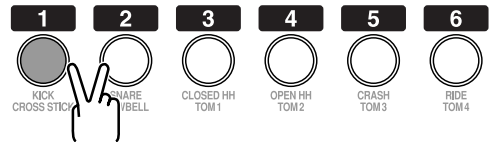

If INPUT SELECT [LINE] or [SIMUL] are lit

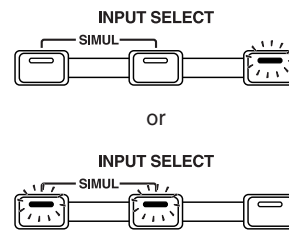

Since the input is stereo, the recording is normally performed on two tracks. Press either REC TRACK [1] or [2] to select tracks 1 and 2, or [3] or [4] to select tracks 3 and 4.

However, if you want to mix together the left and right channels being input onto one track, with tracks 1 and 2 selected, press REC TRACK [1] again to select track 1. Using the same procedure, you can select any track 1 to 6 to be the track to which to record.

In addition, Tracks 7/8 are stereo tracks, so they always produce stereo recordings.

About the recording (REC) modes

Recording on the BR-900CD is separated into three main modes.

Use whichever mode is suitable in the course of bringing your song to completion.

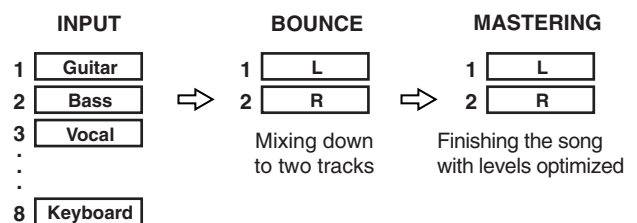

INPUT:

Only the instrument sounds or other input sources are recorded to the tracks. Sounds played back from other tracks are not recorded.

BOUNCE:

As the sounds on different tracks are played back, they are recorded together onto another track. In Bounce mode, you can play back eight tracks simultaneously and record them all to a single, separate V-Track.

When the input source is selected with INPUT SELECT, you can also include those sounds in the recording.

You can further include the sounds from the Rhythm in the recording as well.

You can also select the CD-R/RW drive as the recording destination (p. 59).

MASTERING:

Here, you apply the “Mastering Tool Kit” to the two tracks to which other tracks have been bounced to finish up with a song with levels (volume) optimized.

* *The Rhythm cannot be used in this mode.*

What is a Mastering Tool Kit?

When creating an audio CD from your recorded songs, or recording to an MD or similar media, the overall volume needs to be restrained, so that even the loudest portions of the songs are handled appropriately on the CD or MD. However, this often results in an overall lowering of the volume, resulting in a CD or MD that lacks excitement and impact. Moreover, in the low-frequency range, to which the human ear is not very sensitive, the sound actually produced might be perceived as being somewhat low in volume, even though the meter shows that it's at the maximum level. This also makes it difficult to create powerful sounds.

With the “Mastering Tool Kit,” however, you can smooth out the differences in volume that occur over the course of a song, while also correcting the balance in the low end.

We recommend mastering with the Mastering Tool Kit in the final stage of creating songs.



“Mastering” (p. 102)

“Mastering Tool Kit Patch List” (p. 205)

Procedure

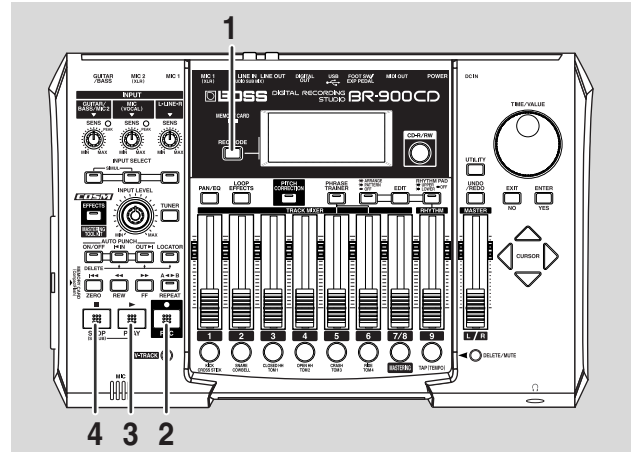

1. Press [REC MODE] repeatedly until “INPUT” is indicated for REC MODE at the left of the screen.

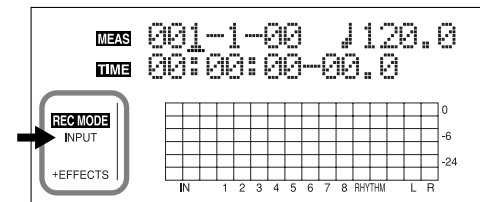

2. Press [REC].

[REC] flashes in red and the BR-900CD enters the recording standby state.

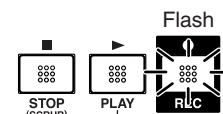

3. Press [PLAY].

The [REC] and REC TRACK buttons stop flashing in red and instead light solidly, and recording starts.

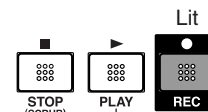

4. When you finish recording, press [STOP].

The REC TRACK button lights alternately in orange and green, indicating that track contains recorded data.

* *You cannot play back sounds recorded for less than one second.*

* *During updating, “Keep power on!” appears in the upper line of the display, while the lower line shows what is being processed.*

HINT

How the Tracks Are Organized

The BR-900CD features eight audio tracks that can be used for recording and playback. Tracks 1 through 6 are independent mono tracks. Tracks 7 and 8 are linked as stereo tracks.

Tracks 7 and 8 are fixed as left and right tracks, respectively, while fader movements, Loop Effects, and other processes are applied in common to both tracks. These two tracks thus make a convenient bounce destination (p. 58).

Tracks 7 and 8 also become dedicated mastering tracks during mastering (p. 102).

In addition to, and separate from the audio tracks, the BR-900CD also includes dedicated stereo tracks for playback of the internal rhythms (p. 37).

(8) Playing Back Recorded Music

1. Press [ZERO] to move to the time location 00:00:00-00.0.

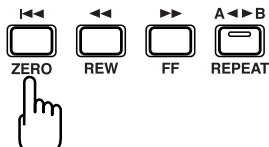

2. Press [PLAY].

Use the TRACK faders to adjust the volume separately for each track.

Silencing the sound of specific tracks (Track Mute)

During playback, hold down [DELETE/MUTE] and press a REC TRACK button that is lit in green and orange alternating or green.

The REC TRACK button will change to blinking in orange or green, and the sound of that track will be muted (silenced).

If you repeat the same operation, the button will return to its previous lit state and the sound of that track will once again be heard.

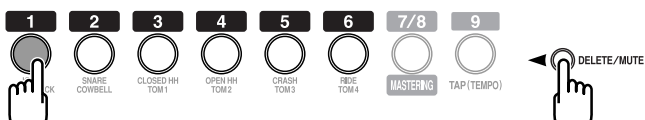
**(9) Overdubbing**

(Recording an additional performance while listening to an existing performance)

The tracks for which the REC TRACK button is lit in green (or alternately in orange and green) are tracks that already have data recorded on them.

The process of listening to a previously recorded performance while you record additional material on another track is called “overdubbing.” By recording the bass, guitar, and vocals on different tracks, you can then adjust the volumes of each instrument with respect to one another, change the left-right sound balance, exchange data, and perform other operations.

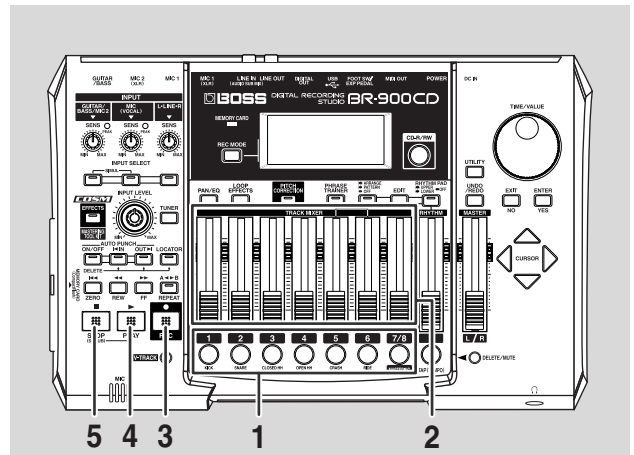

1. Press one of REC TRACK [1]–[7/8] to select the track to which to record.

By selecting a different track to record from the track that you previously recorded, you can record a new part while listening to the previously recorded part.

The status of each track can be determined from the indicator on the button.

Off: No recorded data exists on the track.

Green: Recorded data exists on the track.

Red: The track is selected for recording.

If a track with existing data is selected for recording, the indicator will light alternately in orange and green.

- * If you choose a track to record that already contains data (where the REC TRACK button is lit in green), the indicator lights alternately in orange and green, and the new music overwrites the previously recorded data.

2. Adjust the faders so the tracks being played back are at a suitable level.

3. Press [REC].

[REC] flashes in red and the BR-900CD enters the recording standby state.

4. Press [PLAY].

The [REC] and REC TRACK button indicators change from flashing in red to being continually lit and recording begins.

[PLAY] lights up.

Only what you are currently playing is recorded to the new track. The music that is being played back is not recorded.

- * If you use the INPUT LEVEL knob to turn down the volume of the input source during recording, the sound will be recorded in the audio track at a low volume, so that noise will be more apparent when you raise the volume of the audio track for playback. If you want to lower the sound of the input source that you are monitoring, lower the volume with the MASTER fader.

To change the volume of the music being played back, use the TRACK fader for the respective tracks.

5. When you finish recording, press [STOP].

- * You cannot play back sounds recorded for less than one second.

HINT

Some tips for overdubbing

When you record new material while listening to a recorded performance, your playing may tend to be buried in the existing performances, making it difficult for you to play. In this case, you can slightly lower the faders of the playback tracks, or pan the playback tracks to left (or right) and the sound you are playing to right (or left) to make it easier to hear yourself.



“Setting the positioning (pan) of the sound” (p. 42)

“Changing the Position of the Input Sound (Pan)” (p. 49)

(10) Adjusting the Sound for Each Track

You can adjust the tone, panning, and volume balance for each track individually.

Setting the positioning (pan) of the sound

1. Press [PAN/EQ].

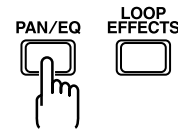

2. Press CURSOR [◀][▶] to move the cursor to “PAN,” and press [ENTER].

The Pan settings screen appears.

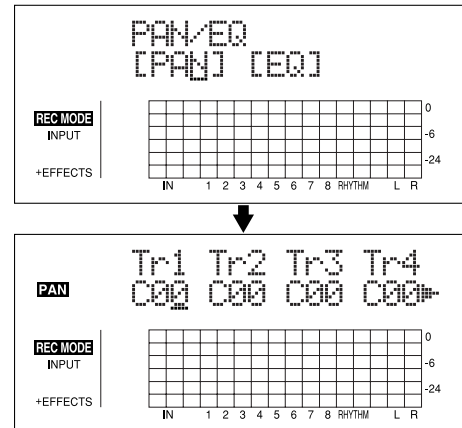

3. Press CURSOR [◀][▶] and turn the TIME/VALUE dial to change each track pan settings.

- * Pressing a REC TRACK button moves the cursor to the track corresponding to the button pressed.
- * Pressing [ENTER] sets this to “C00” (Center).

4. Press [EXIT] (or [PAN/EQ]) to return to the Play screen.

NOTE

Tracks 7 and 8 are stereo tracks, and any pan settings that are made apply to both of the tracks as a pair.

- When set to C00: Track 7 is panned left, and Track 8 is panned right.
- When set to L50: Both Track 7 and Track 8 are panned left.
- When set to R50: Both Track 7 and Track 8 are panned right.

Adjusting the tone (Track EQ)

“Track EQ” is an independent two-band equalizer featured on each track that allows you to adjust the high- and low-frequency tonal qualities separately.

1. Press [PAN/EQ].

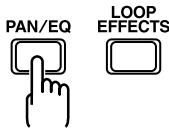

2. Press CURSOR [◀][▶] to move the cursor to “EQ,” and press [ENTER].

The EQ settings screen appears.

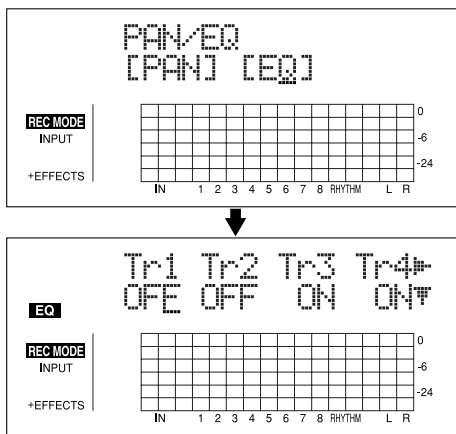

3. Press CURSOR [◀][▶] and turn the TIME/VALUE dial to turn each Track EQ on or off.

* Pressing a REC TRACK button moves the cursor to the track corresponding to the button pressed.

4. When changing the EQ settings, press CURSOR [▽] repeatedly to display the parameter screen, then use the [CURSOR] and the TIME/VALUE dial to change the setting's value.

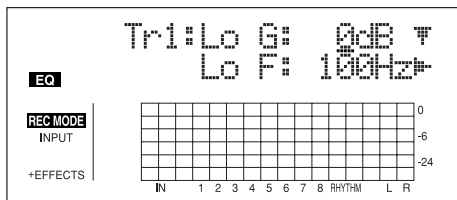

For more on the settings content, refer to “Track EQ Parameter Functions” (p. 112).

5. When you have finished making the settings, press [EXIT] (or [PAN/EQ]) to return to the Play screen.

Adding width to the sound (Loop Effect)

The BR-900CD features chorus, delay, and doubling (any one of these three can be selected at any one time) as loop effects, and includes reverb as well. Effective use of these allows you to add greater breadth to the sound.

What is a loop effect?

Effects connected to the send and return of mixer effects are called “loop effects.” You can adjust the depth of the effect by changing the send level of each mixer channel (equivalent to the tracks of the BR-900CD).

Since the send levels for each track are separate, you can change the depth individually. This allows you to, for example, have a deep reverb on the vocals and slight reverb on the drums, or any such combination.

Opposed to insert effects (p. 35), which are applied to specific sounds, loop effects are applied to the complete track.

* You cannot use chorus, delay, and doubling simultaneously. Any one may be selected while loop effects are in use.

1. Press [LOOP EFFECTS].

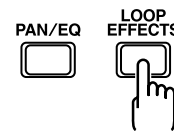

2. Press CURSOR [◀][▶] to move the cursor to “CHO/DLY” or “REV,” and press [ENTER].

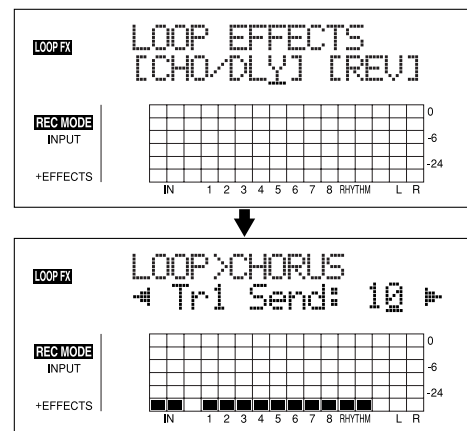

3. Press CURSOR [◀][▶] until “FX Type” or “Type” is displayed, then turn the TIME/VALUE dial to select the loop effect.

When using CHO/DLY

Select from "CHORUS," "DELAY," or "DBLN" (doubling).

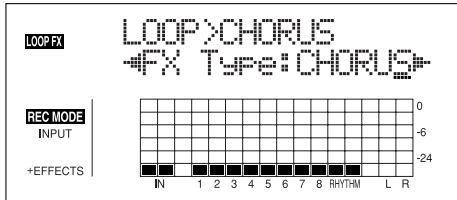

When using REV

Select from "HALL" or "ROOM."

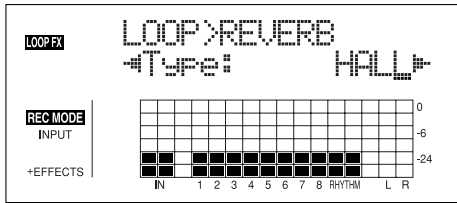

- If you want to change the settings for the selected effect, press CURSOR [◀] [▶] to select the parameter, then change the setting's value with the TIME/VALUE dial.

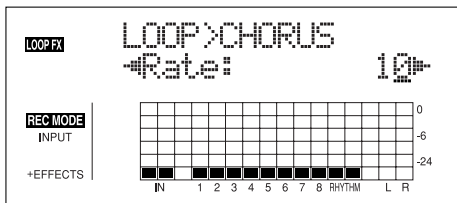

For more on the settings content, refer to "Loop Effect Parameter Functions" (p. 111).

- Press CURSOR [◀] [▶] to display the Send Level settings screen.

When using CHO/DLY

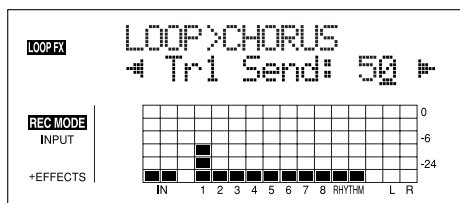

When using REV

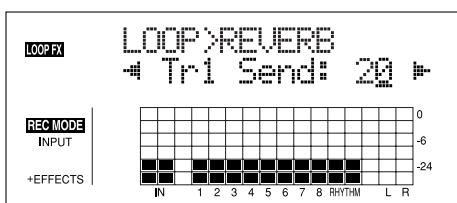

- Press CURSOR [◀] [▶] and the TIME/VALUE dial to adjust each track's send level.

* Pressing a REC TRACK button moves the cursor to the track corresponding to the button pressed.

The "send level" is the volume level of the signal sent from each respective track to each effect, and you can change the amount of effect applied by adjusting the send level.

The send level for each track is also indicated in the lower row of the display.

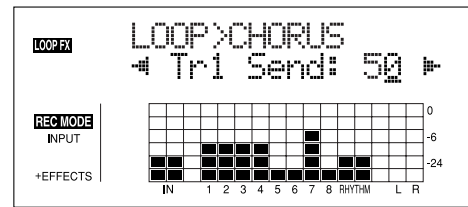

Send level of the each tracks

- After you have completed adjusting the send level, press [EXIT] repeatedly to return to the Play screen

MEMO

You can switch screens in the following sequence, with the screen cycling to the next screen each time [LOOP EFFECTS] is pressed.

Loop Effects selection screen → Send Level screen → Type screen → Play screen

(11) Bouncing (Putting multiple tracks together)

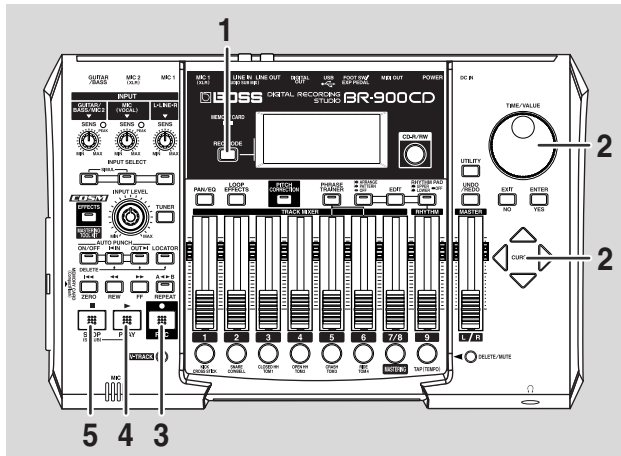

1. Press [REC MODE] repeatedly until "BOUNCE" is indicated for REC MODE at the left of the screen.

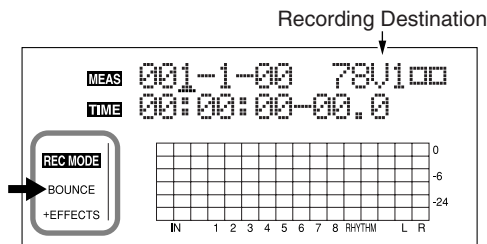

- : V-Tracks with recorded data.
- : V-Tracks without data.



"What are V-Tracks?" (p. 14)

2. Use CURSOR [◀|▶] and the TIME/VALUE dial to select the track/V-track to which you want to record.



You can also select the CD-R/RW drive as the recording destination. For more details, refer to "Bouncing Directly to a CD-R/RW Disc (Direct CD Bounce)" (p. 59).

3. Press [REC].

[REC] flashes in red and the BR-900CD enters the recording standby state.

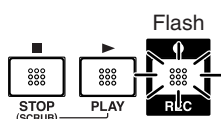

4. Press [PLAY].

The [REC] and REC TRACK buttons stop flashing in red and instead light solidly, and recording starts.

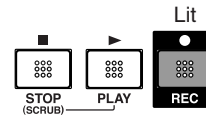

5. When you finish recording, press [STOP].

* During updating, "Keep power on!" appears in the upper line of the display, while the lower line shows what is being processed.



To prepare for further recording after the bouncing has been completed, the BR-900CD automatically switches to an empty V-Track at the bounce destination.



After bouncing down to two tracks, you can use the "Mastering Tool Kit" to eliminate discrepancies in volume levels throughout the song and to achieve the proper low-end balance. Refer to "Mastering" (p. 102).

(12) Turning Off the Power

To turn off the power, use the procedure described in "Turning Off the Power" (p. 28).



Before you turn off the BR-900CD, make sure to first stop any recording. If the BR-900CD is turned off during playback/recording where the memory card is being accessed, the recorded data, mixer settings, and effect patch data may be lost.

(13) Removing the Memory Card



The power of the BR-900CD must be turned off before removing a memory card. If a memory card is inserted when the power is turned on, the data in the memory card may be destroyed, or the memory card may become unusable.

Section 1

Recording

and

Playback

Recording

Selecting the Recording Track

1. Press either [1]–[7/8] at REC TRACK to select the recording track.

If the button flashes in red, that track is ready for recording.

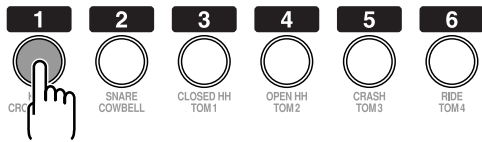

The status of each track can be determined from the indicator on the button.

Off: No recorded data exists on the track.

Green: Recorded data exists on track.

Red: The track is selected for recording.

If a track with existing data is selected for recording, the indicator will light alternately in orange and green.

If INPUT SELECT [GUITAR/BASS/MIC2] or [MIC] are lit

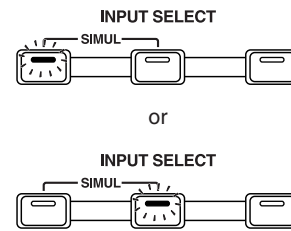

Since the input is mono, the recording is normally performed as a mono recording onto one track. Press one of TRACK [1]–[6] at REC TRACK to select the one track to which to record.

However, if you want to record in stereo to increase the effect of insert effects, you can simultaneously press the [1] and [2], [3] and [4], or [5] and [6], REC TRACK buttons for stereo recording onto two tracks.

In addition, Tracks 7/8 are stereo tracks, so they always produce stereo recordings.

(Recording in Mono)

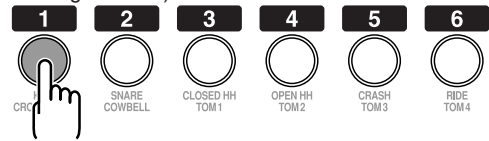

(Recording in Stereo)

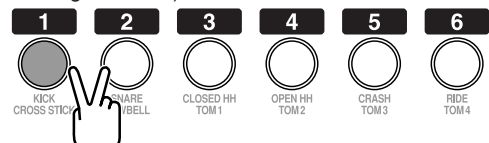

If INPUT SELECT [LINE] or [SIMUL] are lit

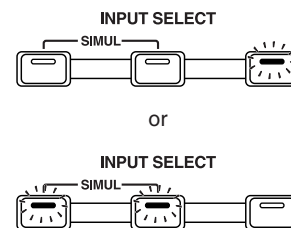

Since the input is stereo, the recording is normally performed on two tracks. Press either REC TRACK [1] or [2] to select tracks 1 and 2, or [3] or [4] to select tracks 3 and 4.

However, if you want to mix together the left and right channels being input onto one track, with tracks 1 and 2 selected, press REC TRACK [1] again to select track 1. Using the same procedure, you can select any track 1 to 6 to be the track to which to record.

In addition, Tracks 7/8 are stereo tracks, so they always produce stereo recordings.

Changing V-Tracks

The BR-900CD is an eight-track multitrack recorder, and each track consists of eight V-Tracks. You can select any one of these V-Tracks for recording or playback.

Therefore, by making use of the many V-Tracks, you can use the BR-900CD just as if it were a 64-track multitrack recorder.

This allows a wide range of uses, such as recording one take of a guitar solo or vocal, and then recording another take without having to erase the first one. You can also then take just the portions of the V-Tracks that you like and put them together onto one track.



“Editing the Performance on a Track (Track Editing)” (p. 67)

1. Press [V-TRACK].



The V-Track Selection screen appears. This screen shows the numbers of the selected V-Tracks for each track.

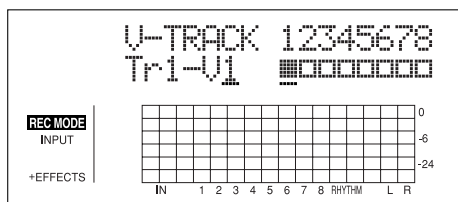

■ : V-Tracks with recorded data.

□ : V-Tracks without data.

2. Use the REC TRACK [1]–[7/8] to select the track to be altered.

* You can also select tracks with CURSOR [◀] [▶].

3. Turn the TIME/VALUE dial and change the V-Track.
4. After you finish changing the V-Track, press [V-TRACK] (or [EXIT]) to return to the Play screen.

Changing the Position of the Input Sound (Pan)

When you record new material while listening to a recorded performance, your playing may tend to be buried in the existing performances, making it difficult for you to play.

If this is the case, you can change the positioning (or panning) of the INPUT (the instrument you are playing) and record it so that it is not buried underneath the other sounds.

1. Press [PAN/EQ].
2. Press CURSOR [◀] [▶] to move the cursor to “PAN,” and press [ENTER].

The PAN settings screen appears.

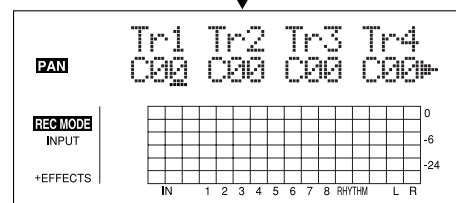
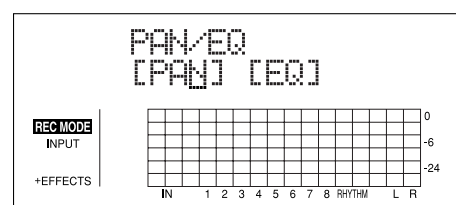

3. Press CURSOR [◀] to display “IN.”

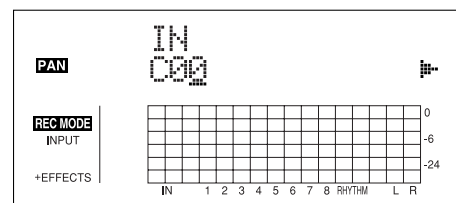

4. Turn the TIME/VALUE dial to change the pan settings.
The pan settings made here are automatically applied to the track that you are recording to, so that after recording is complete, you can listen to the track with the same pan as that when it was recorded.
5. Press [PAN/EQ] (or [EXIT]) to return to the Play screen.

HINT

Pan the playback tracks to left (or right) and the sound you are playing to right (or left) to make it easier to hear yourself.

Recording Operations

1. Press [REC MODE] repeatedly until "INPUT" is indicated for REC MODE at the left of the screen.

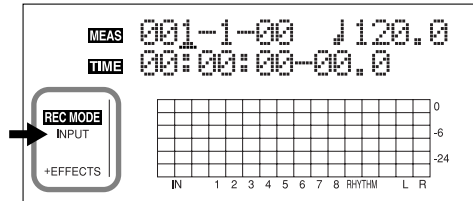

2. Press [REC].

[REC] flashes in red and the BR-900CD enters the recording standby state.

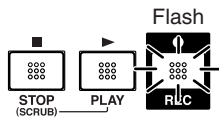

3. Press [PLAY].

The [REC] and REC TRACK buttons stop flashing in red and instead light solidly, and recording starts.

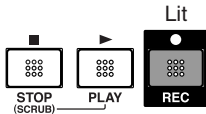

4. When you finish recording, press [STOP].

The REC TRACK button lights alternately in orange and green, indicating that track contains recorded data.

- * You cannot play back sounds recorded for less than one second.
- * During updating, "Keep power on!" appears in the upper line of the display, while the lower line shows what is being processed.

* The following operations cannot be used, or are disabled, while the recorder is in use (during recording and playback).

- Recording patterns
- Editing arrangements
- Selecting drum kits
- Switching to the USB screen
- Switching to the Tone Load screen
- Switching to the Song Selection screen
- Switching to the Song New screen
- Switching to the Song Information screen
- Switching to the Edit Song screen
- Track Editing
- Switching to the Sync screen
- Switching to the Initialize screen
- Operating the CD-R/RW

Repeating Playback (Repeat)

By using the “Repeat function” you can repeatedly play back a specified part. Repeating playback allows you to check the mixing balance or perform loop recordings (p. 56) with the punch in/out functions.

The position in the song where [REPEAT] is pressed first becomes repeat start point (A), and the position where it is pressed a second time becomes repeat end point (B). The portion between the two points is then repeated during playback.

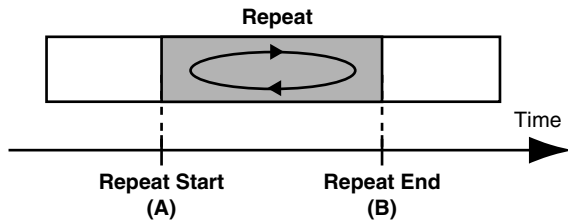

Press [REPEAT] again to cancel the repeat function and delete the start and stop points.

Setting the Repeat Portion

1. Enter the repeat start point (A).

Move to the position where you want the repeat to start and press [REPEAT].

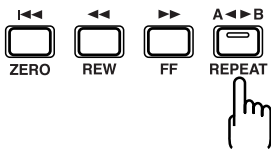

The position is set as repeat start point (A).

The [REPEAT] indicator begins to flash, telling you that the repeat start point (A) has been registered.

If you wish to re-do the registration, you can cancel the registered location by pressing [REPEAT] when the current location is the same as the repeat start point (A).

If the current location is beyond the repeat start point (A), press [REPEAT] twice to cancel the registration.

The [REPEAT] indicator goes out, and the registered repeat start point (A) and end point (B) are deleted.

2. After registering the repeat start point (A), register the repeat end point (B).

Move to the position where you want the repeat to end and press [REPEAT].

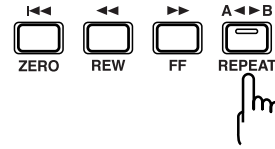

That position becomes repeat end point (B).

The [REPEAT] indicator lights, telling you that the repeat end point (B) has been registered.

To re-do the registration, press [REPEAT] once again.

The [REPEAT] indicator goes out, and the registered repeat start point (A) and end point (B) are deleted.

Then press [REPEAT] again and register repeat start point (A) and end point (B) as desired.

* There must be at least one second between repeat start point (A) and repeat end point (B). It is not possible to set the end point less than one second away from the start point.

* If you press [REPEAT] at a position before the repeat start point (A), that earlier position is then set as the repeat start point (A).

3. If you want to save the settings in the currently selected song, hold down [STOP], and press [REC].



“Saving the Current Settings to the Song (Song Save)” (p. 79)

* During updating, “Keep power on!” appears in the upper line of the display, while the lower line shows what is being processed.

Setting the Repeat Portion with Accurate Timing

Normally, the repeat start and end points are registered at the exact position where [REPEAT] is pressed. This may make it difficult for you to set the repeat portion exactly as you desire.

If this is the case, you can use the quantize function to have the time [REPEAT] is pressed be adjusted to the timing of the song.

The quantize function allows you to set the timing in one-measure units.

Perform the procedure given below to use the quantize function.

1. Press [UTILITY].
2. Press CURSOR [◀] [▶] to move the cursor to "SYS," and press [ENTER].

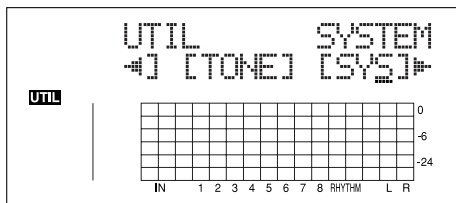

3. Press CURSOR [◀] [▶] to select "AB Qtz," and turn the TIME/VALUE dial to turn the setting on.

When off, the quantize function will not work.

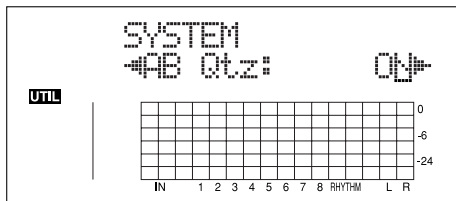

4. Press [UTILITY] (or press [EXIT] repeatedly) to return to the Play screen.

- * During updating, "Keep power on!" appears in the upper line of the display, while the lower line shows what is being processed.
- * Changing the tempo after having made the quantize function settings in a repeated portion will result in timing discrepancies between the repeat start and end points and the beginnings and ends of measures.
- * You can set the repeat portion to one measure by pressing [REPEAT] twice at the same position.

HINT

When the repeat portion is set, you can use the following functions to edit your recorded track data.

- Copying the repeat portion (p. 67)
- Moving the repeat portion (p. 70)
- Erasing the repeat portion (p. 73)

Before using these functions, you can use the quantize function to set the repeat portion with accurate timing.

Re-recording Only a Mistake (Punch-in/out)

You may occasionally make a mistake while recording, or the performance may not turn out as you expect. In this case, you can punch in/out to re-record only the portion that is mistaken.

Changing to recording during the playback of a song is referred to as **punching in**, and changing from recording to playback is referred to as **punching out**.

Therefore, punch in at the location where you want to begin the re-recording, and punch out at the location where you want the re-recording to end.

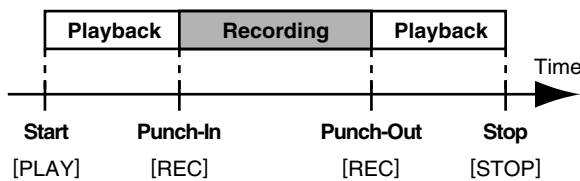

With your BR-900CD, you can choose from manual or automatic punching in/out.

- * You can use the Undo function (p. 57) to revert to the condition before re-recording.
- * The data prior to punch-in/out will remain on the memory card without being erased. If this data is no longer needed, in order to use the memory card effectively, use the song optimize function (p. 78) to delete unneeded data from the memory card.

Manually Punching In/Out

You can use the button on the BR-900CD or a foot switch to punch in or out.

When you are playing an instrument and performing the recording by yourself, it may be difficult to punch in or out using the button on the BR-900CD. If this is the case, you can use a separately sold foot-switch (BOSS FS-5U, Roland DP-2, etc.) and use your feet to punch in and out.

- * When using manual punch-in/out, you need to allow for an interval of at least one second between the punch-in and punch-out points.

Manually punching in and out using [REC]

As an example of use, the explanation below assumes you are manually punching in and out to re-record a portion of track 1, which is a track to which you have already recorded.

1. Press REC TRACK [1].
REC TRACK [1] lights alternately in orange and green.
2. Place the fader for track 1 at the location shown below.

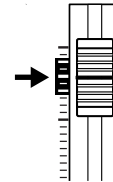

3. Start playback and adjust the volume of the input source using the INPUT LEVEL knob.
Listen to the track you will be re-recording and the input source and adjust the volume of the input source using the INPUT LEVEL knob so that it is the same level as the track.
4. Move to a position before where you want to start re-recording and press [PLAY] to start playback.
5. Press [REC] to punch in at the location where you want to start recording.
The BR-900CD starts recording.
6. To punch out, press [REC] (or [PLAY]) again.
Each time you press [REC], you punch in and punch out, so if there is another location that you want to redo, then you can punch in again at that location using the same procedure.
7. Press [STOP] to stop recording.
* During updating, "Keep power on!" appears in the upper line of the display, while the lower line shows what is being processed.
8. Listen to the re-recorded results.
Return the song to a point earlier than you re-recorded, and play it back.
Adjust the volume of track 1 using the TRACK fader.

Manually punching in and out using a foot switch

MEMO

In operating the foot switch during playback of a song (manual patch in and out), press the foot switch once to punch in, then press it again to punch out.

In order to use a foot switch

When you are using a foot switch (BOSS FS-5U, Roland DP-2, etc.) to punch in and out, connect the foot switch to the FOOT SW jack on the BR-900CD and change the function of the FOOT SW jack by following the procedure given below.

1. Press [UTILITY].
2. Press CURSOR [◀] [▶] to move the cursor to "SYS," and press [ENTER].

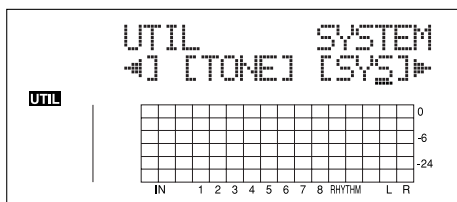

3. Press CURSOR [◀] [▶] and select "Foot SW."

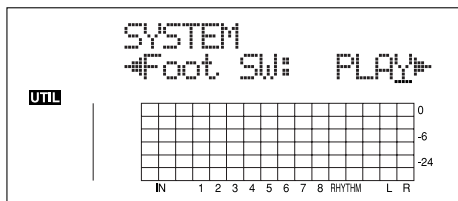

4. Turn the TIME/VALUE dial and select "PUNCH" (PUNCH IN/OUT).
5. Press [UTILITY] (or press [EXIT] repeatedly) to return to the Play screen.

* During updating, "Keep power on!" appears in the upper line of the display, while the lower line shows what is being processed.

Auto Punching In and Out

Automatically punching in and out at predetermined locations (or times) in the song is referred to as "auto punching in/out."

When you want to punch in and out at accurate times or when you want to concentrate on playing rather than punching in and out manually, the auto punch in/out function is very useful.

Specifying the area for auto punching in/out

Before you begin recording, you must register the locations at which punch-in and punch-out will occur automatically.

1. Register the location where you want to punch in.

Move the location where you want to punch in and press AUTO PUNCH [IN] to register that location for automatic punch in.

At this time, the AUTO PUNCH [IN] indicator lights, telling you that the punch-in position is registered.

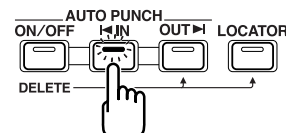

* If the AUTO PUNCH [IN] indicator is lit, you will automatically move to the registered punch-in time when this button is pressed.

2. Register the location where you want to punch out.

Move the location where you want to punch out and press AUTO PUNCH [OUT] to register that location for automatic punch out.

At this time, the AUTO PUNCH [OUT] indicator lights, telling you that the punch-out position is registered.

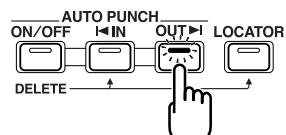

* If the AUTO PUNCH [OUT] indicator is lit, you will automatically move to the registered punch-out time when this button is pressed.

MEMO

If you want to punch in/out at a previously set locator point, press [LOCATOR] to move to the locator point (p. 64), and press AUTO PUNCH [IN] or AUTO PUNCH [OUT].

Erasing a registered auto punch in/out location

- To erase an auto punch-in location, press and hold AUTO PUNCH [ON/OFF] and then press [IN].
- To erase an auto punch-out location, press and hold AUTO PUNCH [ON/OFF] and then press [OUT].

When the settings are erased, the AUTO PUNCH [ON/OFF], [IN], and [OUT] indicators go out.

- * If you want to save the auto punch in/out settings in the currently selected song, hold down [STOP], and press [REC].
- * During updating, "Keep power on!" appears in the upper line of the display, while the lower line shows what is being processed.

How to record

As an example of use, the explanation below assumes you are using the auto punch in/out to re-record a portion of track 1, which is a track to which you have already recorded.

1. Press REC TRACK [1].

REC TRACK [1] lights alternately in orange and green.

2. Place the fader for track 1 at the location shown below.

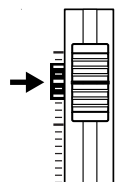

3. Make sure that the AUTO PUNCH [ON/OFF] indicator is dark.

If it is lit, press AUTO PUNCH [ON/OFF] to make the indicator go dark.

4. Start playback and adjust the volume of the input source using the INPUT LEVEL knob.

Listen to the track you will be re-recording and the input source and adjust the volume of the input source using the INPUT LEVEL knob so that it is the same level as the track.

5. Move to a position before where you want to start re-recording and press AUTO PUNCH [ON/OFF].

The indicator lights up, showing that the auto punch in and out have been set.

6. Press [REC] to place the BR-900CD in recording standby and then press [PLAY].

Recording automatically starts at the auto punch-in location, so start playing what you want to record.

At the point you specified for punch-out, the track will automatically change back to play mode.

7. Press [STOP] to stop recording.

- * During updating, "Keep power on!" appears in the upper line of the display, while the lower line shows what is being processed.

8. Listen to the re-recorded results.

Return the song to a point earlier than you re-recorded, and play it back.

Adjust the volume of track 1 using the TRACK fader.

Repeatedly Recording Over the Same Location (Loop Recording)

The repeat function (p. 51) allows you to play a certain portion of a song (the loop portion) over and over again. If you used auto punch in/out together with the repeat function, the portion will be repeated so the result of the recording can be heard right away.

If the recording did not sound as you wished, simply press [REC] and redo the recording.

Using the repeat function and auto punch in/out together in this manner to repeatedly perform recording is known as "loop recording."

* For details on how to set the portion where recording will occur (the portion between the punch-in and punch-out positions), refer to "Auto punching in and out" above.

Setting the portion to be repeated

Before you begin recording, you will need to set the starting and ending position of the portion to be repeated.

* The portion to be repeated should contain the portion that you wish to re-record (the portion between the punch-in and punch-out points).

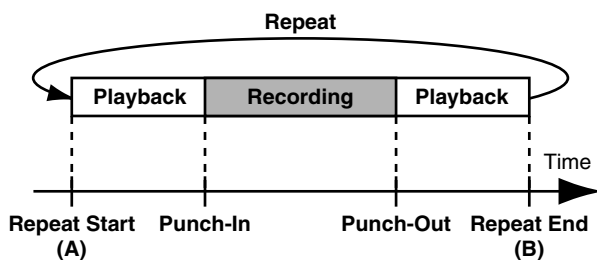

If the portion to be re-recorded is not fully contained in the repeat portion, the recording may not start or end as desired.

How to record

As an example of use, the explanation below assumes you are using the auto punch in/out to re-record a portion of track 1, which is a track to which you have already recorded.

1. Press **REC TRACK [1]**.
REC TRACK [1] lights alternately in orange and green.
2. Place the fader for track 1 at the location shown below.

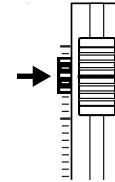

3. Use the repeat function (p. 51) to repeat the playback of the song and adjust the volume of the input source using the **INPUT LEVEL** knob.

Listen to the track you will be re-recording and the input source and adjust the volume of the input source so that it is the same level as the track.

4. Press **[STOP]**.
5. Press **AUTO PUNCH [ON/OFF]**.
The indicator lights, showing that the auto punch in and out have been set.
6. When you are ready to record, press **[REC]**, then press **[PLAY]** to begin recording.

After you press [PLAY], you can record from the time the first punch-in is reached until the time the punch-out is reached. Re-record the portion as desired.

When the song is repeated, you can check the result of what you just recorded. If the recording is not satisfactory, press [REC] and perform the recording again.

7. Press **[STOP]** to stop recording.
* During updating, "Keep power on!" appears in the upper line of the display, while the lower line shows what is being processed.
8. Press **[REPEAT]** to make the button indicator go dark.
9. Press **AUTO PUNCH [ON/OFF]** to make the indicator go dark.

Canceling an Operation (Undo/Redo)

Occasionally when the recording you make may not turn out as you wish, or the settings you make for an editing operation are incorrect, and you want to reverse what you have done. At these times, you can use the “Undo function.”

The Undo function reverses the action you have just performed and returns you to the status you were in beforehand. To reverse an Undo, you must use the “Redo function.”

For example, suppose you are punching in to loop record and record over the same location twice. To undo the recording you just performed and return to the first recording, you would use the Undo function.

To then reverse the Undo and return to the condition that you were in immediately after the second recording, you would use the Redo function.

- * After you have performed an Undo, you can only perform a Redo (you cannot perform an Undo again).
- * If you record something, or carry out Track Edit after performing an Undo, it will no longer be possible to perform a Redo.
- * Undos only affect audio data recorded to the tracks. You cannot undo changes made to parameter settings, or data other than audio data.
- * Keep in mind that the history of all operations you’ve carried out with respect to the recorded data will be cleared as soon as you carry out a Song Optimize (p. 78). This means that once you execute Song Optimize, you’ll no longer be able to perform an undo.

Reversing the Last Operation (Undo)

1. Press [UNDO/REDO].

“UNDO?” appears.

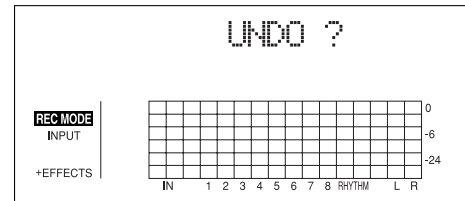

2. To execute Undo, press [ENTER] (YES).

Press [ENTER] to reverse the last performed recording or editing operation.

If you decide not to Undo, press [EXIT] (NO).

Canceling the Undo (Redo)

To reverse the Undo you just executed, perform a Redo.

1. Press [UNDO/REDO].

“REDO?” appears.

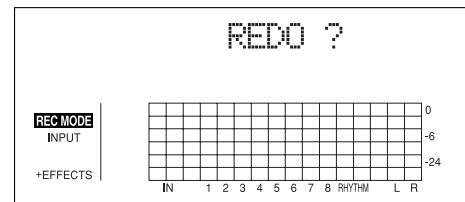

2. To execute Redo, press [ENTER] (YES).

The Undo you just performed is reversed.

If you decide not to Redo, press [EXIT] (NO).

Putting Multiple Tracks Together (Bounce)

Although the BR-900CD allows the simultaneous playback of eight tracks, when you run out of tracks, the BR-900CD also lets you copy the recordings of multiple tracks together onto one track (V-Track). This is called “bounce” (also known as bounce recording or ping-pong recording). By combining multiple tracks in this way, you can free up other tracks in order to record additional performances.

HINT

In bounce mode, you can play back eight tracks simultaneously and record them all to a single, separate V-Track.

When input sources are selected with INPUT SELECT, you can have those sounds recorded together.

Furthermore, you can include the sounds from the Rhythm in the recording.

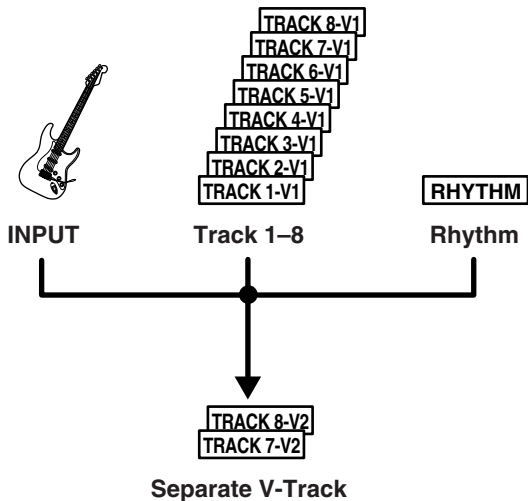

The explanation below uses an example of mixing the monaural recording on tracks 1 and 2 and the stereo recording on tracks 3 and 4, and bouncing them to V-Track 2 of tracks 3 and 4.

1. Set the pan for tracks 1 and 2 to the locations you desire, set the pan for track 3 all the way to the left (L50), and the pan for track 4 all the way to the right (R50).



“Setting the positioning (pan) of the sound” (p. 42)

2. Play back the song and adjust the volumes for the tracks 1 to 4 using the REC TRACK faders.

The overall volume is adjusted by the MASTER fader. At this time, raise the volume as high as possible without allowing the sound to distort.

Lower the faders for the tracks that you do not want to mix.

- * When using bounce recording, you can record the sounds with insert effects (p. 84), loop effects (p. 108), Track EQ (p. 110), or Pitch Correction (p. 114) applied. When using the insert effects, refer to “Changing How the Insert Effects are Used According to the Mode” (p. 87).

3. Press [STOP].

4. Press [REC MODE] repeatedly until “BOUNCE” is indicated for REC MODE at the left of the screen.

The INPUT SELECT indicator goes out, and the input source is automatically muted. This prevents the input source from being mixed in and recorded during bounce recording.

- * If you wish to mix an input source as part of the bounce recording, press [INPUT SELECT] to select the desired input source. At this time, you can apply loop effects (p. 108) to the sound of the input source.

5. If you want to mix in the sound of the Rhythm as well, increase the Rhythm fader.

If you do not want to record the Rhythm, lower the fader.

6. Use CURSOR [◀] [▶] and the TIME/VALUE dial to select the recording-destination track/V-Track. Here, set this to "34V2" (V-Track 2 of Tracks 3 and 4).

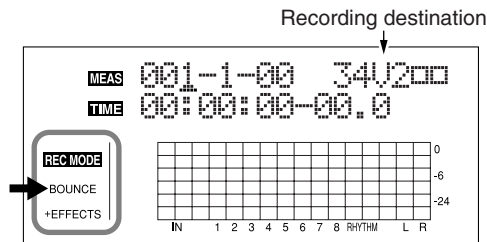

- : V-Tracks with recorded data.
- : V-Tracks without data.

(When bouncing while recording in mono)

If you turn the TIME/VALUE dial at this time, the screen for specifying the track for mono recording is displayed.

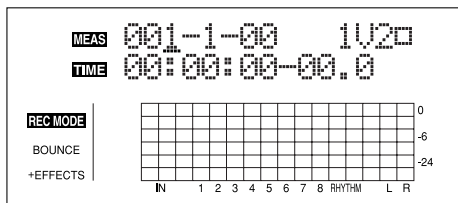

7. After pressing [ZERO] to return to the time location 00:00:00-00.0, press [REC] and then press [PLAY] to start bounce recording.
8. When you are finished recording, press [STOP].
- * During updating, "Keep power on!" appears in the upper line of the display, while the lower line shows what is being processed.
9. Lower all TRACK faders except those for Tracks 3 and 4, press [PLAY], and then check the sounds bounced to Tracks 3 and 4.
- * The pan for tracks 3 and 4, where the music was bounced, is set all the way to the left and right respectively.
10. If you want to save the settings in the currently selected song, hold down [STOP], and press [REC].
- * During updating, "Keep power on!" appears in the upper line of the display, while the lower line shows what is being processed.

Bouncing Directly to a CD-R/RW Disc (Direct CD Bounce)

With the BR-900CD, you can bounce data directly to a CD-R/RW disc instead of the audio tracks. This is a convenient way to keep a copy of song sketches after recording them.

NOTE

- The Rhythm and Tone Load functions cannot be used when tracks are bounced directly to a CD. Only the audio tracks are bounced.
- Due to differences in the characteristics of CD-R/RW discs, there is no way to ensure 100% error-free writing. For this reason, the bouncing may be discontinued if an error occurs in writing to the CD-R/RW disc. Never use this feature with your important recordings.

1. Prepare a blank CD-R/RW disc or a CD-R/RW disc to which data has been written on the BR-900CD, but that is not yet finalized (p. 143).
2. Place the CD-R/RW disc in the tray. The CD-R/RW drive's indicator begins flashing. Wait until the indicator stops flashing.
3. Press [REC MODE] a number of times until the BOUNCE indicator lights. The BR-900CD is switched to BOUNCE mode.

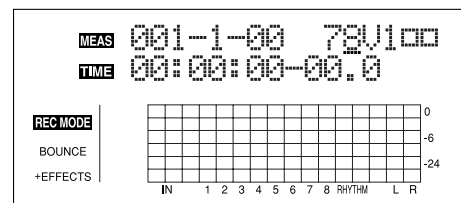

4. Use CURSOR [◀] [▶] and the TIME/VALUE dial to select "CD."

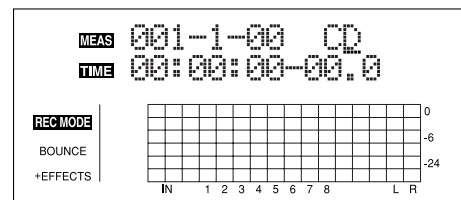

- * If you wish to mix an input source as part of the bounce recording, press [INPUT SELECT] to select the desired input source. See "Selecting the Input Source and Bouncing the Recording to a CD-R/RW" (p. 60).

5. Press [REC].

The CD-R/RW drive's motor begins spinning.

"Now Checking..." appears in the display.

The message disappears approximately ten seconds later, indicating that preparations for bouncing have been completed.

NOTE

- In contrast to normal recording, you cannot press [REC] (manual punch in) after first pressing [PLAY].
- The moment [REC] is pressed, a region with a minimum of one song is created on the disc. Note that even if you press [STOP] at this point without bouncing any tracks, the song cannot be deleted.

6. Press [PLAY].

[PLAY] and [REC] light, and bouncing to the CD-R/RW disc begins.

The sounds are written to the CD-R/RW disc exactly as they are played back.

7. Press [STOP] when you reach the end of the song.

"Keep power on! Closing Track..." appears in the display. The message disappears, indicating that the bouncing have been completed.

Several seconds may be necessary before you can proceed with the next operation.

8. To check the results of the bouncing, play the disc back as an audio CD (p. 142).

9. To enable playback of the bounced tracks on a conventional audio CD player, finalize the disc (p. 143).

NOTE

Finalizing the CD-R/RW disc allows the content to be heard using a regular CD player but prevents any further bouncing or writing of tracks to the disc. Do not finalize the disc if you want to bounce or write other tracks to it.

Selecting the Input Source and Bouncing the Recording to a CD-R/RW

You can simultaneously select the input source sounds and record when bouncing directly to a CD, just as you can when bouncing tracks in the normal manner.

1. Carry out Steps 1–4 in "Bouncing Directly to a CD-R/RW Disc (Direct CD Bounce)" (p. 59).

2. Press one of the INPUT SELECT buttons to select the input source you want.

The button for the selected input source lights up, and the sounds of the input source become audible.

3. Carry out Step 5 and the subsequent steps in "Bouncing Directly to a CD-R/RW Disc (Direct CD Bounce)" (p. 59)

The input source sound is mixed with the sounds played back from the tracks and bounced to the CD-R/RW disc.

MEMO

You can also bounce only the input source sound to the CD by completely lowering track faders 1–6 and 7/8 and the RHYTHM faders.

Loading Songs Created with the BR-864/BR-532

You can load songs created with the BR-864 or BR-532 into the BR-900CD via memory cards.

Loading Songs Created with the BR-864

First, save the song data created with the BR-864 to a memory card, then insert the memory card into the BR-900CD.

NOTE

Once you record, edit, or set parameters for imported BR-864 song data, that particular song data can no longer be used by the BR-864.

To protect against accidental recording or editing, song protect (p. 79) is automatically switched on for imported BR-864 song data.

If you can accept the fact that you will no longer be able to use the song data with the BR-864, you can switch song protect off, then carry out recording or editing.

1. Press [UTILITY].
2. Press CURSOR [◀] [▶] to move the cursor to "SEL," and press [ENTER].
The Song Select screen is appeared.
The song protect icon (🔒) is indicated for the BR-864 songs.

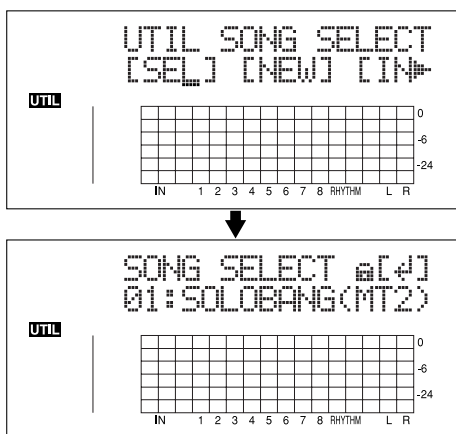

3. Rotate the TIME/VALUE dial to select the song to be loaded.
4. Press [ENTER].
The song data is loaded.

NOTE

Patches employing the "Guitar Synth" algorithm of the BR-864 are replaced by "P001" when loaded.

The "Harmonist" of the BR-864 are replaced by "Flanger" when loaded.

MEMO

To record or edit, turn off song protect (p. 79).

When you turn off song protect, "Overwrite OK?" appears in the display; press [ENTER] (YES). Song protect is switched off, and the data is simultaneously converted to BR-900CD format. After this step is executed, the song data can no longer be used with the BR-864.

Loading Songs Created with the BR-532

When copying song data created with the BR-532 from SmartMedia to a BR-900CD memory card, you can load the data as a BR-900CD song.

NOTE

Reading BR-532 data requires a PC with a SmartMedia reader and CompactFlash writer connected.

First, copy the data on the BR-532 memory card (SmartMedia) to the PC with the SmartMedia reader, and use the CompactFlash writer to copy that data from the PC to a BR-900CD memory card.

Then insert the memory card containing the copy of the desired data into the BR-900CD.

1. Press [UTILITY].
2. Press CURSOR [◀] [▶] to move the cursor to "SEL," and press [ENTER].
The Song Select screen is appeared.

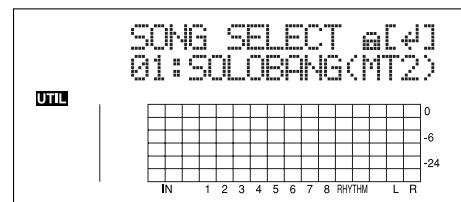

3. Rotate the TIME/VALUE dial to select the song to be loaded.
4. Press [ENTER].
The song data is loaded.

NOTE

The data remains in BR-532 format immediately after loading. Once the loaded song is saved, the data is converted (p. 79) to BR-900CD format.

Displaying the Song Information

Displaying the Remaining Available Recording Time

Follow the procedure below to either display the elapsed recording time in the recording standby and recording screens.

1. Press [UTILITY].
2. Press CURSOR [◀][▶] to move the cursor to "SYS," and press [ENTER].

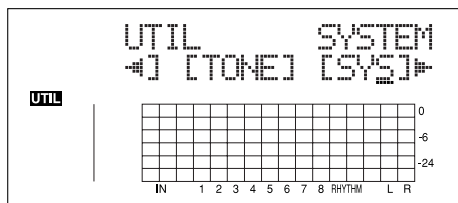

3. Press CURSOR [◀][▶] to select "Remain Inf," and turn the TIME/VALUE dial to select "ON."

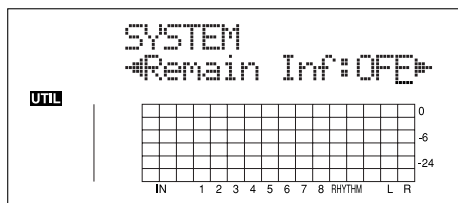

ON: Displays the remaining available recording time in "minutes: seconds."

OFF: Doesn't display the remaining available recording time.

4. Press [UTILITY] (or press [EXIT] repeatedly) to return to the Play screen.

* During updating, "Keep power on!" appears in the upper line of the display, while the lower line shows what is being processed.

* When [REC] is pressed in the Play screen, putting the BR-900CD into record standby ([REC] flashes), the remaining recording time is displayed in the TIME area.

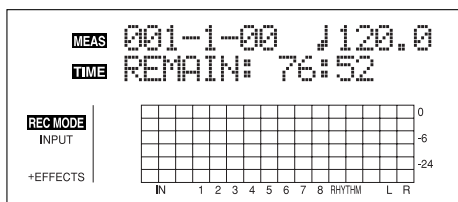

Displaying the Memory Card Usage

Follow the procedure below to display the current condition of the memory card being used.

1. Press [UTILITY].
2. Press CURSOR [◀][▶] to move the cursor to "INF," and press [ENTER].

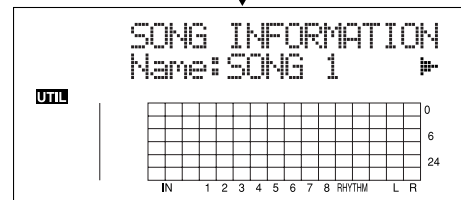
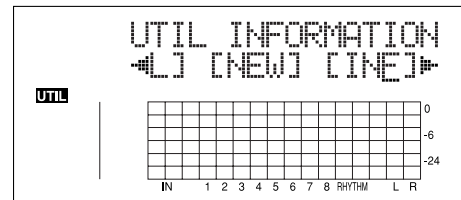

3. Press CURSOR [◀][▶] to select the parameter to be displayed.

Name of the currently selected song

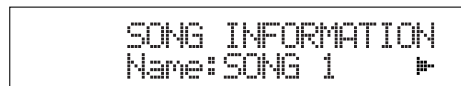

Song's data type and memory used (Size: MB)

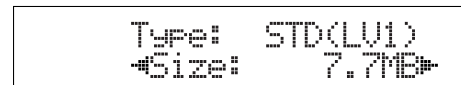

Data Type

HiFi (MT2): High-quality recording type

STD (LV1): Standard recording type

LONG (LV2): Long recording type

Remaining memory



* The song sizes are displayed in units of 1M = 1,000,000 bytes. The size displayed is an approximation.

4. Press [UTILITY] (or press [EXIT] repeatedly) to return to the Play screen.

Section 2

Editing

Registering Time (Locator)

Using the locator function, you can register any desired time in a song as a “locator point” so that you can jump to that point later with just the press of a button.

This function is quite useful during editing.

Registering a Locator Point

1. At the Play screen, move to the location where you want to register the locator point.

2. Press [LOCATOR].

When the [LOCATOR] indicator lights up, registration is complete.

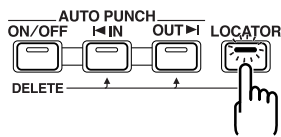

Moving to the Locator Point

1. Press [LOCATOR].

This moves you to the time in the song registered as a locator point.

Deleting a Locator Point

1. Press and hold AUTO PUNCH [ON/OFF], then press [LOCATOR].

The locator point is deleted.

Search for the Music's Start and End (Scrub/Preview)

Scrub function

When editing a sound, some times you need to know exactly where the sound starts, or exactly where the recording with an auto punch in starts.

To enable you to find these points accurately, the BR-900CD is equipped with the Scrub function.

When you use the Scrub function during playback (called "scrubbing"), the portion from your before or after the current location (approximately 45 msec) is played back and repeated.

Preview function

With the Preview function, you can playback the one-second portion of the song before or after your current position.

By using this together with the Scrub function, at the same time slowly moving your current position in the song, it becomes easy to find the exact transition point from one phrase to the next.

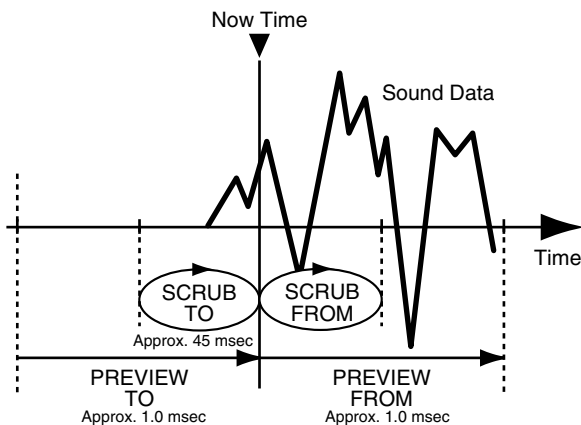

Scrubbing to Find the Music Starting/Ending Point

1. Hold down [STOP] and press [PLAY].

The [PLAY] indicator begins flashing and scrubbing starts.

At this time, the Track 1-7/8 level meters are displayed.

The "↔|" (SCRUB TO) and "|↔" (SCRUB FROM) displayed at the TEMPO position in the screen are the scrub points with respect to the current position.

When the cursor is set under the scrub point, it is possible to change scrub point by TIME/VALUE dial.

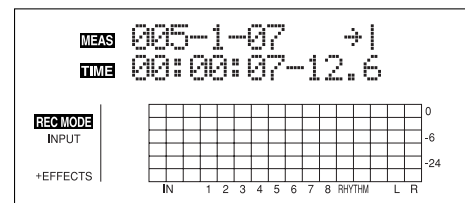
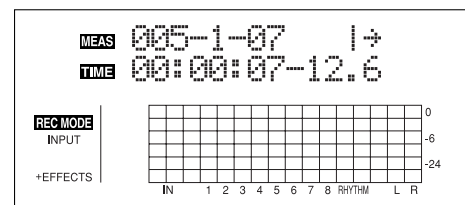

MEMO

You can press [PLAY] to preview the material to or from the currently selected scrub point.

- ↔| PREVIEW FROM
- |↔ PREVIEW TO

HINT

To mute the sound of a particular track, hold down [DELETE/MUTE] and press the relevant REC TRACK button so it starts blinking.

2. Slowly turn the TIME/VALUE dial to move the current position and search for the starting point of the phrase (e.g., where sound is first emitted).
3. After you find the exact point where the music starts, press [STOP] to stop scrubbing.

MEMO

You can now press [LOCATOR] to register a locator point so that you can find the point easily later.

Changing the Scrub Points

Besides switching the scrub point in the Play screen (p. 65), you can also use the following method to switch the scrub point.

1. Press [UTILITY].
2. Press CURSOR [◀] [▶] to move the cursor to "SCR," and press [ENTER].

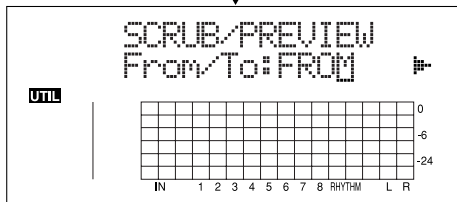
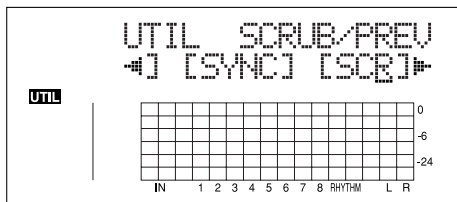

3. Press CURSOR [◀] [▶] to select "FROM/TO," and turn the TIME/VALUE dial to change scrub points.

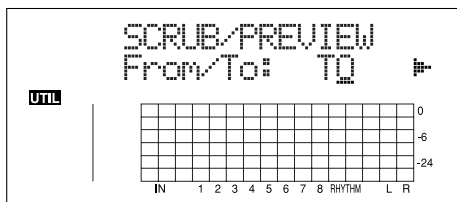

TO: Scrubs to your current position.

FROM: Scrubs from your current position.

4. After completing the setting, press [UTILITY] (or press [EXIT] repeatedly) to return to the Play screen.

* During updating, "Keep power on!" appears in the upper line of the display, while the lower line shows what is being processed.

Enabling Use of the Preview Function with [REW] and [FF]

Besides using [PLAY] for the Preview function (p. 65), you can also set the unit so that [REW] and [FF] can be used with the Preview function.

1. Press [UTILITY].
2. Press CURSOR [◀] [▶] to move the cursor to "SCR," and press [ENTER].

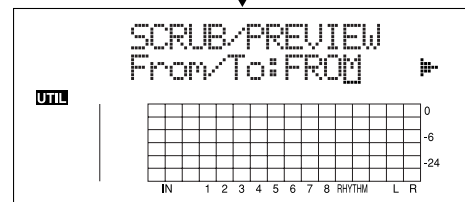
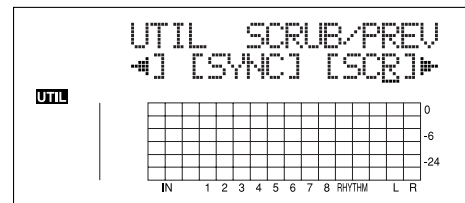

3. Press CURSOR [▶] to select "Preview SW," and turn the TIME/VALUE dial to set "ON."

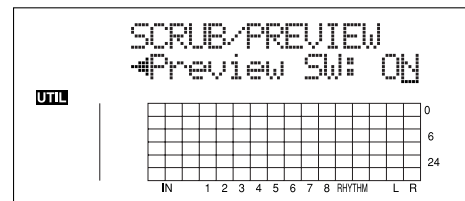

This enables use of the Preview function.

4. Press [UTILITY] (or press [EXIT] repeatedly) to return to the Play screen.

* During updating, "Keep power on!" appears in the upper line of the display, while the lower line shows what is being processed.

MEMO

You can temporarily switch to Preview during scrub with the following operations.

Press [REW]: PREVIEW TO

Press [FF]: PREVIEW FROM

Editing the Performance on a Track (Track Editing)

The BR-900CD allows you to edit your songs by performing editing functions such as copying and moving data recorded on the tracks.

About the Measure/Time Specification screen

Measures and time are specified in the "S" (Start), "E" (End), and "T" (To) screens in Track Edit as shown below.

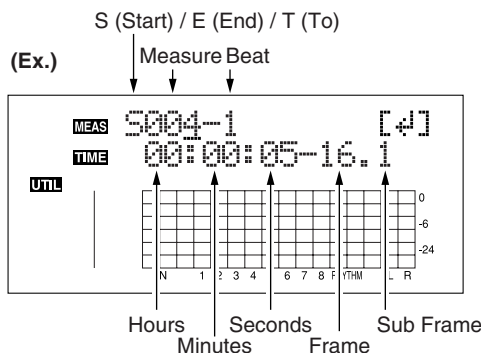

MEMO

Data is saved in its edited form when you return to the Play screen from the Track Edit screen.

- * During automatic updating, "Keep power on!" appears in the upper line of the display, while the lower line shows what is being processed.

MEMO

To copy, move, or erase repeated portions, you first need to set the portion to be repeated, using the procedure described on p. 51.

Copying Data (Track Copy)

Track Copy allows you to copy a specific part of data and then place it in a different location.

You can perform editing operations such as copying the data on a track all at once, or copying the data from a specified part as many times as you wish.

If, for example, you want to use a phrase from a certain track, or have the same phrase repeated again and again, the copy function will help save you time.

- * If data exists at the position being copied to, that data will be overwritten.
- * The portion being copied must be longer than 1.0 seconds long. If the copied portion is 1.0 seconds or less, no sound will be heard even if the copy is carried out.

The three types of Track Copy are given below.

Copying the repeated portion (AB)

Perform the procedure given below to copy the portion from the repeat start (A) to the repeat end (B).

Ex. 1: Copying twice to the same track

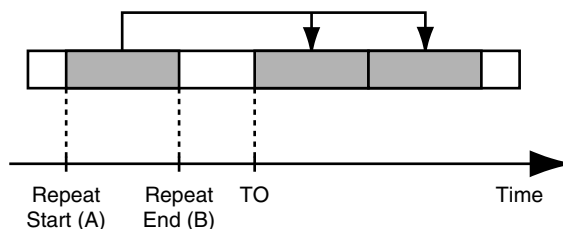

Ex. 2: Copying twice to another track

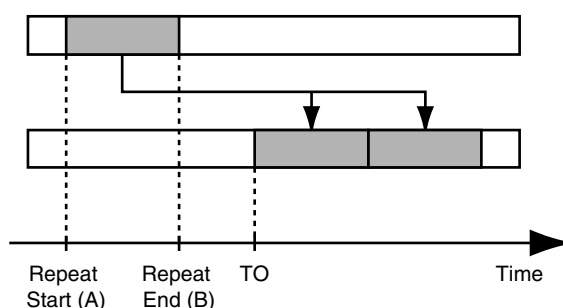

1. Press [UTILITY].
2. Press CURSOR [◀] [▶] to move the cursor to "TRK," and press [ENTER].

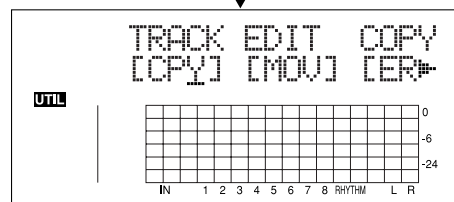
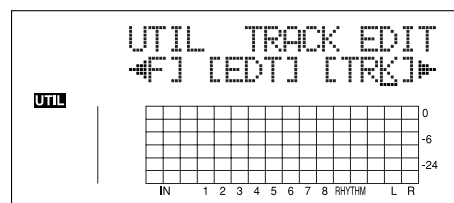

3. Press CURSOR [◀] [▶] to move the cursor to "CPY," and press [ENTER].

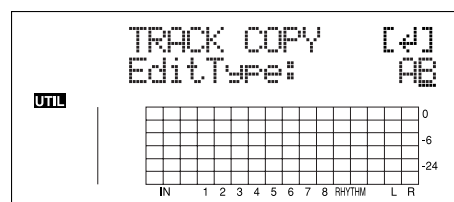

Editing the Performance on a Track (Track Editing)

- Turn the TIME/VALUE dial to select "AB" and press [ENTER].

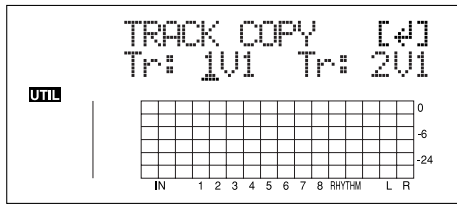

- Use CURSOR [◀] [▶] and the TIME/VALUE dial to select the track/V-Track to copy from, and track/V-Track to copy to.

- Press [ENTER].

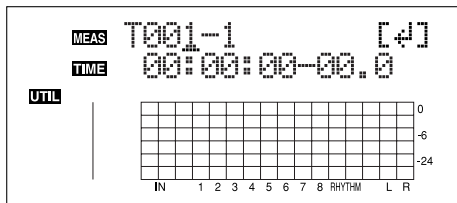

- Use [CURSOR] and turn the TIME/VALUE dial to specify the time of the beginning of the location "T" (To) where you want the copied data to be placed.

- Press [ENTER].

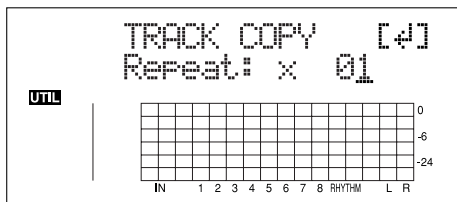

- Turn the TIME/VALUE dial to select the number of copies you want to be placed.

- When you are ready to execute the copy, press [ENTER].

The display will ask "Are you sure?," so that you can confirm the operation.

- Press [ENTER].

The copy is executed.

- Press [UTILITY] (or press [EXIT] repeatedly) to return to the Play screen.

* During updating, "Keep power on!" appears in the upper line of the display, while the lower line shows what is being processed.

Copying by specifying the time (TME/MES)

Perform the procedure given below to copy the portion between specific times.

Ex. 1: Copying twice to the same track

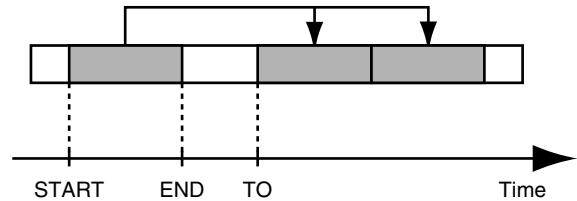

Ex. 2: Copying twice to another track

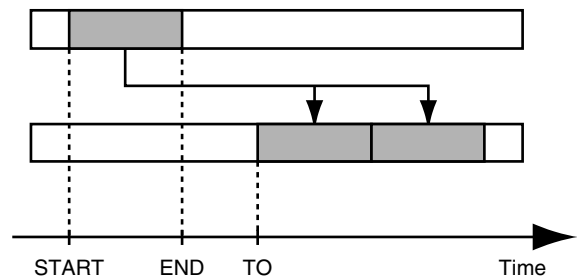

- Press [UTILITY].

- Press CURSOR [◀] [▶] to move the cursor to "TRK," and press [ENTER].

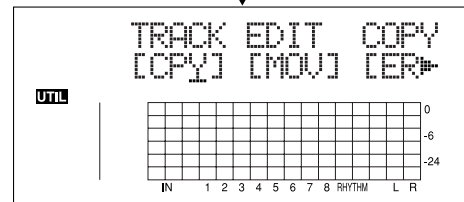
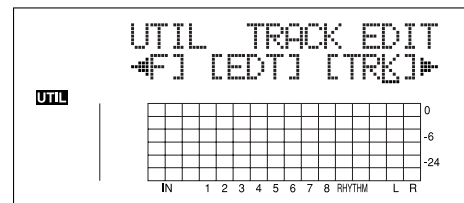

- Press CURSOR [◀] [▶] to move the cursor to "CPY," and press [ENTER].

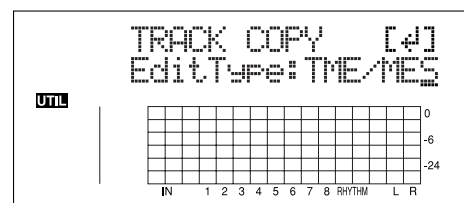

- Turn the TIME/VALUE dial to select "TME/MES" and press [ENTER].

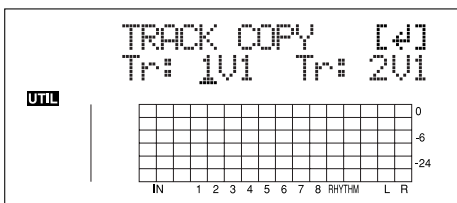

5. Use CURSOR [◀][▶] and the TIME/VALUE dial to select the track/V-Track to copy from, and track/V-Track to copy to.

6. Press [ENTER].

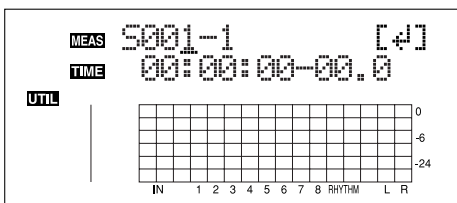

7. Use [CURSOR] and the TIME/VALUE dial to specify the beginning of the portion "S" (Start) of data you want to copy.

8. Press [ENTER].

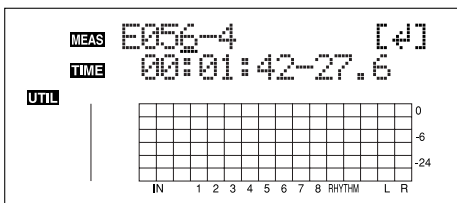

9. Use [CURSOR] and the TIME/VALUE dial to specify the ending of the portion "E" (End) of data you want to copy.

10. Press [ENTER].

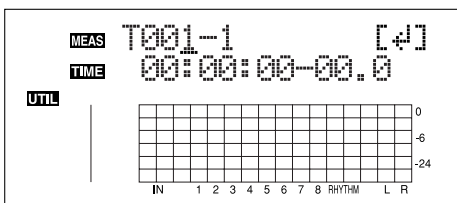

11. Use [CURSOR] and the TIME/VALUE dial to specify the time of the beginning of the location "T" (To) where you want the copied data to be placed.

12. Press [ENTER].

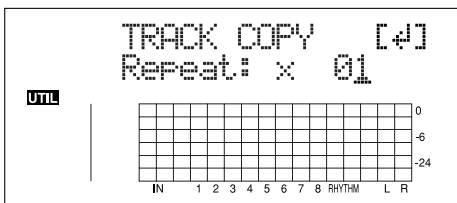

13. Turn the TIME/VALUE dial to select the number of copies you want to be placed.

14. When you are ready to execute the copy, press [ENTER].

The display will ask "Are you sure?," so that you can confirm the operation.

15. Press [ENTER].

The copy is executed.

16. Press [UTILITY] (or press [EXIT] repeatedly) to return to the Play screen.

* During updating, "Keep power on!" appears in the upper line of the display, while the lower line shows what is being processed.

* After specifying the time in the procedure above, a "+" may appear to show that there is a discrepancy between the actual current position and the position displayed. If you specify the locations using measures, specify the locations at each screen using the TIME/VALUE dial to eliminate the discrepancy.

HINT

You can also enter the time using [LOCATOR], [ZERO], [STOP] + [REW], [STOP] + [FF], and AUTO PUNCH [IN/OUT].

Copying a complete track (ALL)

Perform the procedure given below to copy the complete recorded data from one track to another.

1. Press [UTILITY].

2. Press CURSOR [◀][▶] to move the cursor to "TRK," and press [ENTER].

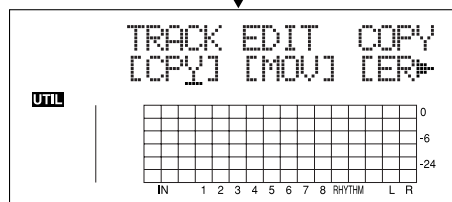
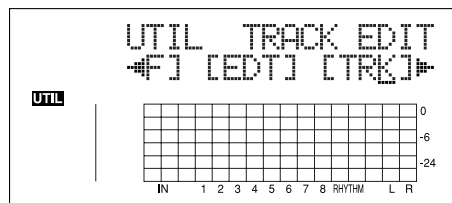

3. Press CURSOR [◀][▶] to move the cursor to "CPY," and press [ENTER].

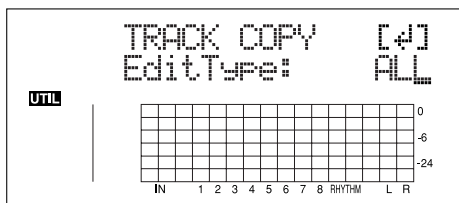

- Turn the TIME/VALUE dial to select "ALL" and press [ENTER].

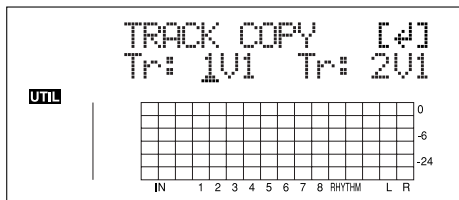

- Use CURSOR [◀] [▶] and the TIME/VALUE dial to select the track/V-Track to copy from, and track/V-Track to copy to.

- When you are ready to execute the copy, press [ENTER].

The display will ask "Are you sure?," so that you can confirm the operation.

- Press [ENTER].

The copy is executed.

- Press [UTILITY] (or press [EXIT] repeatedly) to return to the Play screen.

* During updating, "Keep power on!" appears in the upper line of the display, while the lower line shows what is being processed.

Moving Data (Track Move)

Track Move allows you to move a specific portion of data to a different location.

* After the data is moved, the location it was in will be left empty.

The three types of Track Move are given below.

Moving the repeated portion (AB)

Perform the procedure given below to move the portion from the repeat start (A) to the repeat end (B).

Ex. 1: Moving to the same track

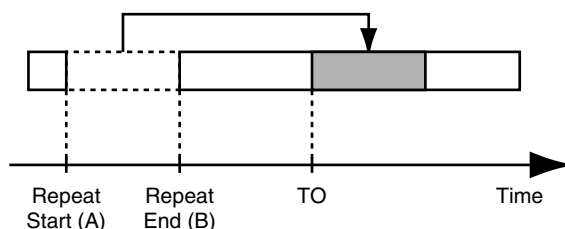

Ex. 2: Moving to another track

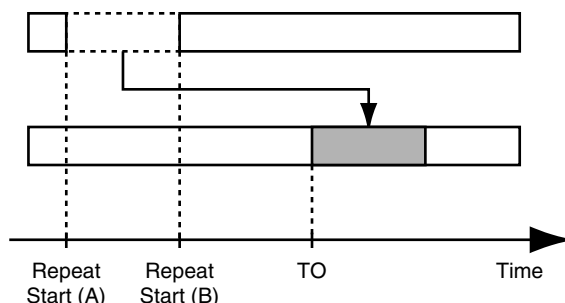

- Press [UTILITY].
- Press CURSOR [◀] [▶] to move the cursor to "TRK," and press [ENTER].

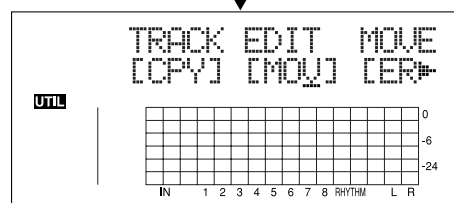
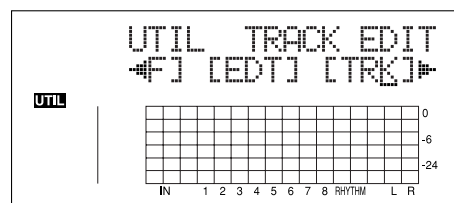

- Press CURSOR [◀][▶] to move the cursor to "MOV," and press [ENTER].

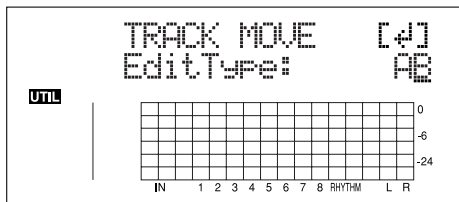

- Turn the TIME/VALUE dial to select "AB" and press [ENTER].

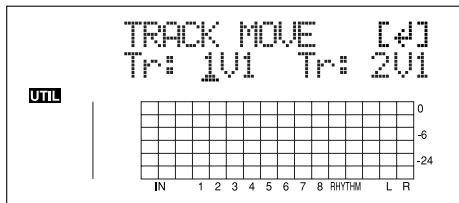

- Use CURSOR [◀][▶] and the TIME/VALUE dial to select the track/V-Track to move from, and track/V-Track to move to.

- Press [ENTER].

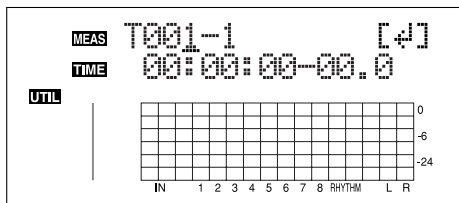

- Use CURSOR [◀][▶] and the TIME/VALUE dial to specify the time of the beginning of the location "T" (To) where you want the data to be moved.
- When you are ready to execute the move, press [ENTER].
The display will ask "Are you sure?," so that you can confirm the operation.
- Press [ENTER].
Move Event is executed.
- Press [UTILITY] (or press [EXIT] repeatedly) to return to the Play screen.

* During updating, "Keep power on!" appears in the upper line of the display, while the lower line shows what is being processed.

Moving by specifying the time (TME/MES)

Perform the procedure given below to move the portion between specific times.

Ex. 1: Moving to the same track

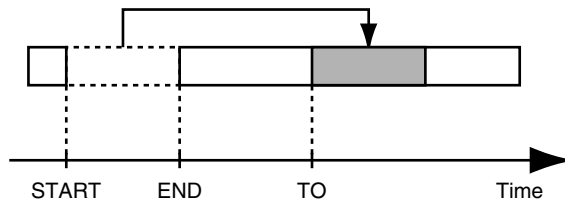

Ex. 2: Moving to another track

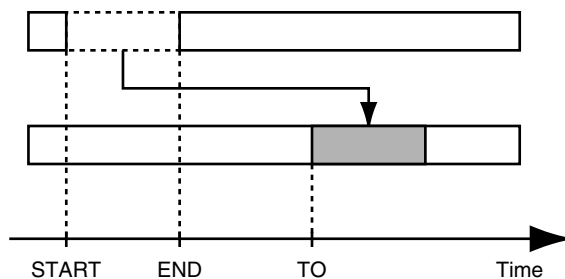

- Press [UTILITY].
- Press CURSOR [◀][▶] to move the cursor to "TRK," and press [ENTER].

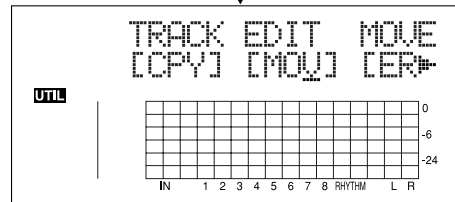
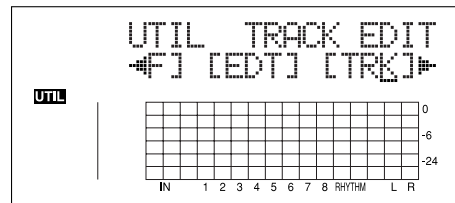

- Press CURSOR [◀][▶] to move the cursor to "MOV," and press [ENTER].

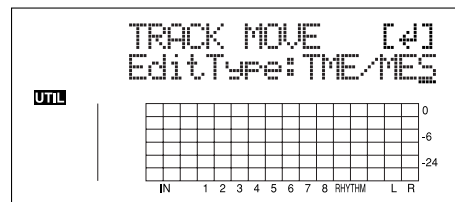

- Turn the TIME/VALUE dial to select "TME/MES" and press [ENTER].

Editing the Performance on a Track (Track Editing)

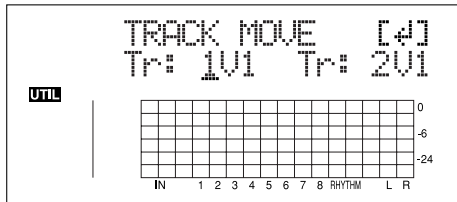

- Use CURSOR [◀] [▶] and the TIME/VALUE dial to select the track/V-Track to move from, and track/V-Track to move to.
- Press [ENTER].

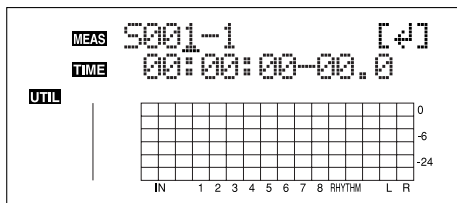

- Use [CURSOR] and the TIME/VALUE dial to specify the beginning of the portion "S" (Start) of data you want to move.
- Press [ENTER].

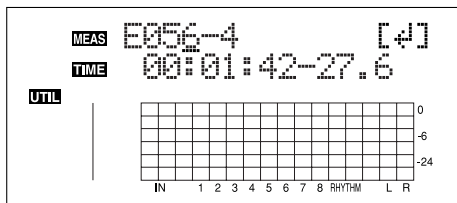

- Use [CURSOR] and the TIME/VALUE dial to specify the ending of the portion "E" (End) of data you want to move.
- Press [ENTER].

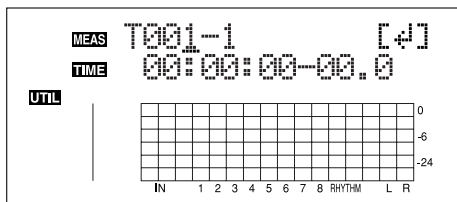

- Use [CURSOR] and the TIME/VALUE dial to specify the time of the beginning of the location "T" (To) where you want the data moved.
- When you are ready to execute the move, press [ENTER].
The display will ask "Are you sure?," so that you can confirm the operation.
- Press [ENTER].
Move Event is executed.
- Press [UTILITY] (or press [EXIT] repeatedly) to return to the Play screen.

* During updating, "Keep power on!" appears in the upper line of the display, while the lower line shows what is being processed.

* After specifying the time in the procedure above, a "+" may appear to show that there is a discrepancy between the actual current position and the position displayed. If you specify the locations using measures, specify the locations at each screen using the TIME/VALUE dial to eliminate the discrepancy.

HINT

You can also enter the time using [LOCATOR], [ZERO], [STOP] + [REW], [STOP] + [FF], and AUTO PUNCH [IN/OUT].

Moving a complete track (ALL)

Perform the procedure given below to move the complete data from one track to another.

- Press [UTILITY].
- Press CURSOR [◀] [▶] to move the cursor to "TRK," and press [ENTER].

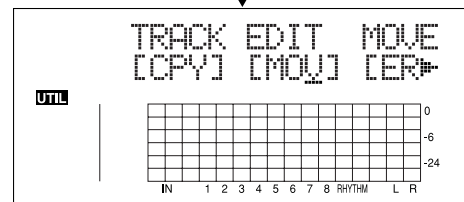
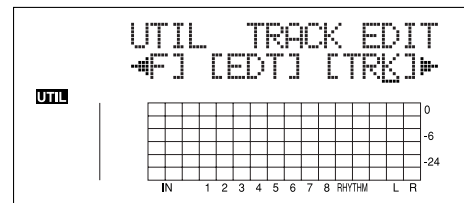

- Press CURSOR [◀] [▶] to move the cursor to "MOV," and press [ENTER].

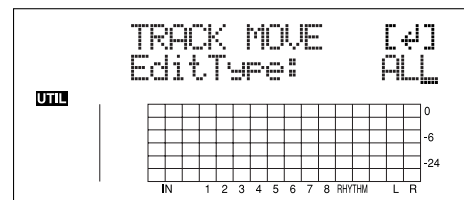

- Turn the TIME/VALUE dial to select "ALL" and press [ENTER].

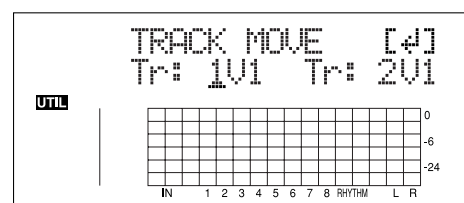

5. Press CURSOR [◀] [▶] and the TIME/VALUE dial to select the track/V-Track to move from, and track/V-Track to move to.
6. Press [ENTER].

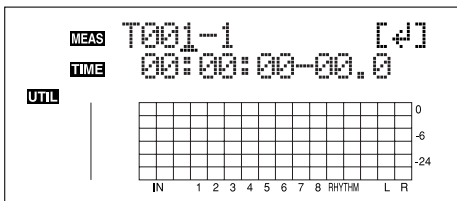

7. Use [CURSOR] and the TIME/VALUE dial to specify the time of the beginning of the location "T" (To) where you want the data to be moved.
8. When you are ready to execute the move, press [ENTER].
The display will ask "Are you sure?" so that you can confirm the operation.
9. Press [ENTER].
Move Event is executed.
10. Press [UTILITY] (or press [EXIT] repeatedly) to return to the Play screen.

* During updating, "Keep power on!" appears in the upper line of the display, while the lower line shows what is being processed.

Erasing Data (Track Erase)

Track Erase allows you to erase a specific part of data. Even if data exists after the specified part, it will not be moved forward to fill the gap left by the erasure. Like a normal tape recorder, erasing can be considered covering unwanted data by recording emptiness.

* Do not leave a portion of less than 1.0 seconds in length after the erased portion. If a portion that short does remain, it will end up being silent.

The three types of Track Erase are given below.

Erasing the repeated portion (AB)

Perform the procedure given below to erase the portion from the repeat start (A) to the repeat end (B).

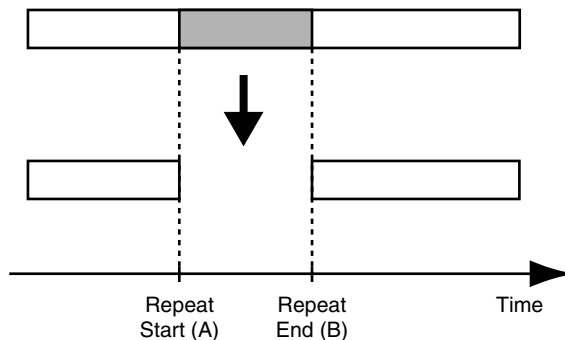

1. Press [UTILITY].
2. Press CURSOR [◀] [▶] to move the cursor to "TRK," and press [ENTER].

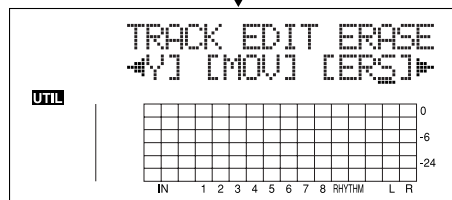
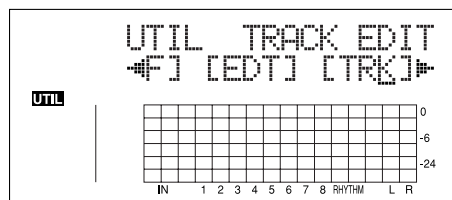

3. Press CURSOR [◀] [▶] to move the cursor to "ERS," and press [ENTER].

Editing the Performance on a Track (Track Editing)

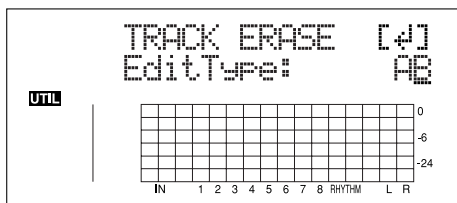

- Turn the TIME/VALUE dial to select "AB" and press [ENTER].

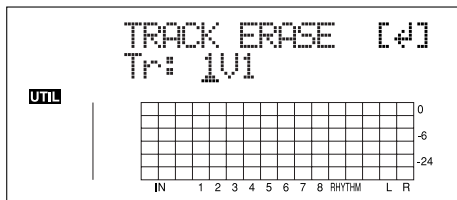

- Use CURSOR [◀] [▶] and the TIME/VALUE dial to select the track/V-Track to erase from.
- When you are ready to execute the erasure, press [ENTER].
The display will ask "Are you sure?," so that you can confirm the operation.
- Press [ENTER].
The erasure is executed.
- Press [UTILITY] (or press [EXIT] repeatedly) to return to the Play screen.

* During updating, "Keep power on!" appears in the upper line of the display, while the lower line shows what is being processed.

Erasing by specifying the time (TME/MES)

Perform the procedure given below to erase the portion between specific times.

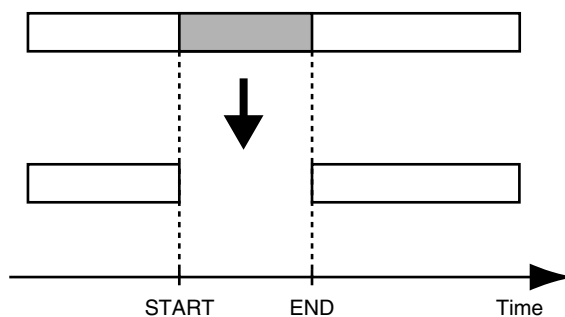

- Press [UTILITY].
- Press CURSOR [◀] [▶] to move the cursor to "TRK," and press [ENTER].

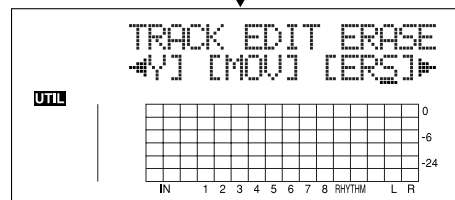
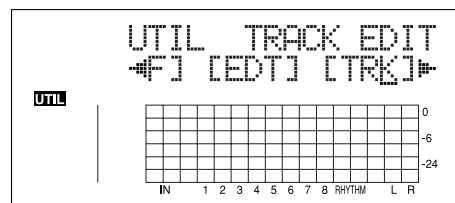

- Press CURSOR [◀] [▶] to move the cursor to "ERS," and press [ENTER].

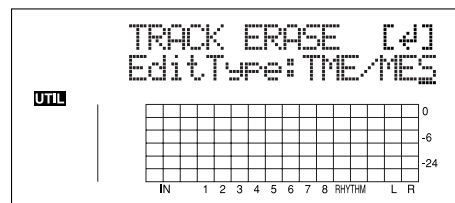

- Turn the TIME/VALUE dial to select "TME/MES" and press [ENTER].

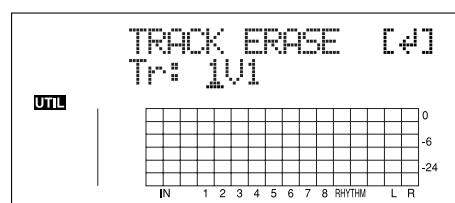

5. Use CURSOR [◀] [▶] and the TIME/VALUE dial to select the track/V-Track to erase from.
6. Press [ENTER].

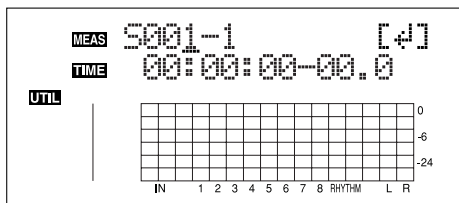

7. Use [CURSOR] and the TIME/VALUE dial to specify the beginning of the portion "S" (Start) of data you want to erase.
8. Press [ENTER].

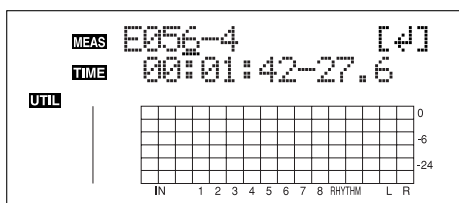

9. Use [CURSOR] and the TIME/VALUE dial to specify the ending of the portion "E" (End) of data you want to erase.
10. When you are ready to execute the erasure, press [ENTER].
The display will ask "Are you sure?," so that you can confirm the operation.
11. Press [ENTER].
The erasure is executed.
12. Press [UTILITY] (or press [EXIT] repeatedly) to return to the Play screen.

- * During updating, "Keep power on!" appears in the upper line of the display, while the lower line shows what is being processed.
- * After specifying the time in the procedure above, a "+" may appear to show that there is a discrepancy between the actual current position and the position displayed. If you specify the locations using measures, specify the locations at each screen using the TIME/VALUE dial to eliminate the discrepancy.

HINT

You can also enter the time using [LOCATOR], [ZERO], [STOP] + [REW], [STOP] + [FF], and AUTO PUNCH [IN/OUT].

Erasing a complete track (ALL)

1. Press [UTILITY].
2. Press CURSOR [◀] [▶] to move the cursor to "TRK," and press [ENTER].

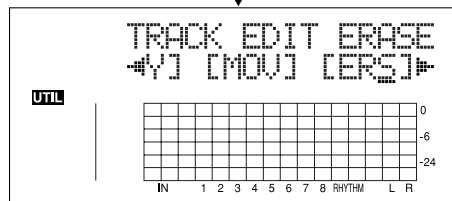
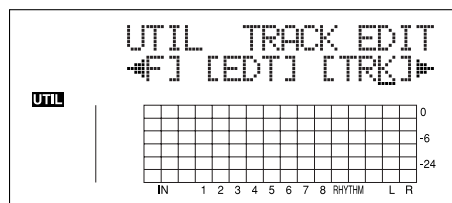

3. Press CURSOR [◀] [▶] to move the cursor to "ERS," and press [ENTER].

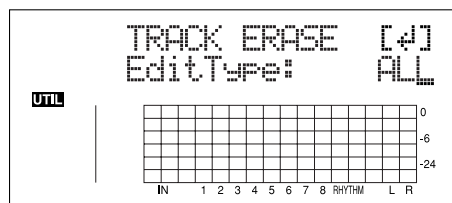

4. Turn the TIME/VALUE dial to select "ALL" and press [ENTER].

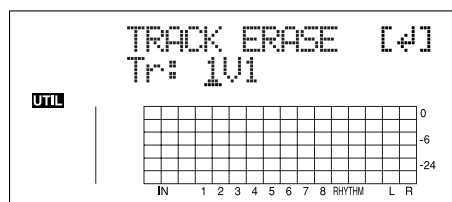

5. Use CURSOR [◀] [▶] and the TIME/VALUE dial to select the track/V-Track to erase.
6. When you are ready to execute the erasure, press [ENTER].
The display will ask "Are you sure?," so that you can confirm the operation.
7. Press [ENTER].
The erasure is executed.
8. Press [UTILITY] (or press [EXIT] repeatedly) to return to the Play screen.

- * During updating, "Keep power on!" appears in the upper line of the display, while the lower line shows what is being processed.

Exchanging Data (Track Exchange)

Perform the procedure given below to exchange the data between two tracks.

Example: exchanging all the data on track 1 with all the data on track 2

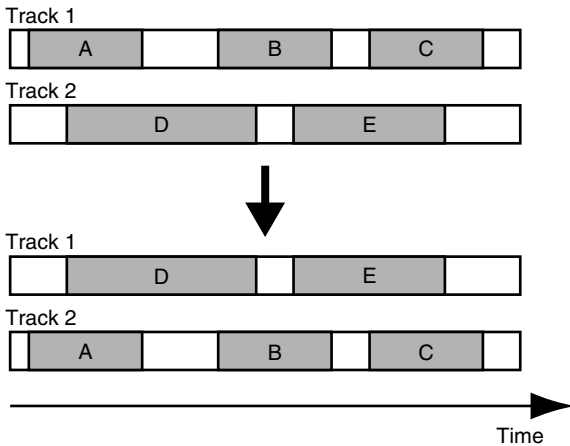

1. Press [UTILITY].
2. Press CURSOR [◀] [▶] to move the cursor to "TRK," and press [ENTER].

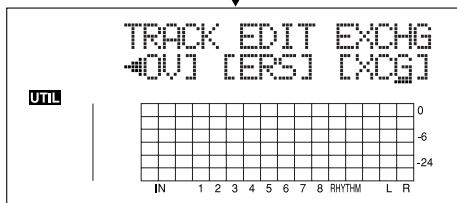
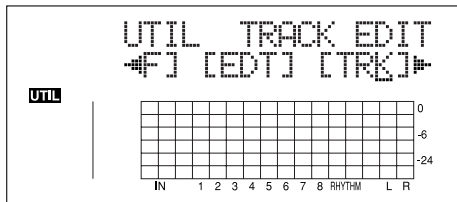

3. Press CURSOR [◀] [▶] to move the cursor to "XCG," and press [ENTER].

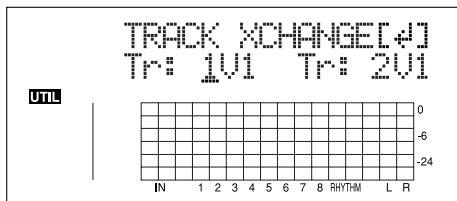

4. Use CURSOR [◀] [▶] and the TIME/VALUE dial to select the two tracks/V-Tracks to exchange data.

5. When you are ready to execute the exchange, press [ENTER].

The display will ask "Are you sure?," so that you can confirm the operation.

6. Press [ENTER].

The exchange is executed.

7. Press [UTILITY] (or press [EXIT] repeatedly) to return to the Play screen.

* During updating, "Keep power on!" appears in the upper line of the display, while the lower line shows what is being processed.

Organizing the Songs You've Recorded

Copying a Song (Song Copy)

Follow the procedure below to copy the currently selected song.

1. Press [UTILITY].
2. Press CURSOR [◀][▶] to move the cursor to "EDT," and press [ENTER].

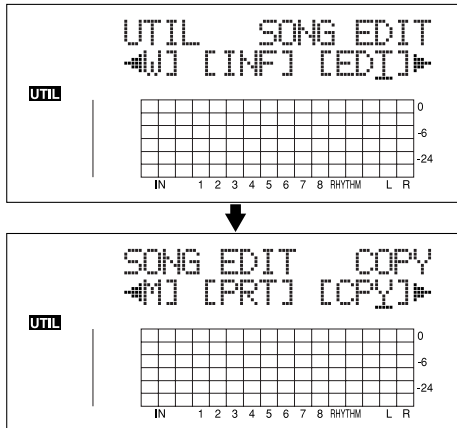

3. Press CURSOR [◀][▶] to move the cursor to "CPY," and press [ENTER].

The Copy Song screen appears.

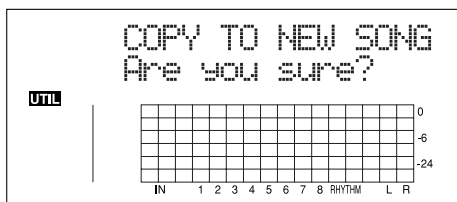

If "Card Full!" appears

If this message appears before the copy, it means that there is insufficient space on the memory card to complete the copy. Delete any unnecessary recording from the memory card.

4. Press [ENTER].
The copy is executed. When the copy has been completed, "Completed!" appears in the display, and you are returned to the Play screen.

Erasing Songs (Song Erase)

Follow the procedure below to erase a song from the memory card.

1. Press [UTILITY].
2. Press CURSOR [◀][▶] to move the cursor to "EDT," and press [ENTER].

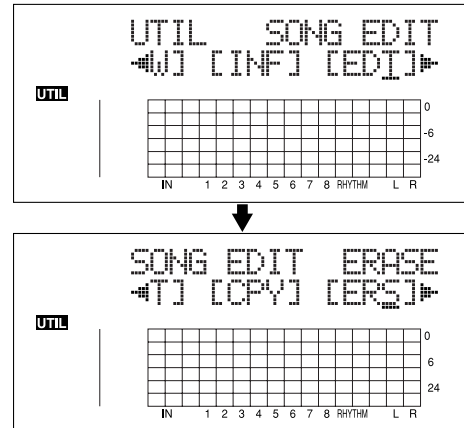

3. Press CURSOR [◀][▶] to move the cursor to "ERS," and press [ENTER].

The Erase Song screen appears.

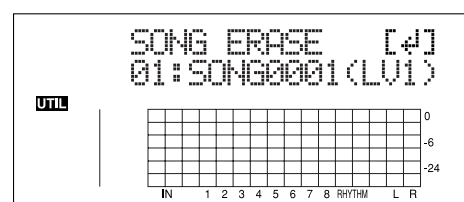

4. Turn the TIME/VALUE dial and select the song to be erased.
5. After selecting the song to erase, press [ENTER].
"Are you sure?" appears.
6. To continue with the erasure, press [ENTER] (YES). To cancel the operation press the [EXIT] (NO) (or [UTILITY]).
7. Press [UTILITY] (or press [EXIT] repeatedly) repeatedly to return to the Play screen.

* If you erase a song currently being used, the song on the memory card with the lowest number is selected. If there are no other songs on the card, a new song is created.

Saving Memory on the Memory Card (Song Optimize)

When you perform overdubbing or punch-in/out, the data that you rewrite (replace) actually remains on the memory card. In some cases, this unwanted data may occupy a significant amount of space on the memory card. This will cause the time available for recording to be less than it should be.

By performing a "Song Optimize," you can have the BR-900CD erase any unnecessary data on the memory card and increase the unused space.

1. Press [UTILITY].
2. Press CURSOR [◀][▶] to move the cursor to "EDT," and press [ENTER].

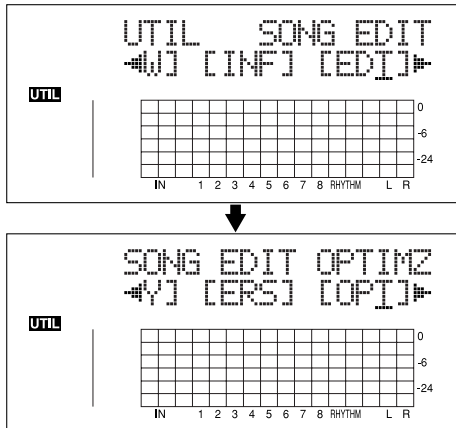

3. Press CURSOR [◀][▶] to move the cursor to "OPT," and press [ENTER].
"Are you sure?" appears in the display.

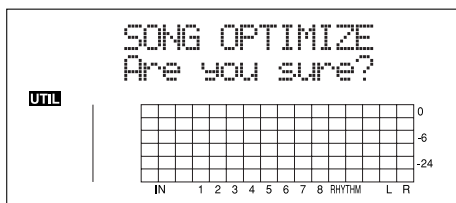

4. To continue with the optimization, press [ENTER] (YES).
The Song Optimize function is carried out. When completed, "Completed!" appears in the display, and you are returned to the Play screen.
To cancel the operation press the [EXIT] (NO) (or [UTILITY]).

- * Depending on the situation, an appreciable length of time may be required for Optimize to be completed. This is not a malfunction. Do not turn off the power until Optimize has completed.
- * After you execute Optimize, it is not possible to undo/redo to revert to the state before executing Optimize.

Naming Songs (Song Name)

When a new song is created, it is automatically given a name such as "SONG 0001." With your BR-900CD, you can use "Song Name" to give each song a name, which helps you manage and organize your songs.

1. Press [UTILITY].
2. Press CURSOR [◀][▶] to move the cursor to "EDT," and press [ENTER].

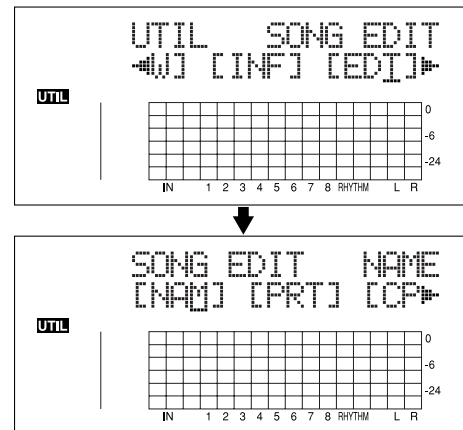

3. Press CURSOR [◀][▶] to move the cursor to "NAM," and press [ENTER].
The name of the song (Song Name) appears in the display.

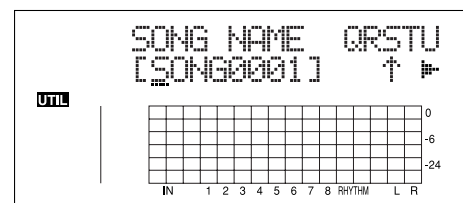

4. Press CURSOR [◀][▶] to move the cursor to the character you want to change.
5. Rotate TIME/VALUE dial to select the character.
* You can switch between upper case and lower case characters by pressing [ENTER].
6. After the name is properly entered, press [UTILITY] (or press [EXIT] repeatedly) to return to the Play screen.

Protecting a Song (Song Protect)

You can imagine situations where, after taking care to create a song, you accidentally overwrite it with a recording, deleting the performance itself.

To prevent such accidents, you can protect song data so that it cannot be rewritten accidentally (Song Protect).

* The following operations are not available when a song is protected.

- Editing a song name
- Erasing a song
- Song Optimize
- Editing a digital copy protect
- Initializing the Rhythm (arrangements/patterns/drum kits)
- Initializing effects (song patches)
- Initialize All
- Arrangement/Pattern Edit
- Importing SMFs
- Writing effects to song patches

1. Press [UTILITY].
2. Press CURSOR [◀] [▶] to move the cursor to "EDT," and press [ENTER].

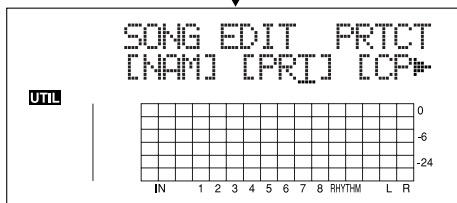
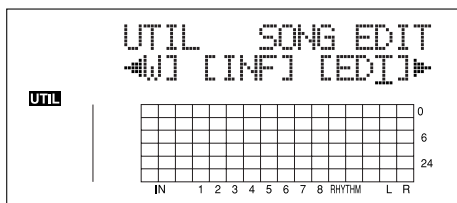

3. Press CURSOR [◀] [▶] to move the cursor to "PRT," and press [ENTER].

The Song Protect screen appears.

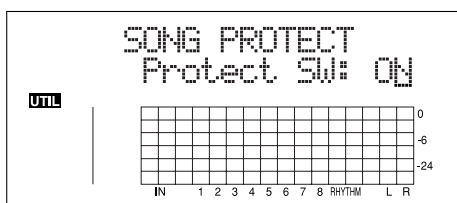

4. Rotate TIME/VALUE dial to select the "ON."
5. Press [UTILITY] (or press [EXIT] repeatedly) to return to the Play screen.

When a song is protected, the display will show the song protect symbol.

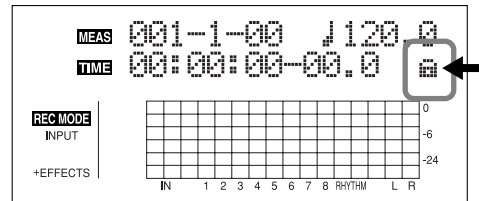

Saving the Current Settings to the Song (Song Save)

The BR-900CD can save the following contents as song data.

- Recorded data
- Mixer settings (Pan, Track EQ, etc.)
- Insert Effect song patches
- Mastering Tool Kit song patches
- Pitch Correction song patches
- Rhythm Arrangements / Rhythm Patterns
- Loop Effects
- Tuner
- Utility (excluding LCD contrast)

These recorded data or mixer settings are not saved immediately after recording, but are saved when songs are saved, and when the screens are switched.

Ordinarily, if a situation calls for it, a message appears in the display prompting you to confirm that you want to save the data, so you need not pay particular attention to this, but if you want to save the settings to the song in its current state, use the following procedure.

1. Hold down [STOP] and press [REC].

Creating a Master Tape / Disc

This process involves recording the finished song to your recorder (cassette tape recorder, CD recorder, etc.) and making a master tape or a master disc.

Recording to a Cassette Tape Recorder (Analog Connection)

1. Connect the BR-900CD's LINE OUT jacks to the cassette tape recorder's input jacks.

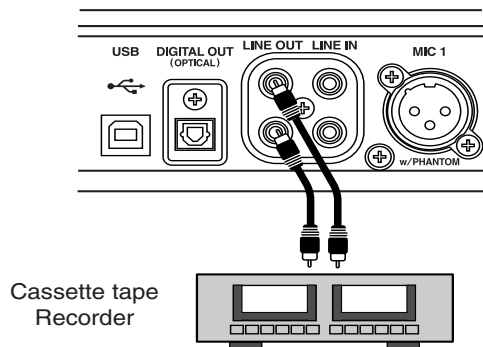

2. Put the cassette tape recorder in record mode.
3. Press [PLAY] on the BR-900CD and start the playback of the recorded data.

Recording to a Digital Recorder (Digital Connection)

1. Connect the BR-900CD's DIGITAL OUT connector to the digital recorder's input connector.

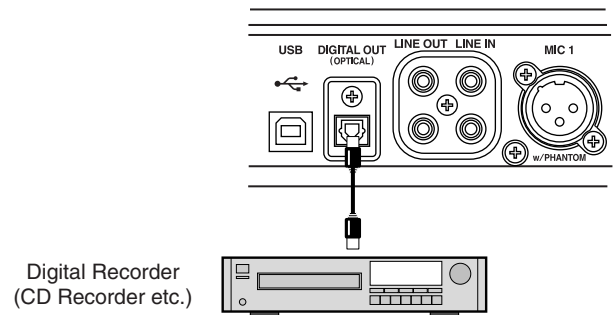

2. Set the digital recorder so it is ready to record digital signals.
3. Put the digital recorder in record mode.
4. Press [PLAY] on the BR-900CD and start the playback of the recorded data.

Disabling digital copying (Digital Copy Protect)

When recording from the BR-900CD to a digital recorder, you can prevent further digital copying of the master tape or disc to any other digital recorders.

1. Press [UTILITY].
2. Press CURSOR [◀] [▶] to move the cursor to "EDT," and press [ENTER].

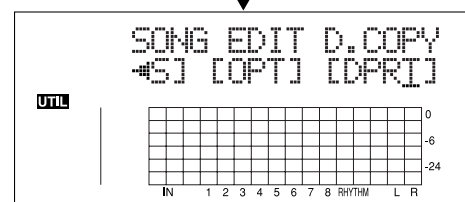
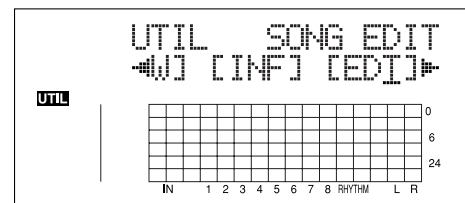

3. Press CURSOR [\leftarrow] [\rightarrow] to move the cursor to "DPRT," and press [ENTER].

The Digital Copy Protect screen appears.

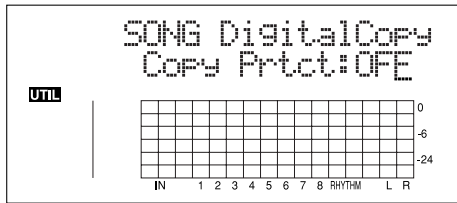

4. Rotate TIME/VALUE dial to select the "ON."

ON: Digital copying will be prohibited.

OFF: Digital copying is enabled.

5. Press [UTILITY] (or press [EXIT] repeatedly) to return to the Play screen.

- * During updating, "Keep power on!" appears in the upper line of the display, while the lower line shows what is being processed.
- * Some DAT recorders do not support SCMS, or do not allow digital connections to a CD player. If you are using this type of DAT recorder, it will not be possible to record the digital output of the BR-900CD on a DAT recorder if "Copy Prtct" is turned "ON." In this case, you will need to turn off the "Copy Prtct" setting.

What is SCMS?

SCMS stands for Serial Copy Management System.

This is a function of consumer digital audio devices such as DAT recorders CD recorders that protects the copyright of the producer by prohibiting second-generation and subsequent copies from being made digitally.

If digital connections are made to a digital recorder that has this function, SCMS flags will be recorded along with the digital audio signals.

Digital audio data that contains this data cannot be recorded again via a digital connection.

MEMO

Section 3

Using Effects

Using the Insert Effects

The BR-900CD comes with five effects processors: an insert effects, loop effects, Track EQ, Pitch Correction, and Mastering Tool Kit.

An insert effects, loop effects, and Track EQ can be used simultaneously, and you can make settings for each effect as desired.

Here is an explanation of how to change the various parameters for the insert effects and how to then save those changes.



“Insert Effect Parameter Functions” (p. 88)

“Loop Effect Parameter Functions” (p. 111)

“Track EQ Parameter Functions” (p. 112)

MEMO

Insert effects are applied during recording, in addition they are applied during the mixing of the various tracks as well. For more details, refer to “Changing How the Insert Effects are Used According to the Mode” (p. 87).

Effect Patches and Banks

The effects used by insert effects and the parameters of each effect are changed by calling up “effect patches.”

Your BR-900CD comes equipped with a number of preset effect patches for use with vocals and instruments. These are grouped according to different input sources and each group is called a “bank.”

	INPUT SELECT			
	GUITAR/BASS	MIC	LINE	SIMUL
	Guitar Bank GTR	Mic Bank MIC	Line Bank LIN	Simul Bank SML
Preset Patch →	P01 ⋮ P99	P01 ⋮ P40	P01 ⋮ P50	P01 ⋮ P50
User Patch →	U01 ⋮ U99	U01 ⋮ U40	U01 ⋮ U50	U01 ⋮ U50
Song Patch →	S01 ⋮ S99	S01 ⋮ S40	S01 ⋮ S50	S01 ⋮ S50

Your BR-900CD allows you to automatically change banks by pressing an INPUT SELECT button. For example, pressing the [GUITAR/BASS/MIC2] INPUT SELECT button changes you to a guitar bank patch, and pressing [LINE] changes you to a line bank patch.

Also, within each bank, effect patches are further grouped as shown below.

Preset patches (P)

The preset patches contain preset data. Their settings can be changed, but you cannot create a new preset patch.

User patches (U)

User patches can be rewritten, and are stored in internal memory. If you have created a patch that you would like to use for other songs as well, it is convenient to store it as a user patch.

Song patches (S)

Like user patches, song patches can be written; however, the data for song patches are stored along with the song data to the memory card. This is convenient when you have created a patch for a specific recorded performance, and would like to store that patch together with the song.

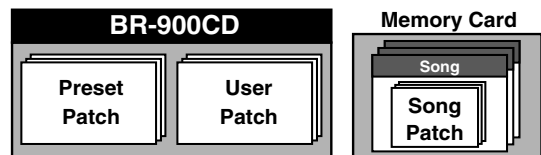

* Song patches (S) cannot be selected unless a memory card is inserted.

MEMO

Your BR-900CD is shipped with the user patches (U) and song patches (S) containing the same patches as the preset patches (P).

MEMO

When you create a new song, copies of the patches in the song patches (S) are made in the preset patches (P) for each bank.

Editing Insert Effect Settings

If you wish to create a new effect sound, you should first select an existing patch that is closest to the sound you want, and then edit its settings. If you wish to save the effect settings that you edited, save them as a user patch or song patch.

1. Press [EFFECTS].

The Effect screen appears.

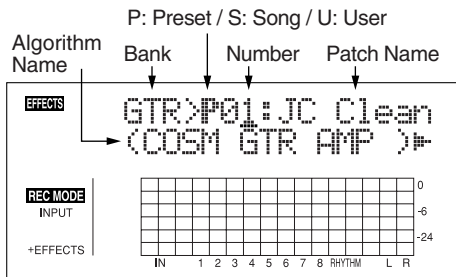

2. Select an effect patch.

Use CURSOR [◀][▶] and the TIME/VALUE dial to select the bank, Preset/Song/User, and patch number.

3. Press CURSOR [▶] to move the cursor to "EDIT," and press [ENTER].

The Edit Effect screen appears and the algorithm (the connection sequence for the effects being used) is displayed.

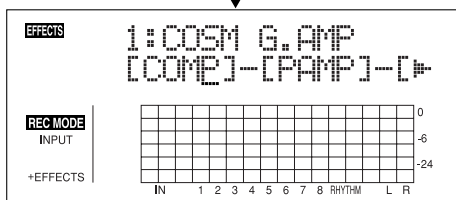
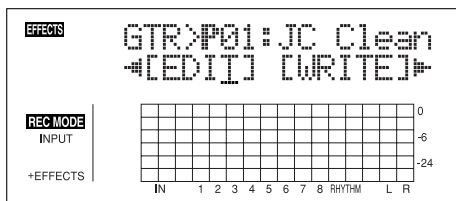

■ When effect patches in the SIMUL bank are selected, "GTR" and "MIC" appear.

Move the cursor to "GTR" to modify a guitar-use effect, or to "MIC" to modify an effect for use with a mic, then press [ENTER].

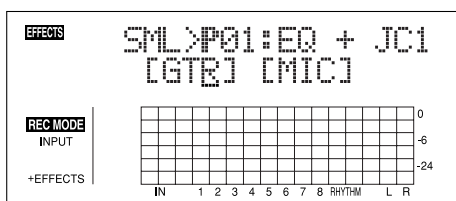

HINT

By pressing [ENTER] while the cursor is at a Bank-Number, you can display the Edit Effect screen directly.

4. Press CURSOR [◀][▶] to move the cursor to each effect and turn the TIME/VALUE dial to turn each effect on or off.

Blocks that are turned on are shown in uppercase letters, while blocks that are turned off are shown in lowercase letters.

Turn on the effects that you want to use.

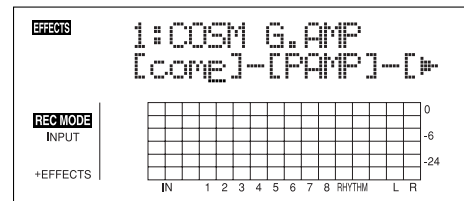

5. Press CURSOR [◀][▶] to move the cursor to the effect with the parameter that you want to change and press [ENTER].

The Parameter Setting screen for each effect appears.

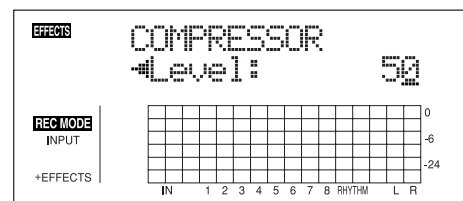

6. Use CURSOR [◀][▶] to select a parameter, and turn the TIME/VALUE dial to edit the value.

7. If you would like to edit another effect, press [EXIT] to return to the previous screen, and repeat steps 5–6.

8. If you wish to save the current effect settings, perform the procedure described in "Saving insert effect settings," next.

NOTE

Edited effect settings are temporary. If you exit the Edit Effect screen without saving the effect patch you changed, "TMP" appears next to the indication of the bank.

Be aware that if you select a new effect patch while "TMP" is displayed, the altered effect patch is returned to its original settings and the changes are lost.

Saving Insert Effects Settings (Write)

Follow the procedure below to enter a name (patch name) for an effect that you've modified, and save it as a new effect patch.

- * You cannot save an effect patch during the recording or playback of a song.
- * If you do not need to change patch name, go to step 4.

1. At the Effect screen, press CURSOR [\triangleright] to move the cursor to "NAME," and press [ENTER].

The Patch Name Setting screen appears.

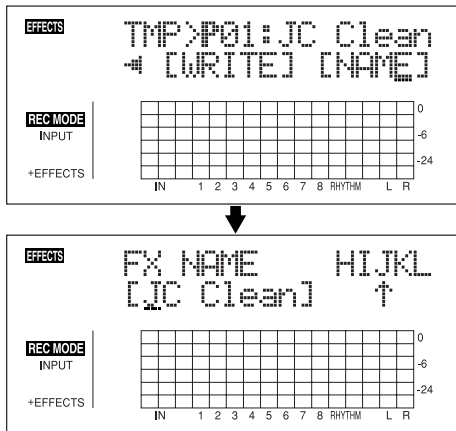

2. Use [CURSOR] and the TIME/VALUE dial to enter the patch name.

- * Press [ENTER] to switch between uppercase and lowercase.

3. After you have completed entering the effect settings and patch name as desired, press [EXIT] to return to the Effect screen.

4. Press CURSOR [\triangleleft] [\triangleright] to move the cursor to "WRITE," and press [ENTER].

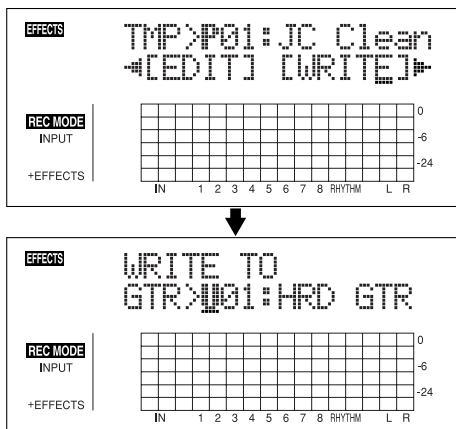

5. Turn the TIME/VALUE dial to select the number to which to write the new effect patch.
 6. After you've selected the destination, press [ENTER]. After the save has been completed, you are returned to the Effect screen.
- * During updating, "Keep power on!" appears in the upper line of the display, while the lower line shows what is being processed.

Changing How the Insert Effects are Used According to the Mode

By default, the insert effect is inserted immediately after the input source. The reason for this is to allow for the effects-processed (wet) sound to be recorded and monitored. However, sometimes you want to change the connection order.

On the BR-900CD, you can accommodate a wide variety of situations by changing the point to which the insert effects are connected.

Follow the procedure below to change where insert effects are connected.

1. Press [EFFECTS].
2. Press CURSOR [◀] [▶] to move the cursor to "LOCAT," and press [ENTER].

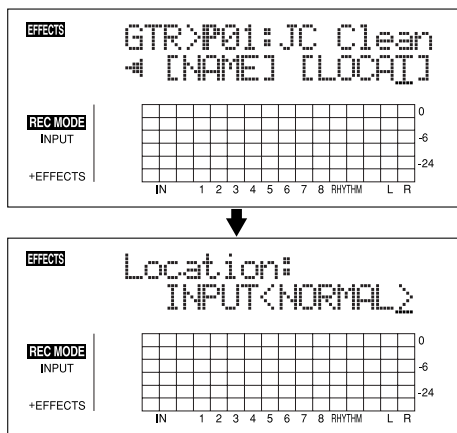

3. Turn the TIME/VALUE dial to switch the point to which the insert effects are connected.

INPUT<NORMAL>:

The sound is monitored and recorded after it passes through the insert effect. Normally you will use the BR-900CD with this setting.

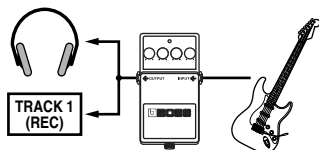

INPUT<REC DRY>:

The sound is monitored through the insert effect but is recorded without the effect (dry).

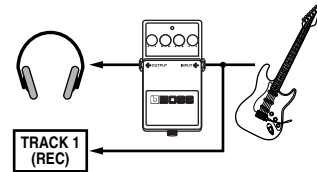

TRACK 1-8, 1&2, 3&4, 5&6, 7&8:

The insert effect can be applied to the playback of a track (or pair of tracks). Use this when you wish to try out effects after recording the dry sound, or when you wish to apply effects only to a specific track.

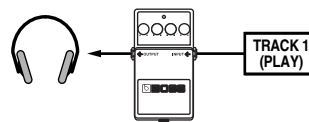

RHYTHM:

The insert effect can be applied to the playback of a Rhythm.

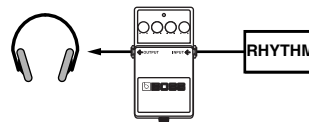

MASTER:

Use this when you wish to apply effects to the entire song, such as when adjusting the tone or applying a special effect during mixdown.

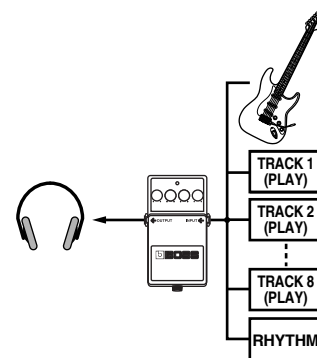

4. Press [EXIT] to return to the Play screen.

* During updating, "Keep power on!" appears in the upper line of the display, while the lower line shows what is being processed.

Insert Effect Parameter Functions

Algorithm List

The algorithms (the available effects and their connection order) that can be used as an insert effect are shown below.

The algorithms that can be selected will differ for each bank. To select the algorithm that you wish to use, first select the effect bank that includes that algorithm, and then refer to the "Effect Patch List" (p. 202) and select a patch that uses the desired algorithm.

The line or lines connecting the algorithm indicate whether the effect features mono output (single line) or stereo output (two lines).

(Example)

Output: Mono Output: Stereo
-[COMP]-[PAMP]- -[MOD]=[DLY]=

BANK: GUITAR

1. COSM GTR AMP

This is a multi-effect designed for electric guitar. This provides an amp sound using a preamp and speaker simulator.

* In case of "Phaser," output will become monaural.

-[COMP]-[PAMP]-[SP]-[EQ/WAH] }
└-[NS]-[FV]-[MOD]=[DLY]=

Compressor

Preamp

Speaker Simulator

4Band Equalizer/Wah

- 4Band Equalizer

- Wah

Noise Suppressor

Foot Volume

Modulation

- Flanger

- Chorus

- Phaser

- Pitch Shifter

- Doubling

- Tremolo/Pan

- Slow Attack

Delay

2. ACOUSTIC SIM

This is a multi-effect designed for electric guitar. It allows you to use an electric guitar to produce sounds similar to those of an acoustic guitar.

-[ASIM]-[COMP]-[EQ]-[NS] }
└-[FV]-[MOD]=[DLY]=

Acoustic Guitar Simulator

Compressor

4Band Equalizer

Noise Suppressor

Foot Volume

Modulation

- Flanger

- Chorus

- Phaser

- Pitch Shifter

- Doubling

- Tremolo/Pan

Delay

3. BASS SIM

Simulates the sound of a bass guitar. Obtain the sound of a bass guitar while playing an electric guitar.

* You should avoid playing chords when using the Bass Simulator.

-[BSIM]-[COMP/DEF]-[NS]-[FV]-[MOD]=

Bass Simulator

Compressor/Defretter

- Compressor
- Defretter

Noise Suppressor

Foot Volume

Modulation

- Flanger
- Chorus
- Phaser
- Pitch Shifter
- Doubling
- Tremolo/Pan

4. COSM COMP GTR

This is a multi-effect designed for electric guitar. In addition to a COSM compressor/limiter, it uses a preamp and speaker simulator for a characteristic amp sound.

-[COMP]-[PAMP]-[SP]-[EQ/WAH]
-[NS]-[FV]-[DLY]=

COSM Comp/Limiter

Preamp

Speaker Simulator

4Band Equalizer/Wah

- 4Band Equalizer
- Wah

Noise Suppressor

Foot Volume

Delay

5. ACOUSTIC GTR

This is a multi-effect designed for acoustic guitar. Even when an electric-acoustic is connected at line level, this provides a warm sound similar to what is obtained through a microphone.

-[ACP]=[COMP]=[EQ]=[NS]=[DLY]=

Acoustic Processor

Compressor

4Band Equalizer

Noise Suppressor

Delay

6. BASS MULTI

This is a multi-effect designed for bass guitar. Appropriate for creating standard bass sound.

-[COMP/DEF]-[OCT]-[ENH]-[EQ/WAH]
-[NS]-[FV]-[MOD]=[DLY]=

Compressor/Defretter

- Compressor
- Defretter

Octave

Enhancer

4Band Equalizer/Wah

- 4Band Equalizer
- Wah

Noise Suppressor

Foot Volume

Modulation

- Flanger
- Chorus
- Phaser
- Pitch Shifter
- Doubling
- Tremolo/Pan

Delay

7. COSM BASS AMP

This is a multi-effect designed for bass guitar. This features an amp sound that uses a preamp and speaker simulator.

-[COMP]-[PAMP]-[SP]-[EQ/WAH]
 └──┬──┘
 [NS]-[FV]-[MOD]=[DLY]=

- Compressor
- Preamp
- Speaker Simulator
- 4Band Equalizer/Wah
 - 4Band Equalizer
 - Wah
- Noise Suppressor
- Foot Volume
- Modulation
 - Flanger
 - Chorus
 - Phaser
 - Pitch Shifter
 - Doubling
 - Tremolo/Pan

Delay

8. COSM COMP BSS

This is a multi-effect designed for bass guitar. In addition to a COSM compressor/limiter, it uses a preamp and speaker simulator for a characteristic amp sound.

-[COMP/LIM]-[PAMP]-[SP]
 └──┬──┘
 [EQ/WAH]-[NS]-[FV]-[DLY]=

- COSM Comp/Limiter
- Preamp
- Speaker Simulator
- 4Band Equalizer/Wah
 - 4Band Equalizer
 - Wah
- Noise Suppressor
- Foot Volume
- Delay

BANK: MIC

9. VOCAL MULTI

This is a multi-effect designed for vocals. It provides the basic effects needed for vocals.

-[COMP]-[DES]-[ENH]-[EQ]
 └──┬──┘
 [NS]-[FV]-[MOD]=[DLY]=

- Compressor
- De-esser
- Enhancer
- 4Band Equalizer
- Noise Suppressor
- Foot Volume
- Modulation
 - Flanger
 - Chorus
 - Phaser
 - Pitch Shifter
 - Doubling
 - Tremolo/Pan

Delay

10. VOICE TRANS

This is a multi-effect designed for vocals. This allows you to produce a unique effect using a voice transformer.

-[VT]-[NS]-[FV]-[MOD]=[DLY]=

- Voice Transformer
- Noise Suppressor
- Foot Volume
- Modulation
 - Flanger
 - Chorus
 - Phaser
 - Pitch Shifter
 - Doubling
 - Tremolo/Pan
- Delay

11. COSM COMP VCL

This is a multi-effect designed for vocals.

The COSM compressor/limiter is perfect for creating a basic sound.

-[COMP/LIM]-[DES]-[ENH]
 [EQ]-[NS]-[FV]-[DLY]=

COSM Comp/Limiter

De-esser

Enhancer

4Band Equalizer

Noise Suppressor

Foot Volume

Delay

BANK: LINE

12. STEREO MULTI

This algorithm connects seven types of effect, all in full stereo.

= [COMP] = [RNG] = [EQ/WAH]
 [NS] = [FV] = [MOD] = [DLY] =

Compressor

Ring Modulator

4Band Equalizer/Wah

- 4Band Equalizer

- Wah

Noise Suppressor

Foot Volume

Modulation

- Flanger

- Chorus

- Phaser

- Pitch Shifter

- Doubling

- Tremolo/Pan

Delay

13. LO-FI BOX

This allows you to simulate sounds that appear to be playing on an AM radio, the sounds of old records played on an old-fashioned gramophone, and even extreme deformations of the sound produced by a Lo-Fi Digital.

= [LOFI] = [NS] =

Lo-Fi Box

Noise Suppressor

BANK: SIMUL

14. VO+GT AMP

This algorithm is for use when simultaneously recording a vocal and electric guitar.

For the guitar, you can produce an amp sound using a preamp and speaker simulator.

(GUITAR)

–[COMP]–[PAMP]–[SP]–[NS]–[DLY]–

(MIC)

–[COMP]–[EQ]–[NS]–[DLY]–

(GUITAR)

Compressor

PreAmp

Speaker Simulator

Noise Suppressor

Delay

(MIC)

Compressor

4Band Equalizer

Noise Suppressor

Delay

15. VO+AC.SIM

This algorithm is for use when simultaneously recording a vocal and electric guitar.

For the guitar, you can make the electric guitar sound like an acoustic guitar.

(GUITAR)

–[ASIM]–[COMP]–[NS]–[DLY]–

(MIC)

–[COMP]–[EQ]–[NS]–[DLY]–

(GUITAR)

Acoustic Guitar Simulator

Compressor

Noise Suppressor

Delay

(MIC)

Compressor

4Band Equalizer

Noise Suppressor

Delay

16. VO+ACOUSTIC

This algorithm is for use when simultaneously recording a vocal and acoustic guitar.

For the guitar, you can produce a warm sound as though a mic were being used, even when an electric-acoustic is connected by a direct line.

(GUITAR)

–[ACP]–[COMP]–[NS]–

(MIC)

–[COMP]–[NS]–

(GUITAR)

Acoustic Processor

Compressor

Noise Suppressor

(MIC)

Compressor

Noise Suppressor

Parameter List

The trademarks listed in this document are trademarks of their respective owners, which are separate companies from BOSS. Those companies are not affiliated with BOSS and have not licensed or authorized BOSS's BR-900CD. Their marks are used solely to identify the equipment whose sound is simulated by BOSS's BR-900CD.

Acoustic Guitar Simulator

This simulates the sound of an acoustic guitar. It allows you to use an electric guitar to produce sounds similar to those of an acoustic guitar.

If you set the pickup selector of your guitar to the front position, the desired effect will be easier to achieve.

On/Off OFF, ON
This parameter turns the acoustic guitar simulator effect on/off.

PickUp SINGLE, HUMBUCK
Set this to the type of pickup on the connected guitar.

Charct
This selects one of the four types of sounds.

STD (standard):
This is a normal acoustic guitar.

JUMBO:
This is an acoustic guitar with a body that is bigger than STANDARD. The bass sound is powerful.

ENHANCE:
This is an acoustic guitar that with a more responsive attack, so the guitar will retain more of its prominence in almost any situation.

PIEZO:
This simulates the sound you would get from a pickup installed on an electric-acoustic guitar.
During the attack, a certain amount of compression will be applied.

Top-Hi -100+100
Adjust the level of the direct sound from the strings. That is, it adjusts the harmonic contents.

Top-Mid -100+100
This adjusts the interference to the strings made by the top plate. That is, it adjusts the attack sense.

Body -100+100
This adjusts the resonance of the sound caused by the body. That is, it adjusts the softness and fatness of the sound which is the typical characteristics of acoustic guitars.

Level 0-100
This adjusts the volume of the acoustic guitar simulator.

* If Top-Hi, Top-Mid, and Body are all set to "-100," there will be no sound.

Acoustic Processor

With this feature, you can change the sound from a pickup on an electric-acoustic guitar into a richer sound, similar to that obtained by a microphone placed near a guitar. Best results will be achieved when stereo recording.

On/Off OFF, ON
This parameter turns the acoustic processor effect on/off.

Body 0-100
This adjusts the resonance of the sound caused by the body. That is, it adjusts the softness and fatness of the sound which is the typical characteristics of acoustic guitars.

Mic Dist 0-100
This simulates the distance between the microphone capturing the sound of an acoustic guitar and the guitar itself.

Level 0-100
This adjusts the volume of the acoustic processor.

Bass Simulator

Simulates the sound of a bass guitar. Obtain the sound of a bass guitar while playing an electric guitar. You should avoid playing chords when using the Bass Simulator.

On/Off OFF, ON
This parameter turns the bass simulator effect on/off.

Charct LOOSE, TIGHT
Bass tone characteristic is set. When "LOOSE" is selected, as if the string gauge was getting thicker.

Level 0-100
This adjusts the volume of the bass simulator.

Chorus

A sound with a subtly shifted pitch is added to the direct sound, making the final output sound thicker and broader. Best results will be achieved when stereo recording.

* This effect can be used when the MODULATION "Type" parameter is set to "CHORUS."

On/Off OFF, ON

This parameter turns the chorus effect on/off.

Rate 0–100

Adjusts the rate of the Chorus effect.

Depth 0–100

Adjusts the depth of the Chorus effect.

Pre Dly 0.5–50.0 ms

Adjusts the time needed for the effect sound to be output after the direct sound has been output.

E.Level 0–100

Adjusts the volume of the effect sound.

Compressor

This corrects differences in input to create a steadier, more even volume balance. This is used to extend the sustain of input sounds and, conversely, to shorten sustain and emphasize the attack portion of sounds.

Another use of compression is as a "limiter," which prevents distortion by suppressing only volume peaks.

On/Off OFF, ON

This parameter turns the compressor effect on/off.

Sustain 0–100

This adjusts the depth of the effect. Higher settings values result in longer sustain times. Set this to a lower value when using compression for the limiter effect.

Attack 0–100

Adjusts the strength of the attack. Larger values will result in a sharper attack, creating a more clearly defined sound.

Level 0–100

Adjusts the volume.

COSM Comp (compressor)/Limiter

The compressor corrects differences in input to create a steadier, more even volume balance. It is used to extend the sustain of input sounds and, conversely, to shorten sustain and emphasize the attack portion of sounds.

The limiter is an effect that prevents distortion by suppressing input signals that exceed a set value (threshold). You can get the same effect achieved with the compressor by setting the threshold at a low value. The BR-900CD uses COSM technology to model four types of compressor/limiter in which the compressor and limiter functions are combined.

On/Off OFF, ON

Sets the compressor/limiter to ON or OFF.

Type

Selects the compressor/limiter type.

BOSS-Cmp: Models the BOSS CS-3 compact effects processor.

D-Comp: Models the MXR dyna comp.

Rack160: Models the dbx 160.

VtgRack: Models the UREI 1178.

Attack (with BOSS-Cmp, D-Comp) 0–100

Adjusts the strength of the picking attack when the strings are played. Larger values will result in a sharper attack, creating a more clearly defined sound.

Sustain (with BOSS-Cmp, D-Comp) 0–100

Boosts low-level signals, adjusting the time over which sounds are sustained. Higher values deepen the effect, resulting in a longer sustain.

Threshold (with Rack160) 0–100

Adjust this as appropriate for the input signal from your bass. The compression effect is applied to input above the level set here. The smaller the value set here, the lower the level at which the limiter effect kicks in.

Input (with VtgRack) 0–100

Controls the input level. Increasing the value will produce a deeper effect.

Ratio (with Rack160) 1:1–20:1, INF:1 (with VtgRack) 4:1–20:1

Adjusts the limiter compression ratio. Higher ratio create a stronger compression effect.

Attack Time (When set to VtgRack) 0–100

This adjusts the amount of time it takes for the compression ratio set in Ratio to be reached once compression begins, as the input level exceeds the set threshold level. The larger the value set here, the more rapidly compression is applied.

Release Time (with VtgRack) 0–100

This adjusts the time from when the signal level drops below the threshold until when the compression is removed. The lower the values set, the more rapidly the compression is released, and the more clearly the sound from the next string played is heard.

Tone (with BOSS-Cmp) -50–+50

Adjusts the tone. The higher the value set, the more the high frequencies are boosted, resulting in a harder sound.

Level 0–100

Adjusts the volume.

De-esser

Useful for reducing 'sibilant' or 'S' sounds produced by a vocalist.

On/Off OFF, ON

This parameter turns the de-esser effect on/off.

Sibilant 0–100

Adjusts the sensitivity relative to the input volume, which controls how the effect is applied.

Level 0–100

Adjusts the volume.

Defretter

This simulates a fretless bass.

On/Off OFF, ON

This parameter turns the defretter effect on/off.

Sens 0–100

This controls the input sensitivity of the Defretter. It should be adjusted for the bass guitar you have until you get the harmonic changes to sound natural.

Attack 0–100

This controls the attack of the Defretter. Increasing the value will cause the harmonics to change more slowly, thus producing a relatively attack-less sound, similar to a fretless bass.

Depth 0–100

This controls the ratio of harmonics. Increasing the value will increase the harmonic content and therefore will create a more unusual sound.

Level 0–100

Adjusts the volume of the defretter sound.

Delay

This creates a thicker sound by applying a delayed sound to the direct sound.

On/Off OFF, ON

This parameter turns the delay effect on/off.

Type

This Parameter selects the type of delay.

* This parameter cannot be selected with the "VO+GT AMP" and "VO+AC.SIM" algorithms.

SINGLE:

This is a simple delay.

TAP:

The delayed sound is panned across the left and right channels. This will be effective when stereo recording.

Dly Tme SINGLE: 1–1400 ms, TAP: 1–700 ms

This parameter adjusts the delay time (i.e., the interval for which sound is delayed).

Feedback 0–100

This parameter adjusts the amount of feedback. Changing the amount of feedback causes the number of time the delayed sound is repeated to change as well.

E.Level 0–120

Adjusts the volume of the delay sound.

Doubling

By adding a slightly time-delayed sound to the direct sound, this produces the impression that multiple sources are sounding together (a "doubling" effect). Best results will be achieved when stereo recording.

* This effect can be used when the MODULATION "Type" parameter is set to "DOUBLING."

On/Off OFF, ON

This parameter turns the doubling effect on/off.

Dly Tme 0.5–50.0 ms

This parameter adjusts the delay time (i.e., the interval for which sound is delayed).

Separation -50– +50

Adjusts the diffusion. The panning of the direct sound and effect sound can be spread to left and right.

* This effect is obtained with stereo recording (using two tracks).

E.Level 0–120

This adjusts the volume of the delay sound.

Enhancer

By adding sounds which are out-of-phase with the direct sound, this effect enhances the definition of the sound, and pushes it to the forefront.

On/Off OFF, ON

This parameter turns the enhancer effect on/off.

Sens 0–100

Adjusts the manner in which the enhancer will be applied relative to the input signals.

Freq 1.0–10.0 kHz

Adjusts the frequency at which the enhancer effect will begin to be applied. The effect will be made apparent in the frequencies above the frequency set here.

Mix Level 0–100

Adjusts the amount of phase-shifted sound of the range set by "Frequency" that is to be mixed with the input.

Lo Mix Lvl 0–100

Adjusts the amount of phase-shifted sound of the lower range that is to be mixed with the input. The frequency range in which the effect is applied is fixed.

Level 0–100

Adjusts the volume of the enhanced sound.

Equalizer

A 4-band equalizer.

* You can use this effect with the following algorithms when "4BAND EQ" is selected for the 4BAND EQ/WAH "Type" setting.

COSM GTR AMP	COSM BASS AMP
COSM COMP GTR	COSM COMP BSS
BASS MULTI	STEREO MULTI

On/Off OFF, ON

This parameter turns the equalizer effect on/off.

Low Gain -20+ +20 dB

This parameter sets the gain (amount of boost or cut) for the bass equalizer.

Lo-M Gin -20+ +20 dB

This parameter sets the gain (amount of boost or cut) for the low-midrange equalizer.

Lo-M F 100 Hz–10.0 kHz

This parameter sets the central frequency for the low-midrange equalizer.

Lo-M Q 0.5–16

This parameter sets the range of change in gain for the frequency set by "Lo-M F." A larger value results in a narrower range of change.

Hi-M Gin -20+ +20 dB

This parameter sets the gain (amount of boost or cut) for the high-midrange equalizer.

Hi-M F 100 Hz–10.0 kHz

This parameter sets the central frequency for the high-midrange equalizer.

Hi-M Q 0.5–16

This parameter sets the range of change in gain for the frequency set by "Hi-M F." A larger value results in a narrower range of change.

Hi Gain -20+ +20 dB

This parameter sets the gain (amount of boost or cut) for the treble equalizer.

Level -20+ +20 dB

This parameter adjusts the volume after the equalizer stage.

Flanger

This produces a flanging effect that gives a sort of "twisting" character to the sound.

* This effect can be used when the MODULATION "Type" parameter is set to "FLANGER."

On/Off OFF, ON

This parameter turns the flanger effect on/off.

Rate 0–100

Determines the rate of the flanging effect.

Depth 0–100

Determines the depth of the flanging effect.

Manual 0–100

Adjusts the center frequency at which to apply the effect.

Resonance 0–100

Determines the amount of resonance (feedback). Increasing the value will emphasize the effect, creating a more unusual sound.

Separation 0–100

Adjusts the diffusion. The diffusion increases as the value increases. This will be effective when stereo output is used.

* This effect is obtained with stereo recording (using two tracks).

Foot Volume

Specify the volume between effects.

By using an expression pedal to control the foot volume, you can smoothly change the volume of the output sound. For a detailed explanation, see "When Using an Expression Pedal" (p. 187).

On/Off OFF, ON

Switches the foot volume on/off.

Lo-Fi Box

Produces a lo-fi sound.

On/Off OFF, ON

This parameter turns the lo-fi box effect on/off.

Type

Select the mode of the lo-fi box.

RADIO:

The sound will appear to be heard from an AM radio.

* By adjusting "Tuning," you can simulate the sounds that occur when you adjust the tuning frequency of the radio.

PLAYER:

The sound will appear to be heard from a gramophone. The noise caused by scratches and dust on the record are simulated.

DIGITAL:

This allows you to create a "lo-fi" sound by lowering the sample rate and/or decreasing the number of bits. Realtime modify filters connected in series allow you to reshape the sound freely.

■ When "RADIO" or "PLAYER" is selected

Tuning 0–100

This is a parameter for "RADIO." It simulates the sounds that occur when you adjust the tuning frequency of an AM radio.

Wow Flt 0–100

This is a parameter for "PLAYER." It simulates the wow and flutter which occur when the speed of the turntable is not constant.

Noise 0–100

This simulates noise.

Filter 0–100

Adjusts the filter.

D:E 100:0–0:100

This adjusts the volume balance of the direct and effect sounds.

■ When “DIGITAL” is selected

Pre Filter OFF, ON

This filter decreases digital distortion. When turned off, you can create an intense lo-fi sound incorporating digital distortion.

Smpl Rate OFF, 1/2–1/32

Modify the sample rate.

Bit OFF, 15–1

Modify the number of data bits. If this is turned off, the number of data bits will be unchanged. If an extremely low number of bits is selected, loud noise may appear even when there is no sound, depending on the input source. In such cases, raise the threshold of the noise suppressor.

Post Fltr OFF, ON

This filter decreases the digital distortion produced by lo-fi. By turning this off, you can create an extremely lo-fi sound.

Fx Level 0–100

Adjust the volume of the lo-fi sound.

Dir Level 0–100

Adjusts the volume of the direct sound.

Modify Fil

This is a filter featuring a wide range of possible settings (modifiable filter). Select different types to get a variety of different filter effects.

OFF:
The modify filter will not be used.

LPF:
The effect will function as a low pass filter.

BPF:
The effect will function as a band pass filter.

HPF:
The effect will function as a high pass filter.

Cutoff F 0–100

Adjust the cutoff frequency.

Resonance 0–100

Adjust the resonance.

Gain 0–24 dB

Adjust the volume level of the sound that has passed through the modify filter.

Noise Suppressor

This effect reduces the noise and hum. Since it suppresses the noise in synchronization with the envelope of the sound (the way in which the sound decays over time), it has very little effect on the sound, and does not harm the natural character of the sound.

On/Off OFF, ON

This parameter turns the noise suppressor effect on/off.

Threshold 0–100

Adjust this parameter as appropriate for the volume of the noise. If the noise level is high, a higher setting is appropriate. If the noise level is low, a lower setting is appropriate. Adjust this value until the decay of the sound is as natural as possible.

* High settings for the Threshold parameter may result in there being no sound when you play with your instruments volume turned down.

Release 0–100

Adjusts the time from when the noise suppressor begins to function until volume reaches “0.”

Octave

This adds a note one octave lower, creating a richer sound.

On/Off OFF, ON

This parameter turns the octave effect on/off.

Oct Level 0–100

This adjusts the volume of the sound one octave below.

Dir Level 0–100

Adjusts the volume of the direct sound.

Phaser

By adding varied-phase portions to the direct sound, the phaser effect gives a whooshing, swirling character to the sound.

* This effect can be used when the MODULATION “Type” parameter is set to “PHASER.”

On/Off OFF, ON

This parameter turns the phaser effect on/off.

Rate 0–100

This sets the rate of the Phaser effect.

Depth 0–100

Determines the depth of the Phaser effect.

Manual 0–100

Adjusts the center frequency of the phaser effect.

Resonance 0–100

Determines the amount of resonance (feedback). Increasing the value will emphasize the effect, creating a more unusual sound.

Pitch Shifter

This effect changes the pitch of the original sound (up or down) within a range of two octaves.

* This effect can be used when the MODULATION "Type" parameter is set to "PITCH SFT."

On/Off **OFF, ON**

This parameter turns the pitch shifter effect on/off.

Type

Selects either manual pitch shifter "MANUAL" or pedal pitch shifter "PEDAL."

MANUAL:

This is a simple pitch shifter.

PEDAL:

The effect will function as a pedal pitch shifter. The effect of the wah pedal can be obtained by operating the Expression pedal.

For a detailed explanation, see "When Using an Expression Pedal" (p. 187).

Pitch **-24-DETUNE- +24**

Adjusts the amount of pitch shift (the amount of pitch change) in semitone steps. By selecting "DETUNE," you can add a slightly pitch-shifted sound to the input sound, producing a detune effect.

* This effect can be used when the "P.Shift Type" parameter is set to "MANUAL."

D:E **100:0-0:100**

This adjusts the volume balance of the direct and effect sounds.

Separation **-50- +50**

Adjusts the diffusion. The panning of the direct sound and effect sound can be spread to left and right. This will be effective when stereo output is used.

Preamp

Adjust the distortion and tone of the guitar sound.

* When all Bass, Middle and Treble are set to "0," no sound may be produced depending on the "Type" setting.

On/Off **OFF, ON**

Turns the preamp effect on/off.

Type

This sets the type of the preamp. The distortion and tone characteristics of each amp are as shown below:

■ With "COSM GTR AMP," "COSM COMP GTR," or "VO+GT AMP" algorithms

JC-120	The sound of the Roland "JC-120," a favorite of pro musicians around the world.
CLEAN	The sound of a conventional built-in tube amp.
CRUNCH	Allows you to obtain a crunch effect that creates a natural distortion.
MATCH	A simulation of the latest tube amp widely used in styles from blues and rock.
VO DRV	Allows you to obtain the Liverpool sound of the 60's.
BLUES	A lead sound with a rich middle ideal for Blues.
BG LEAD	The sound of a tube amp typical of the late '70s to '80s, characterized by a distinctive mid-range.
MS (1, 2, 1+2)	The sound of a large tube amp stack that was indispensable to the British hard rock of the 70's, and is used to this day by many hard rock guitarists.
1	A trebly sound created by using input I of the guitar amp.
2	A trebly sound created by using input II of the guitar amp.
1 + 2	The sound of connecting inputs I and II of the guitar amp in parallel, creating a sound with a stronger low end than I.
SLDN	A tube amp sound with versatile distortion, usable in a wide range of styles.
METAL	The sound of a large tube amp, suitable for heavy metal.
METAL D	A high gain and powerful metal sound.

■ With "COSM BASS AMP" or "COSM COMP BSS" algorithms

AC	It produces the vintage sound of an early transistor amp.
AMG	It produces the sound of a large double-stack vacuum tube amp with ultra-lows and a crisp edge.

Volume 0–100
Adjusts the volume and distortion of the amp.

Bass **GUITAR AMP: 0–100, BASS AMP:-100– +100**
Adjusts the tone for the low frequency range.

Middle **GUITAR AMP: 0–100, BASS AMP:-100– +100**
Adjusts the tone for the middle frequency range.

* If you have selected "MATCH" or "VO DRV" as the type, the middle control will have no effect.

Treble **GUITAR AMP: 0–100, BASS AMP: -100– +100**
Adjusts the tone for the high frequency range.

Presence 0–100
This can be selected in the "COSM GTR AMP," "COSM COMP GTR," or the "VO+GT.AMP" algorithm.
Adjusts the tone for the ultra high frequency range.

* If you have selected "MATCH" or "VO DRV" as the type, raising presence will cut the high range (the value will change from "0" to "100").

Master 0–100
Adjusts the volume of the entire preamp.

Bright OFF, ON
(with JC-120, CLEAN, CRUNCH, BLUES, BG LEAD, AC, AMG)
Turns the bright setting on/off.

OFF:
Bright is not used.

ON:
Bright is switched on to create a lighter and crisper tone.

Gain LOW, MIDDLE, HIGH
Adjusts the distortion of the amp. Distortion will successively increase for settings of "LOW," "MIDDLE" and "HIGH."

* The sound of each Type is created on the basis that the Gain is set to "MIDDLE." So, normally set it to "MIDDLE."

Ring Modulator

This creates a bell-like sound by ring-modulating the guitar sound with the signal from the internal oscillator. The sound will be unmusical and lack distinctive pitches.

On/Off OFF, ON
This parameter turns the ring modulator effect on/off.

Frequency 0–100
This adjusts the frequency of the internal oscillator.

Fx Level 0–100
Adjusts the volume of the effect sound.

Dir Level 0–100
Adjust the volume of the direct sound.

Slow Attack

This produces a volume-swell effect ("violin-like" sound).

* This effect can be used in the "COSM GTR AMP" algorithm when the MODULATION "Type" parameter is set to "SLOW ATCK."

On/Off OFF, ON
This parameter turns the slow attack effect on/off.

RiseTme 10–2000 ms
This adjusts the time needed for the volume to reach its maximum from the moment you begin picking.

Level 0–100
Adjust the volume of the slow attack sound.

Speaker Simulator

This simulates the characteristics of various types of speakers. When the output of the BR-900CD is connected directly to a mixer, etc., this can be used to create the sound of your favorite speakers system.

On/Off **OFF, ON**

This parameter turns the speaker simulator effect on/off.

Type

Selects the type of speaker that will be simulated.

* "On Mic" simulates the sound when a dynamic microphone is used, and "Off Mic" simulates the sound when a condenser microphone is used.

■ With "COSM GTR AMP," "COSM COMP GTR," or "VO+GT AMP" algorithms

SP Simulator Type	Cabinet	Speaker Unit	Microphone Setting	Comments
SMALL	Small open-back enclosure	10 inch	On Mic	
MIDDLE	Open-back enclosure	12 inch	On Mic	
JC-120	Open-back enclosure	12 inch (two units)	On Mic	Roland JC-120 Simulation
TWIN	Open-back enclosure	12 inch (two units)	On Mic	A setting suitable for CLEAN
twin	Open-back enclosure	12 inch (two units)	Off Mic	A setting suitable for CLEAN
MATCH	Open-back enclosure	12 inch (two units)	On Mic	A setting suitable for MATCH
match	Open-back enclosure	12 inch (two units)	Off Mic	A setting suitable for MATCH
VO DRV	Open-back enclosure	12 inch (two units)	On Mic	A setting suitable for VO DRV
vo drv	Open-back enclosure	12 inch (two units)	Off Mic	A setting suitable for VO DRV
BG STK	Large Sealed enclosure	12 inch (two units)	On Mic	A setting suitable for BG LEAD
bg stk	Large sealed enclosure	12 inch (two units)	Off Mic	A setting suitable for BG LEAD
MS STK	Large sealed enclosure	12 inch (four units)	On Mic	A setting suitable for MS
ms stk	Large sealed enclosure	12 inch (four units)	Off Mic	A setting suitable for MS
METAL	Large dual stack	12 inch (four units)	Off Mic	

■ With "COSM BASS AMP" or "COSM COMP BSS" algorithms

SP Simulator Type	Cabinet	Speaker Unit	Microphone Setting	Comments
AC	Large sealed enclosure	15 inch (two units)	On Mic	A setting suitable for AC
ac	Large sealed enclosure	15 inch (two units)	Off Mic	A setting suitable for AC
AMG	Large sealed enclosure	10 inch (eight units)	On Mic	A setting suitable for AMG
amg	Large sealed enclosure	10 inch (eight units)	Off Mic	A setting suitable for AMG

Mic Set **CENTER, 1–10 cm**

This simulates the microphone position. "CENTER" simulates the condition that the microphone is set in the middle of the speaker cone. "1–10 cm" means that the microphone is moved away from the center of the speaker cone.

Mic Level **0–100**

Adjusts the volume of the microphone.

Dir Level **0–100**

Adjust the volume of the direct sound.

Tremolo/Pan

Tremolo is an effect that creates a cyclic change in volume. Pan cyclically moves the stereo position between left and right (when stereo output is used).

* This effect can be used when the MODULATION "Type" parameter is set to "TRM/PAN."

On/Off **OFF, ON**

This parameter turns the tremolo/pan effect on/off.

Mode

Selects tremolo or pan; also selects how the effect is applied

TRM-TRI:

The volume will change cyclically. Smooth change will be produced.

TRM-SQR:

The volume will change cyclically. Abrupt change will be produced.

PAN-TRI:

The sound will be moved cyclically between left and right. Smooth change will be produced.

PAN-SQR:

The sound will be moved cyclically between left and right. Abrupt change will be produced.

* "PAN-TRI" and "PAN-SQR" are obtained with stereo recording (using two tracks).

Rate **0–100**

Adjust the rate at which the effect will operate.

Depth **0–100**

Adjusts the depth of the effect.

Voice Transformer

This controls the formants, allowing a variety of voice characters to be created. This adds two voice characters with differing formants to the direct sound.

On/Off **OFF, ON**

This parameter turns the voice transformer effect on/off.

Formant1 **-100– +100**

Adjust the formant of the voice character 1.

Formant2 **-100– +100**

Adjust the formant of the voice character 2.

FX1 Level **0–100**

Adjust the volume of the voice character 1.

FX2 Level **0–100**

Adjust the volume of the voice character 2.

Dir Level **0–100**

Adjust the volume of the direct sound.

Wah

The wah effect creates a unique tone by changing the frequency response characteristics of a filter.

Touch wah creates an automatic wah by changing the filter in response to the volume of the input. Pedal wah lets you use an Expression pedal or the like to obtain real-time control of the wah effect.

* You can use this effect with the following algorithms when "WAH" is selected for the 4BAND EQ/WAH "Type" setting.

COSM GTR AMP	COSM BASS AMP
COSM COMP GTR	COSM COMP BSS
BASS MULTI	STEREO MULTI

On/Off OFF, ON

Turns the touch wah/pedal wah effect on/off.

Type

Selects either touch wah "TOUCH" or pedal wah "PEDAL."

TOUCH:

The effect will function as a touch wah.

PEDAL:

The effect will function as a pedal wah.

■ When "TOUCH" is selected

Polarity

Selection for the direction in which the filter will change in response to the input.

UP:

The frequency of the filter will rise.

DOWN:

The frequency of the filter will fall.

Sens 0–100

This adjusts the sensitivity at which the filter will change in the direction determined by the polarity setting. Higher values will result in a stronger response. With a setting of "0," the strength of picking will have no effect.

Frequency 0–100

This adjusts the center frequency of the Wah effect.

Peak 0–100

This adjusts the amount of wah effect applied. Lower values provide a mild wah effect, while higher values result in a sharper wah sound. With a value of "50" a standard wah sound will be produced.

Level 0–100

Adjusts the volume.

■ When "PEDAL" is selected

The effect of the wah pedal can be obtained by operating the Expression pedal.

For a detailed explanation, refer to "When Using an Expression Pedal" (p. 187).

Peak 0–100

This adjusts the amount of wah effect applied. Lower values provide a mild wah effect, while higher values result in a sharper wah sound. With a value of "50" a standard wah sound will be produced.

Level 0–100

Adjusts the volume.

Mastering

Use the “Mastering Tool Kit” to produce a two-track master of the bounce tracks with the levels optimized.

What is Mastering Tool Kit?

When creating an audio CD from your recorded songs, or recording to an MD or similar media, the overall volume needs to be restrained, so that even the loudest portions of the songs are handled appropriately on the CD or MD. However, this often results in an overall lowering of the volume, resulting in a CD or MD that lacks excitement and impact.

Moreover, in the low-frequency range, to which the human ear is not very sensitive, the sound actually produced might be perceived as being somewhat low in volume, even though the meter shows that it’s at the maximum level. This also makes it difficult to create powerful sounds.

With the “Mastering Tool Kit,” however, you can smooth out the differences in volume that occur over the course of a song, while also correcting the balance in the low end.

We recommend mastering with the Mastering Tool Kit in the final stage of creating songs.

- * The Mastering Tool Kit features 19 pre-programmed “Preset Patches” (P01–P19), 19 rewritable “User Patches” (U01–U19), and 19 “Song Patches,” which are stored individually for each song (S01–S19).

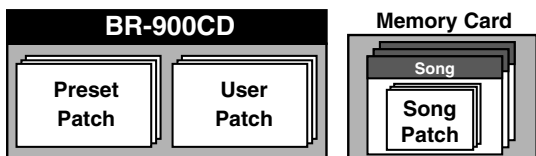

“Mastering Tool Kit Patch List” (p. 205)

- * In Mastering mode, the following buttons are disabled after you set the recording source and destination and return to the Play screen. In addition, you cannot change the point to which the insert effects are connected (p. 87).

[INPUT SELECT], [TUNER], [PAN/EQ],
 [LOOP EFFECTS], [PITCH CORRECTION],
 [PHRASE TRAINER],
 [ARRANGE/PATTERN/OFF], [EDIT],
 [RHYTHM PAD], [V-TRACK], [DELETE/MUTE]

1. Press [REC MODE] several times until “MASTERING” is indicated for REC MODE at the left of the screen.
2. Turn the TIME/VALUE dial to select the recording source V-Track, and then press [ENTER].
 The Mastering screen appears in the display.

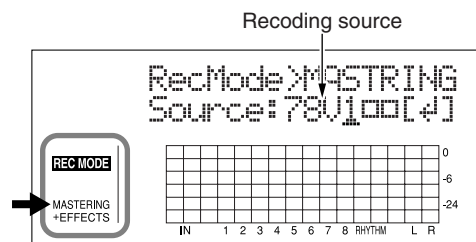

- : V-Tracks with recorded data.
- : V-Tracks without data.

- * At this point, the Mastering Tool Kit is automatically selected as the effect.

3. Press CURSOR [◀] [▶] to move the cursor to the recording-destination V-track and turn the TIME/VALUE dial to select the V-Track.

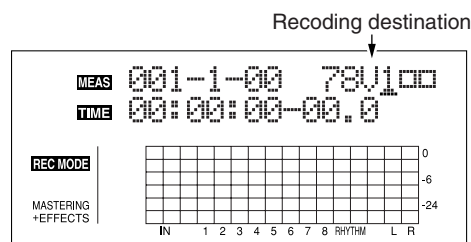

The REC TRACK button for the track selected as the recording destination flashes in red.

4. Press [EFFECTS].

The Mastering Tool Kit selection screen appears in the display.

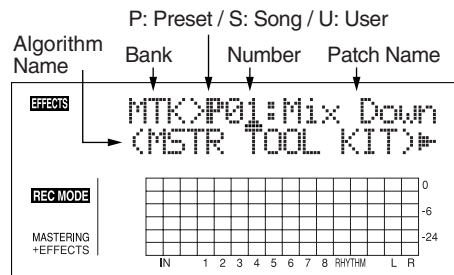

- Use the TIME/VALUE dial to select the Preset/Song/ User patch and number for the Mastering Tool Kit.



“Mastering Tool Kit Patch List” (p. 205)

- Press [EXIT] to return to the Play screen.
The overall volume is adjusted by the MASTER fader. At this time, raise the volume as high as possible without allowing the sound to distort.
- Press [REC].
[REC] flashes in red and the BR-900CD enters the recording standby state.

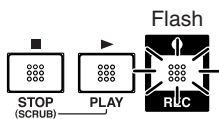

- Press [PLAY].
[REC] stop flashing in red and instead light solidly, and recording starts.

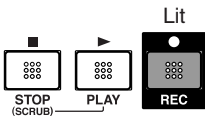

- When you finish mastering, press [STOP].
* During updating, “Keep power on!” appears in the upper line of the display, while the lower line shows what is being processed.

Editing the Mastering Tool Kit Settings

To create a new patch, select the patch that most closely resembles the sound you have in mind from the effects patches already stored in the unit, then edit its settings. If you wish to save the effect settings that you edited, save them as a user patch or song patch.

- Carry out Steps 1–3 from p. 102, and switch to Mastering mode.
- Press [EFFECTS] (MASTERING TOOL KIT).
The Mastering Tool Kit selection screen appears.

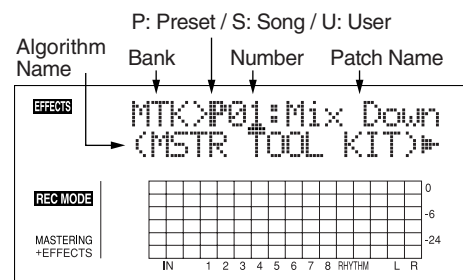

- Use the TIME/VALUE dial to select the Preset/Song/ User and number.
- Press CURSOR [>] to move the cursor to “EDIT,” and press [ENTER].
The display switches to the Mastering Tool Kit Edit screen, which shows the algorithm (the effects used, shown in the sequence they are connected).

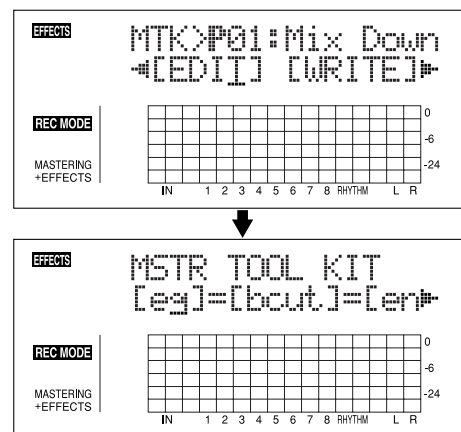

You can also display this screen directly by pressing [ENTER] while the cursor is positioned at the Preset/Song/ User or number.

5. Press CURSOR [◀] [▶] to move the cursor to each effect and turn the TIME/VALUE dial to turn each effect on or off.

Blocks that are turned on are shown in uppercase letters, while blocks that are turned off are shown in lowercase letters. Turn on the effects that you want to use.

6. Press CURSOR [◀] [▶] to move the cursor to the effect with the parameter that you want to change and press [ENTER].

The Parameter Setting screen for each effect appears.

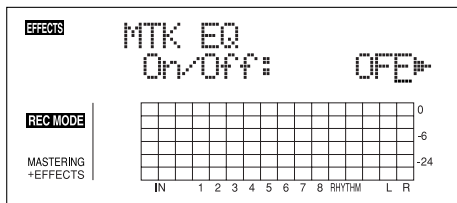

7. Use CURSOR [◀] [▶] to select a parameter, and turn the TIME/VALUE dial to edit the value.
8. If you would like to edit another effect, press [EXIT] to return to the previous screen, and repeat steps 5-6.
9. If you wish to save the current effect settings, perform the procedure described in "Saving Mastering Tool Kit Settings," below.

NOTE

Edited effect settings are temporary. If you exit the Edit Effect screen without saving the effect patch you changed, "TMP" appears next to the indication of the bank.

Be aware that if you select a new effect patch while "TMP" is displayed, the altered effect patch is returned to its original settings and the changes are lost.

Saving the Mastering Tool Kit Settings (Write)

This assigns a name (patch name) to the edited patch settings and saves the settings.

- * You cannot write patches while songs are being recorded or played back.
- * If you do not need to change patch name, go to step 4.

1. At the Mastering Tool Kit selection screen, press CURSOR [▶] to move the cursor to "NAME," and press [ENTER].

The Patch Name Setting screen appears.

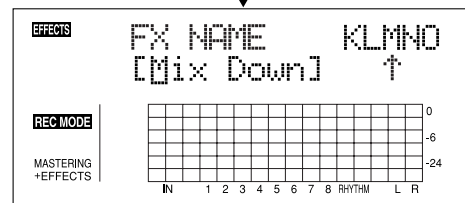
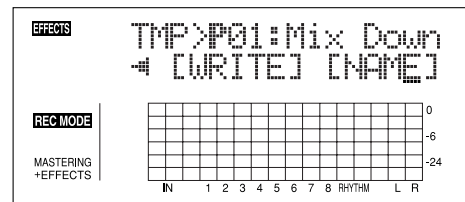

2. Use CURSOR [◀] [▶] and the TIME/VALUE dial to enter the patch name.

* Press [ENTER] to switch between uppercase and lowercase.

3. After you have completed entering the effect settings and patch name as desired, press [EXIT] to return to the Kit Selection screen.

4. Press CURSOR [◀] [▶] to move the cursor to "WRITE," and press [ENTER].

The Write screen appears.

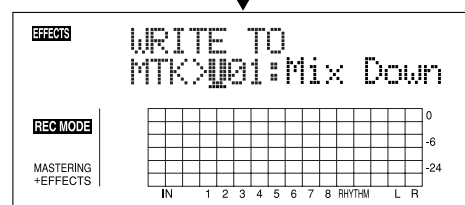
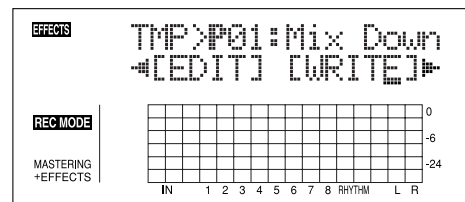

5. Turn the TIME/VALUE dial to select the patch number to which to write the new patch.

6. After you've selected the destination, press [ENTER].

After the save has been completed, you are returned to the Mastering Tool Kit selection screen.

* During updating, "Keep power on!" appears in the upper line of the display, while the lower line shows what is being processed.

Mastering Tool Kit Parameter Functions

Algorithm

[EQ]=[BCUT]=[ENH]=[IN]=[EXP]
[COMP]=[MIX]=[LIM]=[OUT]

Equalizer

Bass Cut Filter

Enhancer

Input

Expander

Compressor

Mixer

Limiter

Output

Parameter List

Equalizer

On/Off OFF, ON

This parameter turns the equalizer effect on/off.

Input Gain -24 – +12 dB

Sets the overall volume before passing through the equalizer.

Low Type SHELVG, PEAK

Sets the equalizer type (shelving, peaking) for the lower range.

Low Gain -12 – +12 dB

Sets the amount of boost or cut in the lower range.

Low Freq 20 Hz–2.0 kHz

Sets the center frequency for the lower range.

Low Q 0.3–16.0

Sets the steepness of the frequency response curve for the lower range's center frequency. (*1)

Low Mid Gain -12– +12 dB

Sets the amount of boost or cut in the mid-low range.

Low Mid Freq 20 Hz–8.0 kHz

Sets the center frequency for the mid-low range.

Low Mid Q 0.3–16.0

Sets the steepness of the frequency response curve for the mid-low range's center frequency.

High Mid Gain -12– +12 dB

Sets the amount of boost or cut in the upper-low range.

High Mid Freq 20 Hz–8.0 kHz

Sets the center frequency for the upper-midrange.

High Mid Q 0.3–16.0

Sets the steepness of the frequency response curve for the upper-low range's center frequency.

High Type SHELVG, PEAK

Sets the equalizer type (shelving, peaking) for the upper range.

High Gain -12– +12 dB

Sets the amount of boost or cut in the upper range.

High Freq 1.4–20.0 kHz

Sets the center frequency for the upper range.

High Q 0.3–16.0

Sets the frequency response curve steepness for the upper range's center frequency. (*1)

Output Gain -24– +12 dB

Sets the overall volume level after equalization.

(*1) The Low Q/Hi Q setting is disabled when "SHELVG" (shelving type equalization) is selected for the Low Type or High Type.

Mastering Tool Kit Parameter Functions

Bass Cut Filter

This is a filter that cuts unwanted low range noise, such as pops.

On/Off OFF, ON

This setting turns the Bass Cut Filter on/off.

Freq 20 Hz–2.0 kHz

This sets the frequency containing popping or other undesirable lower-range noises that you want to cut.

Enhancer

This adds more liveliness to the sound, putting sounds at the forefront.

On/Off OFF, ON

This parameter turns the enhancer effect on/off.

Sens 0–100

This sets the amount of Enhancer that is applied.

Freq 1.0–10.0 kHz

Sets the frequency at which the enhancer effect will begin to be applied.

Mix Lvl -24– +12 dB

Sets the volume of the effect sound.

Input

This divides the original sound into three frequency ranges: low, mid, and high.

Gain -24– +12 dB

Sets the overall volume level before the signal passes through the expander/compressor.

Dly Time 0–10 ms

This sets the amount of time by which the source input sound is delayed.

SplitL 20–800 Hz

This sets the frequency (in the lower range) at which the source sound is split into three separate ranges.

SplitH 1.6–16.0 kHz

This sets the frequency (in the upper range) at which the source sound is split into three separate ranges.

Expander

This expands the dynamic range at a fixed ratio.

On/Off OFF, ON

This setting turns the expander on/off.

Lo Thres -80–0 dB

This sets the volume level at which the lower-range expander goes into effect.

Lo Ratio 1:1.00–1:16.0, 1:INF

This sets the ratio of increase in output of the lower range when the input level falls below the Lo threshold level.

Lo Attack 0–100 ms

This sets the time it takes for the lower-range expander to go into effect once the input level falls below the Lo threshold level.

Lo Release 50–5000 ms

This sets the time it takes for the lower-range expander effect to stop once the input level exceeds the Lo threshold level.

Mid Thres -80–0 dB

This sets the volume level at which the midrange expander goes into effect.

Mid Ratio 1:1.00–1:16.0, 1:INF

This sets the ratio of increase in output of the midrange when the input level falls below the Middle threshold level.

Mid Attack 0–100 ms

This sets the time it takes for the midrange expander to go into effect once the input level falls below the Middle threshold level.

Mid Release 50–5000 ms

This sets the time it takes for the midrange expander effect to stop once the input level exceeds the Middle threshold level.

Hi Thres -80–0 dB

This sets the volume level at which the upper-range expander goes into effect.

Hi Ratio 1:1.00–1:16.0, 1:INF

This sets the ratio of increase in output of the upper range when the input level falls below the Hi threshold level.

Hi Attack 0–100 ms

This sets the time it takes for the upper-range expander to go into effect once the input level falls below the Hi threshold level.

Hi Release 50–5000 ms

This sets the time it takes for the upper-range expander effect to stop once the input level exceeds the Hi threshold level.

Compressor

This compresses the overall output signal when the input volume level exceeds a set value.

On/Off **OFF, ON**

This parameter turns the compressor effect on/off.

Lo Thres **-24-0 dB**

This sets the volume level at which the lower-range compressor goes into effect.

Lo Ratio **1:1.00-1:16.0, 1:INF**

This sets the ratio of suppression of the lower-range output when the input level exceeds the Lo threshold level.

Lo Attack **0-100 ms**

This sets the time it takes for the lower-range compressor to go into effect once the input level exceeds the Lo threshold level.

Lo Release **50-5000 ms**

This sets the time it takes for the lower-range compressor effect to stop once the input level falls below the Lo threshold level.

Mid Thres **-24-0 dB**

This sets the volume level at which the midrange compressor goes into effect.

Mid Ratio **1:1.00-1:16.0, 1:INF**

This sets the ratio of suppression of the midrange output when the input level exceeds the Middle threshold level.

Mid Attack **0-100 ms**

This sets the time it takes for the midrange compressor to go into effect once the input level exceeds the Middle threshold level.

Mid Release **50-5000 ms**

This sets the time it takes for the midrange compressor effect to stop once the input level falls below the Middle threshold level.

Hi Thres **-24-0 dB**

This sets the volume level at which the upper-range compressor goes into effect.

Hi Ratio **1:1.00-1:16.0, 1:INF**

This sets the ratio of suppression of the upper-range output when the input level exceeds the Hi threshold level.

Hi Attack **0-100 ms**

This sets the time it takes for the upper-range compressor to go into effect once the input level exceeds the Hi threshold level.

Hi Release **50-5000 ms**

This sets the time it takes for the upper-range compressor effect to stop once the input level falls below the Hi threshold level.

* *With the compressor, the level is automatically adjusted to the optimum setting according to the threshold (Thres) and ratio (Ratio) settings. In addition, since lengthening the attack (Attack) setting may result in distortion, a buffer (margin) of -6 dB is provided. Adjust the Mixer level as needed.*

Mixer

Adjusts the volume of each frequency band.

Lo Level **-80- +6 dB**

Sets the volume level of the lower range after the signal passes through the expander and compressor.

Mid Level **-80- +6 dB**

Sets the volume level of the midrange after the signal passes through the expander and compressor.

Hi Level **-80- +6 dB**

Sets the volume level of the upper range after the signal passes through the expander and compressor.

Limiter

This suppresses high-level signals to prevent distortion.

On/Off **OFF, ON**

Sets the limiter to ON or OFF.

Thres **-24-0 dB**

Adjust this as appropriate for the input signal from your bass.

Attack **0-100 ms**

This sets the time it takes for the limiter to go into effect once the input level exceeds the threshold level.

Release **50-5000 ms**

Adjusts the time until when the limiter will turn off after the input level falls below the threshold level.

Output

This makes settings that affect the overall output.

Level **-80- +6 dB**

Sets the volume level of the overall sound after the signal passes through the limiter.

Soft Clip **Off, On**

This suppresses noticeable distortion occurring with heavy use of the compressor/limiter effect.

Dither **OFF, 24-8 BIT**

This prevents the action of muting sounds from being too noticeable.

Using the Loop Effects/Track EQ

Here is an explanation of how to change the various parameters for the loop effects (chorus/delay/doubling/reverb).



For an explanation of loop effects, refer to “Loop Effect Parameter Functions” (p. 111).

MEMO

Loop effects do not have “patches.” Loop effect settings are saved along with the song data.

If you want to save the settings in the currently selected song, hold down [STOP], and press [REC].

Selecting the Loop Effect

* You cannot use the chorus, delay, and doubling effects together. You must choose only one.

1. Press [LOOP EFFECTS].
2. Press CURSOR [◀] [▶] to move the cursor to “CHO/DLY” or “REV,” and press [ENTER].

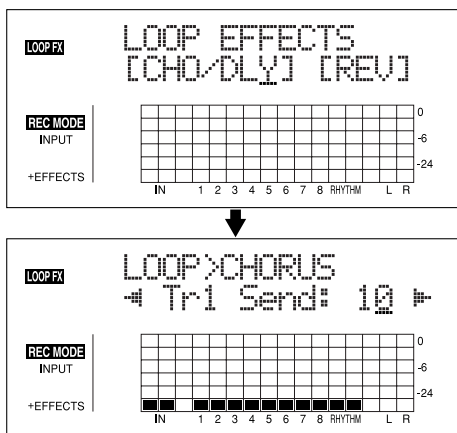

3. Press CURSOR [◀] [▶] until “FX Type” or “Type” is displayed, then turn the TIME/VALUE dial to select the loop effect.

When using CHO/DLY

Select from “CHORUS,” “DELAY,” or “DBLN” (doubling).

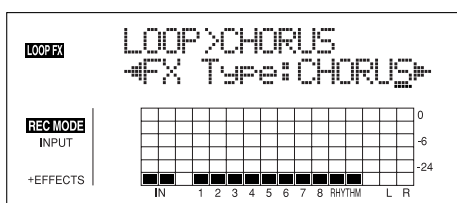

When using REV

Select either “HALL” or “ROOM.”

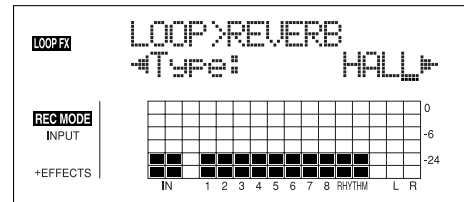

4. To change the settings for the selected effect, press CURSOR [◀] [▶] to select the parameter and turn the TIME/VALUE dial to change the set value.

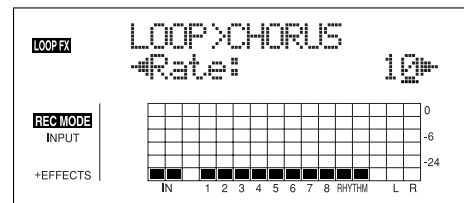

For a description of the parameters for each effect, refer to “Loop Effect Parameter Functions” (p. 111).

5. When you finish making settings, press [EXIT] repeatedly to return to the PLAY screen.

Doubling

When you want to spread out the guitar backing sound to the left and right, record the same guitar backing separately to two tracks, then pan the sounds to the left and right. This is known as “doubling.”

By using the “DBLN” loop effect, you can produce a doubling effect even from a single-track (mono) recording, allowing you to make more efficient use of the tracks.

* If you want to emphasize the doubling effect, pan the track completely to the right or to the left and increase the doubling effect level. In addition, use the following procedure to raise the send level.

Adjusting How the Loop Effect is Applied

The following explains how you can alter the volume of the signals sent by each track to the loop effects (the send level), and control the degree to which the loop effects are applied.

1. Press [LOOP EFFECTS].
2. Press CURSOR [◀] [▶] to move the cursor to “CHO/DLY” or “REV,” and press [ENTER].

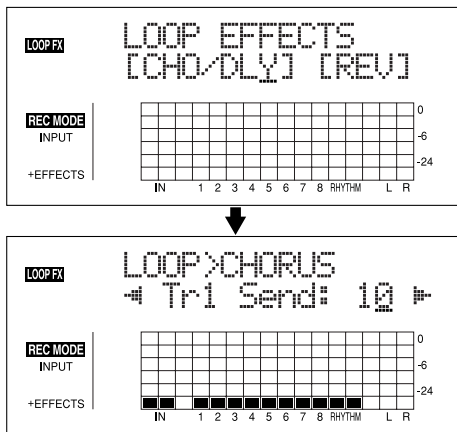

3. Press CURSOR [◀] [▶] to select the screen for setting the send level of each track appears.

When using CHO/DLY

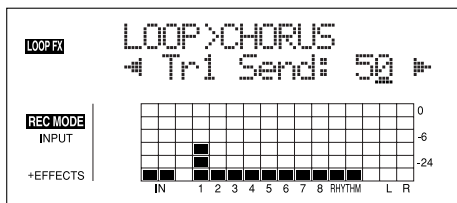

When using REV

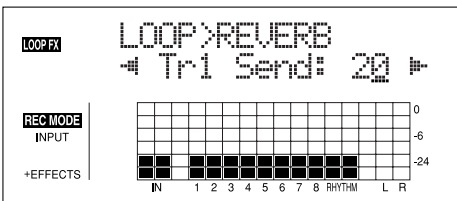

4. Use [CURSOR] and the TIME/VALUE dial to adjust the send level for each track.

* Pressing a REC TRACK button moves the cursor to the track corresponding to the button pressed.

If you then press CURSOR [◀], the screen for setting the input-source send level appears in the display; if you press CURSOR [▶], the one for setting the Rhythm send level is displayed.

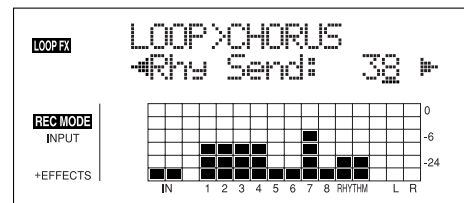
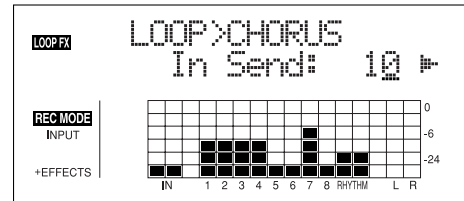

To adjust the send level for the input source, move the cursor to “In Send.” To adjust the send level for the Rhythm, move the cursor to “Rhy Send.” The setting is adjusted by turning the TIME/VALUE dial to the desired value.

5. After you have completed adjusting the send level, press [EXIT] repeatedly to return to the Play screen

MEMO

You can switch screens in the following sequence, with the screen cycling to the next screen each time [LOOP EFFECTS] is pressed.

Loop Effects selection screen → Send Level screen → Type screen → Play screen

Setting the Track EQ

This section explains how to edit the Track EQ settings (parameters).



For a fuller description of Track EQ, refer to “Track EQ Parameter Functions” (p. 112).



Track EQ do not have “patches.” Loop effect settings are saved along with the song data.

If you want to save the settings in the currently selected song, hold down [STOP], and press [REC].

1. Press [PAN/EQ].
2. Press CURSOR [◀] [▶] to move the cursor to “EQ,” and press [ENTER].

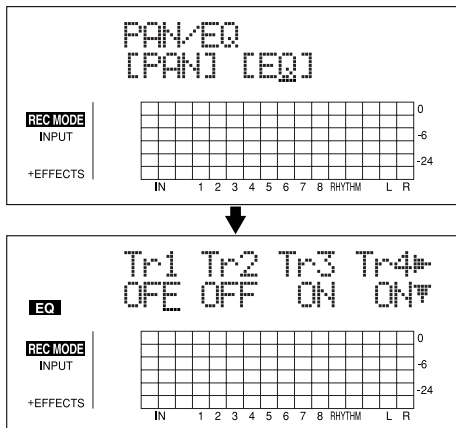

3. Use CURSOR [◀] [▶] and the TIME/VALUE dial to set the EQ On/Off for each track.

* Pressing a REC TRACK button moves the cursor to the track corresponding to the button pressed.

4. To change the EQ settings, press CURSOR [▽] repeatedly to display the parameter screen, then turn the TIME/VALUE dial to change the settings value.

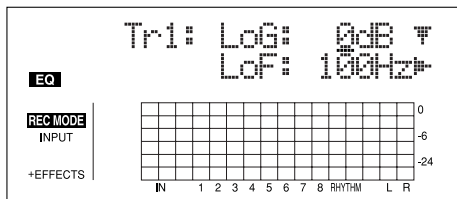

5. After you have completed the setting, press [EXIT] repeatedly to return to the Play screen

Loop Effect Parameter Functions

Parameter List

CHORUS/DELAY/DBLN (Doubling)

This selects the chorus, delay, or doubling effect.

FX Type

This sets the type of the effect.

CHORUS:

A sound with a subtly shifted pitch is added to the direct sound, making the final output sound thicker and broader.

DELAY:

This creates a thicker sound by applying a delayed sound to the direct sound.

DBLN:

By adding a slightly time-delayed sound to the direct sound, this produces the impression that multiple sources are sounding together (a “doubling” effect). The delayed sound will be output from the side opposite to which the playback track has been panned.

■ When “CHORUS” is selected

Rate 0–100

Adjusts the rate of the Chorus effect.

Depth 0–100

Adjusts the depth of the Chorus effect.

Pre Dly 0.5–50.0 ms

Adjusts the time needed for the effect sound to be output after the direct sound has been output.

E.Level 0–100

Adjusts the volume of the effect sound.

■ When “DELAY” is selected

Dly Tme 10–1000 ms

This parameter adjusts the delay time (i.e., the interval for which sound is delayed).

Feedback 0–100

This parameter adjusts the amount of feedback. Changing the amount of feedback causes the number of times the delayed sound is repeated to change as well.

E.Level 0–100

This adjusts the volume of the delay sound.

Rev Send 0–100

Adjust the volume of the reverb that is applied to the delayed sound.

■ When “DBLN” is selected

Dly Tme 0.5–50.0 ms

This parameter adjusts the delay time (i.e., the interval for which sound is delayed).

E.Level 0–100

This adjusts the volume of the delay sound.

REVERB

Reverberation (or reverb) is the effect caused by sound waves decaying in an acoustic space, or a digital simulation thereof. This decay occurs because sound waves bounce off many walls, ceilings, objects, etc. in a very complex way. These reflections, coupled with absorption by various objects, dissipate the acoustic energy over a certain period of time (called the decay time). The ear perceives this phenomenon as a continuous wash of sound.

Type

This selects the Reverb Type.

ROOM:

Simulates the reverberation in a small room.

HALL:

Simulates the reverberation in a concert hall.

Rev Time 0.1–10.0

This parameter adjusts the duration (time) of the reverb.

Tone -12– +12

Adjusts the tone.

E.Level 0–100

This adjusts the volume of the reverb sound.

Track EQ Parameter Functions

Parameter List

This is a two-band equalizer that is independent for each track.

NOTE

If you adjust the equalizer while listening to the sound, you may notice a clicking noise. This is not a malfunction. If the noise is objectionable, make adjustments while the sound is not playing.

On/Off **OFF, ON**

This parameter turns the equalizer effect on/off.

LoG **-12– +12 dB**

This sets the gain (-12 to +12 dB) for the low-range equalizer (shelving type).

LoF **40 Hz–1.5 kHz**

This sets the center frequency (40Hz to 1.5 kHz) for the low-range equalizer (shelving type).

HiG **-12 – +12 dB**

This sets the gain (-12 to +12 dB) for the high-range equalizer (shelving type).

HiF **500 Hz–18 kHz**

This sets the center frequency (500 Hz to 18 kHz) for the high-range equalizer (shelving type).

Fixing the Pitch of Vocals (Pitch Correction)

The Pitch Correction

The term Pitch Correction is used to describe a group of effects that are used on recorded vocal tracks to fix incorrect pitches. When compared with guitars, pianos, and other musical instruments, the human voice generally produces a relatively unstable tone. And when recording unprepared vocalists, this can often lead to considerable difficulties in the form of notes sung out of tune and poor sound quality.

When properly used, the BR-900CD's Pitch Correction will help to ensure that your vocal tracks will always sound great.

Makeup of the Pitch Correction

This effect is intended for use with the playback of recorded audio tracks and cannot be used on input sources.

The Pitch Correction and audio tracks are connected as shown below.

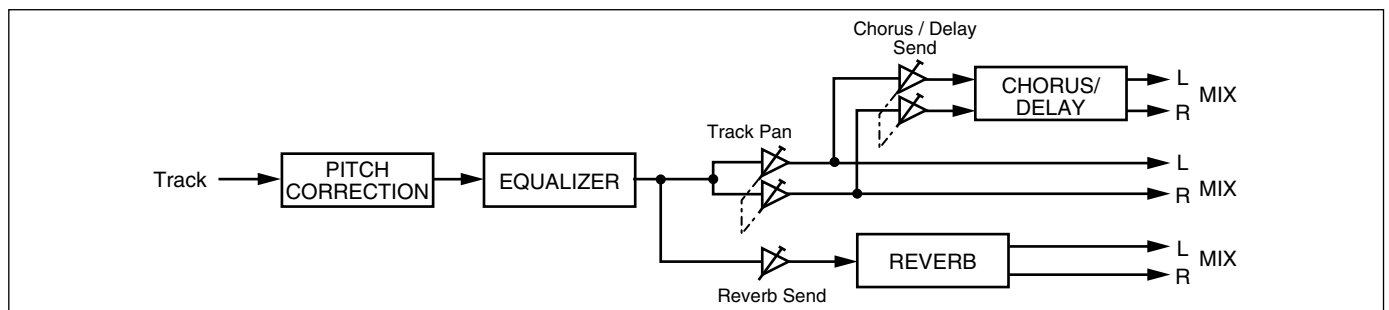

Pitch Correction Patches

In the case of pitch correction, you can set up the way in which the effect is to be applied and can then save these settings. A group of such settings is referred to as a Patch.

At the time of purchase, a total of 5 pitch correction patches (i.e., preset patches) will be stored in the BR-900CD. In addition, 5 song patches can be set up for use within a specific song.

Precautions for Pitch Correction Usage

- When you are using the Pitch Correction, you will not be able to use insert effects, or the Mastering Tool Kit.
- The Pitch Correction is intended for use with recorded vocal tracks and it cannot be applied to input sources or the Master output.
- These effects will function when applied to solo performances other than vocals; however, the fundamental differences between the character of the human voice and that of musical instruments makes it highly unlikely that the desired result will be achieved.
- In the following situations, the Pitch Correction may not be able to accurately detect the pitch, and normal operation will not be possible.
 - When other sounds are mixed in with the solo vocal part.
 - When the volume of the vocal part is excessively loud or quiet.
 - When the vocal part contains a lot of sibilance or is very breathy (such as a singer that whispers, or one with a husky voice).
 - When the vocal part contains an excessive number of different pitches (such as fast, deep vibrato or fast speech)
 - When the part is sung with a very low voice containing a lot of harmonics.
- * *If the BR-900CD is frequently incorrect when detecting the pitch, either change the "Type" setting for the pitch correction function. In certain cases, this will reduce the number of incorrect detections.*

Using the Pitch Correction

Let's now use the BR-900CD's pitch correction feature to clean up some mistakes in a solo vocal part.

Using this feature, we will be able to correct pitches in real time and in semitone units.

1. Before using pitch correction, record a solo vocal track to work with.

2. Press [REC MODE] several times until the BOUNCE indicator lights up.

The BR-900CD will now enter Bounce mode.

3. Press [PITCH CORRECTION].

This button will light up to indicate that the Pitch Correction is turned on.

The Pitch Correction patch selection screen will appear.

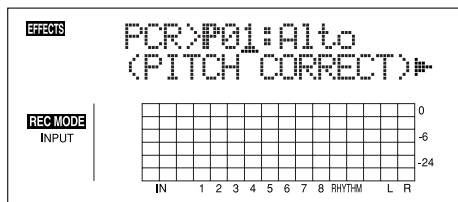

4. Press CURSOR [\triangleleft] [\triangleright] to move the cursor to "LOCAT," and press [ENTER].

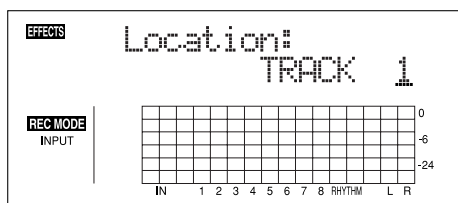

5. Use TIME/VALUE dial to select the track containing the solo vocal recording.

The following tracks can be selected at this time:
Tracks 1 through 6, Tracks 7/8

6. Start playback on the BR-900CD.

Pitches will be corrected in the solo vocal part as it is played. Listen to the part to confirm that it is now completely in tune, and if necessary, adjust the volume of the part using the corresponding track fader.

Press [STOP] to end playback.

7. Press [EXIT] to return to the patch selection screen.

8. Use [CURSOR] to move the cursor to the patch number and select a patch using the TIME/VALUE dial.



"Pitch Correction Patch List" (p. 205)

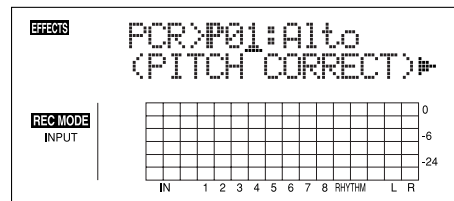

9. Press [EXIT].

10. Use [CURSOR] and the TIME/VALUE dial to select the track or V-track to which the edited result is to be recorded.

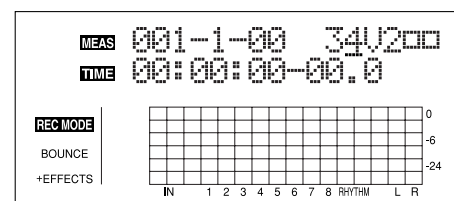

The button for the selected track flashes in red, indicating that the track has been selected as the REC track.

11. Move the faders for all tracks except the track containing the solo vocal recording all the way down.

Note that this also applies to the Rhythm fader.

12. Press [ZERO] to jump to the start of the song and then press [REC].

[REC] will turn red and start to flash, indicating that the BR-900CD is now ready for recording.

13. Press [PLAY].

Both [PLAY] and [REC] will light up and recording will start. The solo part will be played and any incorrect pitches will be fixed. At the same time, the corrected part will be recorded on the selected track.

14. Press [STOP] at the point where you want to stop recording.

The BR-900CD will stop playback.

15. Press [ZERO] to jump to the start of the song once again and then start playback of the recorded track.

Move the fader for the track containing the original vocal part all the way down, and raise the fader for the track containing the corrected vocal part to an appropriate point. As you listen to the corrected part, confirm whether or not you are happy with the corrections.



If you do not like the way the vocal part was corrected, use Undo (p. 57) to cancel the recording.

Setting the Correction Method for Vocal Pitch (Pitch Correction Edit)

Each of the preset patches 1 through 5 uses a slightly different method for correcting pitches. Normally, it will be sufficient to select the patch that gives the results you like best; however, if you cannot achieve favorable results using any of these patches, you can change the Pitch Correction settings to create a patch of your own.

1. Select a preset patch to base your new patch on.
2. Press CURSOR [◀] [▶] to move the cursor to “EDIT,” and press [ENTER].
The Pitch Correction edit screen will appear.
3. Use [CURSOR] to move the cursor to the setting you want to change and select a new value using the TIME/VALUE dial.

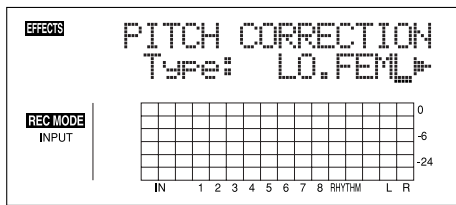

Type LO.MALE, HI.MALE, LO.FEML, HI.FEML

Set this parameter to match the type of voice in the original vocal part. If this parameter is not set correctly, problems will be more likely to occur in pitch detection and correction.

LO.MALE (Low Male)

Select this setting for a low-pitched, male voice.

HI.MALE (High Male)

Select this setting for a high-pitched, male voice.

LO.FEML (Low Female)

Select this setting for a low-pitched, female voice.

HI.FEML (High Female)

Select this setting for a high-pitched, female voice.

- * If the BR-900CD is frequently incorrect when detecting the pitch, either change the type setting. In certain cases, this will reduce the number of incorrect detections.

Smooth

0-100

This setting determines how quickly pitch correction will react to changes of pitch in the original vocal part. Large values result in a longer time before correction is applied; consequently, changes in pitch will be more gradual. Small values produce rapid changes in pitch.

Corrections that are made too rapidly seem robotic.

However, if the correction is too smooth, in some cases it may appear as if no correction has been applied. For natural sounding pitch corrections, set the value in a range between 20 and 40.

4. Press [EXIT].

The Pitch Correction’s patch selection screen will appear.

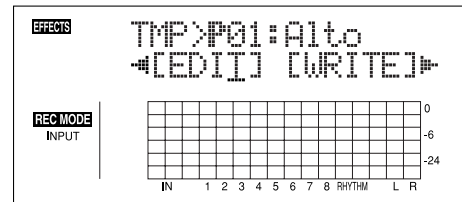

5. To save your modified settings, carry out the procedure described in “Saving the Pitch Correction Settings (Write)” below.

Saving the Pitch Correction Settings (Write)

Modified Pitch Correction settings are saved by writing them together under a new patch name.

- * You cannot write patches while songs are being recorded or played back.
- * If you do not need to change patch name, go to step 4.

1. At the Pitch Correction patch selection screen, press CURSOR [▶] to move the cursor to “NAME,” and press [ENTER].

The Patch Name Setting screen appears.

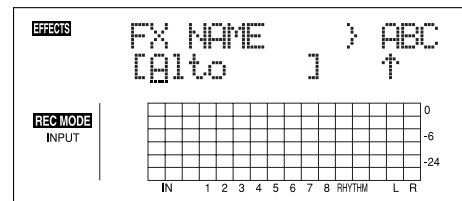

2. Use CURSOR [◀] [▶] and the TIME/VALUE dial to enter the patch name.
* Press [ENTER] to switch between uppercase and lowercase.
3. After you have completed entering the effect settings and patch name as desired, press [EXIT] to return to the Patch selection screen.
4. Press CURSOR [◀] [▶] to move the cursor to “WRITE,” and press [ENTER].

The Write screen appears.

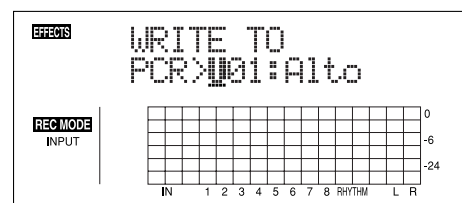

Fixing the Pitch of Vocals (Pitch Correction)

5. Turn the TIME/VALUE dial to select the patch number to which to write the new patch.

6. After you've selected the destination, press [ENTER].
After the save has been completed, you are returned to the Pitch Correction patch selection screen.

* During updating, "Keep power on!" appears in the upper line of the display, while the lower line shows what is being processed.

Making Detailed Settings for Pitch Correction (Correction Event Map)

In the procedures described thus far, what has been explained is how to correct the overall pitch for the entire song, from start to finish, in semitone increments.

In actual practice, however, there may be situations where you want to correct only a certain section or adjust the pitch differently. In such instances, use the following procedure.

1. Start by switching to BOUNCE mode and selecting the patch to which pitch correction is to be applied.
2. Use [CURSOR] to move the cursor to "P.MAP" in the Pitch Correction patch selection screen and press [ENTER].

The Correction Event Map screen appears.

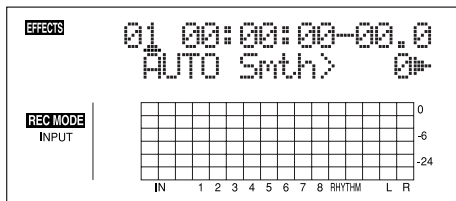

In the Correction Event Map screen, you can input the time at which you want the pitch correction to start as well as the pitch.

Taken together, this timing and pitch data is referred to as a "correction event."

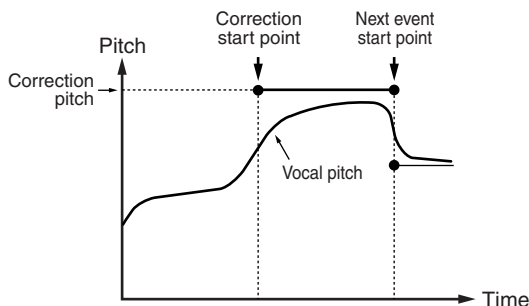

You can make corrections freely at the desired points in the song by arranging correction events in the sequence they occur.

The sequence of correction events with the information they contain is called a "correction event map."

Initially, only one correction event, "AUTO," is input at the beginning of the correction event map.

AUTO:

After the specified point in the song, all pitches are corrected in semitone increments.

3. Use [CURSOR] to move the cursor to "INSERT" and press [ENTER].

A new correction event is inserted.

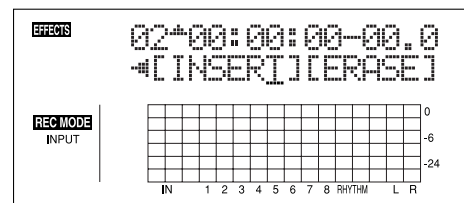

4. Use [CURSOR] to move the cursor to "Time" and specify the time at which you want the correction to start with the TIME/VALUE dial.

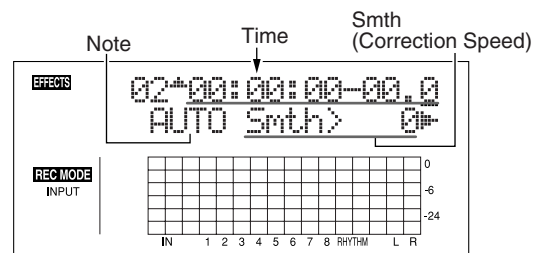

NOTE

You cannot change the time of the correction event at the start of the song.

5. Use [CURSOR] to move the cursor to "Note" and specify the pitch you want to correct with the TIME/VALUE dial.

Note:

OFF

No correction is made after the specified point in the song. The song is played using the original pitch.

AUTO

After the specified point in the song, all pitches are corrected in semitone increments.

C, C#, -A#, B

The performance after the specified point in the song is adjusted to the specified pitch.

MEMO

The reference pitch for NOTE is determined by the tuner's reference pitch. See "Setting the Reference Pitch of the Tuner" (p. 189).

6. Use [CURSOR] to move the cursor to “Smth” and specify the correction speed.

Smth (Smooth) -100-+100

The value set here is added to the value for the “Smooth” patch parameter (p. 115).

When set to 0, the correction proceeds at the rate set in the patch’s “Smooth” parameter.

The correction is performed more rapidly the lower the value is compared to the value set for the patch, while the correction is carried out more smoothly as the value increases relative to the patch’s value.

NOTE

Make this setting so that the sum is in the range from 0 to 100. No effect is achieved if the resulting value is lower than 0 or greater than 100.

7. Use [CURSOR] to move the cursor to “INSERT” and press [ENTER].

Another new correction event is inserted.

8. Use [CURSOR] to move the cursor to “TIME” and specify the time at which you want the correction to end with the TIME/VALUE dial.

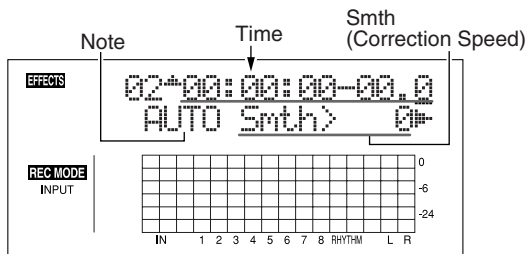

9. Use [CURSOR] to move the cursor to “NOTE” and specify “OFF.”

10. Have the Recorder play the song from the beginning.

The correction is first applied at the point in the song specified in Step 4, with the correction ending at the point specified in Step 8.

11. To delete any unnecessary correction events, move the cursor to the event and press [DELETE/MUTE].

The correction event is deleted.

NOTE

You cannot delete the correction event at the beginning of the song. If this correction event is unneeded, rather than deleting it, just set the function to “OFF.”

12. Repeat Steps 3–11 as needed to specify the edited range.

13. After you have completed entering the settings, press [EXIT] repeatedly to return to the Play screen.

NOTE

You can only save a Correction Event Map to a single song. Even if you switch the patch with the pitch correction, the Correction Event Map remains unchanged.

MEMO

Section 4

Using the

Rhythm

Using the Rhythm

The “Rhythm” is a dedicated Rhythm track that can not only play back Rhythm sounds as a guide during recording, you can also use it to play internal Rhythm patterns and original user-created Rhythm patterns and to play and record these patterns as your own Rhythm part performances.

The Rhythm features two modes, “Pattern mode” and “Arrangement mode.”

Pattern Mode

You can perform patterns and create your own original patterns.

Arrangement Mode

You can perform arrangements and create your own original arrangements.

About the Patterns

These are phrases consisting of from one to several measures of drum performance.

Types of patterns

Preset patterns (P001–P327)

These are internal patterns stored in the BR-900CD that have already been prepared for use. There are 327 patterns categorized by musical genre, such as “rock” and “jazz.”

* You cannot change and overwrite Preset pattern data.

Preset patterns include prepared patterns for intros, verses, fill-ins, and endings (you can confirm the type by looking at the characters at the end of the pattern name).

(Example)

ROCK1-IN (Intro)	ROCK1-V2 (Verse2)
ROCK1-V1 (Verse 1)	ROCK1-F2 (Fill 2)
ROCK1-F1 (Fill 1)	ROCK1-E (Ending)



“Preset Pattern List” (p. 207)

IN (Intro)

Music patterns to be placed at the beginning of a song.

V (Verse) 1 and 2

Music patterns to make up the main part of the song. “1” are basic patterns and “2” are more advanced versions of “1.”

F (Fill) 1 and 2

Music patterns to be used as phrases to connect different sections of a song. You can select either “1” or “2” depending on the form that will follow the fill.

E (Ending)

Music patterns to be placed at the ending of a song.

Song patterns (S001–S100)

These are patterns whose data is rewritable, and up to 100 different patterns for each song can be stored on memory cards.



About the Arrangements

Arrangements are sequences of patterns arranged in the order they are performed and with the tempo set.

Intro Tempo: 120.0	Verse Tempo: 110.0	Fill Tempo: 130.0	...
-----------------------	-----------------------	----------------------	-----

Types of arrangements

Preset arrangements (P01–P50)

These are internal arrangements stored in the BR-900CD that have already been prepared for use. There are 50 patterns categorized by musical genre, such as “rock” and “jazz.”

* You cannot change and overwrite Preset arrangement data.

In each Preset arrangement (except for Metro 4/4), a BREAK (rest) of three measures is played after the END (ending), and then the V1 (verse 1) is played repeatedly.



“Preset Arrangement List” (p. 206)

Song arrangements (S01–S05)

These are arrangements whose data is rewritable, and up to 5 different arrangements for each song can be stored on memory cards.

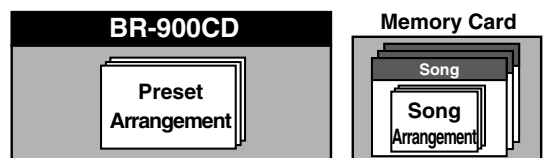

Switching the Rhythm Mode

The Rhythm mode switches each time [ARRANGE/PATTERN/OFF] is pressed.

[ARRANGE/PATTERN/OFF]: Lit (Arrangement Mode)

Performance and programming of arrangements is enabled. Press [PLAY] to start the performance of the arrangement.

* You cannot play back or record during programming.

[ARRANGE/PATTREN/OFF]: Flashing (Pattern Mode)

Performance and programming of patterns is enabled. Press [PLAY] to start the performance of the pattern.

* You cannot play back or record during programming.

[ARRANGE/PATTERN/OFF]: Unlit (OFF)

The Rhythm does not play.

Recording Rhythm Performances

When you want to record Rhythm performances, be sure to record (bounce) in Bounce mode.

You can have only the Rhythm performance be recorded by bringing down all of the faders except the Rhythm fader.

For instructions on bounce recording, refer to "Putting Multiple Tracks Together (Bounce)" (p. 58).

Performing Arrangements and Patterns

Selecting arrangements

This procedure selects the arrangement to be played with the Rhythm.

1. Press [ARRANGE/PATTERN/OFF] repeatedly until the indicator is lit.

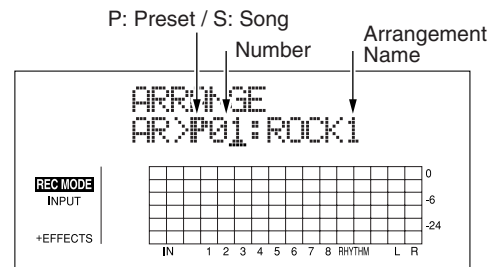

2. Select the arrangement.

Use CURSOR [◀] [▶] and the TIME/VALUE dial to select the Preset/Song and number.

P01–P50: Preset arrangements 1–50

S01–S05: Song arrangements 1–5

3. Press [EXIT] to return to the Play screen.

Performing arrangements

1. Make sure performance of the song is stopped, then press [ARRANGE/PATTERN/OFF] repeatedly until the indicator is lit.

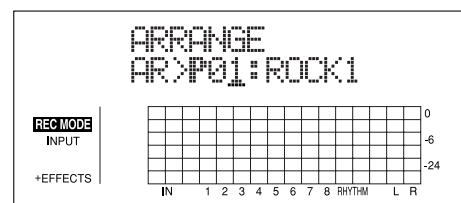

2. Select an arrangement.

Use CURSOR [◀] [▶] and the TIME/VALUE dial to select the Preset/Song and number.

3. Move the RHYTHM fader to the positions shown in the figure below.



4. Press [ZERO] to reset the play position back to the beginning of the arrangement, then press [PLAY].

The selected arrangement is performed.

Selecting patterns

This selects the pattern to be played with the Rhythm.

1. Press [ARRANGE/PATTERN/OFF] repeatedly until the indicator is flashing.

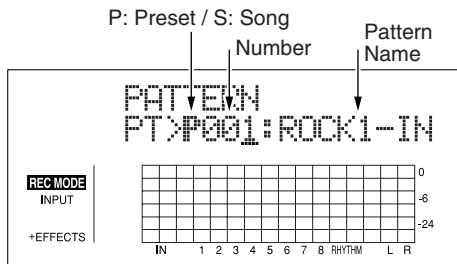

2. Select a pattern.

Use CURSOR [◀][▶] and the TIME/VALUE dial to select the Preset/Song and number.

P001–P327: Preset patterns 1–327

S001–S100: Song patterns 1–100

3. Press [EXIT] to return to the Play screen.

Performing patterns

1. Make sure performance of the song is stopped, then press [ARRANGE/PATTERN/OFF] repeatedly until the indicator is flashing.

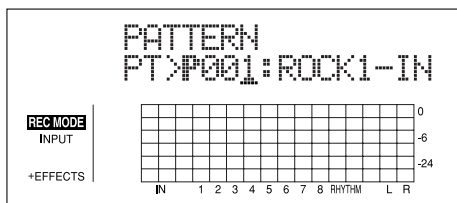

2. Select a pattern.

Use CURSOR [◀][▶] and the TIME/VALUE dial to select the Preset/Song and number.

3. Move the RHYTHM fader to the positions shown in the figure below.



4. Press [PLAY].

The selected pattern is performed.

No sound plays if "BREAK" is selected for the pattern.

Changing the tempo of the arrangements or patterns

You can temporarily change the tempo of the arrangement or pattern being played by carrying out the following procedure while the Play screen is displayed.

* The arrangement's tempo setting is temporarily disabled.

1. Press [CURSOR] and align the cursor up with "TEMPO" in the display.

2. Turn the TIME/VALUE dial to adjust the tempo.

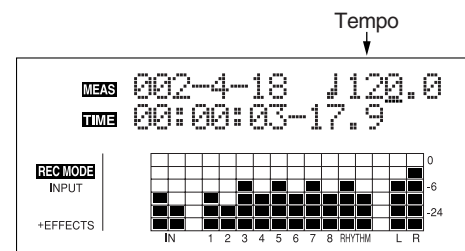

* The change in tempo is only temporary. If you want to change the arrangement's actual tempo, refer to p. 123.

* Tempos cannot be saved to patterns.

Tapping to change the tempo of the arrangements or patterns

You can temporarily change the tempo of the arrangement or pattern by the timing with which you press [TAP].

Tap on [TAP] four or more times to change the tempo of the arrangement or pattern. The tempo becomes that in which you tapped.



* The change in tempo is only temporary. If you want to change the arrangement's actual tempo, refer to p. 123.

* Tempos cannot be saved to patterns.

Creating Original Arrangements

You can create arrangements (Song arrangements) of up to 999 measures.

1. Make sure performance of the song is stopped, then press [ARRANGE/PATTERN/OFF] repeatedly until the indicator is lit.

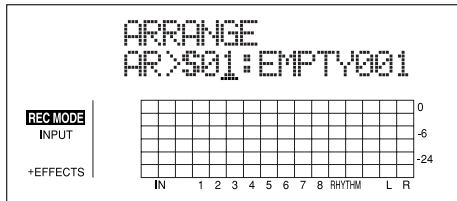

2. Press CURSOR [◀] [▶] and the TIME/VALUE dial to select the Arrangement number.

3. Press [EDIT].

The Arrangement Edit screen appears.

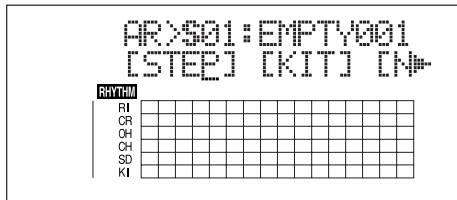

4. Press [CURSOR] to move the cursor to "STEP," and press [ENTER].

The Recording Standby screen appears.

- * You cannot switch from the Recording Standby screen for arrangements to other screens (except for the drum kit selection screen).

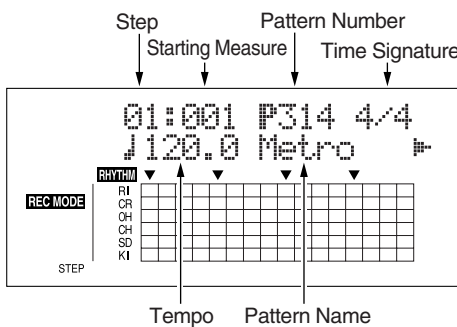

Information about the performance is displayed in the matrix display at the bottom of the screen.

5. Press [CURSOR] to move the cursor to "Step," then turn the TIME/VALUE dial to select the step to be edited.

- * You can press [REW] to move to the immediately preceding step, or press [FF] to move to the next step.

6. Press [CURSOR] to move the cursor to the parameter you want to change, then turn the TIME/VALUE dial to change the setting's value.

- * You can press [PLAY] here to play the sound of the pattern in the currently selected step.

Starting Measure

Set the measure where the pattern that is selected by the current step will start playing.

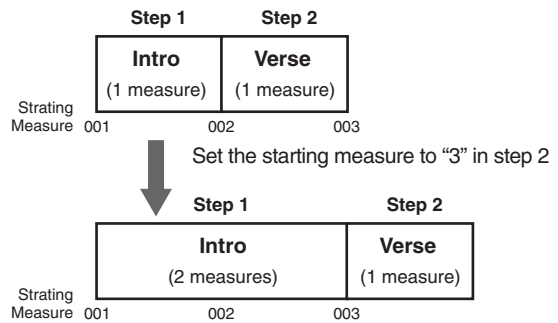

- * The starting measure for step 1 is always set to "001." This cannot be changed.
- * You cannot set a starting measure that is equal to, or earlier than the starting measure that is set for the previous step.
- * You cannot set a starting measure that is beyond the starting measure of the next step.

Pattern Number

Select the pattern. Set the patterns for each step as shown in the figure below.

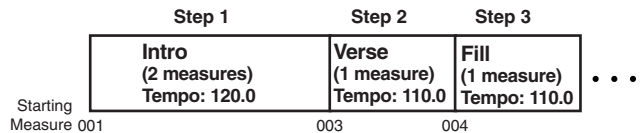

- * When an arrangement is played from within the Play screen, the arrangement plays all the way to the end, and then the performance of the pattern set in the last step is repeated. Thus, by setting the preset pattern "P327 BREAK" for the last step, you can have a rest be played repeatedly, which makes it seem as if the performance of the arrangement has stopped.



Time Signature

Set the time signature of the pattern that is selected by the current step.

Tempo

Set the tempo of the pattern that is selected by the current step.

Valid Settings: 25.0–250.0

7. When you have finished creating the arrangement, press [EXIT] repeatedly.

The Play screen is displayed again, and the arrangement is saved.

- * During updating, "Keep power on!" appears in the upper line of the display, while the lower line shows what is being processed.

Inserting a Step

Perform the procedure below to insert a new step into the location of the present step.

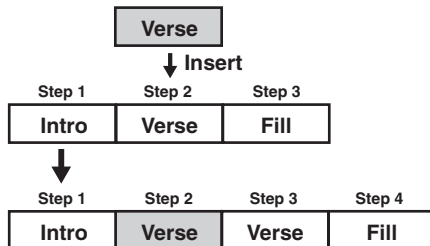

* The parameter value of inserted step will be the same as of the targeted step.

1. Make sure performance of the song is stopped, then press [ARRANGE/PATTERN/OFF] repeatedly until the indicator is lit.
2. Press [EDIT].
The Arrangement Edit screen appears.
3. Press [CURSOR] to move the cursor to "STEP," and press [ENTER].
The Recording Standby screen appears.
4. Use [CURSOR] and the TIME/VALUE dial to set the location (step) where the data is to be inserted.

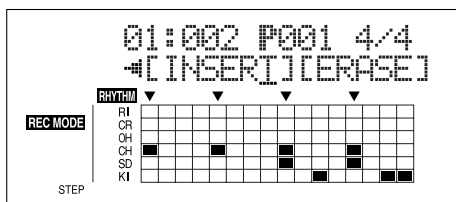

5. Press CURSOR [>] repeatedly to move the cursor to "INSERT" and press [ENTER].

To cancel the operation, press CURSOR [<] to return to the Arrangement Edit screen.

When you press [ENTER], the display indicate "Insert!" then return to the Recording Standby screen.

Erasing a Step

This erases the content of the currently selected step. The content of the following steps are brought forward to fill the erased step.

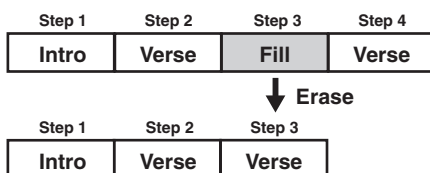

* No further data can be deleted when only Step 1 remains.

1. Make sure performance of the song is stopped, then press [ARRANGE/PATTERN/OFF] repeatedly until the indicator is lit.
2. Press [EDIT].
The Arrangement Edit screen appears.
3. Press [CURSOR] to move the cursor to "STEP," and press [ENTER].
The Recording Standby screen appears.
4. Use [CURSOR] and the TIME/VALUE dial to set the step to be erased.

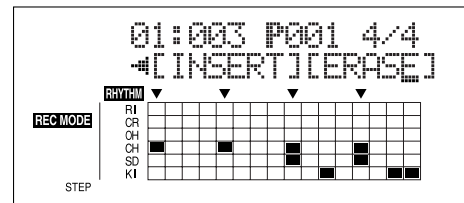

5. Press CURSOR [>] repeatedly to move the cursor to "ERASE" and press [ENTER].

To cancel the operation, press CURSOR [<] repeatedly to return to the Arrangement Edit screen.

When you press [ENTER], the display indicate "Erase!" then return to the Recording Standby screen.

Naming Arrangements

You can edit the name of the currently selected arrangement.

* You can use up to eight characters in naming arrangements.

1. Press [ARRANGE/PATTERN/OFF] repeatedly until the indicator is lit.
2. Press [EDIT].
3. Press CURSOR [>] repeatedly to move the cursor to "NAME," and press [ENTER].

The Change Arrangement Name screen appears.

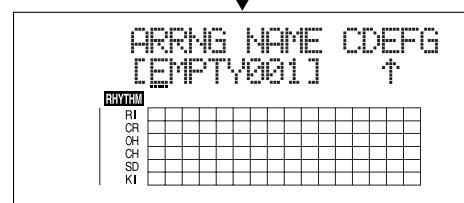
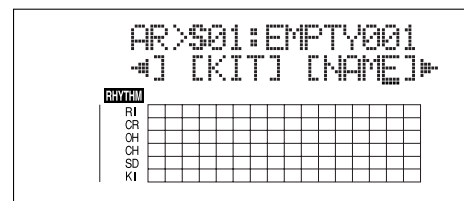

* You cannot change Preset arrangement names.

- Press **CURSOR** [\triangleleft] [\triangleright] and turn the **TIME/VALUE** dial to change the characters.

* Press **[ENTER]** to switch between uppercase and lowercase.

- Press **[EXIT]** repeatedly to return to the Play screen.

* During updating, "Keep power on!" appears in the upper line of the display, while the lower line shows what is being processed.

Copying Arrangements

You can take the currently selected arrangement and copy it to another Song arrangement.

- Press **[ARRANGE/PATTERN/OFF]** repeatedly until the indicator is lit.

- Press **[EDIT]**.

The Arrangement Edit screen appears.

- Press **[CURSOR]** to move the cursor to "COPY," and press **[ENTER]**.

The screen for selecting the copy destination is displayed.

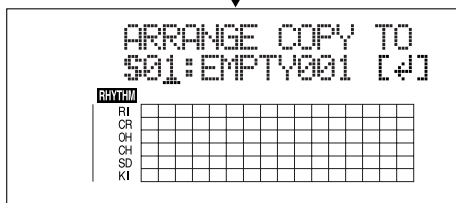
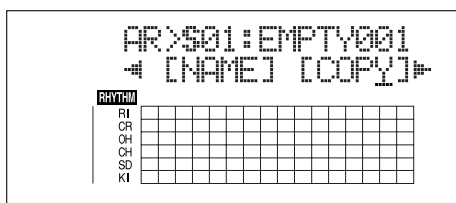

- Turn the **TIME/VALUE** dial to select the copy-destination arrangement.

S01–S05: Song arrangements 1–5

- Once you have decided on the copy destination, press **[ENTER]**.

The screen for confirming the copy destination appears.

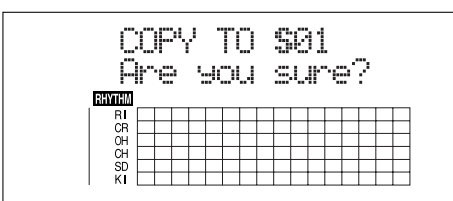

- Press **[ENTER]** (YES) to copy.

To cancel, press **[EXIT]** (NO).

- Press **[EXIT]** repeatedly to return to the Play screen.

* During updating, "Keep power on!" appears in the upper line of the display, while the lower line shows what is being processed.

Erasing Arrangements

This erases Step 2 and all subsequent steps in the arrangement currently being selected.

* "Metro" (the metronome) is set in Step 1.

- Press **[ARRANGE/PATTERN/OFF]** repeatedly until the indicator is lit.

- Press **[EDIT]**.

The Arrangement Edit screen appears.

- Press **[CURSOR]** to move the cursor to "ERASE," and press **[ENTER]**.

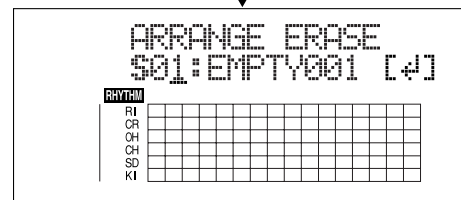
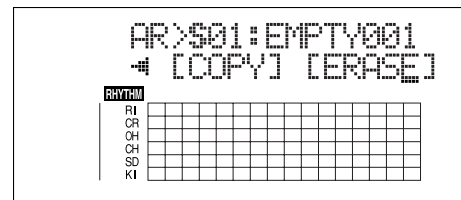

- Turn the **TIME/VALUE** dial to select the arrangement to be erased.

S01–S05: Song arrangements 1–5

- If you want to erase the arrangement, press **[ENTER]**.

The screen for confirming the deletion appears.

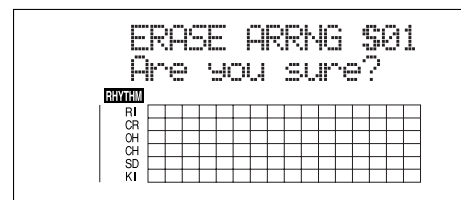

- Press **[ENTER]** (YES) to erase the arrangement.

To cancel, press **[EXIT]** (NO).

- Press **[EXIT]** repeatedly to return to the Play screen.

* During updating, "Keep power on!" appears in the upper line of the display, while the lower line shows what is being processed.

Creating Original Patterns

When creating a Rhythm arrangement by stringing together Rhythm patterns, there may be times when you do not find anything suitable among the preset Rhythm patterns, or when you want to get a Rhythm pattern that sounds exactly the way you want. In such cases, you can create your own original Rhythm patterns.

There are three ways to create Rhythm patterns.

Realtime Recording

In Realtime Recording, you record while tapping the TRACK buttons in time with the metronome. Rhythm patterns are played back repeatedly, and the data being input is mixed in with these sounds. Additionally, even if your timing is a little off when tapping the buttons, you can use the Quantize function to rectify the input so the timing is correct.

Step Recording

In Step Recording, the timing of sounds and the drum sounds are programmed one at a time. There are two ways to input drum sounds:

- Specifying the timing of a sound (measure-beat-click), and inputting the drum sound at that point by tapping the TRACK button.
- Inputting a drum sound at the desired timing within the detailed framework dividing a single measure (the matrix). This allows you to visually get an overall grasp of the Rhythm pattern, making for a simple way to create Rhythm patterns.

Importing SMFs

You can import SMFs (Standard MIDI Files) as song patterns. For instructions on this procedure, refer to p. 169 or p. 179.

Note concerning creation of patterns

- Maximum polyphony for patterns is five voices. This means you can play up to five drum sounds with the same timing.
- Even if six or more drum sounds are input at the same time, only five of the drum sounds will be sounded. However, the "■" signifying the entry in the matrix display remains as is.
- You cannot play the CLOSED HH and OPEN HH sounds at the same time. However, the "■" signifying the entry in the matrix display remains as is.
- When using cymbals and other sounds that have lengthy decay times, if other sounds totalling five voices are input before the previous sound has completely vanished, Sounds started previously may be cut off before they finish playing.
- You cannot switch to other screens while recording patterns (except for the pattern record standby screen).

Creating Patterns in Realtime Recording

1. Press [ARRANGE/PATTERN/OFF] repeatedly until the indicator is flashing.

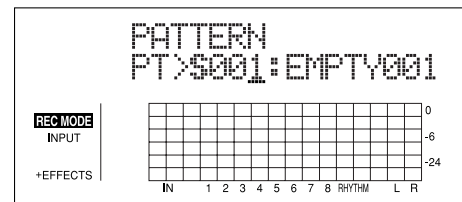

2. Press [EDIT].

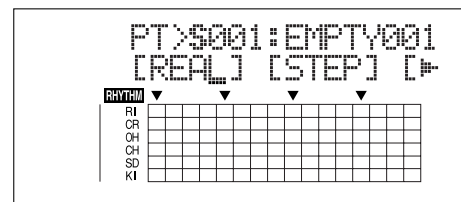

3. Press [CURSOR] to move the cursor to "REAL," and press [ENTER].

"REAL" appears in REC MODE at the left of the screen. The Recording Standby screen appears.

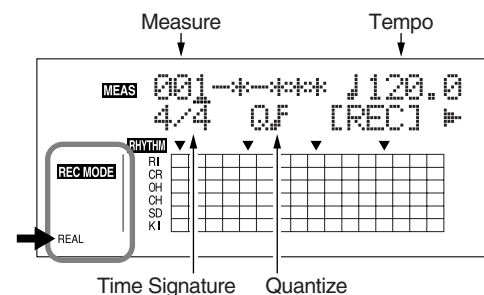

- Use [CURSOR] and the TIME/VALUE dial to set the measure, beat, and click from which to start recording of the pattern.

Measure

This sets the number of measures in the pattern to be recorded.

Valid Settings: 1–999

Tempo

When recording, this sets the tempo for confirming the pattern.

Valid Settings: 25.0–250.0

- * The tempo setting here is exclusively for confirmation of the pattern recording. This tempo is not stored in the pattern (you cannot make any individual tempo settings for the patterns themselves).

Time Signature

This sets the time signature (i.e., the beat) for the pattern to be recorded.

Valid Settings: 1/1–8/1, 1/2–8/2, 1/4–8/4, 1/8–8/8

Quantize

This sets the recording quantization.

Setting Quantize lets you to have the sounds being input conform to preset note lengths, thus eliminating discrepancies in the input timing.

- * Press “HI” you want to keep the timing used to input the sounds.

Valid Settings:

♪ Quarter note	♪ ₃ Sixteenth-note triplet
♪ ₃ Quarter-note triplet	♪ Thirty-second note
♪ Eighth note	♪ ₃ Thirty-second-note triplet
♪ ₃ Eighth-note triplet	HI
♪ Sixteenth note	

- Press CURSOR [◀] [▶] to move the cursor to “REC,” and press [ENTER].

The count-in is played, and then Realtime Recording starts.

- * You can also start Realtime Recording by pressing the [REC] button.

- Set the velocity (how “hard” the note is played) for the sounds to be input from the current point by adjusting Fader 1.

The current velocity value is briefly indicated where the beat value normally appears.

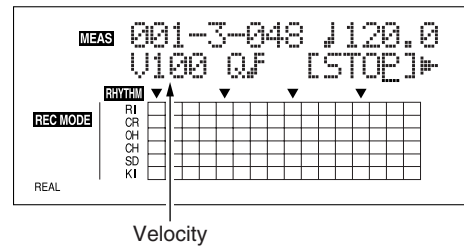

- Input the drum sounds with the desired timing.

Use REC TRACK [1]–[6] to input the drum sounds.

You can switch the UPPER and LOWER drum sounds by pressing [RHYTHM PAD].

[RHYTHM PAD] Lit

Enables input of the UPPER drum sounds.

REC TRACK [1]	KICK
REC TRACK [2]	SNARE
REC TRACK [3]	CLOSED HIHAT
REC TRACK [4]	OPEN HIHAT
REC TRACK [5]	CRASH CYMBAL
REC TRACK [6]	RIDE CYMBAL

[RHYTHM PAD] Flashing

Enables input of the LOWER drum sounds.

REC TRACK [1]	CROSS STICK
REC TRACK [2]	COWBELL
REC TRACK [3]	TOM1
REC TRACK [4]	TOM2
REC TRACK [5]	TOM3
REC TRACK [6]	TOM4

You can confirm the drum sound currently being input by checking the matrix at the bottom part of the display.

Indicated in the matrix

You can confirm the timing at which each rhythm instrument sounds in the matrix display.

The ▼ mark in the lower part of the matrix indicates beat timing.

Creating Original Patterns

* When a coarse Quantize setting is used, the ▼ mark may indicate half-note or quarter-note timing.

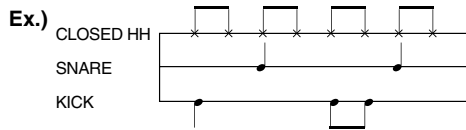

• Q (Quantize) = 1/2



• Q (Quantize) = 1/4

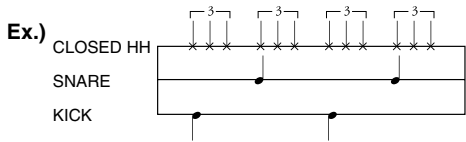
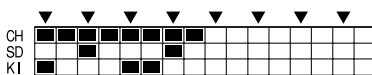

• Q (Quantize) = 1/8

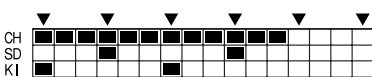

When using high-resolution Quantize settings, you may be unable to view the entire pattern, from start to finish, in the display at one time.

In such instances, a "▶" symbol appears, indicating that there is material not currently displayed.

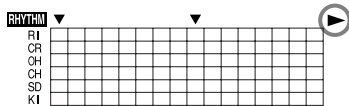

HINT

You can press [REC MODE] during Realtime Recording to switch to Step Recording.

Using this option allows you to switch to Step Recording temporarily when you want to change the set velocity or input drum sounds input with the wrong timing in Realtime Recording (instructions for this procedure: p. 132), or to delete unneeded drum sounds (instructions: p. 132), and then switch back to Realtime Recording and continue recording the pattern.

8. Set the tempo and Quantize values as needed.
9. When you have finished inputting sounds, move the cursor to "STOP" and press [ENTER].

* You can also stop recording by pressing [STOP].

Rehearsing recordings

You can practice (rehearse) your performances along with the metronome before carrying out Realtime Recording. During rehearsals, the drum sounds are only played, and are not recorded to the pattern even if you press the track buttons.

1. Press [ARRANGE/PATTERN/OFF] repeatedly until the indicator is flashing.

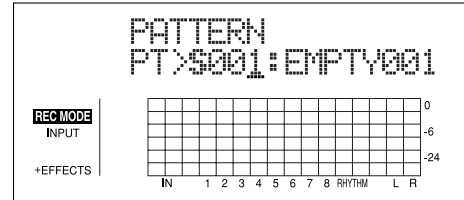

2. Press [EDIT].

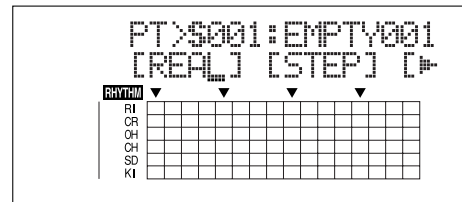

3. Press [CURSOR] to move the cursor to "REAL," and press [ENTER].

"REAL" appears in REC MODE at the left of the screen. The Recording Standby screen appears.

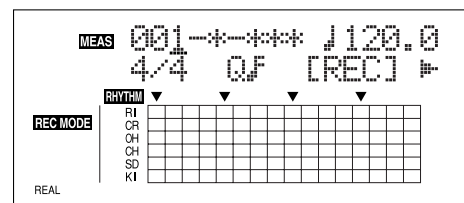

4. Press CURSOR [▷] repeatedly to move the cursor to "RHR," and press [ENTER].

The BR-900CD is put into Rehearsal mode.

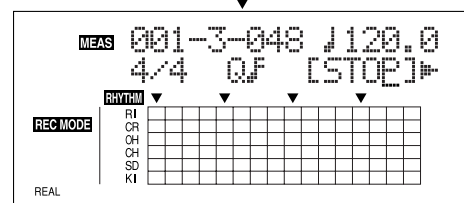
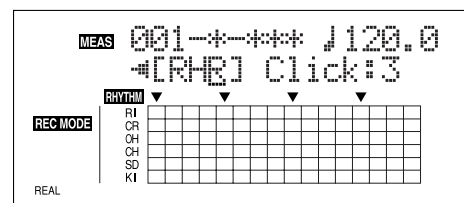

5. Rehearse the performance by pressing the REC TRACK [1]–[6].

You can switch the UPPER and LOWER drum sounds by pressing [RHYTHM PAD].

* At this point, adjust Fader 1 to confirm the velocity status.

6. When you have finished rehearsing, move the cursor to “STOP” and press [ENTER].

* You can also quit the rehearsal by pressing [STOP].

Deleting unneeded drum sounds

You can delete any drum sounds you do not need during Realtime Recording by holding down [DELETE/MUTE] and pressing the track buttons.

1. When you hold down [DELETE/MUTE] and press one or more REC TRACK buttons for the tones you want to delete.

The corresponding drum sounds are deleted for as long as the buttons are pressed.

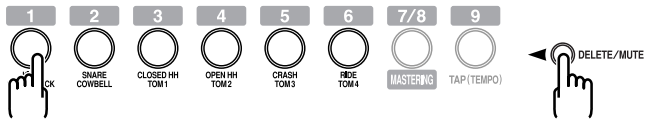

Changing the metronome volume

1. Press [ARRANGE/PATTERN/OFF] repeatedly until the indicator is flashing.

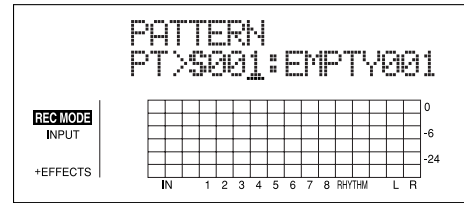

2. Press [EDIT].

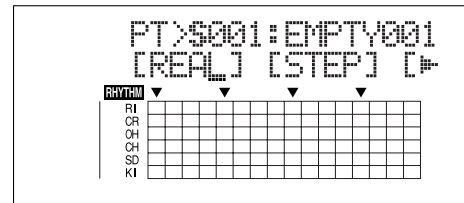

3. Press [CURSOR] to move the cursor to “REAL,” and press [ENTER].

“REAL” appears in REC MODE at the left of the screen.

The Recording Standby screen appears.

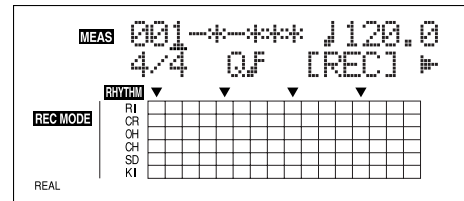

4. Press CURSOR [] repeatedly to move the cursor to “Click.”

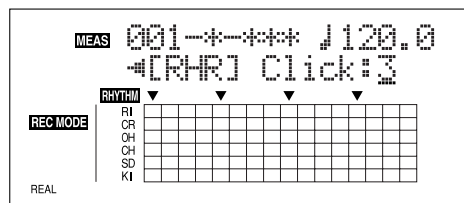

5. Turn the TIME/VALUE dial to adjust the metronome volume.

Valid Settings: 0–3

Creating Patterns in Step Recording

1. Press [ARRANGE/PATTERN/OFF] repeatedly until the indicator is flashing.

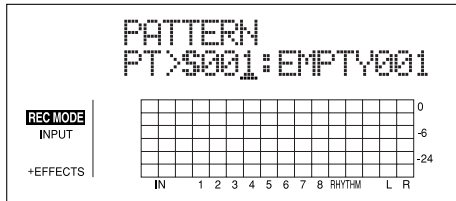

2. Press [EDIT].

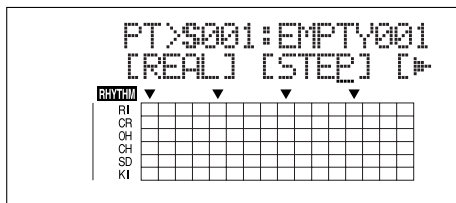

3. Press [CURSOR] to move the cursor to "STEP," and press [ENTER].

"STEP" appears in REC MODE at the left of the screen. The recording standby screen appears in the display.

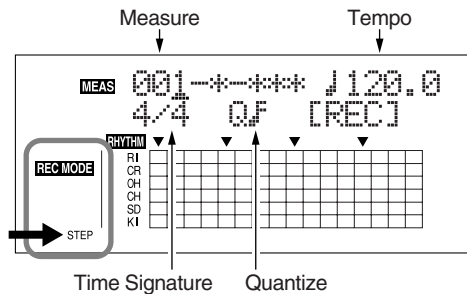

4. Use [CURSOR] and the TIME/VALUE dial to set the measure, beat, and quantize from which to start recording of the pattern.

Measure

This sets the number of measures in the pattern to be recorded.

Valid Settings: 1-999

Tempo

When recording, this sets the tempo for confirming the pattern.

Valid Settings: 25.0-250.0

- * The tempo setting here is exclusively for confirmation of the pattern recording. This tempo is not stored in the pattern (you cannot make any individual tempo settings for the patterns themselves).

Time Signature

This sets the time signature (i.e., the beat) for the pattern to be recorded.

Valid Settings: 1/1-8/1, 1/2-8/2, 1/4-8/4, 1/8-8/8

Quantize

This sets the resolution for the steps being input.

- ♪ Quarter note (96)
- ♪₃ Quarter-note triplet (64)
- ♪ Eighth note (48)
- ♪₃ Eighth-note triplet (32)
- ♪₃ Sixteenth-note triplet (16)
- ♪ Thirty-second note (12)
- ♪₃ Thirty-second-note triplet (8)
- HI (1)
- ♪ Sixteenth note (24)

Numerals in parentheses indicate the clock. The lower the value set, the finer the resolution each beat becomes.

(Ex.) ♪: Here you can input sounds in eighth-note lengths.

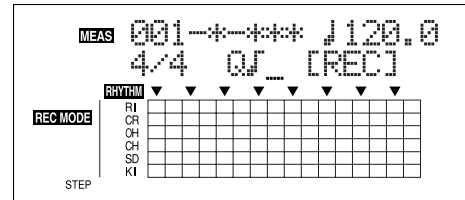

(Ex.) ♪: Here you can input sounds in sixteenth-note lengths.

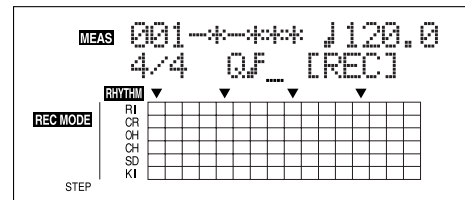

5. Press CURSOR [◀][▶] to move the cursor to "REC," and press [ENTER].

Step Recording starts.

- * You can also start recording by pressing [REC].

6. Press CURSOR [◀][▶] to move the cursor to the measure, beat, and clock, then turn the TIME/VALUE dial to specify the time at which the drum sound is to be input.

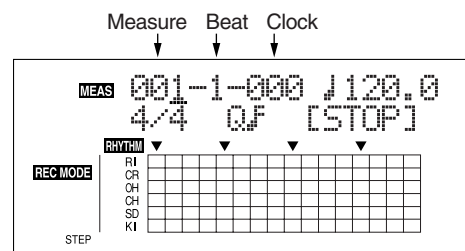

7. Set the velocity (how “hard” the note is played) for the sounds to be input from the current point by adjusting Fader 1.

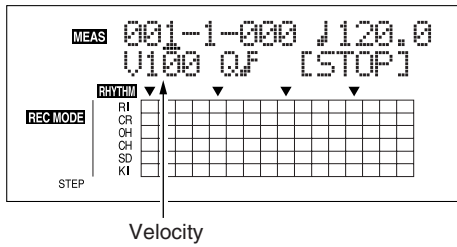

8. Input the drum sounds.

There are two ways to input drum sounds.

(Method 1) Inputting with the REC TRACK buttons

Use REC TRACK [1]–[6] to input the drum sounds.

You can switch the UPPER and LOWER drum sounds by pressing [RHYTHM PAD].

[RHYTHM PAD] Lit

Enables input of the UPPER drum sounds.

- REC TRACK [1] KICK
- REC TRACK [2] SNARE
- REC TRACK [3] CLOSED HIHAT
- REC TRACK [4] OPEN HIHAT
- REC TRACK [5] CRASH CYMBAL
- REC TRACK [6] RIDE CYMBAL

[RHYTHM PAD] Flashing

Enables input of the LOWER drum sounds.

- REC TRACK [1] CROSS STICK
- REC TRACK [2] COWBELL
- REC TRACK [3] TOM1
- REC TRACK [4] TOM2
- REC TRACK [5] TOM3
- REC TRACK [6] TOM4

(Method 2) Inputting with the [ENTER]

Press CURSOR [∇] to move the cursor to the matrix display.

Press [CURSOR] to move the cursor to the intersection of the drum sound you want to input and the time at which you want it to sound, then press [ENTER].

The drum sound is alternately input or deleted each time you press [ENTER].

“■” flashes rapidly when you move the cursor to a point where a sound has already been input. When a drum sound is input, the display changes to “■.”

Pressing CURSOR [\triangle] in the top row of the matrix display returns the cursor to its original position.

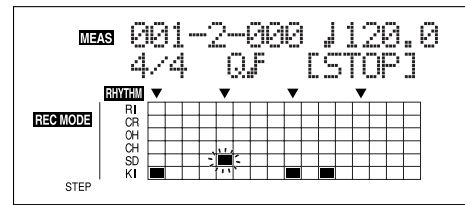

Indicated in the matrix

You can confirm the timing with which each rhythm instrument sounds in the matrix display.

The ▼ mark in the lower part of the matrix indicates beat timing.

- * When a coarse Quantize setting is used, the ▼ mark may indicate half-note or quarter-note timing.

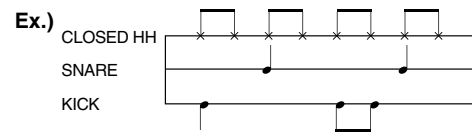

• Q (Quantize) = $\frac{1}{2}$

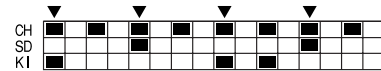

• Q (Quantize) = $\frac{1}{4}$

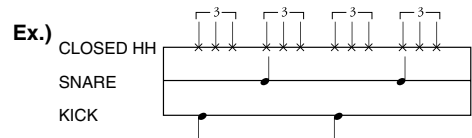
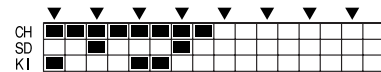

• Q (Quantize) = $\frac{1}{8}$

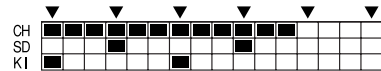

When using high-resolution Quantize settings, you may be unable to view the entire pattern, from start to finish, in the display at one time.

In such instances, a “▶” symbol appears, indicating that there is material not currently displayed.

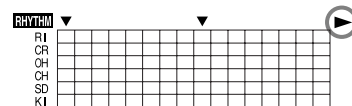

- * In this case, you can press [REW]/[FF] to move the location (cursor) in large steps.

HINT

You can press [REC MODE] during Step Recording to switch to Realtime Recording.

9. Set the tempo and Quantize values as needed.

10. Repeat Steps 6–9 as needed.

* Press [PLAY] to listen to the recording pattern.

11. When you have finished inputting sounds, move the cursor to "STOP" and press [ENTER].

* You can also stop recording by pressing [STOP].

Changing the velocity

During Step Recording, when you move the cursor to a point in the matrix display where a drum sound has been input, the velocity value appears in the position where the time signature is normally indicated. At this point, you can change the velocity by adjusting Fader 1.

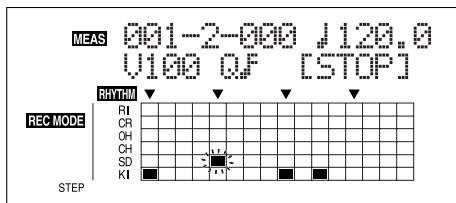

Deleting unneeded drum sounds

You can use either of the two following methods to delete unneeded drums sounds in Step Recording.

(Method 1)

1. Move the [CURSOR] to the point in the matrix display where a drum sound you want to delete has been input, then press [ENTER].

(Method 2)

1. When you hold down [DELETE/MUTE] and press one or more track buttons for the tones you want to delete.

You can delete the unneeded drum sound at the current measure, beat, and clock.

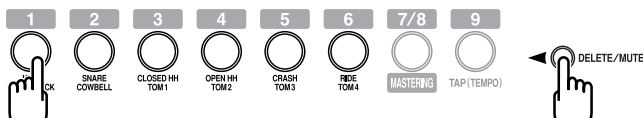

Naming Patterns

You can use up to eight characters in naming patterns.

* You can not change the Preset Pattern name.

1. Press [ARRANGE/PATTERN/OFF] repeatedly until the indicator is flashing.

2. Press [EDIT].

3. Press [CURSOR] to move the cursor to "NAME," and press [ENTER].

The Change Pattern Name screen appears.

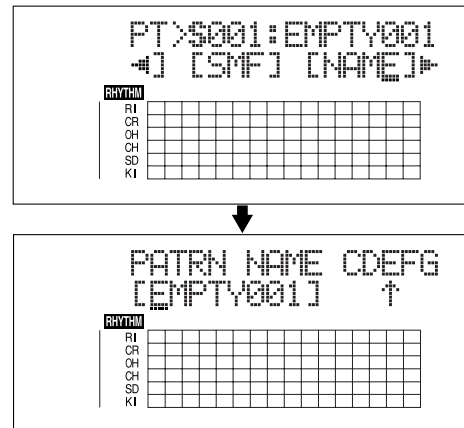

4. Press CURSOR [◀] [▶] and turn the TIME/VALUE dial to change the characters.

* Press [ENTER] to switch between uppercase and lowercase.

5. Press [EXIT] repeatedly to return to the Play screen.

* During updating, "Keep power on!" appears in the upper line of the display, while the lower line shows what is being processed.

Copying Patterns

1. Press [ARRANGE/PATTERN/OFF] repeatedly until the indicator is flashing.
2. Press [EDIT].
3. Press [CURSOR] to move the cursor to "COPY," and press [ENTER].

The Pattern Copy screen appears.

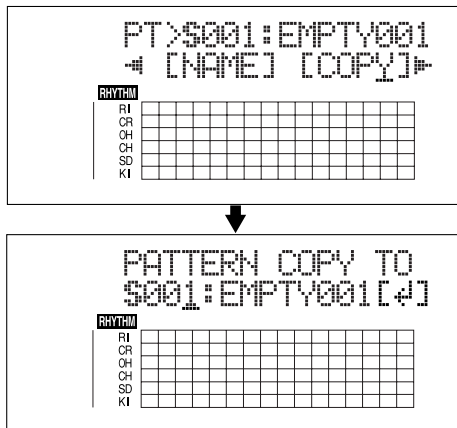

4. Turn the TIME/VALUE dial to select the copy-destination arrangement.
S001–S100: Song Pattern 1–100
5. Press [ENTER].

The screen for confirming the copy appears.

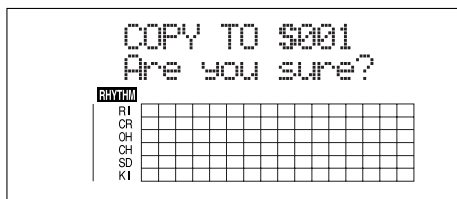

6. Press [ENTER] (YES) to copy.
To cancel, press [EXIT] (NO).
 7. Press [EXIT] repeatedly to return to the Play screen.
- * During updating, "Keep power on!" appears in the upper line of the display, while the lower line shows what is being processed.

Erasing Patterns

1. Press [ARRANGE/PATTERN/OFF] repeatedly until the indicator is flashing.
2. Press [EDIT].
3. Press CURSOR [▷] repeatedly to move the cursor to "ERASE," and press [ENTER].

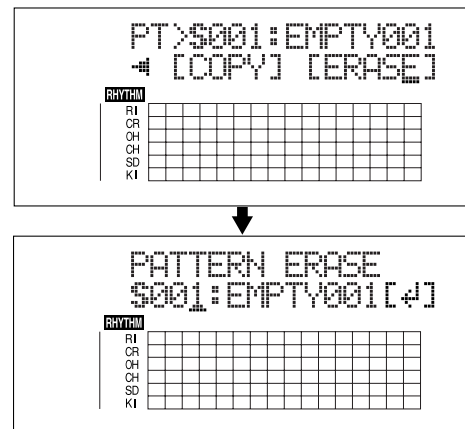

4. Turn the TIME/VALUE dial to select the pattern to be deleted.
S001–S100: Song Pattern 1–100
5. If you want to delete the pattern, press [ENTER].
The screen for confirming the deletion appears.

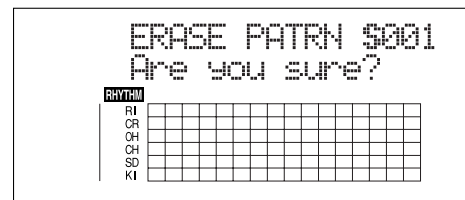

6. Press [ENTER] (YES) to delete the pattern.
To cancel, press [EXIT] (NO).
 7. Press [EXIT] repeatedly to return to the Play screen.
- * During updating, "Keep power on!" appears in the upper line of the display, while the lower line shows what is being processed.

Using the Drum Kits

A drum kit is a variety of rhythm instrument sounds collected in a single set; the BR-900CD includes nine internal “preset drum kits.”

In addition, you can also put together an additional five original “song drum kits.”

Song drum kits are saved to individual songs on memory cards.

The drum kit instrument sounds are used in the performance of the arrangements and patterns.

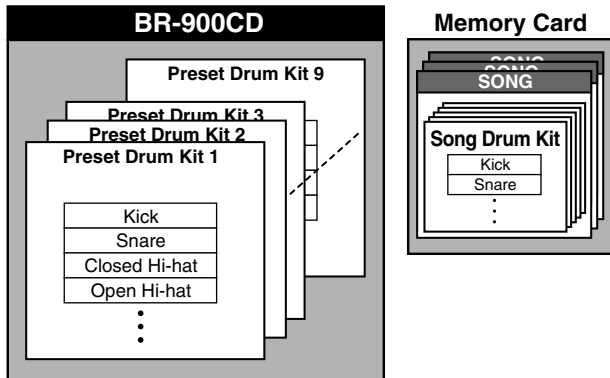

Performing the Drums

1. Make sure performance of the song is stopped, then press [RHYTHM PAD] repeatedly until the indicator is lit or flashing.
2. Press REC TRACK [1]–[6] to input the drum sounds.

[RHYTHM PAD] Lit

Enables performance of the UPPER drum sounds.

REC TRACK [1]	KICK
REC TRACK [2]	SNARE
REC TRACK [3]	CLOSED HIHAT
REC TRACK [4]	OPEN HIHAT
REC TRACK [5]	CRASH CYMBAL
REC TRACK [6]	RIDE CYMBAL

[RHYTHM PAD] Flashing

Enables input of the LOWER drum sounds.

REC TRACK [1]	CROSS STICK
REC TRACK [2]	COWBELL
REC TRACK [3]	TOM1
REC TRACK [4]	TOM2
REC TRACK [5]	TOM3
REC TRACK [6]	TOM4

Selecting Drum Kits

1. Make sure performance of the song is stopped, then press [ARRANGE/PATTERN/OFF] repeatedly until the indicator is lit.

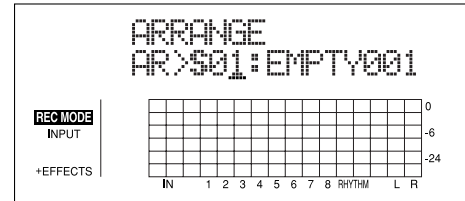

2. Press [EDIT].

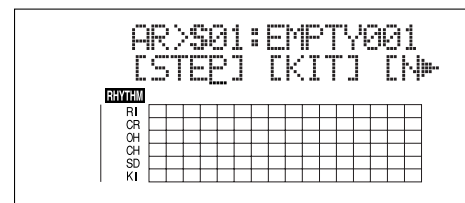

3. Press [CURSOR] to move the cursor to “KIT,” and press [ENTER].

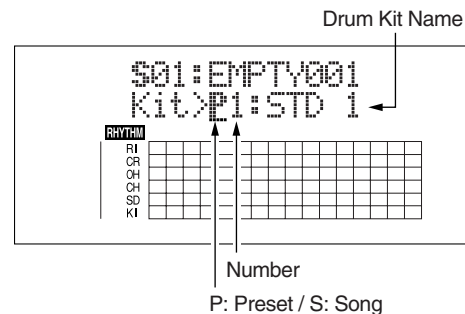

4. Use CURSOR [◀] [▶] and the TIME/VALUE dial to select drum kits by switching the preset/song and number.

(P1–9)	
STD1, 2:	Standard sets
ROOM:	Set with moderate ambience applied
HARD:	Set appropriate for hard rock
JAZZ:	Set appropriate for jazz
HIP-HOP:	Set appropriate for dance
HOUSE:	Set appropriate for dance
REGGAE:	Set appropriate for reggae
808:	Set based on the renowned “Roland TR-808” rhythm machine
(S1–5)	
SongKit1–5:	Original drum kits assigned to each song (p. 135).

5. Press [EXIT] repeatedly to return to the Play screen.

* *Drum kits are stored to each individual arrangement separately.*

(Example)

```
Arrangement   Drum Kit
ROCK 1.....ROOM
ROCK 2.....STD 2
:             :
```

Creating Original Drum Kits (Tone Load)

With the BR-900CD, you can create original drum kits not only with the internal drum sounds, but by loading drum sounds from external sources as well.

There are four ways to load drum tones.

- Loading from the tracks
- Loading from other drum kits
- Loading from WAV/AIFF files (p. 171, p. 181)
- Loading from WAV/AIFF files on CD-R/RW (p. 149)

NOTE

- The Rhythm and Tone Load functions cannot be used when tracks are bounced directly to a CD (p. 59).
- Wave data in the following formats can be imported. You cannot import wave data in other formats.
 - WAV or AIFF format
 - Mono or Stereo
 - 8-bit or 16-bit
 - Sampling Rate: 44.1 kHz
- Compressed WAV files or AIFF files cannot be loaded.
- Extremely short waveform data (less than approximately 100 msec) cannot be loaded.
- The loop point settings within an AIFF file will be ignored.
- Add the extension "WAV" to imported WAV files and the extension "AIF" to imported AIFF files.
- You can load drum sounds of up to 13 seconds for a single drum kit.

(Example)

Kick: 3 seconds, snare: 3 seconds,
crash cymbal: 7 seconds → Total 13 seconds

- Stereo WAV and AIFF files are loaded as "mono" sounds with the left and right sides mixed.

Loading from the tracks

This loads sounds recorded to the tracks as drum tones.

HINT

It can be convenient to use the "scrub," "punch in," and "locator" functions to set the range containing the drum sounds you want to load ahead of time.

You can use the scrub function to repeat playback and locate the point from which loading is to start (the start point) and press AUTO PUNCH [IN], then after determining the point at which loading is to finish (the end point), press [LOCATOR] to register the range to be loaded.

Using this technique of setting the start point with AUTO PUNCH [IN] and the end point with [LOCATOR] allows you to set the range to be loaded very rapidly.

1. Press [UTILITY].
2. Press CURSOR [◀] [▶] to move the cursor to "TONE," and press [ENTER].

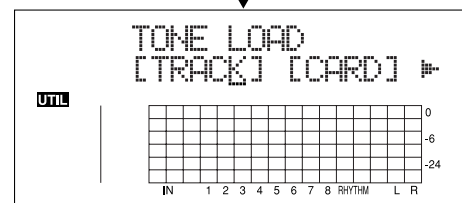
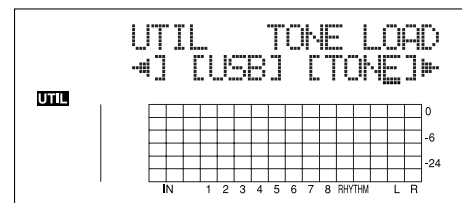

3. Press CURSOR [◀] to move the cursor to "TRACK," and press [ENTER].

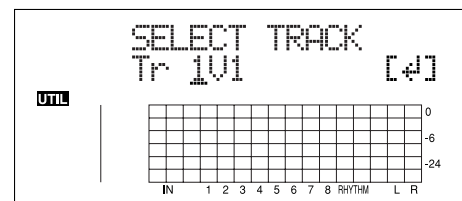

4. Use CURSOR [◀] [▶] and the TIME/VALUE dial to select the track and V-Track to which the drum sounds are to be loaded, then press [ENTER].

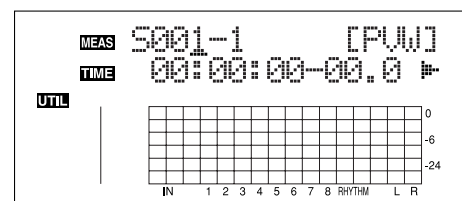

Using the Drum Kits

5. Use [CURSOR] and the TIME/VALUE dial to specify the range (start and end points) of drum sounds to be loaded in terms of measures or time locations.

- * You cannot specify an interval between the start and end points or a length of time in less than 100 ms or excess of 13 seconds.
- * When specifying measures, the result is reflected in the time display, and vice versa.

Start Point ("S")

Specify the measure or location to be used as the start point for loading the drum sounds.

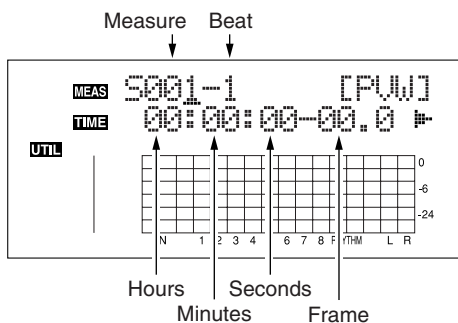

End Point ("E")

Specify the measure or location to be used as the end point for loading the drum sounds.

From the screen for setting the start point, press CURSOR [▷] repeatedly to display the screen for setting the end point.

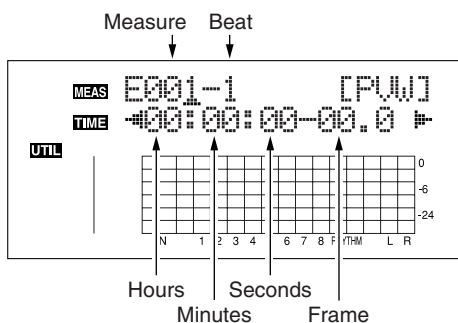

MEMO

- You can press [ENTER] to switch between the start point and end point settings screens.
- You can preview the drum sounds in the specified range by moving the cursor to "PVW" and pressing [ENTER]. Determine the sounds to load while setting the start and end points and the length, and repeating the preview. You can press [PLAY] to preview the sounds, and press [STOP] to stop the sounds.

6. When you have finished setting the start and end points, move the cursor to "LOAD" and press [ENTER].

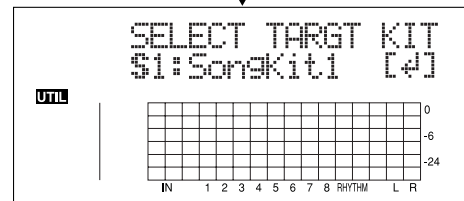
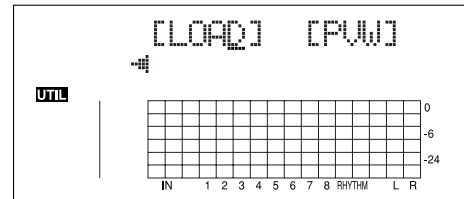

7. Specify the load-destination song drum kit with the TIME/VALUE dial, then press [ENTER].

S1-5: Song Drum Kit 1-5

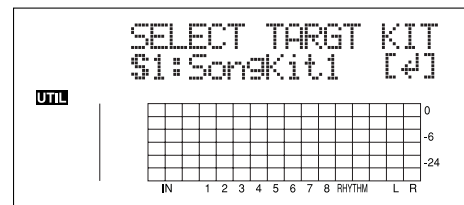

8. Specify the load-destination drum sound with the TIME/VALUE dial, then press [ENTER].

Loading is executed.

To cancel, press [EXIT].

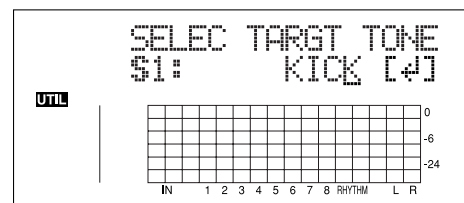

Copying drum sounds from other drum kits

- Press [UTILITY].
- Press CURSOR [◀] [▶] to move the cursor to "TONE," and press [ENTER].

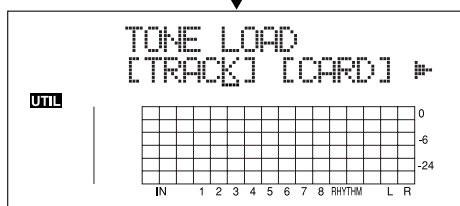
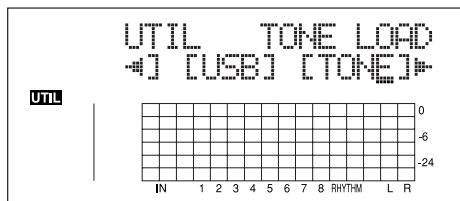

- Press CURSOR [◀] [▶] to move the cursor to "COPY," and press [ENTER].

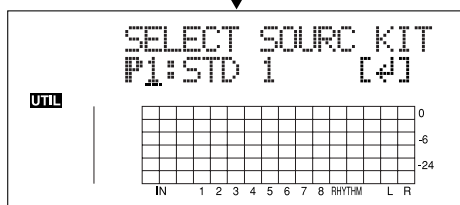
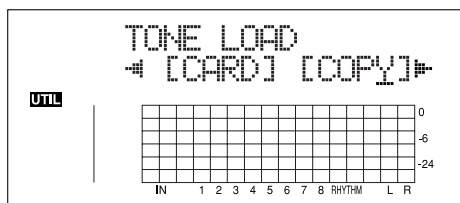

- Turn the TIME/VALUE dial to specify the copy-destination drum kit, then press [ENTER].

P1-9: Preset Drum Kit 1-9
S1-5: Song Drum Kit 1-5

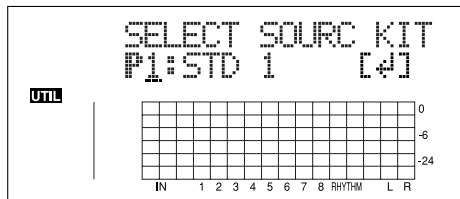

- Turn the TIME/VALUE dial to specify the copy-destination drum sound, then press [ENTER].
 - Select "ALL" if you want to copy all of the drum sounds in the kit.

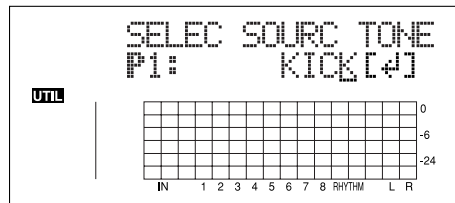

- Turn the TIME/VALUE dial to specify the copy-destination drum kit, then press [ENTER].

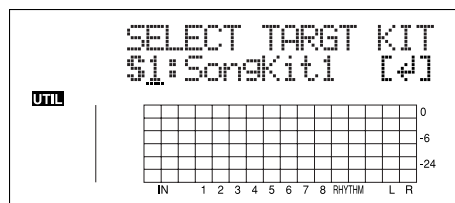

- Turn the TIME/VALUE dial to select the copy-destination song drum sound, then press [ENTER].
Copying is executed.

To cancel, press [EXIT].

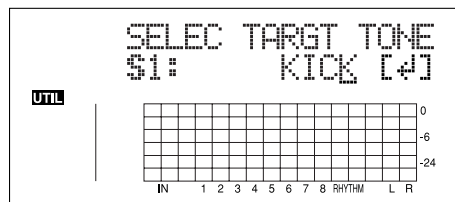

* During updating, "Keep power on!" appears in the upper line of the display, while the lower line shows what is being processed.

- Press [EXIT] to return to the Play screen.

Erasing drum sounds

1. Press [UTILITY].
2. Press CURSOR [◀] [▶] to move the cursor to "TONE," and press [ENTER].
3. Press CURSOR [◀] [▶] to move the cursor to "ERASE," and press [ENTER].

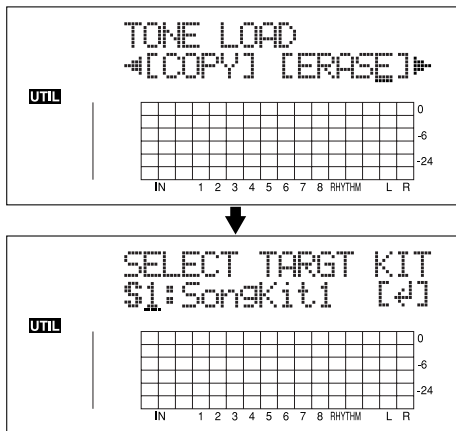

4. Turn the TIME/VALUE dial to specify the erase drum kit, then press [ENTER].

S1-5: Song Drum Kit 1-5

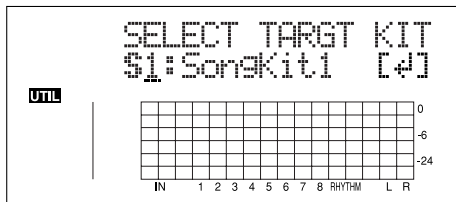

5. Turn the TIME/VALUE dial to specify the erase drum sound, then press [ENTER].

* Select "ALL" if you want to erase all of the drum sounds in the kit.

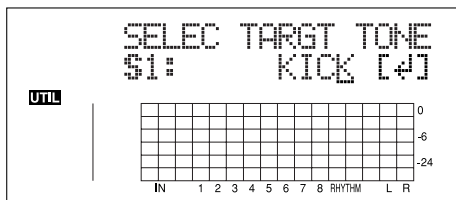

"Are you sure?" appears.

6. Press [ENTER] (YES) to erase the drum sound.
To cancel, press [EXIT] (NO).
7. Press [EXIT] to return to the Play screen.

Changing the position (pan) of the drum sounds

1. Press [UTILITY].
2. Press CURSOR [◀] [▶] to move the cursor to "TONE," and press [ENTER].
3. Press CURSOR [▶] to move the cursor to "PAN," and press [ENTER].

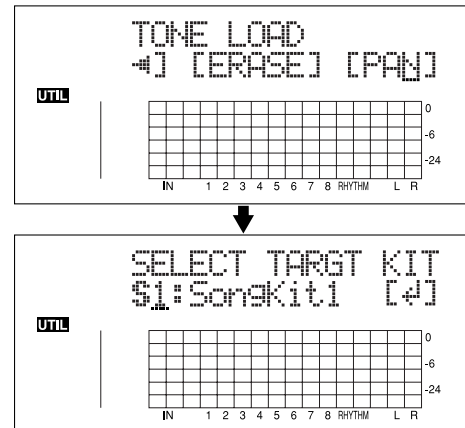

4. Turn the TIME/VALUE dial to specify the drum kit whose panning you want to change, then press [ENTER].

S1-5: Song Drum Kit 1-5

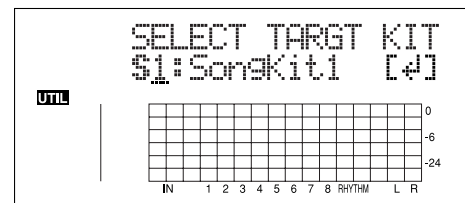

5. Use [CURSOR] and the TIME/VALUE dial to specify the drum sound whose panning is being changed and the pan setting.

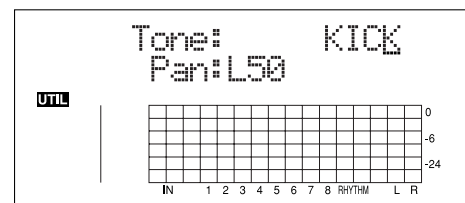

* When you press [RHYTHM PAD], causing the indicator to light/flash, you can then set the drum sounds by tapping REC TRACK [1]-[6].

* Pressing [ENTER] sets this to "C00" (Center).

6. Press [EXIT] to return to the Play screen.

Section 5

Using the CD-R/ RW Drive

Creating Audio CD

Precautions

In addition to CD-R discs, you can also use CD-RW discs when making audio CDs. However, it may not be possible for audio CDs created using CD-RW discs to be played on standard CD players.

Furthermore, even when CD-R discs are used for this purpose, playback will not be possible on CD players that do not support this type of media. You should, therefore, confirm that the CD player to be used is compatible with CD-R discs.

Note that the BR-900CD's CD-R/RW drive can play commercially produced audio CDs, CD-R discs, and CD-RW discs.

NOTE

When you use the CD-R/RW drive, you must use only the supplied AC adaptor. The CD-R/RW drive cannot be used while running on battery power.

Setting the Time Between Songs (Pre-Gap)

Often when you are playing audio CDs on standard CD players, you will see a countdown in the form of “-3, -2, -1” on the player's display before songs start. This duration is referred to as a Pre-Gap, and it can be freely set during the CD creation process to allow song lengths to be adjusted without having to record silence at the end of each.

1. Press [CD-R/RW].

The CD menu screen will appear.

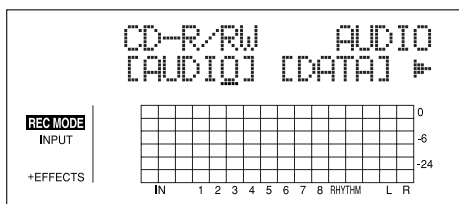

2. Press CURSOR [◀] [▶] to move the cursor to "AUDIO," and press [ENTER].

The Audio CD menu screen will appear.

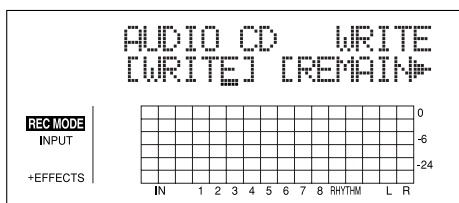

3. Press CURSOR [◀] [▶] to move the cursor to "GAP," and press [ENTER].

The pre-gap setting screen will appear.

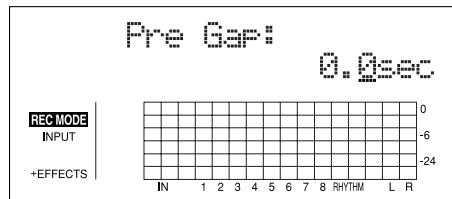

4. Use the TIME/VALUE dial to specify a gap time between songs in seconds.

5. Press [EXIT].

MEMO

If silence is included at the end of your finished song, the pre-gap time will be added to the length of this section, and as a result, the gap between songs will be longer than expected when the CD is played back on a CD player. For details regarding the deletion of silence from the end of songs, refer to “Erasing Data (Track Erase)” (p. 73).

Writing Songs to Discs

Have on hand the disc you want to burn as an audio CD.

You can write the data to any of the following discs.

- CD-R or CD-RW disc with no data written to it (blank disc)
- Discs that have song data that was written to them using the BR-900CD, but which still have space available for further recording and have not yet been finalized

MEMO

Methods for creating audio CDs

With the BR-900CD, only the currently loaded song is written to the audio CD. If you want to include other songs on your CD, they will each have to be loaded and written in sequence. When you use this method, individual songs can be added to a disc one at a time until it is full. This method is called “Track At Once.”

1. Load the song that you want to write.

2. Insert an unrecorded CD-R or CD-RW disc into the CD-R/RW drive.

3. Press [CD-R/RW].

The CD menu screen will appear.

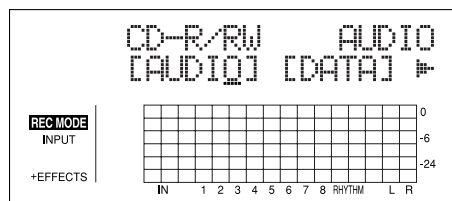

4. Press CURSOR [◀] [▶] to move the cursor to "AUDIO," and press [ENTER].

The Audio CD menu screen will appear.

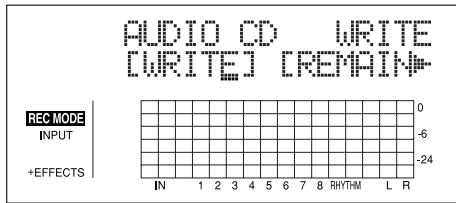

5. Press CURSOR [◀] [▶] to move the cursor to "WRITE," and press [ENTER].

The Audio CD Write screen will appear.

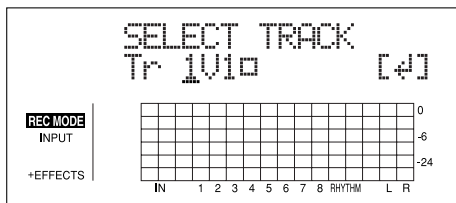

6. Use the TIME/VALUE dial to choose the track and V-Track that you want to write, and press [ENTER].

The Write Speed screen will appear.

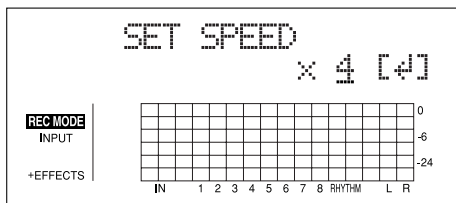

7. Use the TIME/VALUE dial to set the write speed. Alternatively, if you want to use the write speed that is currently displayed, proceed to Step 9.

8. Press [ENTER]. The message "Are you sure?" will appear.

9. Press [ENTER] (YES). The message "Now Writing..." will appear and writing to the audio CD will begin. When writing has been completed, the message "Finalize CD OK?" will be displayed.

10. If you intend to write additional songs to the same CD-R disc, press [EXIT] (NO). Alternatively, press [ENTER] (YES) if no more songs will be added to this disc.

If you press [ENTER] (YES), the message "Now Finalizing..." will appear and the finalization process will begin. When the message "Completed!" appears, it indicates that the finalization has been completed.

For more detailed information regarding finalization, refer to "What is finalization?"

11. Press [EXIT] several times to return to the Play screen.

12. Press the CD-R/RW drive's EJECT button to eject the disc.

This completes the writing process.

It may take a period of several seconds before the disc is actually ejected.

NOTE

- The range of available write speeds can sometimes be limited by the type of media being used. In such a case, the BR-900CD will allow you to select only the supported speeds.
- If you are using CD-R or CD-RW discs intended for high-speed writing, the frequency of write errors may increase if the x2 or x4 speed is selected. It is recommended that you use the x8 speed for high-speed discs.
- Note that selecting higher factor write speeds does not necessarily mean the speed will be that multiple exactly. This is due to the processing time required for conversion of the audio data on the audio tracks to CD format as the data is written to the disc.
- Audio CDs can be created with up to a maximum of 99 tracks on the disc.
- Audio CD standards require that one song be at least four seconds long. If a specified track lasts less than four seconds, the track cannot be written to the audio CD.

MEMO

What is finalization?

In addition to audio data, information such as the position and time of this data is also written to audio CDs, and this process is known as "Finalizing." If you intend to play your audio CD on a standard CD player, it is important that finalization be carried out. Once this has been done, however, you will not be able to add any more songs to the CD. For this reason, you should aim to carry out the finalization of a CD disc only when it is nearly full of songs.

If you don't finalize:

It will not be possible to play your audio CD on a standard CD player until it has been finalized; however, you can keep adding songs to the disc until this process is carried out. The CD-R disc that is not finalized during the writing process can be finalized later on. For more details regarding methods for finalization after the writing of audio data, refer to "Enabling Playback on CD Players (Finalize)" (p. 143).

Viewing the Remaining Time for Recording on Audio CDs

Use the following procedure to see how much time you have left for recording on an audio CD.

1. Insert a CD-R or CD-RW disc into the CD-R/RW drive.
2. Press [CD-R/RW].

The CD menu screen will appear.

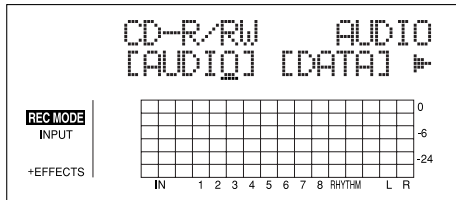

3. Press CURSOR [◀][▶] to move the cursor to "AUDIO," and press [ENTER].

The Audio CD menu screen will appear.

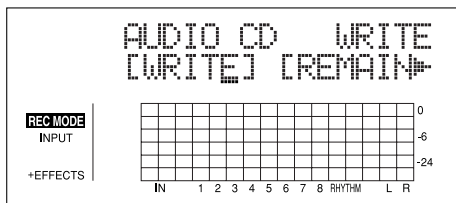

4. Press CURSOR [◀][▶] to move the cursor to "REMAIN," and press [ENTER].

The remaining time for recording on audio CD will appear.

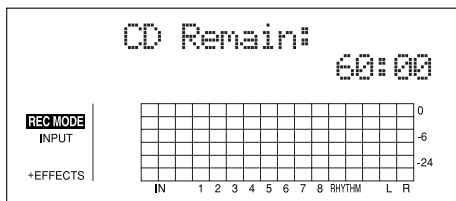

NOTE

With finalized discs, discs that have been used for data backup, and other discs that cannot be used as audio CDs, a remaining time of "0" is indicated.

Playing Back Audio CDs

Let's now listen to the audio CD we have just created using the BR-900CD's CD-R/RW drive. In addition to CD-R discs, this drive can be used to play back CD-RW discs that cannot be played on standard CD players. Naturally, you will also be able to listen to commercially produced audio CDs on this drive, and it can even play back audio CDs created using the BR-900CD that have not yet been finalized.

NOTE

If you are working with an audio CD created with the BR-900CD, you can play back and check the sounds on the CD even before finalizing it. Please note, however, that depending on the type of disc used and the data on it, songs may not play back properly all the way to the end. If you want to ensure that songs play back correctly, finalize (p. 143) the disc.

MEMO

Songs recorded on an audio CD are often referred to as "tracks." Be careful to avoid confusing these tracks with the BR-900CD's audio tracks.

1. Insert the audio CD into the CD-R/RW drive.
2. Press [CD-R/RW].

The CD menu screen will appear.

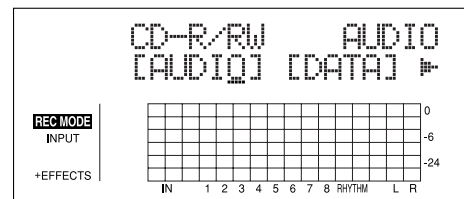

3. Press CURSOR [◀][▶] to move the cursor to "AUDIO," and press [ENTER].

The Audio CD menu screen will appear.

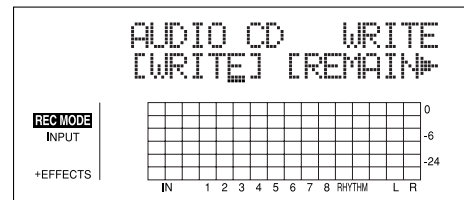

4. Press CURSOR [◀][▶] to move the cursor to "PLAY/IMP," and press [ENTER].

The Audio CD player screen will appear.

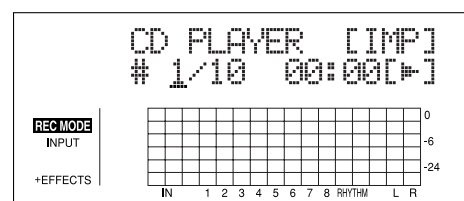

- Use the TIME/VALUE dial to select the song that you want to listen to.

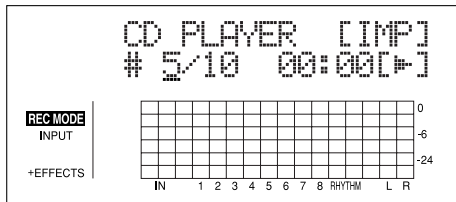

- Press [PLAY].

The message “Now Playing...” will appear, and playback of the audio CD will begin.

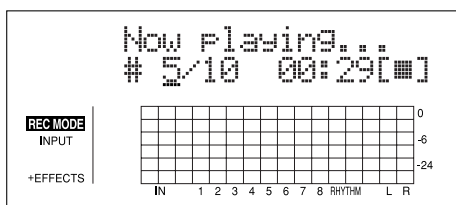

The buttons work as shown below.

- [STOP] Stop
- [PLAY] Play
- [REW] Rewind
- [FF] Fast forward

- If you want to finish playback of the audio CD, press [EXIT] several times to return to the Play screen.

- Press the CD-R/RW drive’s EJECT button to eject the disc.

It may take a period of several seconds before the disc is actually ejected.

NOTE

When an audio disc is inserted into the CD-R/RW drive, the message “Now Checking...” may remain on the screen for a relatively long time. This period of time is required for reading of the data stored on the audio CD and it is not the result of a malfunction.

Enabling Playback on CD Players (Finalize)

If you intend to play a audio CD that was written using the BR-900CD’s CD-R/RW drive on a standard CD player, the audio CD must be finalized. Audio CD-R/RW discs can be finalized at any time to enable playback on this type of player.

MEMO

What is finalizing?

In addition to the audio data itself, other information describing the position and time of this data is also written to audio CDs. This process is known as “Finalizing.”

If you finalize:

When finalization has been carried out, you will be able to play your audio CD on a standard CD player. Note, however, that you will no longer be able to add songs to a finalized CD.

Furthermore, the finalization of audio CDs containing only one short song is wasteful, since the remaining empty space on such discs can no longer be used.

For this reason, you should aim to carry out finalizing of a CD disc only when it is nearly full of songs.

If you don’t finalize:

It will not be possible to play your audio CD on a standard CD player until it has been finalized; however, you can keep adding songs to the disc until this process is carried out. Whenever you want to play your audio CD on a standard CD player, you should perform finalization.

- Insert the CD-R/RW disc to be finalized into the BR-900CD’s CD-R/RW drive.

The drive’s access indicator will begin to flash. Wait until this indicator stops flashing and turns off before proceeding.

- Press [CD-R/RW].

The CD menu screen will appear.

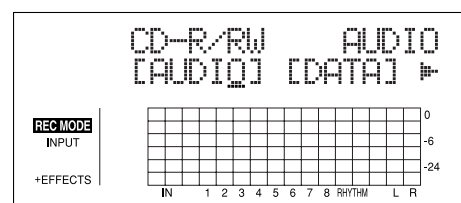

3. Press CURSOR [\leftarrow] [\rightarrow] to move the cursor to "AUDIO," and press [ENTER].

The Audio CD menu screen will appear.

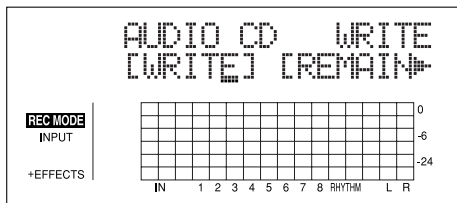

4. Press CURSOR [\leftarrow] [\rightarrow] to move the cursor to "FINAL," and press [ENTER].

The message "Finalize CD OK?" will appear.

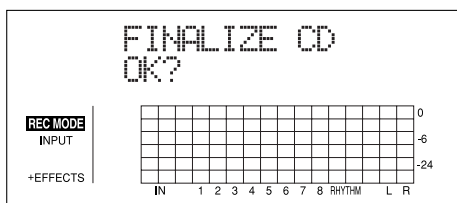

5. Press [ENTER] (YES). (If you want to cancel finalization, press [EXIT] (NO).)

Finalization will begin and the state of progress will be displayed. When the message "Complete" appears and the track buttons begin to flash, the finalization is complete.

6. Press [EXIT] several times to return to the Play screen.
7. Press the CD-R/RW drive's EJECT button to eject the disc.

This enables the CD-R/RW disc to be played back on regular consumer CD players.

NOTE

- Once finalization has been started, it will not be possible to cancel this process.
- In certain cases, a period of several seconds will pass before the disc is actually ejected.

Using the CD-R/RW Drive to Exchange Data

The BR-900CD's built-in CD-R/RW drive can be used to exchange data in the following ways:

- Storing of songs and other data on the memory card to CD-R/RW discs (Backup)
- Reading songs and other backup data back into the memory card (Recover)
- Exchanging of waveform data with a PC

NOTE

When you use the CD-R/RW drive, you must use only the supplied AC adaptor. The CD-R/RW drive cannot be used while running on battery power.

Saving Recorded Songs to CD-R/RW Discs (Backup)

Although the songs you've recorded and created are stored on the memory card, all of this data would be lost in the unlikely event that the memory card was damaged. For this reason, we recommend that you also save your songs on CD-R/RW discs (Backup).

Once songs have been backed up in this way, it will also be possible to read them from the CD-R/RW discs into another BR-900CD.

■ Precautions for backup

- If a CD-R disc selected for backup already contains data, the message "Not Blank Disc!" will appear and backup will not be possible. Always use an empty disc for this operation. If, on the other hand, you are using a CD-RW disc that already contains data, the message "Erase Disc?" will be displayed. If you then press [ENTER] (YES), the BR-900CD will begin erasing data from this disc.
- If the total size of the songs and other data you intend to back up exceeds the capacity of a single CD-R/RW disc, you will be able to perform a backup using as many discs as necessary. In this case, you will need to have a number of blank CD-R/RW discs on hand, and during the backup process, you should insert and remove them as requested on-screen.
- To cancel writing to a CD-R/RW disc, press [EXIT] (NO). When the message "Cancel?" appears, press [ENTER] (YES) to confirm cancellation. (A certain amount of time may pass between pressing of [EXIT] (NO) and display of the confirmation message.) Please note, however, that no guarantee can be made regarding the state of the data written before cancellation.

Backing up a song to a CD-R/RW disc one at a time (Song Backup)

1. Insert an empty CD-R/RW disc into the BR-900CD's CD-R/RW drive.

The drive's access indicator will begin to flash. Wait until this indicator stops flashing and turns off before proceeding.

2. Press [CD-R/RW].

The CD menu screen will appear.

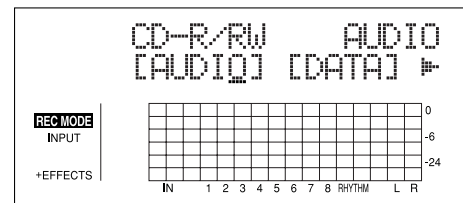

3. Press CURSOR [◀] [▶] to move the cursor to "DATA," and press [ENTER].

The Data CD menu screen will appear.

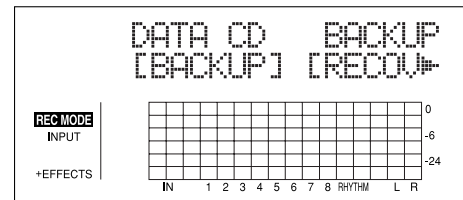

4. Press CURSOR [◀] [▶] to move the cursor to "BACKUP," and press [ENTER].

The Backup menu screen will appear.

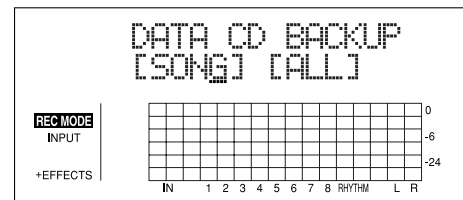

5. Press CURSOR [◀] [▶] to move the cursor to "SONG," and press [ENTER].

The Song backup screen will appear.

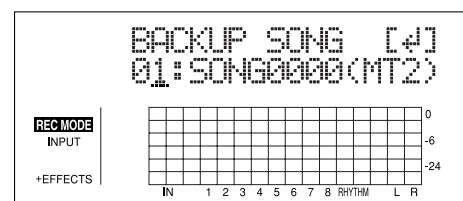

Using the CD-R/RW Drive to Exchange Data

6. Use the TIME/VALUE dial to select the song you want to back up, and press [ENTER].

The Write Speed screen will appear.

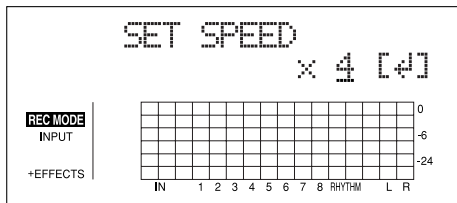

7. Use the TIME/VALUE dial to set the write speed, and press [ENTER].

The message "Write sure?" will appear.

NOTE

- The range of available write speeds can sometimes be limited by the type of media being used. In such a case, the BR-900CD will allow you to select only the supported speeds.
- If you are using CD-R or CD-RW discs intended for high-speed writing, the frequency of write errors may increase if the x2 or x4 speed is selected. It is recommended that you use the x8 speed for high-speed discs.

8. Press [ENTER] (YES).

Writing to the CD-R/RW disc will begin.

When the message "Completed!" appears, it indicates that the backup has been successfully completed.

Saving all of the songs on a memory card to a CD-R/RW disc (All Backup)

1. Insert an empty CD-R/RW disc into the BR-900CD's CD-R/RW drive.

The drive's access indicator will begin to flash. Wait until this indicator stops flashing and turns off before proceeding.

2. Press [CD-R/RW].

The CD menu screen will appear.

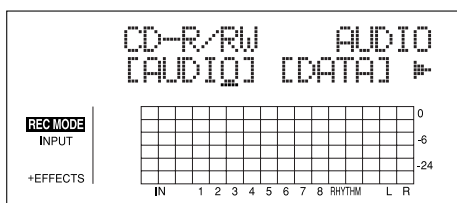

3. Press CURSOR [◀] [▶] to move the cursor to "DATA," and press [ENTER].

The Data CD menu will appear.

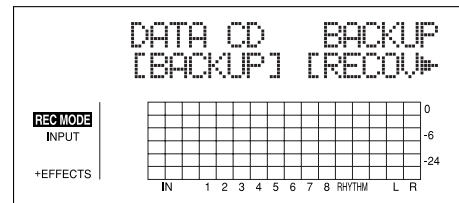

4. Press CURSOR [◀] [▶] to move the cursor to "BACKUP," and press [ENTER].

The Backup menu screen will appear.

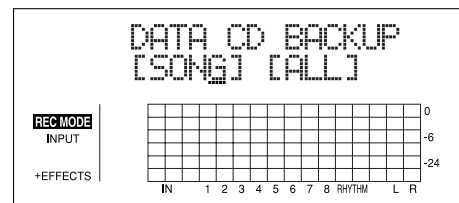

5. Press CURSOR [◀] [▶] to move the cursor to "ALL," and press [ENTER].

The Write Speed screen will appear.

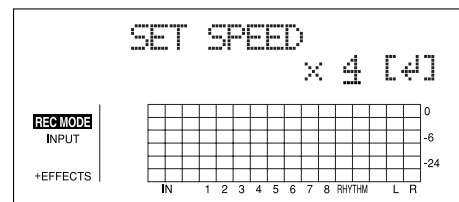

6. Use the TIME/VALUE dial to set the write speed, and press [ENTER].

The message "Are you sure?" will appear.

NOTE

- The range of available write speeds can sometimes be limited by the type of media being used. In such a case, the BR-900CD will allow you to select only the supported speeds.
- If you are using CD-R or CD-RW discs intended for high-speed writing, the frequency of write errors may increase if the x2 or x4 speed is selected. It is recommended that you use the x8 speed for high-speed discs.

7. Press [ENTER] (YES).

Writing to the CD-R/RW disc will begin.

When the message "Completed!" appears, it indicates that the backup has been successfully completed.

Loading Saved Songs to a Memory Card (Recover)

Loading saved songs to a memory card one at a time (Song Recover)

1. Insert a CD-R/RW disc containing backup songs into the BR-900CD's CD-R/RW drive.

The drive's access indicator will begin to flash. Wait until this indicator stops flashing and turns off before proceeding.

2. Press [CD-R/RW].

The CD menu screen will appear.

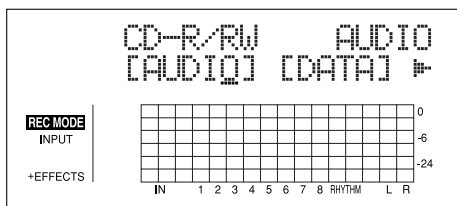

3. Press CURSOR [◀] [▶] to move the cursor to "DATA," and press [ENTER].

The Data CD menu screen will appear.

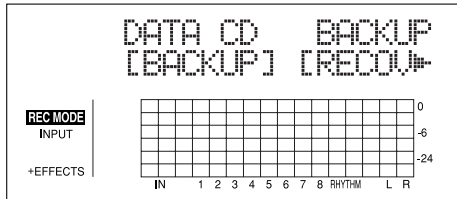

4. Press CURSOR [◀] [▶] to move the cursor to "RECOVER," and press [ENTER].

The Recover menu screen will appear.

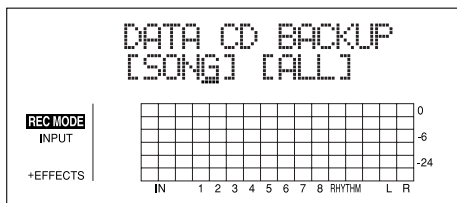

5. Press CURSOR [◀] [▶] to move the cursor to "SONG," and press [ENTER].

The Song recover screen will appear.

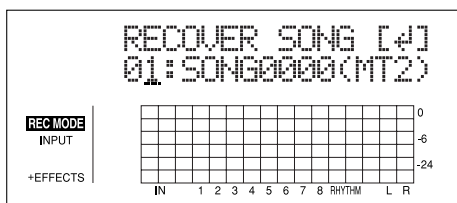

6. Use the TIME/VALUE dial to select the song you want to recover, and press [ENTER].
The message "Are you sure?" will appear.

7. Press [ENTER] (YES).

The recovered song will begin.

When the message "Completed!" appears, it indicates that the recovered song has been successfully completed.

MEMO

The recovered songs will be saved in sequence on the memory card using the available song numbers.

NOTE

"Card Full!" may appear in the display when you use Song Recover in an attempt to load a song that was in the process of being recorded when the memory card became full ("Card Full!" was displayed). If this occurs, use "All Recover" to load the song.

Loading all saved songs to a memory card (All Recover)

NOTE

Note that executing All Recover deletes all of the data existing on the memory card. Be sure to back up any required data before executing All Recover.

1. Insert a CD-R/RW disc containing backup songs into the BR-900CD's CD-R/RW drive.

The drive's access indicator will begin to flash. Wait until this indicator stops flashing and turns off before proceeding.

2. Press [CD-R/RW].

The CD menu screen will appear.

3. Press CURSOR [◀] [▶] to move the cursor to "DATA," and press [ENTER].

The Data CD menu screen will appear.

4. Press CURSOR [◀] [▶] to move the cursor to "RECOVER," and press [ENTER].

The Recover menu screen will appear.

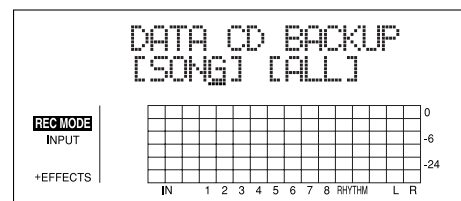

5. Press CURSOR [◀] [▶] to move the cursor to "ALL," and press [ENTER].

The message "Are you sure?" will appear.

6. Press [ENTER] (YES).

The recovered songs will begin.

When the message "Completed!" appears, it indicates that the recovered songs has been successfully completed.

Copying and Writing Waveform Data

NOTE

This procedure requires a computer equipped with a drive capable of writing to CD-R/RW discs.

If you have a computer equipped with a CD-R/RW drive, you can use CD-R/RW discs to transfer waveform data between multiple BR-900CDs.

You can, for example, use these discs to copy waveform data created with the audio software on your computer and then paste the data to audio tracks. You can also take audio track data recorded with the BR-900CD and copy it to your computer for editing.

Copying waveform data from a computer to the audio tracks (WAV/AIFF Import)

NOTE

- To be eligible for import, waveform data must meet the following criteria. In most cases, you will not be able to import other kinds of data.
 - Use "ISO 9660 Level 2, Mode 1" to write the data to the CD-R/RW disc.
 - WAV or AIFF format
 - Mono or Stereo
 - 8-bit or 16-bit
 - Sampling Rate: 44.1 kHz
- Audio data must be at least one second in length.
- Name waveform data using less than eight letters followed by a three-character extension.
- The loop point settings within an AIFF file will be ignored.

1. Using a PC, burn and finalize a CD-R/RW disc containing the waveform data that you want to import.

For instructions on how to write waveform data to CD-R/RW discs, refer to your computer and CD-R/RW drive owner's manuals.

2. Place the CD-R/RW disc in the BR-900CD's CD-R/RW drive.

The drive's access indicator will begin to flash. Wait until this indicator stops flashing and turns off before proceeding.

3. Press [CD-R/RW].

The CD menu screen will appear.

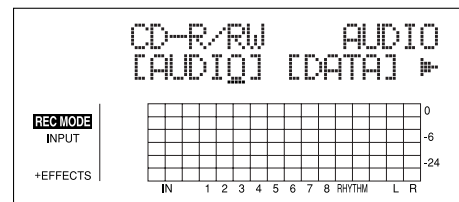

4. Press CURSOR [◀] [▶] to move the cursor to "DATA," and press [ENTER].

The Data CD menu screen will appear.

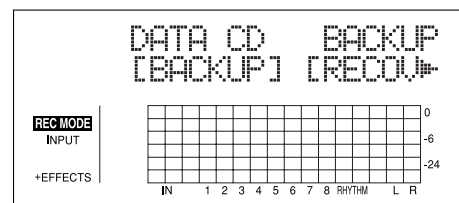

5. Press CURSOR [◀] [▶] to move the cursor to "WAV," and press [ENTER].

The WAV/AIFF menu screen will appear.

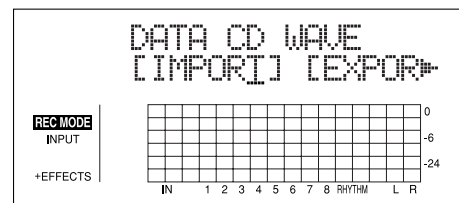

6. Press CURSOR [◀] [▶] to move the cursor to "IMPORT," and press [ENTER].

A list of the audio data files contained on the current CD-R/RW disc will appear.

If the WAV files are collected in a folder, then the folder name is displayed. To show the WAV files within the folder, press [ENTER].

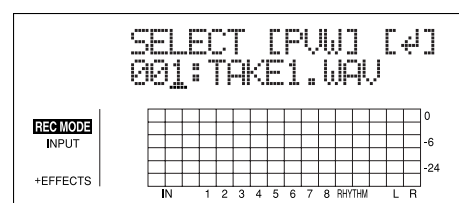

You can preview the sounds by moving the cursor to "PVW" and pressing [ENTER]. You can stop the sound by moving the cursor to "PVW" and pressing [ENTER] once more.

You can press [PLAY] to preview the sounds, and press [STOP] to stop the sounds.

- Use the TIME/VALUE dial to select the waveform data files you want to import, and press [ENTER].
The screen for specifying the import destination appears.

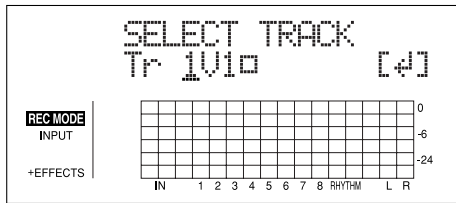

- Use the TIME/VALUE dial to specify the import-destination track, and press [ENTER].
Copying of the waveform data begins.

When "Completed!" appears, the import is finished.

The waveform data is imported at the beginning of the tracks. If you want to change the location at which this data is written, use Track Edit (p. 70) to move the data after it has been imported.

Copying WAV/AIFF files as drum sounds (Tone Load)

NOTE

- The Rhythm and Tone Load functions cannot be used when tracks are bounced directly to a CD (p. 59).
- Wave data in the following formats can be imported. You cannot import wave data in other formats.
 - Use "ISO 9660 Level 2, Mode 1" to write the data to the CD-R/RW disc.
 - WAV or AIFF format
 - Mono or Stereo
 - 8-bit or 16-bit
 - Sampling Rate: 44.1 kHz
- Compressed WAV files or AIFF files cannot be loaded.
- Extremely short waveform data (less than approximately 100 msec) cannot be loaded.
- The loop point settings within an AIFF file will be ignored.
- Add the extension "WAV" to imported WAV files and the extension "AIF" to imported AIFF files.
- You can load drum sounds of up to 13 seconds for a single drum kit.

(Example)

Kick: 3 seconds, snare: 3 seconds,
crash cymbal: 7 seconds → Total 13 seconds

- Stereo WAV and AIFF files are loaded as "mono" sounds with the left and right sides mixed.

- Using a PC, burn and finalize a CD-R/RW disc containing the waveform data that you want to import.
For instructions on how to write waveform data to CD-R/RW discs, refer to your computer and CD-R/RW drive owner's manuals.

- Place the CD-R/RW disc in the BR-900CD's CD-R/RW drive.

The drive's access indicator will begin to flash. Wait until this indicator stops flashing and turns off before proceeding.

- Press [CD-R/RW].

The CD menu screen will appear.

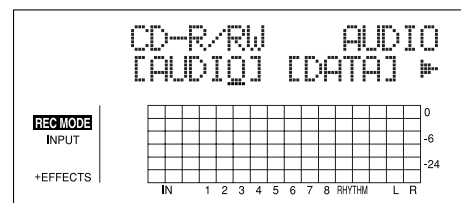

- Press CURSOR [◀] [▶] to move the cursor to "DATA," and press [ENTER].

The Data CD menu screen will appear.

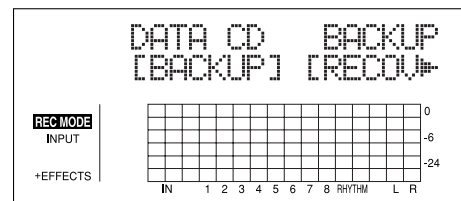

- Press CURSOR [◀] [▶] to move the cursor to "TONE," and press [ENTER].

A list of the waveform data files contained on the current CD-R/RW disc will appear.

If the WAV files are collected in a folder, then the folder name is displayed. To show the WAV files within the folder, press [ENTER].

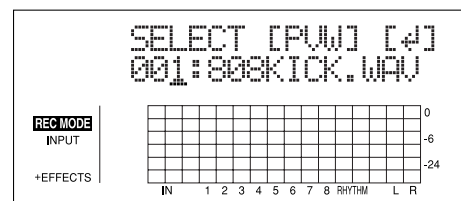

You can preview the sounds by moving the cursor to "PVW" and pressing [ENTER]. You can stop the sound by moving the cursor to "PVW" and pressing [ENTER] once more.

You can press [PLAY] to preview the sounds, and press [STOP] to stop the sounds.

Using the CD-R/RW Drive to Exchange Data

- Use the TIME/VALUE dial to select the data files you want to import, and press [ENTER].

The Drum kit select screen appears.

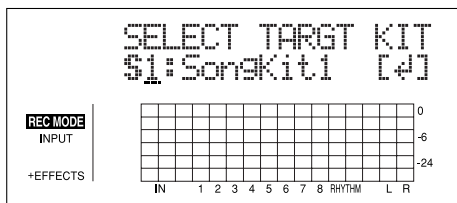

- Use the TIME/VALUE dial to specify the drum kit, and press [ENTER].

The Drum sound select screen appears.

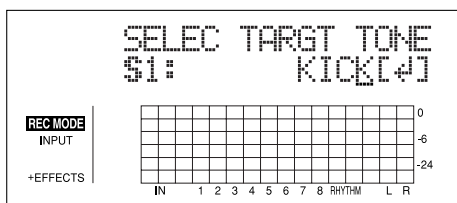

- Use the TIME/VALUE dial to specify the drum sound, and press [ENTER].

Copying of the waveform data begins.

When "Completed!" appears, the import is finished.

Copying audio track waveform data to computers (WAV/AIFF Export)

You can write data for specified tracks to a CD-R/RW disc as waveform data, then import the waveform data to the computer, using your computer to read the CD-R/RW disc.

NOTE

You will be unable to use CD-RW discs if your computer is only equipped with a CD-ROM or CD-R drive. In this case, used CD-R discs.

- Place a writable CD-R/RW disc (a blank disc) in the BR-900CD's CD-R/RW drive.

The drive's access indicator will begin to flash. Wait until this indicator stops flashing and turns off before proceeding.

- Press [CD-R/RW].

The CD menu screen will appear.

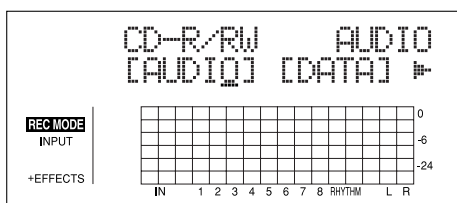

- Press CURSOR [◀] [▶] to move the cursor to "DATA," and press [ENTER].

The Data CD menu will appear.

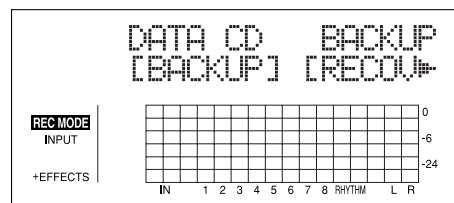

- Press CURSOR [◀] [▶] to move the cursor to "WAV," and press [ENTER].

The WAV/AIFF screen will appear.

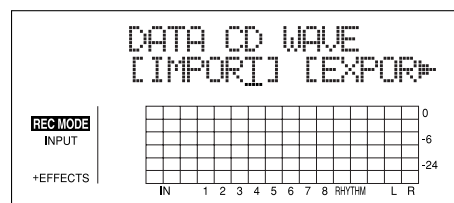

- Press CURSOR [◀] [▶] to move the cursor to "EXPORT," and press [ENTER].

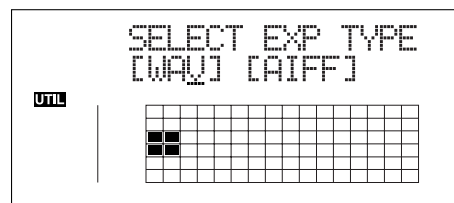

- Press CURSOR [◀] [▶] to select the file format, then press [ENTER].

The Waveform Data Export screen appears.

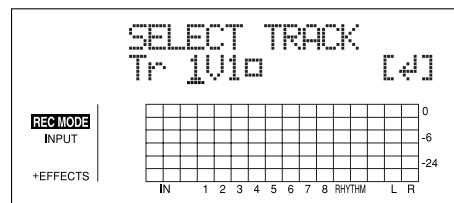

- Use the TIME/VALUE dial to specify the tracks you want to export.

The Write Speed screen will appear.

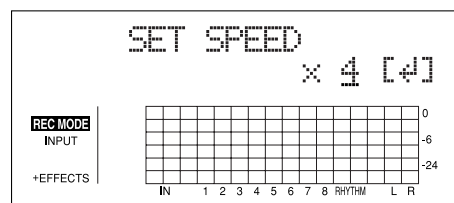

- Use the **TIME/VALUE** dial to set the write speed, and press **[ENTER]**.

The message “Are you sure?” appears.

NOTE

The range of available write speeds can sometimes be limited by the type of media being used. In such a case, the BR-900CD will allow you to select only the supported speeds.

- Press **[ENTER]** (YES) again.

Writing to the CD-R/RW disc begins.

When “Completed!” appears, the writing is finished.

The following files will have been written to the CD-R/RW disc in ISO9660 Level 2, Mode 1 format.

Track 1, V-Track 1	T01__01.WAV or T01__01.AIF
Track 1, V-Track 2	T01__02.WAV or T01__02.AIF
Track 1, V-Track 3	T01__03.WAV or T01__03.AIF
:	:
Track 2, V-Track 7	T02__07.WAV or T02__07.AIF
Track 2, V-Track 8	T02__08.WAV or T02__08.AIF
:	:
Track 3/4, V-Track 1	T0304_01.WAV or T0304_01.AIF
Track 3/4, V-Track 2	T0304_02.WAV or T0304_02.AIF
:	:
Track 7/8, V-Track 7	T0708_07.WAV or T0708_07.AIF
Track 7/8, V-Track 8	T0708_08.WAV or T0708_08.AIF

- Press **[EXIT]** several times to return to the Play screen.

- Press the CD-R/RW drive’s **EJECT** button to eject the disc.

- Use the application on your computer to copy the data from the CD-R/RW disc.

NOTE

- If a CD-R disc that already has data written to it is loaded, the message “Not Blank Disc” appears, and you cannot proceed with the export. Be sure to use only blank discs.
- If a CD-RW disc that already has data written to it is loaded, the message “Erase Disc?” appears. Pressing **[ENTER]** (YES) here begins erasure of the disc. After the disc has been erased, the export process will continue.
- When a mono track is specified as the source for exporting, the data is written as a mono waveform file. When a stereo track is specified, the data is written as a stereo waveform file.
- Tracks 7/8 are fixed as a permanent stereo pair, and so cannot be specified as mono tracks.

- To quit writing to the disc while writing is still in progress, press **[EXIT]** (NO). When the message “Cancel?” appears, press **[ENTER]** (YES); writing is cancelled (it may take some time after you press **[EXIT]** (NO) for the message to appear). However, no guarantee can be made for the utility of the content up to the time writing is cancelled.
- It will not be possible to reuse a CD-R disc for which writing was canceled before completion.

Using SMF

Playing SMFs using external MIDI instruments (SMF Player)

You can use the BR-900CD to read SMFs from CD-R/RW discs and play these files using MIDI instruments connected to the MIDI OUT port.

Any SMFs that satisfy the following conditions can be played in this way.

- Format:** 0 or 1
- File size:** 240 KB maximum (Note that this will vary slightly based on the SMF content.)
- System Exclusive:** Packet sizes of 512 bytes or less

- Connect a MIDI cable between the **MIDI OUT** port on the BR-900CD and the **MIDI IN** port on your external MIDI sound module.

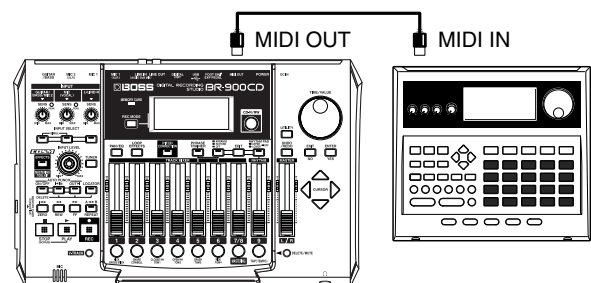

- Insert a CD-R/RW disc containing SMFs into the CD-R/RW drive.

The drive’s access indicator will begin to flash. Wait until this indicator stops flashing and turns off before proceeding.

- Press **[CD-R/RW]**.

The CD menu screen will appear.

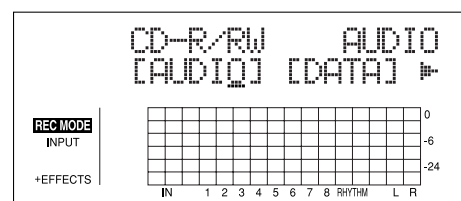

Using the CD-R/RW Drive to Exchange Data

4. Press CURSOR [◀] [▶] to move the cursor to "DATA," and press [ENTER].

The Data CD menu screen will appear.

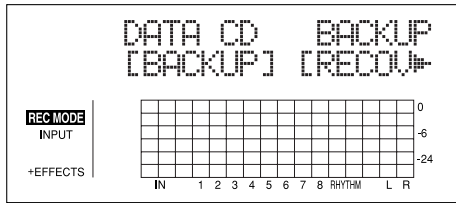

5. Press CURSOR [◀] [▶] to move the cursor to "SMF," and press [ENTER].

The SMF menu screen will appear.

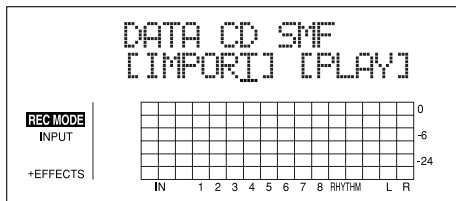

6. Press CURSOR [◀] [▶] to move the cursor to "PLAY," and press [ENTER].

The SMF play screen appears.

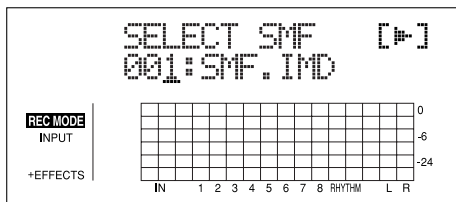

7. Use the TIME/VALUE dial to select the SMF to be played.

If the SMFs are collected in a folder, then the folder name is displayed. To show the SMFs within the folder, press [ENTER].

8. Press CURSOR [◀] [▶] to move the cursor to [▶] and press [ENTER].

The BR-900CD will start playback.

9. To stop playback, press CURSOR [◀] [▶] to move the cursor to [■] and press [ENTER].

You can use [START] and [STOP] to start and stop SMF playback.

NOTE

In cases where the SMF contains a large amount of MIDI data, playback of the file may be sluggish.

Loading drum patterns from the CD-R/RW drive (SMF Import)

You can import SMFs (Standard MIDI Files) stored on PC as song patterns. You can easily increase your collection of song patterns by creating SMFs on your computer or other device and copying them to memory cards.

Any SMFs that satisfy the following conditions can be played in this way.

- Format:** 0 or 1
File size: 240 KB maximum (Note that this will vary slightly based on the SMF content.)

NOTE

When importing GM/GS/XG-compatible SMFs, MIDI Channel 10 is generally assigned as the channel used for rhythm performances. Thus, only the data on MIDI Channel 10 in the SMF is isolated and imported by the BR-900CD. Note that the data on other channels is disregarded.

- Using a PC, burn a CD-R/RW disc containing the SMFs you want to import.
- Insert this CD-R/RW disc into the BR-900CD's CD-R/RW drive.

The drive's access indicator will begin to flash. Wait until this indicator stops flashing and turns off before proceeding.

- Press [CD-R/RW].

The CD menu screen will appear.

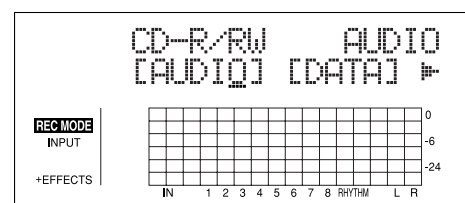

- Press CURSOR [◀] [▶] to move the cursor to "DATA," and press [ENTER].

The Data CD menu screen will appear.

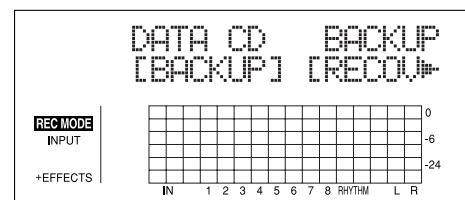

5. Press CURSOR [◀] [▶] to move the cursor to “SMF,” and press [ENTER].

The SMF menu screen will appear.

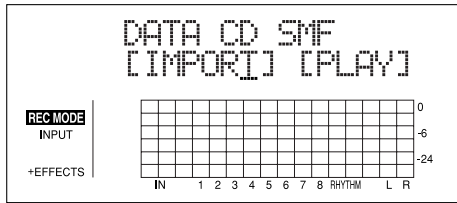

6. Press CURSOR [◀] [▶] to move the cursor to “IMPORT,” and press [ENTER].

The SMF import screen appears.

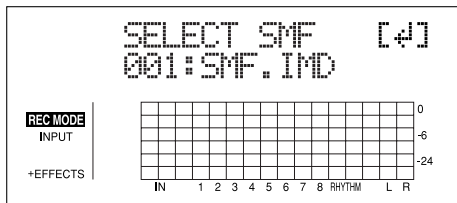

If the SMFs are collected in a folder, then the folder name is displayed. To show the SMFs within the folder, press [ENTER].

7. Use the TIME/VALUE dial to select the SMFs you want to import, and press [ENTER].

The screen for specifying the import destination pattern number appears.

8. Use the TIME/VALUE dial to specify the import-destination pattern number and press [ENTER].

Copying of the SMF begins.

When “Completed!” appears, the import is finished.

Erasing Data from a CD-RW Disc (CD-RW Erase)

If you are using CD-RW discs, you will be able to erase unneeded data from the discs and reuse them for data storage.

NOTE

- This process results in all data being erased from a disc.
- Data erasure is possible only with CD-RW discs. Data cannot be erased from CD-R discs.

1. Insert the CD-RW disc to be erased into the BR-900CD's CD-R/RW drive.

The drive's access indicator will begin to flash. Wait until this indicator stops flashing and turns off before proceeding.

2. Press [CD-R/RW].

The CD menu screen will appear.

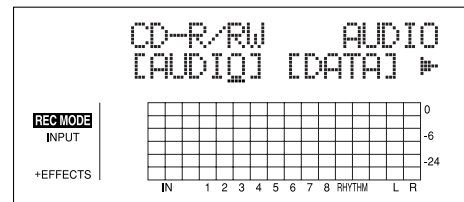

3. Press CURSOR [◀] [▶] to move the cursor to “ERASE,” and press [ENTER].

The message “Are you sure?” will appear.

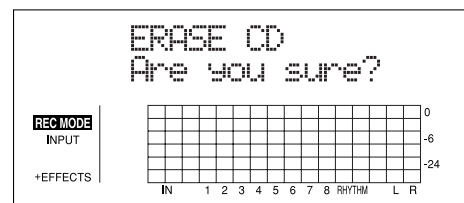

4. Press [ENTER] (YES).

Press [EXIT] (NO) to cancel deletion.

The data erasure will begin and the state of progress will be displayed. When the message “Completed!” appears, it indicates that erasing has been completed.

5. Press [EXIT] several times to return to the Play screen.
6. Press the CD-R/RW drive's EJECT button to eject the disc.

NOTE

- Once erasing has been started, it will not be possible to cancel this process.
- The amount of time required for erasing data will depend on the type of CD-RW disc used and the volume of data that it contains.
- In certain cases, a period of several seconds will pass before the disc is actually ejected.

Importing Songs from CDs to Audio Tracks

The BR-900CD allows you to import selected songs from a audio CD to audio tracks. (CD-R/RW Write)

NOTE

Important Notice

- The BR-900CD and its CD-R/RW drive are designed to allow you to reproduce material for which you own the copyright, or material for which you have been granted permission to copy by the copyright owner. Accordingly, the reproduction of audio CDs or other copyrighted material without the permission of the copyright owner and the circumvention of technologies such as SCMS, which prohibit second-generation and later copies, constitutes copyright infringement and may incur penalties, even in cases where such reproduction is for your own personal use and enjoyment (private use). Consult a copyright specialist or special publications for more information regarding the acquisition of copyright permission from copyright holders.
- The BR-900CD does not allow you to import all songs from a audio CD at once. Songs must be imported one at a time.

1. Insert a audio CD into the BR-900CD's CD-R/RW drive.

The drive's access indicator will begin to flash. Wait until this indicator stops flashing and turns off before proceeding.

2. Press [CD-R/RW].

The CD menu screen will appear.

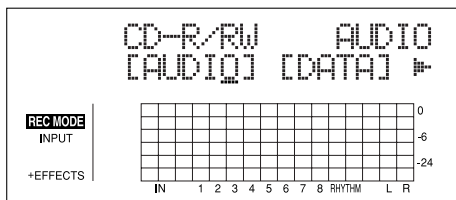

3. Press CURSOR [◀][▶] to move the cursor to "AUDIO," and press [ENTER].

The Audio CD menu screen will appear.

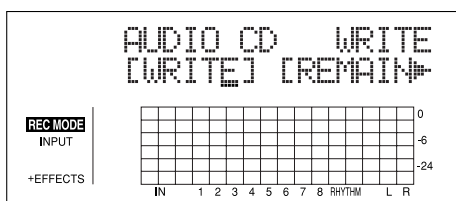

4. Press CURSOR [◀][▶] to move the cursor to "PLAY/IMP," and press [ENTER].

The Audio CD player screen will appear.

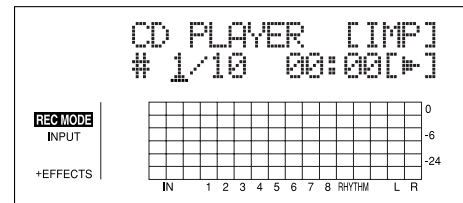

5. Use the TIME/VALUE dial to select the number of the song to be imported.

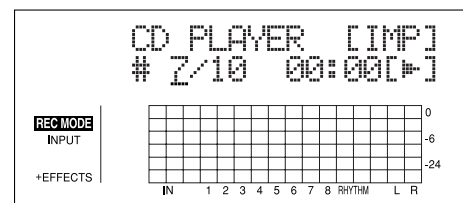

6. Use [CURSOR] to move the cursor to "[IMP]," and press [ENTER].

The screen for specifying the import destination appears.

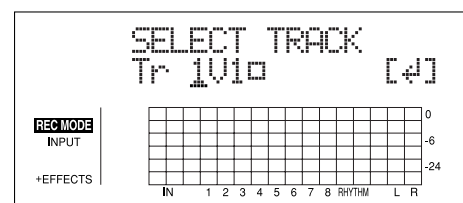

7. Use the TIME/VALUE dial to select the destination track for import, and press [ENTER].

The message "Now Importing..." will appear and import to the audio track will begin. When the message "Completed!" appears, it indicates that the import procedure has been successfully completed.

NOTE

When an audio disc is inserted into the CD-R/RW drive, the message "Now Checking..." may remain on the screen for a relatively long time. This period of time is required for reading of the data stored on the audio CD and it is not the result of a malfunction.

Section 6

Using MIDI

MIDI Fundamentals

By using MIDI to connect the BR-900CD to other MIDI-capable devices, you can perform the following:

- Play rhythm performances on external MIDI sound module
- Synchronize with external MIDI sequencers and rhythm machines
- Control MMC-compatible devices from the BR-900CD

This section provides a basic description of MIDI and explains the various ways it can be used.

What is MIDI?

MIDI stands for “Musical Instrument Digital Interface.” MIDI is a global standard devised so that performance data, program change data, and other similar information could be exchanged among electronic musical instruments and computers. If a device is MIDI compatible, it will be able to exchange performance data with other MIDI compatible devices, even if they are of a different type or brand.

MIDI Connectors

MIDI messages (i.e., the data handled by MIDI) are exchanged using the following three types of MIDI port.

MIDI IN:

This connector accepts the MIDI messages arriving from other MIDI devices.

MIDI OUT:

All the MIDI messages from the BR-900CD are sent out from this connector.

MIDI THRU:

This connector re-transmits all the MIDI messages that arrive at the MIDI IN connector.

NOTE

The BR-900CD is equipped with a MIDI OUT port, but not with MIDI IN and MIDI THRU ports.

MIDI Channels

The MIDI standard allows data to be exchanged among multiple MIDI-compatible devices using a single MIDI cable, and this is made possible by what are known as MIDI channels.

In simple terms, a MIDI channel is quite similar to a TV channel. For example, you can change TV channels to watch programs from a variety of broadcasters. In this type of situation, information is communicated only when the channel on the transmitting end matches the channel on the receiving end.

Likewise, with MIDI as well, if the transmitting device is (for example) set to MIDI channel 1, MIDI messages will be received only if the MIDI channel on the receiving end is also set to 1.

MIDI Implementation Charts

MIDI makes it possible for a vast range of electronic musical devices to communicate with each other. However, this does not mean that every MIDI device can handle every single type of MIDI message. In reality, two MIDI-compatible devices can only exchange the MIDI messages that are supported by both.

The user’s manual for any MIDI-compatible device will contain a MIDI Implementation Chart, and this chart allows you to quickly find out which MIDI messages the device in question can transmit and receive.

When two MIDI devices are to be used together, you should compare their MIDI implementation charts to make sure that exchange of the required MIDI messages will be possible.

For more detailed information regarding the BR-900CD’s MIDI characteristics, refer to “MIDI Implementation” (p. 216).

Synchronizing with MIDI Devices

Using the Rhythm to Play an External MIDI Sound Module

Perform the procedure given below to use a MIDI sound module and choose the sounds you desire for the Rhythm.

1. Use a MIDI cable to connect the BR-900CD and your MIDI sound module as shown in the diagram.

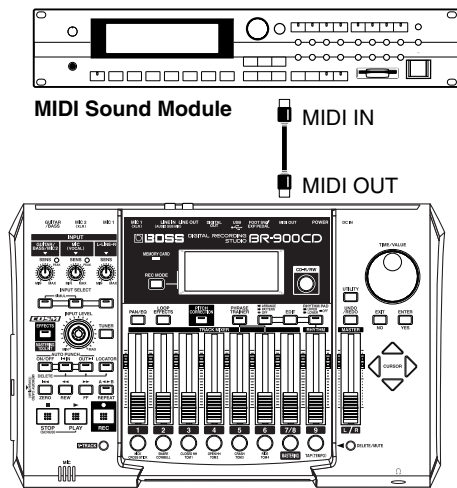

2. Press [UTILITY].
3. Press CURSOR [◀] [▶] to move the cursor to "SYNC," and press [ENTER].

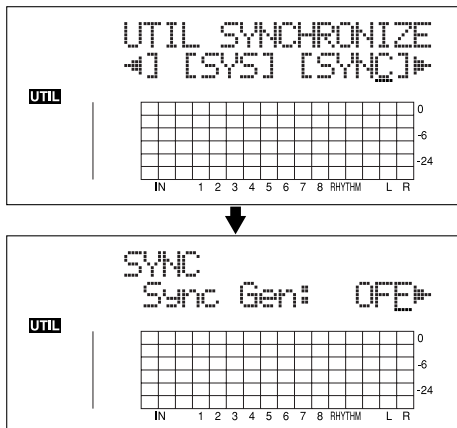

4. Press CURSOR [◀] [▶] to select "RhyMIDI ch: 10."

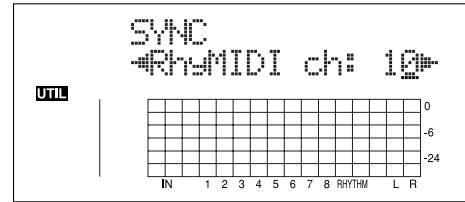

5. Turn the TIME/VALUE dial to set the MIDI channel (1-16).
If you select "OFF," note messages of the Rhythm will not be transmitted.
6. Press [UTILITY] (or press [EXIT] repeatedly) to return to the Play screen.

* During updating, "Keep power on!" appears in the upper line of the display, while the lower line shows what is being processed.

MEMO

The sounds produced by the Rhythm and their corresponding note numbers are given below.

Rhythm Sound	Note Number
Closs Stick	G1 (31)
Metronome (click)	A 1 (33)
Metronome (bell)	A#1 (34)
Kick	C 2 (36)
Snare	D 2 (38)
Tom 4	F 2 (41)
Closed Hi-hat	F#2 (42)
Tom 3	A 2 (45)
Open Hi-hat	A#2 (46)
Tom 2	C 3 (48)
Clash Cymbal	C#3 (49)
Tom 1	D 3 (50)
Ride Cymbal	D#3 (51)
Cowbell	G#3 (56)

Tone arrangement is based on GS/GM. In case your external MIDI sound module is not based on GS or GM, you will need to make settings on your external MIDI sound module to change the sounds that correspond to each note number. For details on making these settings, refer to the manual of your MIDI sound module.

* If you are using an external MIDI sound module to play the Rhythm, use the controls of the external MIDI sound module to adjust the volume level.

Synchronizing Playback with a MIDI Sequencer

The BR-900CD can operate in synchronization with a MIDI sequencer.

NOTE

When synchronizing with a MIDI sequencer, it is possible to synchronize the MIDI sequencer using the BR-900CD (i.e., with the BR-900CD as the master), but it is not possible to synchronize the BR-900CD with the MIDI sequencer (i.e., with the BR-900CD as the slave).

* For details on operation of your MIDI sequencer, refer to the operating manual for your device. For information regarding MMC, see p. 160.

Synchronized playback with the BR-900CD as the master

Follow the procedure given below to synchronize the MIDI sequencer using the BR-900CD.

1. Use a MIDI cable to connect the BR-900CD and your MIDI sequencer as shown in the diagram.

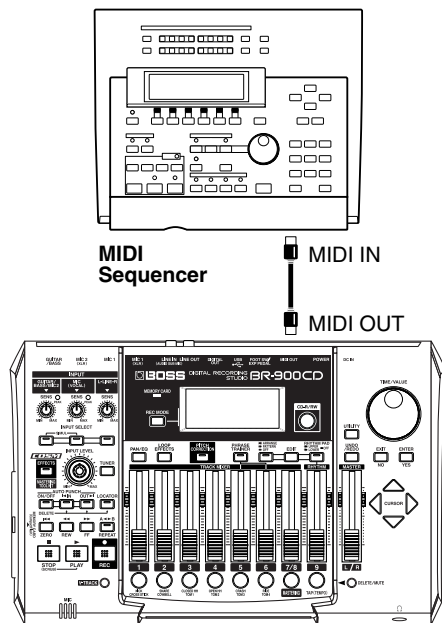

2. Press [UTILITY].
3. Press CURSOR [◀] [▶] to move the cursor to "SYNC," and press [ENTER].

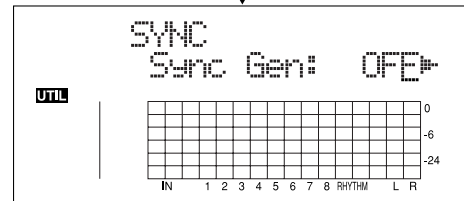
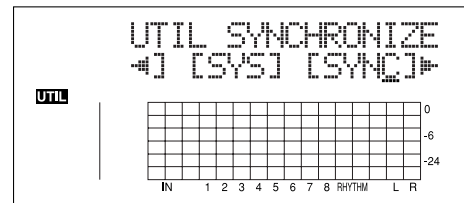

4. Press CURSOR [◀] [▶] to select "Sync Gen," and turn the TIME/VALUE dial to set the sync generator.

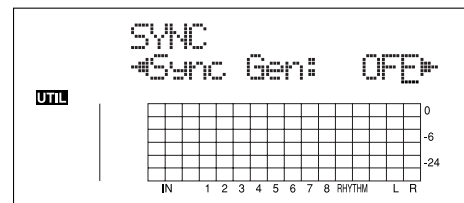

- OFF:** Synchronization signals will not be output.
- MTC:** MIDI Time Code will be transmitted.
- MCK:** Sends the MIDI clock based on the tempo set with the Rhythm (p. 120).

* If "OFF" or "MCK" is selected, proceed to step 6.

5. Press CURSOR [◀] [▶] to select "MTC Type," and turn the TIME/VALUE dial to set the MTC type.

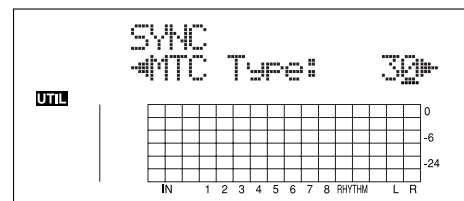

Verify the specifications of your MIDI sequencer and set the MTC type on the BR-900CD.

- 30:** 30 frames per second non-drop format. This is used by audio devices such as analog tape recorders, and for NTSC format black and white video (used in Japan and the U.S.).
- 29N:** 29.97 frames per second non-drop format. This is used for NTSC format color video (used in Japan and the U.S.).
- 29D:** 29.97 frames per second drop format. This is used for NTSC format broadcast color video (used in Japan and the U.S.).

- 25: 25 frame per second frame rate. This is used for SECAM or PAL format video, audio equipment, and film (used in Europe and elsewhere).
 - 24: 24 frame per second frame rate. This is used for video, audio devices, and film in the US.
6. Press [UTILITY] (or press [EXIT] repeatedly) to return to the Play screen.
 - * During updating, "Keep power on!" appears in the upper line of the display, while the lower line shows what is being processed.
 7. Just as when you synchronize a MIDI sequencer using external MTC, when you use the MCK, you can synchronize the MIDI sequencer using the external MIDI clock.
 8. Get the MIDI song data ready for playback.

When the BR-900CD begins playing, the MIDI sequencer will also begin playing in sync with it.

What are drop and non-drop formats?

There are two types of format used by NTSC video cassette recorders, non-drop and drop. With the non-drop format, the frames are continuous. On the other hand, in order to support NTSC color video, the drop format drops the first two frames of every minute excluding minutes 10, 20, 30, 40, and 50.

In most video and audio production, since formats with continuous frames are easier to deal with, non-drop is generally used. In contrast, in situations such as in broadcast, where the time code must match actual clock time, drop is used.

Setting the MTC offset

The offset sets the time required to align the song playback and MTC timing when synchronizing an external device using MTC from the BR-900CD.

1. Press [UTILITY].
2. Press CURSOR [◀] [▶] to move the cursor to "SYNC," and press [ENTER].

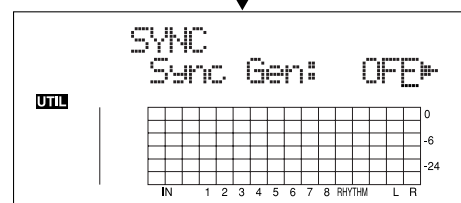
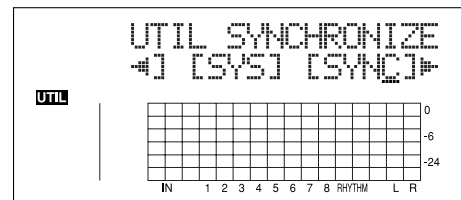

3. Press CURSOR [◀] [▶] to select "Offset," and turn the TIME/VALUE dial to set the time offset.

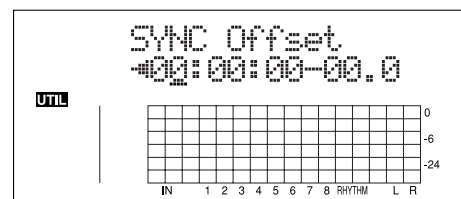

The offset is set as the difference between the "time to which to align the MTC timing" and the "time to which to align the song timing." For example, you want to have the external device play back with the MTC timing shown below when the song timing reaches "01h00m00s00," then set the offset as follows.

Song Timing	MTC for External Device	Offset Setting
01h00m00s00	01h30m00s00	00h30m00s00
01h00m00s00	00h30m00s00	23h30m00s00

4. Press [UTILITY] (or press [EXIT] repeatedly) to return to the Play screen.

* During updating, "Keep power on!" appears in the upper line of the display, while the lower line shows what is being processed.

Using MMC

MMC stands for "MIDI Machine Control." This is a protocol that uses MIDI System Exclusive messages to remotely control multiple recording devices from one device. Your BR-900CD supports the MMC protocol.

By using MMC, your BR-900CD can send commands such as PLAY, STOP, and FF to connected MIDI devices to operate them.

MEMO

Some MIDI devices do not support the BR-900CD's MMC functionality. If so, it will not be possible to operate them from the BR-900CD using the procedures described here. For details on the MMC functionality supported by the BR-900CD, read "MIDI Implementation" (p. 216).

Operating MMC-compatible devices with the BR-900CD

This section explains how to make settings for synchronizing the playback with a computer-based sequencer program that supports MMC and MTC. Make connections as shown in the diagram below.

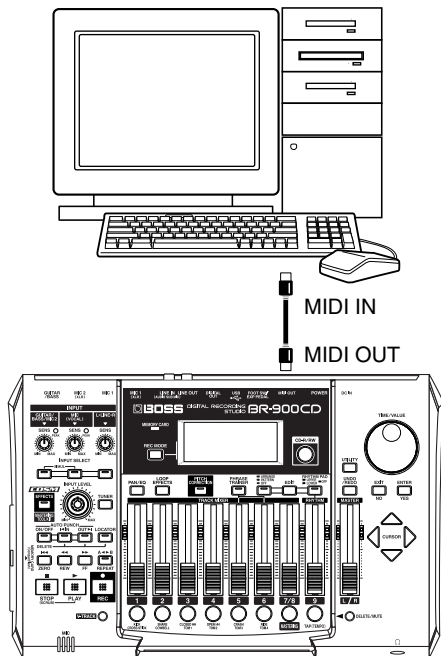

The BR-900CD will be the master for MMC and MTC.

Follow the procedure given below to operate the play, stop, fast-forward and other functions of a sequencer program with the BR-900CD.

1. Press [UTILITY].
2. Press CURSOR [◀] [▶] to move the cursor to "SYNC," and press [ENTER].

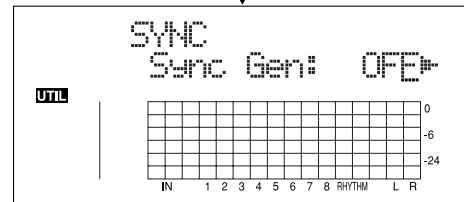
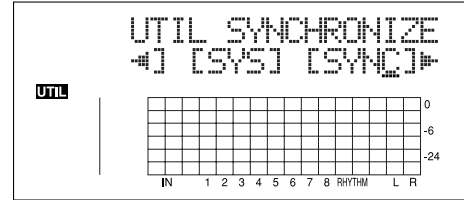

3. Press CURSOR [◀] [▶] to select "MMC Master," and turn the TIME/VALUE dial to set the MMC mode.

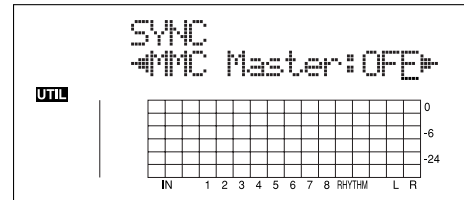

- OFF:** MMC will not be transmitted.
- ON:** MMC information is sent. The BR-900CD becomes the master of the external MIDI instrument.

* For details on the MMC functionality supported by the BR-900CD, read "MIDI Implementation" (p. 216).

4. Press CURSOR [◀] [▶] to select "Sync Gen," and turn the TIME/VALUE dial to set "MTC."

5. Make settings on your sequencer software.

Make the following settings on your sequencer software. For details on making these settings, refer to the manual for your sequencer software.

- MTC:** receive
- MTC type:** same setting as the MTC Type selected on the BR-900CD
- MMC:** receive

6. Press [UTILITY] (or press [EXIT] repeatedly) to return to the Play screen.

* During updating, "Keep power on!" appears in the upper line of the display, while the lower line shows what is being processed.

Section 7

Using USB

Before Using USB (Overview)

The BR-900CD is equipped with a USB connector, which allows you to connect the BR-900CD directly to a computer, making it easy to back up your important song data and exchange files between the BR-900CD and the computer.

What is USB?

USB, short for “Universal Serial Bus,” is a type of interface for connecting computers with a variety of peripheral devices.

Using USB allows you to connect different peripherals using a single USB cable, and also provides rapid data transmission.

What’s more, you can connect and disconnect peripherals with the power on, and the computer can automatically recognize when devices are connected (you may need to make settings when connecting certain devices).

On the BR-900CD, USB is used for the following tasks:

- Backing up the BR-900CD’s data
- Saving BR-900CD track data in WAV/AIFF format (WAV/AIFF Export)
- Loading WAV/AIFF files in BR-900CD tracks (WAV/AIFF Import)
- Importing SMFs and creating patterns
- Loading drum sounds from WAV/AIFF files

NOTE

Realtime audio signals and MIDI messages cannot be handled via the BR-900CD’s USB connector.

Compatible OS

Windows:

Windows Me / 2000 / XP

Macintosh:

Mac OS 9.1.x / 9.2.x

Mac OS X

Driver

The BR-900CD uses a standard DRIVER that is found on OS. The DRIVER will be installed automatically once connected with Computer via USB.

Composition of Data on Memory Cards

The folders and files created are as shown below.

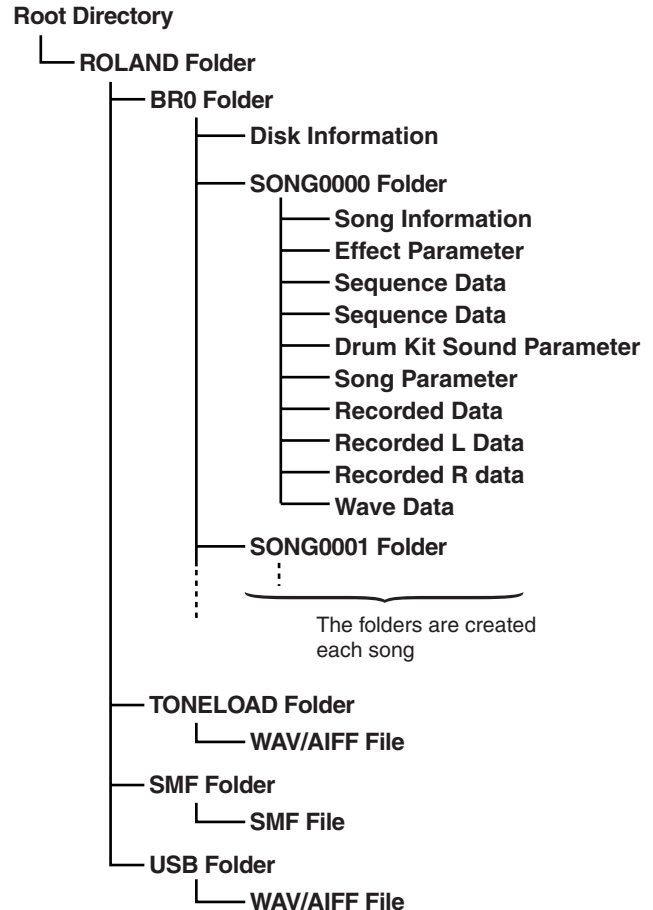

ROLAND Folder

The structure of the files and folders on the BR-900CD is as follows.

BR0 Folder

Song data (recording data, song arrangements/patterns/drum kits, effect song patches, and song information) are saved to each song folder.

TONELOAD Folder

WAV and AIFF files loaded for use as drum sounds will be saved here (p. 171, p. 181).

SMF Folder

SMF files loaded for use in song patterns will be saved here (p. 169, p. 179).

USB Folder

WAV and AIFF files loaded to the BR-900CD's tracks, and WAV and AIFF files saved on computers (track data converted to WAV and AIFF format) will be saved here (p. 165, p. 167, p. 176, p. 178).

Folders and files created on memory cards are displayed on the computer screen.

When you continue with an operation, the "BOSS_BR-900" icon is added in the computer screen.

* With certain versions of Windows OS, the "Removable disk (*:)" icon may be displayed.

(Ex.) Windows XP

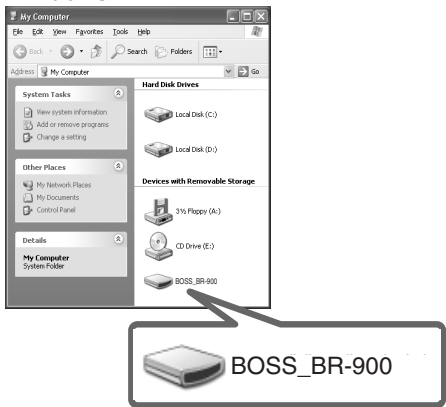

(Ex.) Windows 2000



(Ex.) Macintosh



When you click the "BOSS_BR-900" icon (or the "Removable disk (*:)" icon), or double-click the "BOSS_BR-900" icon on the Macintosh, the "ROLAND" folder is displayed.

Open this folder to show the "BR0" folder, the "TONELOAD" folder, the "SMF" folder, and the "USB" folder.

(Ex.)

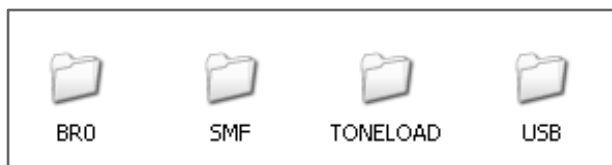

Connecting a Computer

Use the USB cable to connect the BR-900CD to your computer.

* Purchase USB cables at computer stores or other retailers.

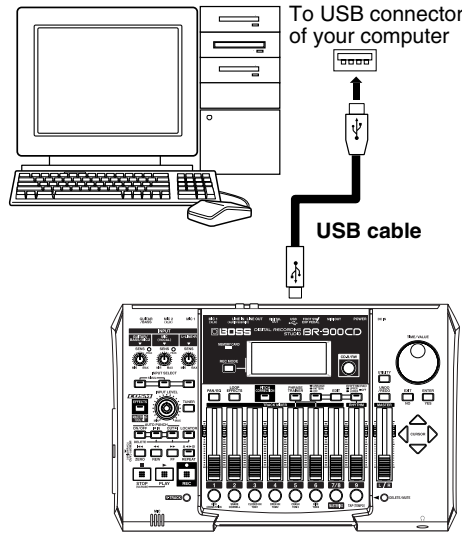

Notes on Using USB

Do not perform the following actions when switching to USB mode or transmitting data. These operations may result in your computer not responding to the data. Data on memory cards may also be corrupted.

Do not:

- Disconnect the USB cable
• Eject the memory card
• Put the computer in suspended (standby) mode or hibernation, restart, or quit
• Turn off the BR-900CD's power

When Using Windows XP/2000

If using Windows XP/2000, log on to Windows as one of the following users:

- Administrator or other user with the privileges of the Administrators group
• A user whose account type is Computer Administrator

Note that you will not be able to properly quit the USB connection if the user name is not one of those described above.

For more details, consult the system administrator for the computer you are using.

With Windows

Backing Up the BR-900CD's Data

1. Connect your computer and the BR-900CD with a USB cable.
2. Confirm that the recorder is stopped, then press [UTILITY].

3. Press CURSOR [◀] [▶] to move the cursor to "USB," and press [ENTER].

The USB screen appears.

4. Select "BACKUP" with the TIME/VALUE dial, then press [ENTER].

The Idling screen appears in the display.

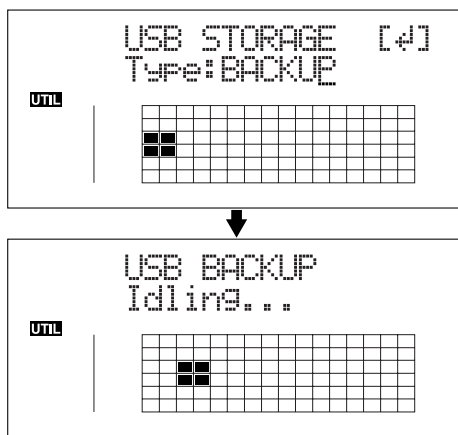

- * You cannot carry out the following procedure unless the Idling screen is displayed. Refer to p. 212 for instructions on resolving this problem.

The "BOSS_BR-900" (or "Removable disk (*:)" icon is added to the computer.



5. Back up the data.

- 1) Click the "BOSS_BR-900" (or "Removable disk (*:)" icon.
- 2) Drag the "ROLAND" folder to the computer's folder and drop it in the folder.

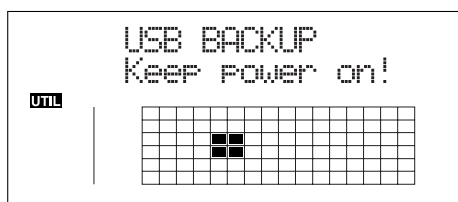

When you have finished backing up the data, the Idling screen returns to the display.

HINT

Reading backup data back into the BR-900CD from PC (Recover)

When restoring data backed up on a computer to the BR-900CD, drag the "ROLAND" folder to the "BOSS_BR-900" icon (or the "Removable disk (*:)" icon) and drop it there (overwriting it).

6. Quit the connection to the computer.

With Windows XP

In My Computer, right-click on the "BOSS_BR-900" icon (or "Removable disk (*:)" icon) to "Eject" the disk.

- * If this procedure fails to eject the disk, use the procedure below.

- 1) Click the  icon in the task tray, then click the "Stop USB Disk—drive (*:)" message displayed there.

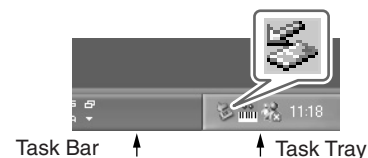

- 2) Click [OK] in the "Safe To Remove Hardware" dialog box that appears.

With Windows 2000/Me

- 1) In My Computer, right-click on the "BOSS_BR-900" icon (or "Removable disk (*:)" icon) to "Eject" the disk.
- 2) Click the  icon in the task tray, then click the "Stop USB Disk—drive (*:)" message displayed there.

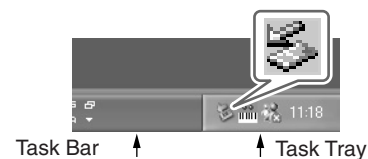

- 3) Click [OK] in the "Safe To Remove Hardware" dialog box that appears.

7. Press the BR-900CD's [EXIT].

The USB screen returns to the display.

* If you press [EXIT] without quitting the connection to the computer, the following screens appear. In this case, pressing [ENTER] returns the USB screen to the display.

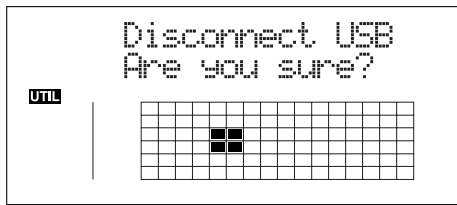

8. When backup of the data is complete, press [EXIT] to return to the Play screen.

At this point, you can safely disconnect the USB cable from the BR-900CD and the computer.

Saving BR-900CD Track Data in WAV/AIFF Format (WAV/AIFF Export)

You can convert the BR-900CD's track data into WAV or AIFF files and save these on your computer. After converting your mastered tracks to WAV or AIFF files, you can easily use your computer to create audio CDs with the data, as well as load the data into audio applications.

Resolving insufficient memory issues when exporting WAV/AIFF

When exporting WAV or AIFF files, memory cards must have enough free space to hold the files. If too little memory is available and the "Card Full!" error message appears, there are two approaches you can take to overcome the problem.

Deleting unneeded data from the memory card

1. Back up the data on the card (see p. 164).
2. Erase unneeded songs (see p. 77).
3. Also erase track data other than that for the tracks you want to export (see p. 73).
4. Export the data.
5. Restore the backed up data to the BR-900CD (see the Step 5 "HINT" on p. 164).

Using a high-capacity memory card

For more on supported memory cards (CompactFlash) for the BR-900CD, refer to the separate sheet "About Memory Cards."

1. Connect your computer and the BR-900CD with a USB cable.
2. Confirm that the recorder is stopped, then press [UTILITY].
3. Press CURSOR [◀] [▶] to move the cursor to "USB," and press [ENTER].
The USB screen appears.
4. Select "EXPORT" with the TIME/VALUE dial, then press [ENTER].

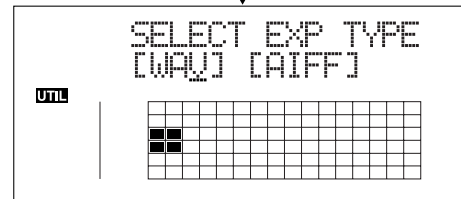
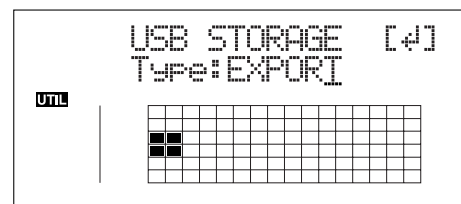

5. Press CURSOR [◀] [▶] to select the file format, then press [ENTER].
WAV: This is an audio format used primarily with Windows.
AIFF: This audio format is used primarily with Macintosh.
6. Use CURSOR [◀] [▶] and the TIME/VALUE dial to select the track/V-track to be saved.

When saving in mono

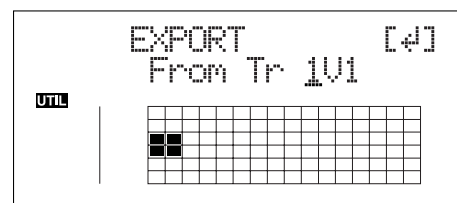

When saving in stereo

* Select the track combination 1/2, 3/4, 5/6, or 7/8.

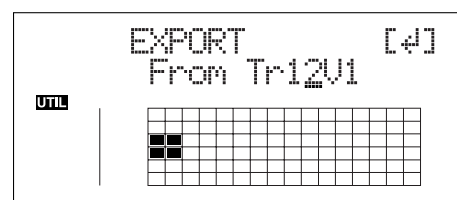

7. Press [ENTER].

Conversion of the WAV or AIFF file begins.

Files names are converted as shown below.

(Mono)	(Stereo)
Track 1, V-Track 1 TR01___1.WAV or TR01___1.AIF	Track 1/2, V-Track 1 TR0102_1.WAV or TR0102_1.AIF
Track 1, V-Track 2 TR01___2.WAV or TR01___2.AIF :	Track 1/2, V-Track 2 TR0102_2.WAV or TR0102_2.AIF :
Track 6, V-Track 7 TR06___7.WAV or TR06___7.AIF	Track 7/8, V-Track 7 TR0708_7.WAV or TR0708_7.AIF
Track 6, V-Track 8 TR06___8.WAV or TR06___8.AIF	Track 7/8, V-Track 8 TR0708_8.WAV or TR0708_8.AIF

* Converting songs takes approximately the same amount of time (twice as long in stereo) to complete as it does to play the source song data.

When the conversion is complete, the "BOSS_BR-900" (or "Removable disk (*:)" icon is added to the computer.



8. Export the WAV or AIFF file to the computer.

- 1) Click the "BOSS_BR-900" (or "Removable disk (*:)" icon.
- 2) Drag the WAV or AIFF file in the "USB" folder in the "ROLAND" folder to the computer's folder and drop it in the folder.

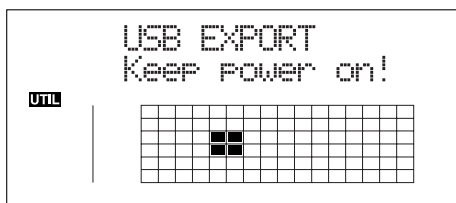

When you have finished exporting the data, the Idling screen returns to the display.

9. Quit the connection to the computer.

With Windows XP

In My Computer, right-click on the "BOSS_BR-900" icon (or "Removable disk (*:)" icon) to "Eject" the disk.

* If this procedure fails to eject the disk, use the procedure below.

- 1) Click the  icon in the task tray, then click the "Stop USB Disk—drive (*:)" message displayed there.

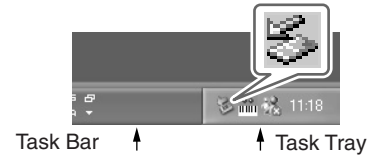

- 2) Click [OK] in the "Safe To Remove Hardware" dialog box that appears.

With Windows 2000/Me

- 1) In My Computer, right-click on the "BOSS_BR-900" icon (or "Removable disk (*:)" icon) to "Eject" the disk.
- 2) Click the  icon in the task tray, then click the "Stop USB Disk—drive (*:)" message displayed there.

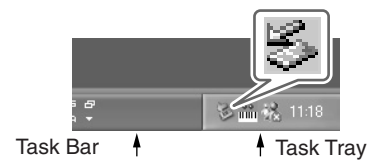

- 3) Click [OK] in the "Safe To Remove Hardware" dialog box that appears.

10. Press the BR-900CD's [EXIT].

The file format selection screen returns to the display.

The contents of the "USB" folder are automatically deleted the instant the [EXIT] button is pressed.

* If you press [EXIT] without quitting the connection to the computer, the following screens appear. In this case, pressing [ENTER] returns the file format selection screen to the display.

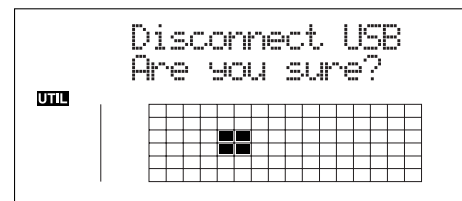

At this point, you can safely disconnect the USB cable from the BR-900CD and the computer.

11. Repeat Steps 4–9 as needed.

12. When you have finished exporting the WAV or AIFF file(s), press [EXIT] several times to return to the Play screen.

Loading WAV/AIFF Files in BR-900CD Tracks (WAV/AIFF Import)

You can take WAV or AIFF files on your computer, such as files created with audio software applications, and load them to the BR-900CD's tracks.

NOTE

- Wave data in the following formats can be imported. You cannot import wave data in other formats.
 - WAV or AIFF format
 - Mono or Stereo
 - 8-bit or 16-bit
 - Sampling Rate: 44.1 kHz
- Add the extension "WAV" to imported WAV files and the extension "AIF" to imported AIFF files.
- Compressed WAV files or AIFF files cannot be loaded.
- Extremely short waveform data (less than approximately 1 sec) cannot be loaded.
- The loop point settings within an AIFF file will be ignored.
- If the unit is in the Arrange mode at the time of the import, it takes place in accord with the timing of the Arrange mode. On the other hand, if the unit is in the Pattern mode at the time of the import, it takes place in accord with the timing of the Pattern mode.

1. Connect your computer and the BR-900CD with a USB cable.
2. Confirm that the recorder is stopped, then press [UTILITY].
3. Press CURSOR [◀] [▶] to move the cursor to "USB," and press [ENTER].
The USB screen appears.
4. Select "IMPORT" with the TIME/VALUE dial, then press [ENTER].

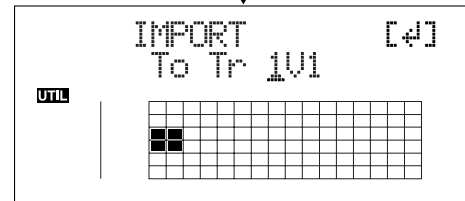
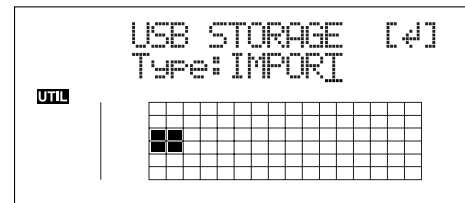

5. Use CURSOR [◀] [▶] and the TIME/VALUE dial to select the track and V-track to be loaded, then press [ENTER].

When loading to the tracks in mono

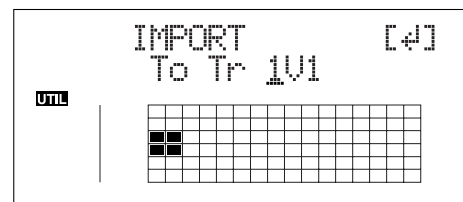

When loading to the tracks in stereo

- * Select the track combination 1/2, 3/4, 5/6, or 7/8.

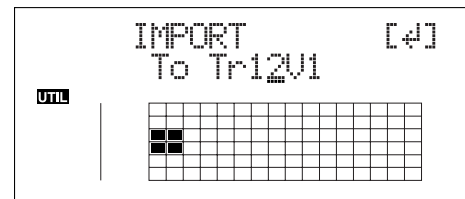

6. Use [CURSOR] and the TIME/VALUE dial to specify the measure or position in the track from which loading is to start, then press [ENTER].

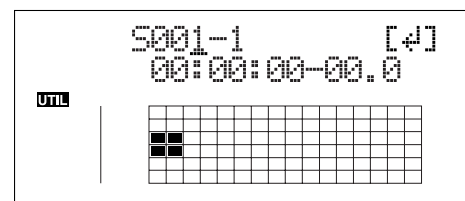

The "BOSS_BR-900" (or "Removable disk (*:)" icon is added to the computer.



7. Copy the WAV or AIFF files you want to import.
 - 1) Click the "BOSS_BR-900" (or "Removable disk (*:)" icon.
 - 2) Drag the imported WAV or AIFF file to the "USB" folder in the "ROLAND" folder.
- * Only one file can be imported at a time in each import operation. Do not drag and drop more than one file at a time.

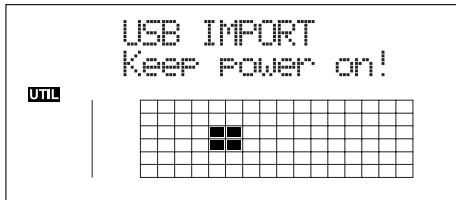

When you have finished Copying the data, the Idling screen returns to the display.

8. Quit the connection to the computer.

With Windows XP

In My Computer, right-click on the "BOSS_BR-900" icon (or "Removable disk (*:)" icon) to "Eject" the disk.

* If this procedure fails to eject the disk, use the procedure below.

- 1) Click the  icon in the task tray, then click the "Stop USB Disk—drive (*:)" message displayed there.

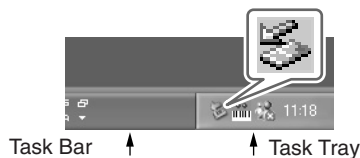

- 2) Click [OK] in the "Safe To Remove Hardware" dialog box that appears.

With Windows 2000/Me

- 1) In My Computer, right-click on the "BOSS_BR-900" icon (or "Removable disk (*:)" icon) to "Eject" the disk.
- 2) Click the  icon in the task tray, then click the "Stop USB Disk—drive (*:)" message displayed there.

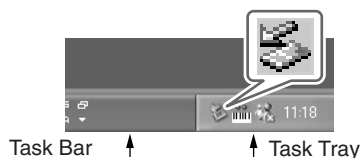

- 3) Click [OK] in the "Safe To Remove Hardware" dialog box that appears.

9. Press the BR-900CD's [EXIT].

The WAV or AIFF file is imported.

The contents of the "USB" folder are automatically deleted at the time the import is finished.

* If you press [EXIT] without quitting the connection to the computer, the following screens appear. In this case, pressing [ENTER] imports the WAV or AIFF file.

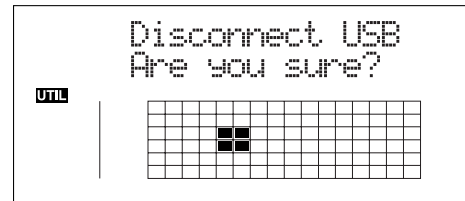

Once the import is complete, you are returned to the screen for specifying the import-source track/V-Track.

At this point, you can safely disconnect the USB cable from the BR-900CD and the computer.

10. Repeat Steps 4–8 as needed.

11. When you have finished importing the WAV or AIFF file(s), press [EXIT] repeatedly to return to the Play screen.

Importing SMFs and Creating Patterns

You can import SMFs (Standard MIDI Files) stored on memory cards as song patterns. You can easily increase your collection of song patterns by creating SMFs on your computer or other device and copying them to memory cards.

NOTE

- You cannot import SMFs containing more than 999 measures.
- Add the extension "MID" to SMFs you are importing.
- Use file names containing eight alphanumeric characters.

1. Connect your computer and the BR-900CD with a USB cable.
2. Confirm that the recorder is stopped, then press [UTILITY].

3. Press CURSOR [<] [>] to move the cursor to "USB," and press [ENTER].

The USB screen appears.

4. Select "BACKUP" with the TIME/VALUE dial, then press [ENTER].

The Idling screen appears in the display.

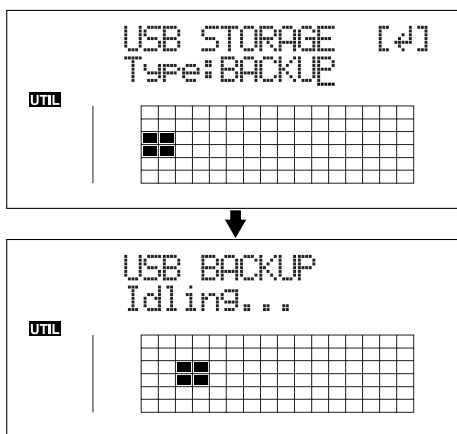

* You cannot carry out the following procedure unless the Idling screen is displayed. Refer to p. 212 for instructions on resolving this problem.

The "BOSS_BR-900" (or "Removable disk (*:)" icon is added to the computer.



5. Import the SMF.
 - 1) Click the "BOSS_BR-900" (or "Removable disk (*:)" icon.
 - 2) Drag the imported SMF to the "SMF" folder in the "ROLAND" folder.

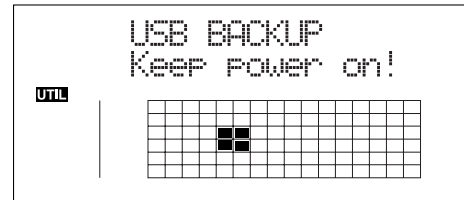

When you have finished importing the SMF, the Idling screen returns to the display.

6. Quit the connection to the computer.

With Windows XP

In My Computer, right-click on the "BOSS_BR-900" icon (or "Removable disk (*:)" icon) to "Eject" the disk.

* If this procedure fails to eject the disk, use the procedure below.

- 1) Click the icon in the task tray, then click the "Stop USB Disk—drive (*:)" message displayed there.

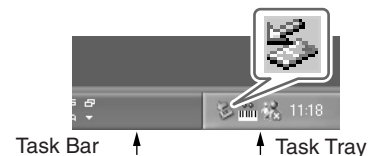

- 2) Click [OK] in the "Safe To Remove Hardware" dialog box that appears.

With Windows 2000/Me

- 1) In My Computer, right-click on the "BOSS_BR-900" icon (or "Removable disk (*:)" icon) to "Eject" the disk.
- 2) Click the icon in the task tray, then click the "Stop USB Disk—drive (*:)" message displayed there.

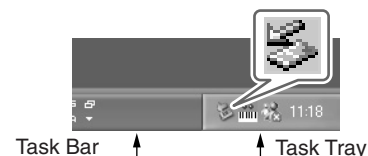

- 3) Click [OK] in the "Safe To Remove Hardware" dialog box that appears.

7. Press BR-900CD's [EXIT] repeatedly to return to the Play screen.

* If you press [EXIT] without quitting the connection to the computer, the following screens appear. In this case, pressing [ENTER] and then [EXIT] returns the Play screen to the display.

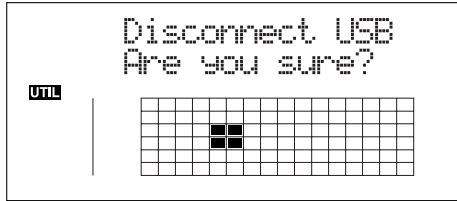

At this point, you can safely disconnect the USB cable from the BR-900CD and the computer.

8. Press [ARRANGE/PATTERN/OFF] repeatedly until the indicator is flashing.

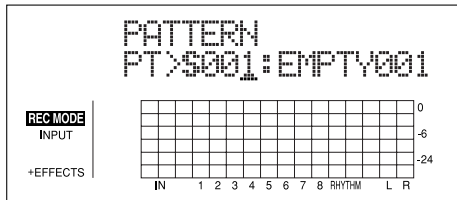

9. Press [EDIT].

10. Press [CURSOR] to move the cursor to "SMF," and press [ENTER].

The names of the SMFs on the memory card are displayed.

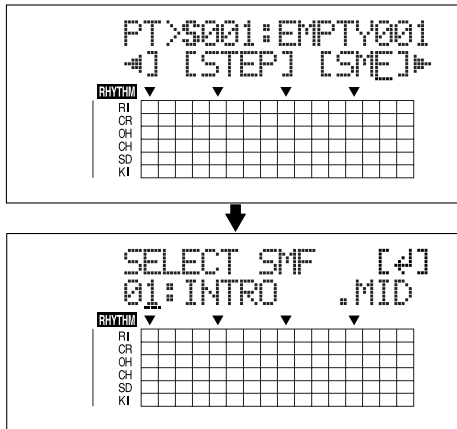

11. Turn the TIME/VALUE dial to select the SMF to be imported, then press [ENTER].

MEMO

When importing GM/GS/XG-compatible SMFs, MIDI Channel 10 is generally assigned as the channel used for rhythm performances. Thus, only the data on MIDI Channel 10 in the SMF is isolated and imported by the BR-900CD. Note that the data on other channels is disregarded.

12. Turn the TIME/VALUE dial to select the import-destination song pattern, then press [ENTER].

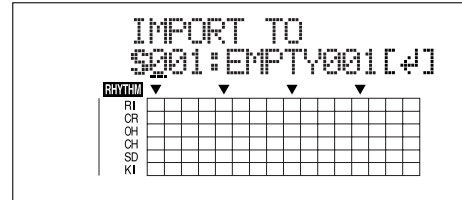

The import is executed.

- * With some SMF files, a considerable amount of time may be required to finish importing the file.
- * During updating, "Keep power on!" appears in the upper line of the display, while the lower line shows what is being processed.

Loading Drum Sounds from WAV/AIFF Files (Tone Load)

You can import WAV and AIFF files on your computer and load these as drum sounds (TONE LOAD).

NOTE

- The Rhythm and Tone Load functions cannot be used when tracks are bounced directly to a CD (p. 59).
- Wave data in the following formats can be imported. You cannot import wave data in other formats.
 - WAV or AIFF format
 - Mono or Stereo
 - 8-bit or 16-bit
 - Sampling Rate: 44.1 kHz
- Compressed WAV files or AIFF files cannot be loaded.
- Extremely short waveform data (less than approximately 100 msec) cannot be loaded.
- The loop point settings within an AIFF file will be ignored.
- Add the extension "WAV" to imported WAV files and the extension "AIF" to imported AIFF files.
- You can load drum sounds of up to 13 seconds for a single drum kit.

(Example)

Kick: 3 seconds, snare: 3 seconds, crash cymbal: 7 seconds → Total 13 seconds
- Stereo WAV and AIFF files are loaded as "mono" sounds with the left and right sides mixed.

1. Connect your computer and the BR-900CD with a USB cable.
2. Confirm that the recorder is stopped, then press [UTILITY].
3. Press CURSOR [◀] [▶] to move the cursor to "USB," and press [ENTER].
The USB screen appears.
4. Select "BACKUP" with the TIME/VALUE dial, then press [ENTER].
The Idling screen appears in the display.

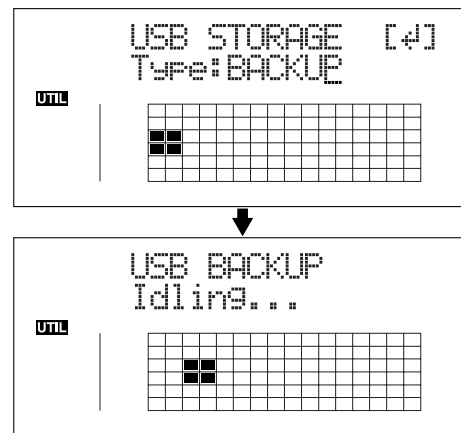

* You cannot carry out the following procedure unless the Idling screen is displayed. Refer to p. 212 for instructions on resolving this problem.

The "BOSS_BR-900" (or "Removable disk (*:)" icon is added to the computer.



5. Import the WAV or AIFF file.
 - 1) Click the "BOSS_BR-900" (or "Removable disk (*:)" icon.
 - 2) Drag the imported WAV or AIFF file to the "TONELOAD" folder in the "ROLAND" folder.

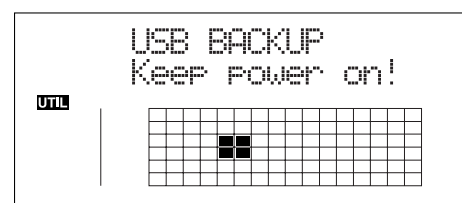

When you have finished importing the WAV or AIFF files, the Idling screen returns to the display.

6. Quit the connection to the computer.

With Windows XP

In My Computer, right-click on the "BOSS_BR-900" icon (or "Removable disk (*:)" icon) to "Eject" the disk.

- * If this procedure fails to eject the disk, use the procedure below.
- 1) Click the  icon in the task tray, then click the "Stop USB Disk—drive (*:)" message displayed there.

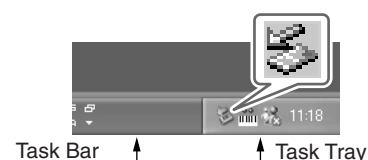

- Click [OK] in the "Safe To Remove Hardware" dialog box that appears.

With Windows 2000/Me

- In My Computer, right-click on the "BOSS_BR-900" icon (or "Removable disk (*)" icon) to "Eject" the disk.
- Click the  icon in the task tray, then click the "Stop USB Disk—drive (*)" message displayed there.

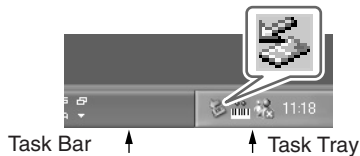

- Click [OK] in the "Safe To Remove Hardware" dialog box that appears.

- Press BR-900CD's [EXIT] repeatedly to return to the Play screen.

- If you press [EXIT] without quitting the connection to the computer, the following screens appear. In this case, pressing [ENTER] and then [EXIT] returns the Play screen to the display.

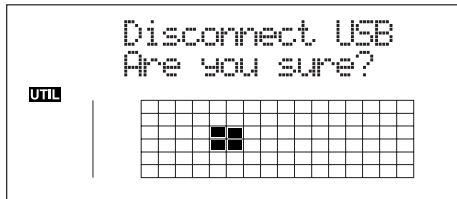

At this point, you can safely disconnect the USB cable from the BR-900CD and the computer.

- Press [UTILITY].
- Press CURSOR [◀] [▶] to move the cursor to "TONE," and press [ENTER].

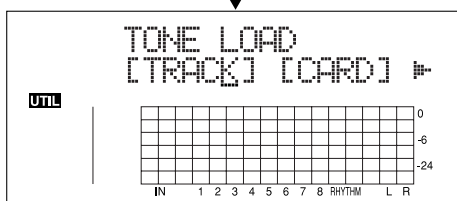
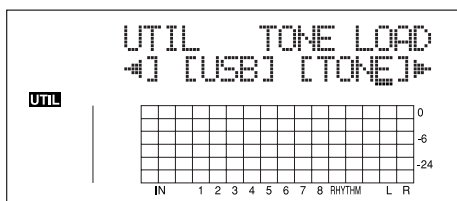

- Press CURSOR [◀] [▶] to move the cursor to "CARD," and press [ENTER].

The names of the WAV and AIFF files on the memory card are displayed.

- WAV files are indicated by the symbol ".W"; ".A" indicates AIFF files.

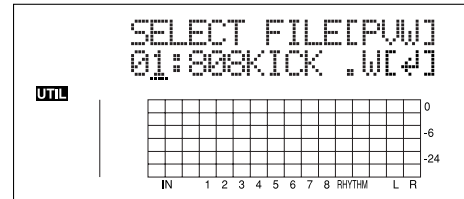

- Turn the TIME/VALUE dial to select the WAV or AIFF file with the drum sound to be loaded.

MEMO

You can preview the sound of the WAV or AIFF file to be loaded by moving the cursor to "PVW" and pressing [ENTER].

- Turn the TIME/VALUE dial to specify the load-destination song drum kit.

S1-5: Song Drum Kit 1-5

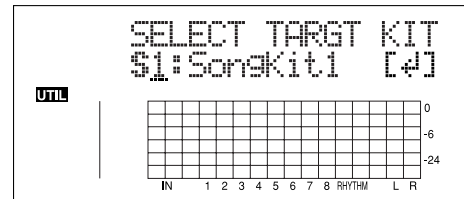

- Turn the TIME/VALUE dial to select the load-destination song drum sound, then press [ENTER].

The load is executed.

To cancel, press [EXIT].

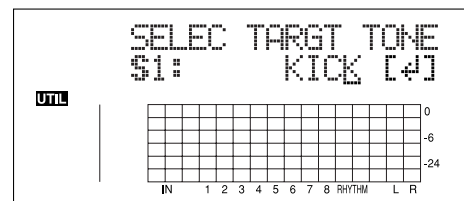

- During updating, "Keep power on!" appears in the upper line of the display, while the lower line shows what is being processed.

- WAV and AIFF files in the TONELOAD folder are retained without being deleted even after this procedure is completed. If these files are no longer needed, connect the BR-900CD to your computer via USB and use the computer to delete the files. Any files that are retained will use the required amount of memory on the memory card.

Using the BR-864 / BR-532's Data

You can use the BR-900CD to play BR-864 (or BR-532) data.

* First be sure to back up the BR-864 / BR-532's "ROLAND" folder to the computer.

1. Initializing the memory card on the BR-900CD (p. 196).
2. Connect your computer and the BR-900CD with a USB cable.
3. Confirm that the recorder is stopped, then press [UTILITY].
4. Press CURSOR [◀] [▶] to move the cursor to "USB," and press [ENTER].
5. Select "BACKUP" with the TIME/VALUE dial, then press [ENTER].

The USB screen appears.

The Idling screen appears in the display.

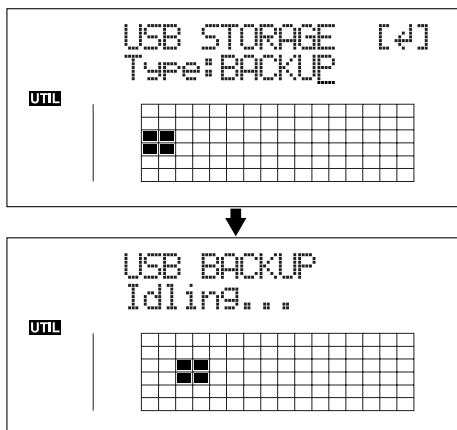

* You cannot carry out the following procedure unless the Idling screen is displayed. Refer to p. 212 for instructions on resolving this problem.

The "BOSS_BR-900" (or "Removable disk (*:)" icon) is added to the computer.



6. Delete the BR-900CD "ROLAND" folder.
 - 1) Click the "BOSS_BR-900" (or "Removable disk (*:)" icon, and delete the "ROLAND" folder.

7. Drag the previously backed up BR-864 / BR-532 "ROLAND" folder to the "BOSS_BR-900" (or "Removable disk (*:)" icon and drop it there.

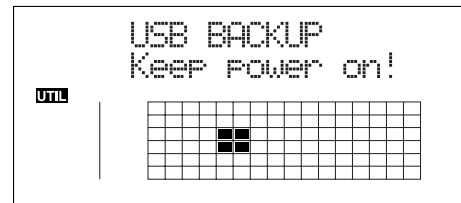

When you have finished backing up the data, the Idling screen returns to the display.

8. Quit the connection to the computer.

With Windows XP

In My Computer, right-click on the "BOSS_BR-900" icon (or "Removable disk (*:)" icon) to "Eject" the disk.

* If this procedure fails to eject the disk, use the procedure below.

- 1) Click the icon in the task tray, then click the "Stop USB Disk—drive (*:)" message displayed there.

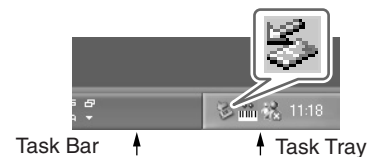

- 2) Click [OK] in the "Safe To Remove Hardware" dialog box that appears.

With Windows 2000/Me

- 1) In My Computer, right-click on the "BOSS_BR-900" icon (or "Removable disk (*:)" icon) to "Eject" the disk.
- 2) Click the icon in the task tray, then click the "Stop USB Disk—drive (*:)" message displayed there.

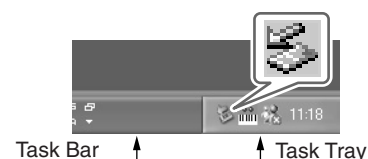

- 3) Click [OK] in the "Safe To Remove Hardware" dialog box that appears.

9. Press the BR-900CD's [EXIT].

The USB screen returns to the display.

- * *If you press [EXIT] without quitting the connection to the computer, the following screens appear. In this case, pressing [ENTER] returns the USB screen to the display.*

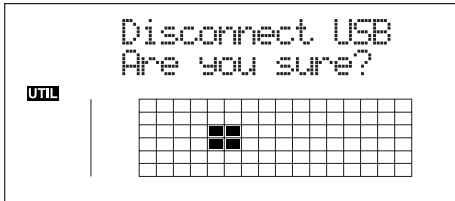

10. When backup of the data is complete, press [EXIT] to return to the Play screen.

At this point, you can safely disconnect the USB cable from the BR-900CD and the computer.

With Macintosh

Backing Up the BR-900CD's Data

1. Connect your computer and the BR-900CD with a USB cable.
2. Confirm that the recorder is stopped, then press [UTILITY].
3. Press CURSOR [◀] [▶] to move the cursor to "USB," and press [ENTER].
The USB screen appears.
4. Select "BACKUP" with the TIME/VALUE dial, then press [ENTER].
The Idling screen appears in the display.

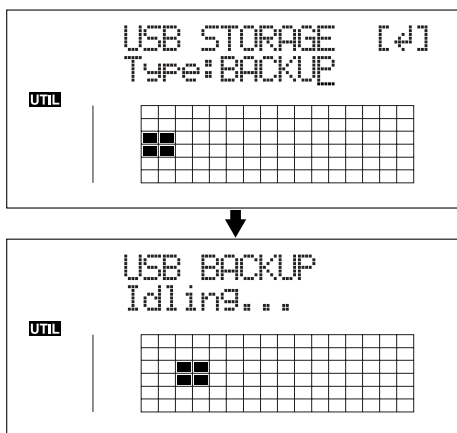

* You cannot carry out the following procedure unless the Idling screen is displayed. Refer to p. 212 for instructions on resolving this problem.

The "BOSS_BR-900" icon is added to the computer.

(Ex.)



5. Back up the data.
 - 1) Double-click the "BOSS_BR-900" icon.
 - 2) Drag the "ROLAND" folder to the computer's folder and drop it in the folder.

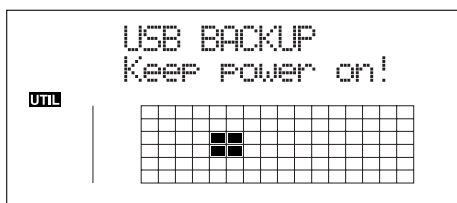

When you have finished backing up the data, the Idling screen returns to the display.

HINT

Reading backup data back into the BR-900CD from PC (Recover)

When restoring data backed up on a computer to the BR-900CD, drag the "ROLAND" folder to the "BOSS_BR-900" icon and drop it there (overwriting it).

6. Quit the connection to the computer.
 - 1) Drag the "BOSS_BR-900" icon into the trash.
7. Press the BR-900CD's [EXIT].
The USB screen returns to the display.
 - * If you press [EXIT] without quitting the connection to the computer, the following screens appear. In this case, pressing [ENTER] returns the USB screen to the display.

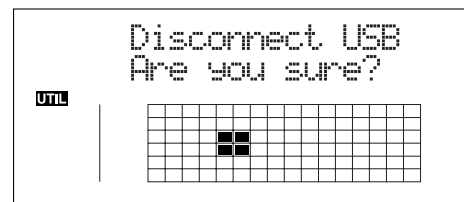

8. When backup of the data is complete, press [EXIT] to return to the Play screen.

At this point, you can safely disconnect the USB cable from the BR-900CD and the computer.

Saving BR-900CD Track Data in WAV/AIFF Format (WAV/AIFF Export)

You can convert the BR-900CD's track data into WAV or AIFF files and save these on your computer. After converting your mastered tracks to WAV or AIFF files, you can easily use your computer to create audio CDs with the data, as well as load the data into audio applications.

Resolving insufficient memory issues When exporting WAV/AIFF

When exporting WAV or AIFF files, memory cards must have enough free space to hold the files. If too little memory is available and the "Card Full!" error message appears, there are two approaches you can take to overcome the problem.

Deleting unneeded data from the memory card

1. Back up the data on the card (see p. 175).
2. Erase unneeded songs (see p. 77).
3. Also erase track data other than that for the tracks you want to export (see p. 73).
4. Export the data.
5. Restore the backed up data to the BR-900CD (see the Step 5 "HINT" on p. 175).

Using a high-capacity memory card

For more on supported memory cards (CompactFlash) for the BR-900CD, refer to the separate sheet "About Memory Cards."

1. Connect your computer and the BR-900CD with a USB cable.
2. Confirm that the recorder is stopped, then press [UTILITY].
3. Press CURSOR [◀] [▶] to move the cursor to "USB," and press [ENTER].
The USB screen appears.
4. Select "EXPORT" with the TIME/VALUE dial, then press [ENTER].

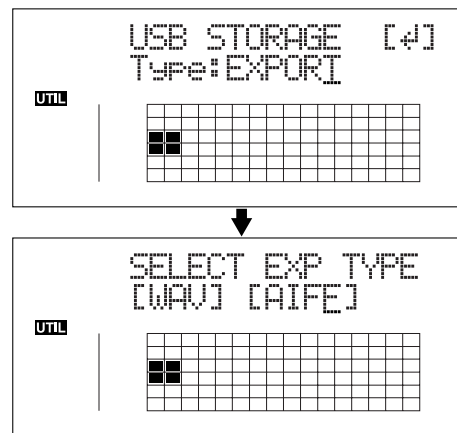

5. Press CURSOR [◀] [▶] to select the file format, then press [ENTER].
WAV: This is an audio format used primarily with Windows.
AIFF: This audio format is used primarily with Macintosh.
6. Turn the TIME/VALUE dial to select the track/V-Track to be saved.

When saving in mono

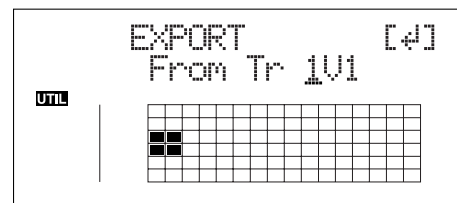

When saving in stereo

- * Select the track combination 1/2, 3/4, 5/6, or 7/8.

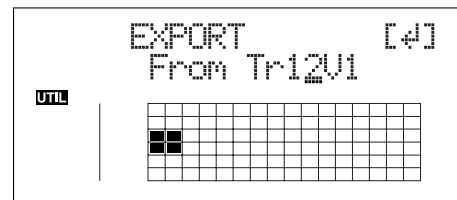

7. Press [ENTER].

Conversion of the WAV or AIFF file begins.

Files names are converted as shown below.

(Mono)	(Stereo)
Track 1, V-Track 1 TR01__1.WAV or TR01__1.AIF	Track 1/2, V-Track 1 TR0102_1.WAV or TR0102_1.AIF
Track 1, V-Track 2 TR01__2.WAV or TR01__2.AIF :	Track 1/2, V-Track 2 TR0102_2.WAV or TR0102_2.AIF :
Track 6, V-Track 7 TR06__7.WAV or TR06__7.AIF	Track 7/8, V-Track 7 TR0708_7.WAV or TR0708_7.AIF
Track 6, V-Track 8 TR06__8.WAV or TR06__8.AIF	Track 7/8, V-Track 8 TR0708_8.WAV or TR0708_8.AIF

* Converting songs takes approximately the same amount of time (twice as long in stereo) to complete as it does to play the source song data.

When the conversion is complete, the "BOSS_BR-900" icon is added to the computer.

(Ex.)



8. Export the WAV or AIFF file to the computer.

- 1) Double-click the "BOSS_BR-900" icon.
- 2) Drag the WAV or AIFF file in the "USB" folder in the "ROLAND" folder to the computer's folder and drop it in the folder.

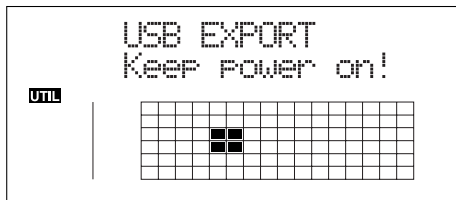

When you have finished exporting the data, the Idling screen returns to the display.

9. Quit the connection to the computer.

- 1) Drag the "BOSS_BR-900" icon into the trash.

10. Press the BR-900CD's [EXIT].

The file format selection screen returns to the display.

The contents of the "USB" folder are automatically deleted the instant the [EXIT] button is pressed.

* If you press [EXIT] without quitting the connection to the computer, the following screens appear. In this case, pressing [ENTER] returns the file format selection screen to the display.

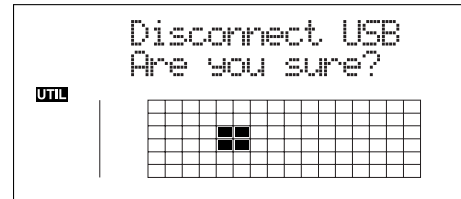

At this point, you can safely disconnect the USB cable from the BR-900CD and the computer.

11. Repeat Steps 4–9 as needed.

12. When you have finished exporting the WAV or AIFF file(s), press [EXIT] several times to return to the Play screen.

Loading WAV/AIFF Files in BR-900CD Tracks (WAV/AIFF Import)

You can take WAV or AIFF files on your computer, such as files created with audio software applications, and load them to the BR-900CD's tracks.

NOTE

- Wave data in the following formats can be imported. You cannot import wave data in other formats.
 - WAV or AIFF format
 - Mono or Stereo
 - 8-bit or 16-bit
 - Sampling Rate: 44.1 kHz
- Add the extension "WAV" to imported WAV files and the extension "AIF" to imported AIFF files.
- Compressed WAV files or AIFF files cannot be loaded.
- Extremely short waveform data (less than approximately 1 sec) cannot be loaded.
- The loop point settings within an AIFF file will be ignored.
- If the unit is in the Arrange mode at the time of the import, it takes place in accord with the timing of the Arrange mode. On the other hand, if the unit is in the Pattern mode at the time of the import, it takes place in accord with the timing of the Pattern mode.

1. Connect your computer and the BR-900CD with a USB cable.
2. Confirm that the recorder is stopped, then press [UTILITY].
3. Press CURSOR [◀] [▶] to move the cursor to "USB," and press [ENTER].
The USB screen appears.
4. Select "IMPORT" with the TIME/VALUE dial, then press [ENTER].

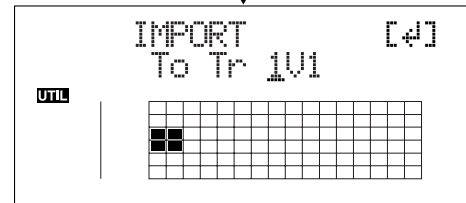
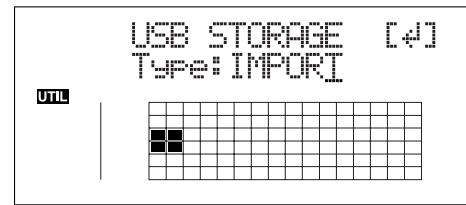

5. Use CURSOR [◀] [▶] and the TIME/VALUE dial to select the track/V-Track to be loaded, then press [ENTER].

When loading to the tracks in mono

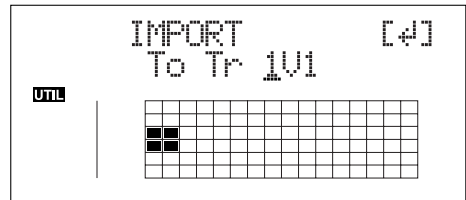

When loading to the tracks in stereo

- * Select the track combination 1/2, 3/4, 5/6, or 7/8.

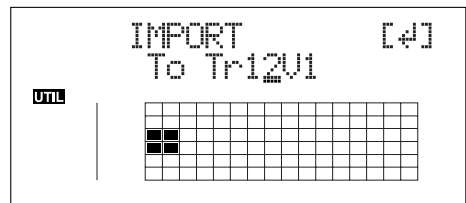

6. Use [CURSOR] and the TIME/VALUE dial to specify the measure or position in the track from which loading is to start, then press [ENTER].

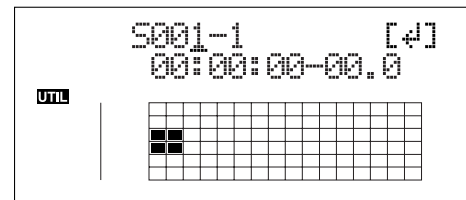

The "BOSS_BR-900" icon is added to the computer.

(Ex.)

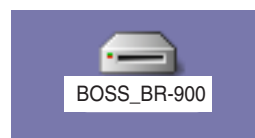

7. Copy the WAV or AIFF files you want to import.
 - 1) Double-click the "BOSS_BR-900" icon.
 - 2) Drag the imported WAV or AIFF file to the "USB" folder in the "ROLAND" folder.
- * Only one file can be imported at a time in each import operation. Do not drag and drop more than one file at a time.

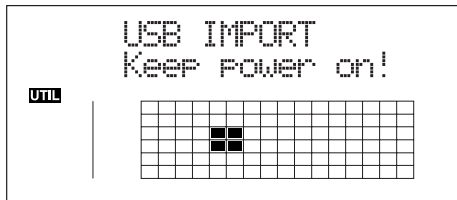

When you have finished copying the data, the Idling screen returns to the display.

8. Quit the connection to the computer.
 - 1) Drag the "BOSS_BR-900" icon into the trash.
 9. Press the BR-900CD's [EXIT].

The WAV or AIFF file is imported.

The contents of the "USB" folder are automatically deleted at the time the import is finished.
- * If you press [EXIT] without quitting the connection to the computer, the following screens appear. In this case, pressing [ENTER] imports the WAV or AIFF file.

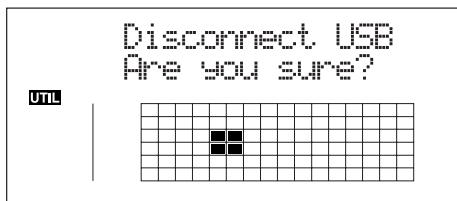

Once the import is complete, you are returned to the screen for specifying the import-source track/V-Track.

At this point, you can safely disconnect the USB cable from the BR-900CD and the computer.

10. Repeat Steps 4–8 as needed.
11. When you have finished importing the WAV or AIFF file(s), press [EXIT] repeatedly to return to the Play screen.

Importing SMFs and Creating Patterns

You can import SMFs (Standard MIDI Files) stored on memory cards as song patterns. You can easily increase your collection of song patterns by creating SMFs on your computer or other device and copying them to memory cards.

NOTE

- You cannot import SMFs containing more than 999 measures.
- Add the extension "MID" to SMFs you are importing.
- Use file names containing eight alphanumeric characters.

1. Connect your computer and the BR-900CD with a USB cable.
2. Confirm that the recorder is stopped, then press [UTILITY].
3. Press CURSOR [◀] [▶] to move the cursor to "USB," and press [ENTER].

The USB screen appears.
4. Select "BACKUP" with the TIME/VALUE dial, then press [ENTER].

The Idling screen appears in the display.

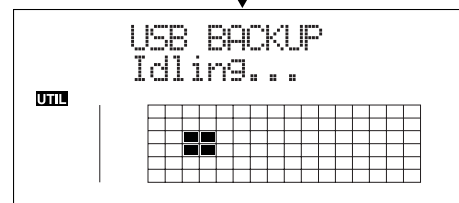
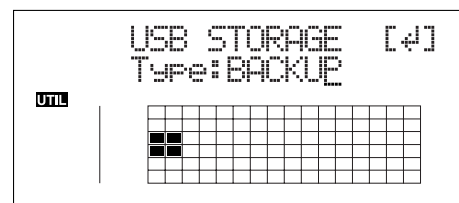

* You cannot carry out the following procedure unless the Idling screen is displayed. Refer to p. 212 for instructions on resolving this problem.

The "BOSS_BR-900" icon is added to the computer.

(Ex.)

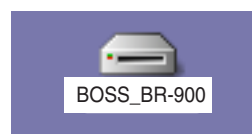

5. Import the SMF.

- 1) Double-click the "BOSS_BR-900" icon.
- 2) Drag the imported SMF to the "SMF" folder in the "ROLAND" folder.

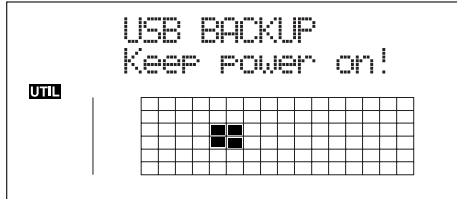

When you have finished importing the SMF, the Idling screen returns to the display.

6. Quit the connection to the computer.

- 1) Drag the "BOSS_BR-900" icon into the trash.

7. Press BR-900CD's [EXIT] repeatedly to return to the Play screen.

- * If you press [EXIT] without quitting the connection to the computer, the following screens appear. In this case, pressing [ENTER] and then [EXIT] returns the Play screen to the display.

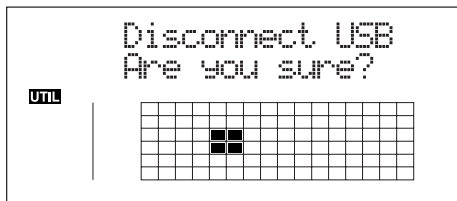

At this point, you can safely disconnect the USB cable from the BR-900CD and the computer.

8. Press [ARRANGE/PATTERN/OFF] repeatedly until the indicator is flashing.

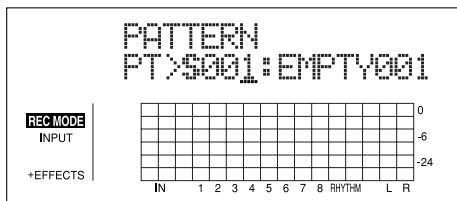

9. Press [EDIT].

10. Press [CURSOR] to move the cursor to "SMF," and press [ENTER].

The names of the SMFs on the memory card are displayed.

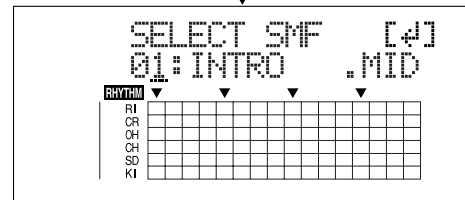
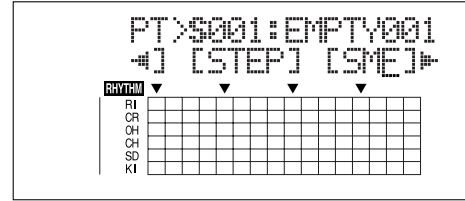

11. Turn the TIME/VALUE dial to select the SMF to be imported, then press [ENTER].

MEMO

When importing GM/GS/XG-compatible SMFs, MIDI Channel 10 is generally assigned as the channel used for rhythm performances. Thus, only the data on MIDI Channel 10 in the SMF is isolated and imported by the BR-900CD. Note that the data on other channels is disregarded.

12. Turn the TIME/VALUE dial to select the import-destination song pattern, then press [ENTER].

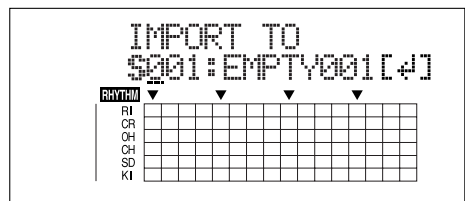

The import is executed.

- * With some SMF files, a considerable amount of time may be required to finish importing the file.
- * During updating, "Keep power on!" appears in the upper line of the display, while the lower line shows what is being processed.

Loading Drum Sounds from WAV/AIFF Files (Tone Load)

You can import WAV and AIFF files on your computer and load these as drum sounds (TONE LOAD).

NOTE

- The Rhythm and Tone Load functions cannot be used when tracks are bounced directly to a CD (p. 59).
 - Wave data in the following formats can be imported. You cannot import wave data in other formats.
 - WAV or AIFF format
 - Mono or Stereo
 - 8-bit or 16-bit
 - Sampling Rate: 44.1 kHz
 - Compressed WAV files or AIFF files cannot be loaded.
 - Extremely short waveform data (less than approximately 100 msec) cannot be loaded.
 - The loop point settings within an AIFF file will be ignored.
 - Add the extension "WAV" to imported WAV files and the extension "AIF" to imported AIFF files.
 - You can load drum sounds of up to 13 seconds for a single drum kit.

(Example)

Kick: 3 seconds, snare: 3 seconds, crash cymbal: 7 seconds → Total 13 seconds
 - Stereo WAV and AIFF files are loaded as "mono" sounds with the left and right sides mixed.
1. Connect your computer and the BR-900CD with a USB cable.
 2. Confirm that the recorder is stopped, then press [UTILITY].
 3. Press CURSOR [◀] [▶] to move the cursor to "USB," and press [ENTER].
The USB screen appears.

4. Select "BACKUP" with the TIME/VALUE dial, then press [ENTER].

The Idling screen appears in the display.

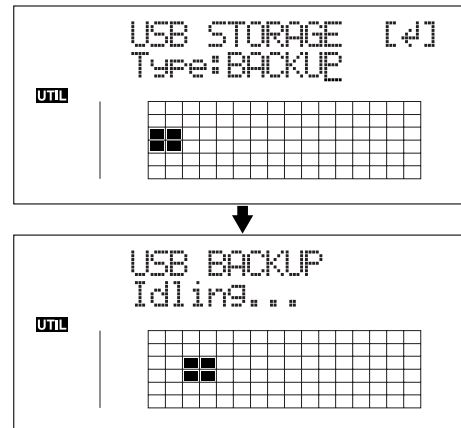

- * You cannot carry out the following procedure unless the Idling screen is displayed. Refer to p. 212 for instructions on resolving this problem.

The "BOSS_BR-900" icon is added to the computer.

(Ex.)



5. Import the WAV or AIFF file.
 - 1) Click the "BOSS_BR-900" icon.
 - 2) Drag the imported WAV or AIFF file to the "TONELOAD" folder in the "ROLAND" folder.

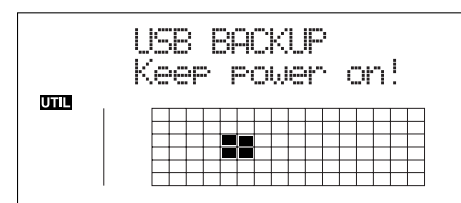

When you have finished importing the WAV or AIFF files, the Idling screen returns to the display.

6. Quit the connection to the computer.
 - 1) Drag the "BOSS_BR-900" icon into the trash.

7. Press BR-900CD's [EXIT] repeatedly to return to the Play screen.

* If you press [EXIT] without quitting the connection to the computer, the following screens appear. In this case, pressing [ENTER] and then [EXIT] returns the Play screen to the display.

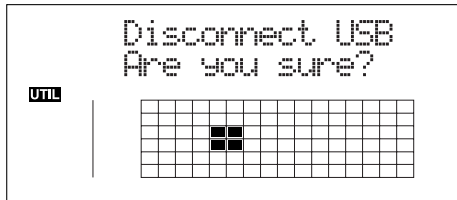

At this point, you can safely disconnect the USB cable from the BR-900CD and the computer.

8. Press [UTILITY].

9. Press CURSOR [◀] [▶] to move the cursor to "TONE," and press [ENTER].

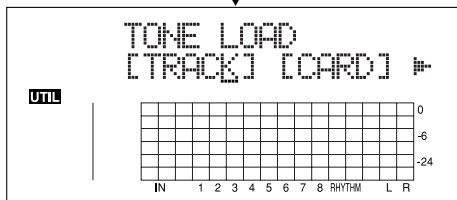
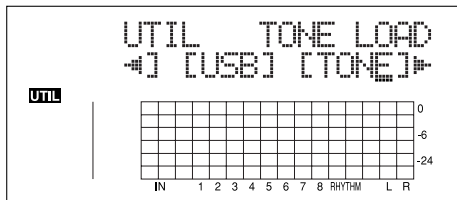

10. Press CURSOR [◀] [▶] to move the cursor to "CARD," and press [ENTER].

The names of the WAV and AIFF files on the memory card are displayed.

* WAV files are indicated by the symbol ".W"; ".A" indicates AIFF files.

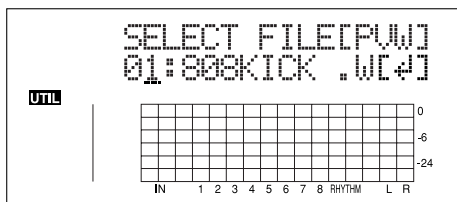

11. Turn the TIME/VALUE dial to select the WAV or AIFF file with the drum sound to be loaded.

MEMO

You can preview the sound of the WAV or AIFF file to be loaded by moving the cursor to "PVW" and pressing [ENTER].

12. Turn the TIME/VALUE dial to specify the load-destination song drum kit.

S1-5: Song Drum Kit 1-5

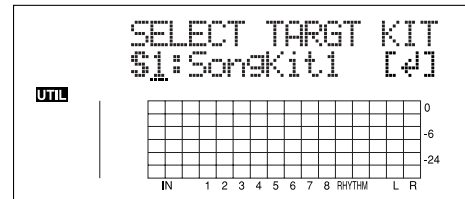

13. Turn the TIME/VALUE dial to select the load-destination song drum sound, then press [ENTER].

The load is executed.

To cancel, press [EXIT].

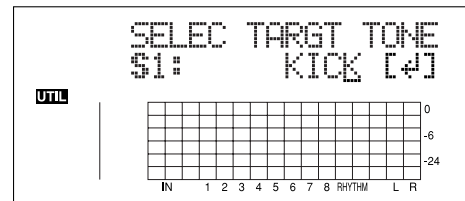

- * During updating, "Keep power on!" appears in the upper line of the display, while the lower line shows what is being processed.
- * WAV and AIFF files in the TONELOAD folder are retained without being deleted even after this procedure is completed. If these files are no longer needed, connect the BR-900CD to your computer via USB and use the computer to delete the files. Any files that are retained will use the required amount of memory on the memory card.

Using the BR-864 / BR-532's Data

You can use the BR-900CD to play BR-864 / BR-532 data.

* First be sure to back up the BR-864 / BR-532's "ROLAND" folder to the computer.

1. Initializing the memory card on the BR-900CD (p. 196).
2. Connect your computer and the BR-900CD with a USB cable.
3. Confirm that the recorder is stopped, then press [UTILITY].
4. Press CURSOR [◀] [▶] to move the cursor to "USB," and press [ENTER].
The USB screen appears.
5. Select "BACKUP" with the TIME/VALUE dial, then press [ENTER].
The Idling screen appears in the display.

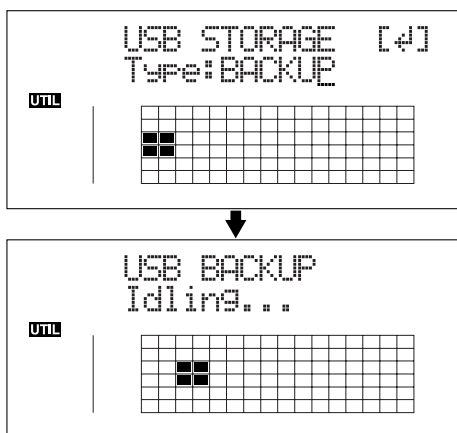

* You cannot carry out the following procedure unless the Idling screen is displayed. Refer to p. 212 for instructions on resolving this problem.

The "BOSS_BR-900" icon is added to the computer.

(Ex.)

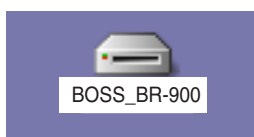

6. Delete the BR-900CD "ROLAND" folder.
 - 1) Double-click the "BOSS_BR-900" icon, and delete the "ROLAND" folder.
7. Drag the previously backed up BR-864 / BR-532 "ROLAND" folder to the "BOSS_BR-900" icon and drop it there.

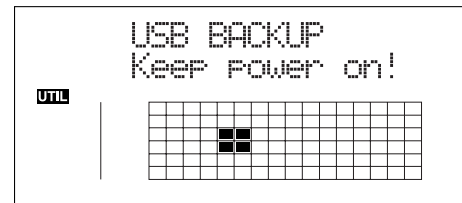

When you have finished backing up the data, the Idling screen returns to the display.

8. Quit the connection to the computer.
 - 1) Drag the "BOSS_BR-900" icon into the trash.
9. Press the BR-900CD's [EXIT].

The USB screen returns to the display.

* If you press [EXIT] without quitting the connection to the computer, the following screens appear. In this case, pressing [ENTER] returns the USB screen to the display.

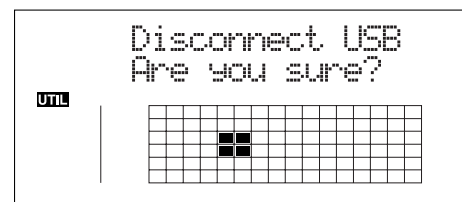

10. When backup of the data is complete, press [EXIT] to return to the Play screen.

At this point, you can safely disconnect the USB cable from the BR-900CD and the computer.

MEMO

Section 8

Other

Convenient

Functions

Adjusting the Display Contrast

Depending on where the BR-900CD is situated, the display contents may be difficult to read. If this is the case, perform the procedure given below to adjust the contrast (1 to 21).

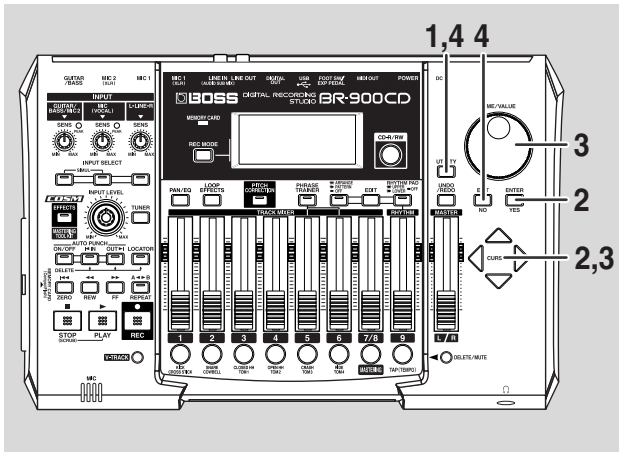

1. Press [UTILITY].
2. Press CURSOR [◀] [▶] to move the cursor to "SYS," and press [ENTER].

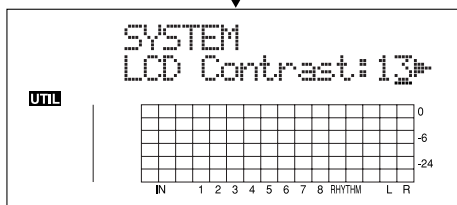
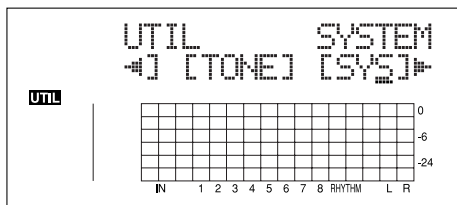

3. Press CURSOR [◀] [▶] to select "LCD Contrast," and adjust the contrast with the TIME/VALUE dial.

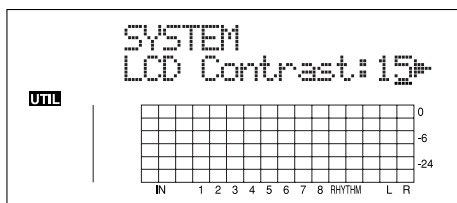

4. After completing the adjustment, press [UTILITY] (or press [EXIT] repeatedly) to return to the Play screen.

* During updating, "Keep power on!" appears in the upper line of the display, while the lower line shows what is being processed.

HINT

If you press and hold [UTILITY] while turning the TIME/VALUE dial, you will be able to change the contrast in real time. Choose the method that best suits the BR-900CD's setup.

Using a Foot Switch or Expression Pedal

You can connect an optional foot switch (such as the BOSS FS-5U or Roland DP-2) or expression pedal (such as the Roland EV-5 or BOSS FV-300L) to the FOOT SW/EXP PEDAL jack on the rear panel, allowing you to use your foot to control a number of functions.

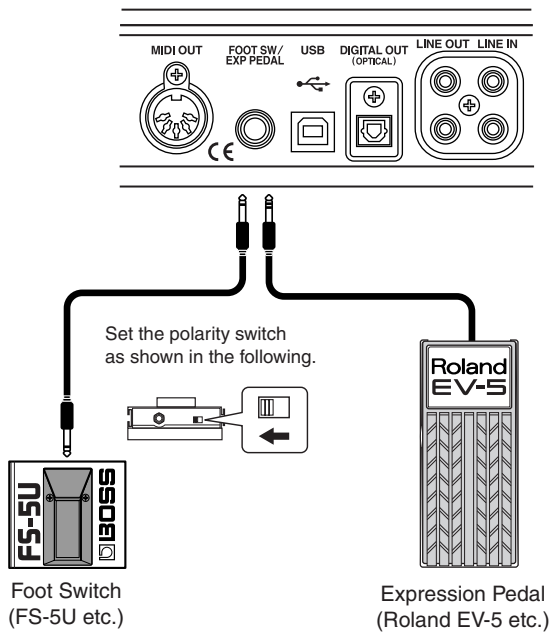

- * Use only the specified expression pedal (EV-5, FV-300L; optional). By connecting any other expression pedals, you risk causing malfunction and/or damage to the unit.
- * With the EV-5 and FV-300L, set the MIN volume to 0.
- * You can also use an FS-6 (optional) for the foot switch. If using an FS-6, connect to only one of the FS-6's jacks, either the A or B jack. Additionally, set the polarity switch to "FS-5U." The A&B jack cannot be used.

When Using a Foot Switch

Use the following procedure to set the foot switch function.

1. Press [UTILITY].
2. Press CURSOR [◀] [▶] to move the cursor to "SYS," and press [ENTER].

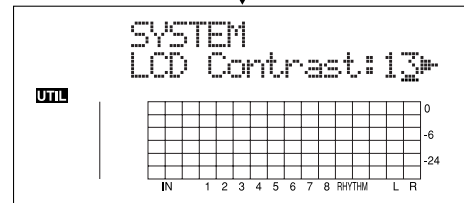
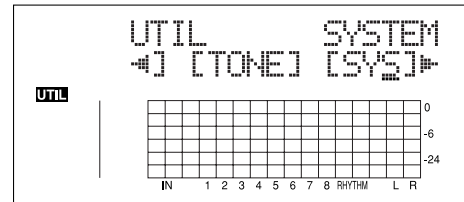

3. Press CURSOR [◀] [▶] and select "Foot SW."

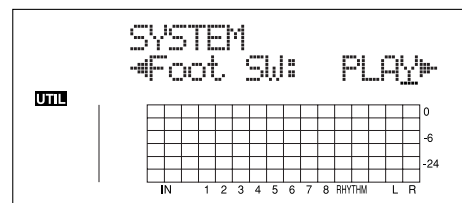

4. Turn the TIME/VALUE dial and select the foot switch function.

- PLAY:** The song will alternate between play and stop each time you press the foot switch.
- PUNCH:** Switches punch in and out alternately each time you press the foot switch.
- FX:** The insert effect will alternate between on and off each time you press the foot switch.

* Not operational while Pitch Correction is in use.

5. Press [UTILITY] (or press [EXIT] repeatedly) to return to the Play screen.

* During updating, "Keep power on!" appears in the upper line of the display, while the lower line shows what is being processed.

When Using an Expression Pedal

The expression pedal functions according to the effect settings, as shown below.

- Functions as a wah pedal when the Type for Wah (p. 101) is set to "PEDAL."
- Functions as a volume pedal when Foot Volume (p. 96) is set to "ON."
- The expression pedal functions as a pitch shifter pedal when Type for the Pitch Shifter (p. 98) is set to "PEDAL."

Tuning an Instrument (Tuner)

The BR-900CD has a built-in “chromatic tuner function” that allows you to tune your instrument quickly.

The built-in tuner supports both guitar and bass guitar.

As an example here, we will explain how to use the tuner to tune your guitar.

* *It is not possible to play back or record while using the tuner.*

Check the following points before you begin.

- That your guitar is connected to the GUITAR/BASS jack.
- That [GUITAR/BASS/MIC2] indicator on the INPUT SELECT button is lit.
- That GUITAR/BASS INPUT SENS is properly adjusted (p. 35).

If [GUITAR/BASS/MIC2] indicator is off, press [GUITAR/BASS/MIC2] to turn it on.

Changing to the Tuner

1. Press [TUNER] to access the Tuner screen.

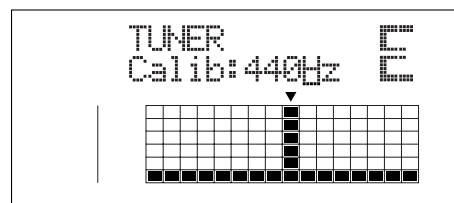

2. To exit the tuner, press [TUNER] once again (or press [EXIT]) to return to the Play screen.

MEMO

If you do not want to output the tuning sounds, either turn down the MASTER fader.

* *You cannot switch from the Tuner screen to other screens (except the Play screen).*

Explanation of the indications that appear while tuning

When the built-in tuner of the BR-900CD is used, the reference pitch is shown in the upper left of the display, and the note name in the right. The lower part will display a tuning guide to indicate the difference between the input sound and the displayed note.

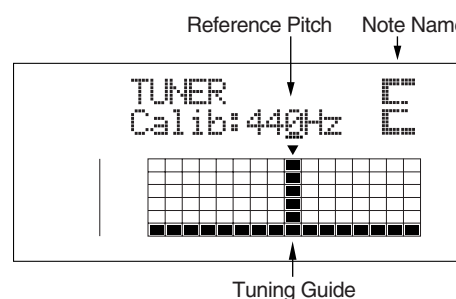

If the difference between the input pitch and the correct pitch is less than +/-50 cents, the tuning guide will indicate the amount of the difference.

Watch the tuning guide, Watch the tuning guide as you tune the instrument so that the vertical line is shown at the ▼ mark.

Tuning

1. Play a note using the string you are tuning.

The screen will indicate the note name that is closest to the pitch of the string you played.

* *Cleanly play a single note only on the string you wish to tune.*

2. Continue tuning until the pitch name of the string you are tuning appears in the display.

Normal tuning

	7th string	6th string	5th string	4th string	3rd string	2nd string	1st string
Guitar	B	E	A	D	G	B	E
Bass			B	E	A	D	G

3. Watch the tuning guide as you tune the instrument so that the vertical line is shown at the ▼ mark.

If the pitch of the string is within +/-50 cents of the correct pitch, the tuning guide will indicate the discrepancy between the actual and the correct pitches.

Your instrument is tuned above the displayed note (#)

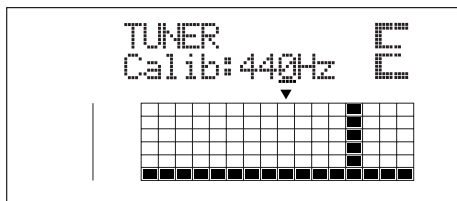

Your instrument is tuned the displayed note

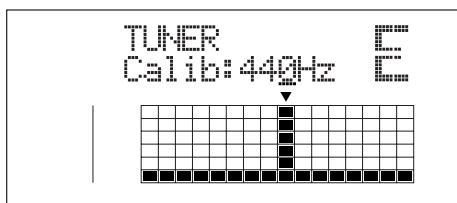

Your instrument is tuned below the displayed note (b)

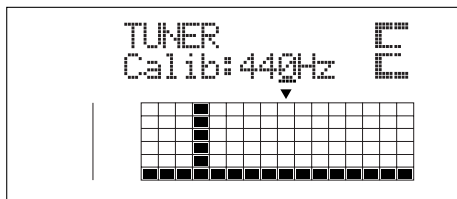

4. Repeat steps 1–3 to tune each of the strings.

* *If you are tuning a guitar that has a vibrato arm, tuning one string may cause other strings to drift. In this case, you should first tune the strings approximately so that the correct note name is displayed, and then re-tune each string.*

Setting the Reference Pitch of the Tuner

The reference pitch refers to the frequency of the A4 key (i.e., the "A" key at the center of a piano keyboard) from the instrument that serves as the reference pitch during performances (e.g., piano). On the BR-900CD, you can set the reference pitch of the tuner to any value between 435 and 445 Hz.

* *This was set to 440 Hz when the unit was shipped from the factory.*

1. Press [TUNER] to access the Tuner screen.

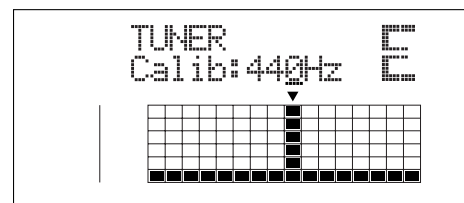

2. Turn the TIME/VALUE dial to change the reference pitch.

Calib (Calibrate): 435–445 Hz

3. To exit the tuner, press [TUNER] once again (or press [EXIT]) to return to the Play screen.

MEMO

The reference pitch set here is used as the reference pitch for Pitch Correction (p. 116).

Mixing the Output from an External MIDI Device with the Output from Your BR-900CD (Audio Sub Mix)

The Audio Sub Mix function allows you to mix the signal input from LINE IN with the signal output to LINE OUT. When performing synchronized playback using the BR-900CD and an external MIDI device, you can use the Audio Sub Mix function to mix the output from the external MIDI device with that of the BR-900CD internally, within the BR-900CD so you won't need an external mixer.

Also, since you can output the signal from the MIDI device without having to first record it to a track on the BR-900CD, you can use the BR-900CD tracks more effectively.

Sub Mixer : OFF

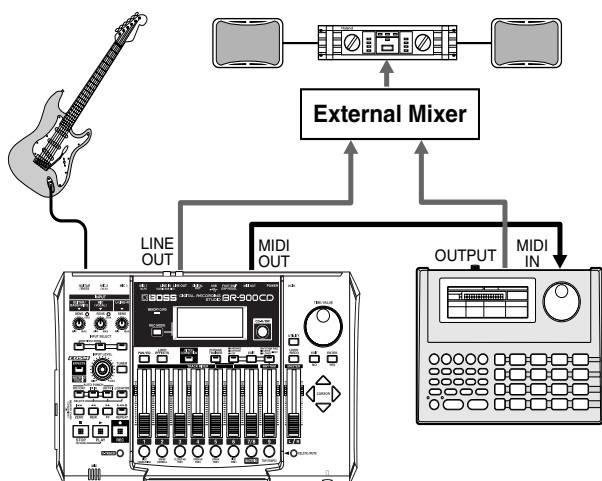

Sub Mixer : ON

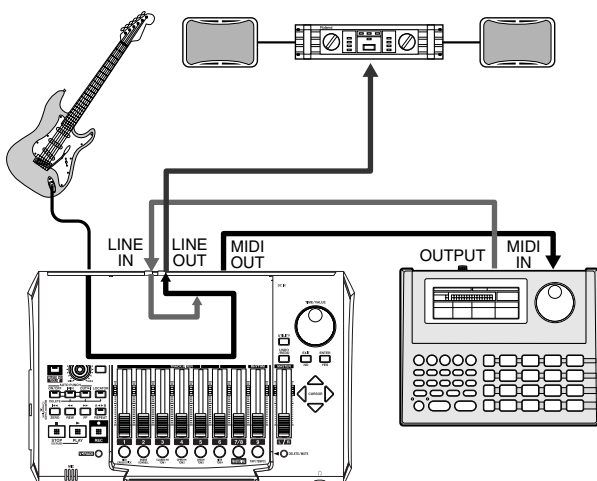

Using the Audio Sub Mix function

1. Press [UTILITY].
2. Press CURSOR [◀] [▶] to move the cursor to "SYS," and press [ENTER].

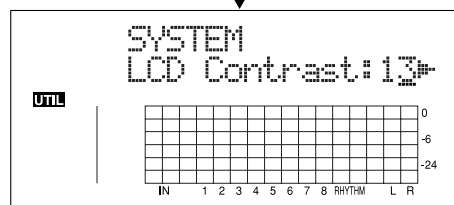
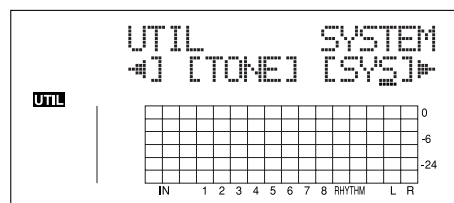

3. Press CURSOR [◀] [▶] to select "Sub Mixer," and turn the TIME/VALUE dial to turn the setting "ON."

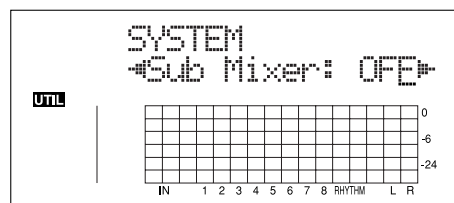

4. Press [UTILITY] (or press [EXIT] repeatedly) to return to the Play screen.
5. Turn the LINE SENS knob to adjust the sensitivity to the input from the external MIDI device.

NOTE

Even when the Sub Mixer is turned on, if you press INPUT SELECT [LINE], illuminating its indicator, the signal from LINE IN that passes through the recorder/mixer block is given priority, and the Sub Mixer will not work.

Using Condenser Microphones (Phantom Power)

Most condenser microphones need a supply of power known as phantom power in order to operate.

Accordingly, the BR-900CD can supply phantom power at +48 V to condenser microphones connected to any of the XLR-type connectors for MIC 1 and MIC 2.

MEMO

Phantom power

Condenser microphones generally contain a pair of thin opposing electrodes. When a voltage is applied across these electrodes, any vibration resulting from incoming audio will be output as electrical waves. However, since these waves are very weak, they must be boosted using amplification circuitry within the microphone itself. Phantom power is used to drive this amplification circuitry.

Certain types of condenser microphone use internal batteries as a source of power; accordingly, there will be no need to supply phantom power in such a case.

NOTE

Notes when using the Phantom power

- Phantom power should always be turned off when audio sources other than condenser microphones are being connected to the BR-900CD's. In fact, dynamic microphones, audio players, and the like can be damaged by this power supply. Always refer to the user's manual for the microphone to be used in order to confirm its phantom-power specifications.
- A supply of phantom power is not needed for certain types of condenser microphone (i.e., microphones featuring internal batteries, electric condenser microphones, etc.). Ensure that phantom power is set to "OFF" whenever one of these microphones is connected.
- The BR-900CD's MASTER fader, INPUT SENS GUITAR/BASS/MIC2 and MIC knobs, and INPUT LEVEL knobs must be moved all the way down when phantom power is being turned on or off. If this precaution is not observed, there is a possibility that amplifiers, speakers, and the like may be damaged by loud noises generated upon switching.

1. Before proceeding, turn INPUT SENS GUITAR/BASS/MIC2 and MIC knobs fully counter-clockwise in order to reduce the input volumes, and then move the MASTER fader and INPUT LEVEL knobs all the way down.

If any of these volumes is not reduced, a loud click may be output when the phantom power is turned on or off.

2. Press [UTILITY].
The Utility screen will appear.
3. Press CURSOR [◀] [▶] to move the cursor to "SYS," and press [ENTER].
4. Press CURSOR [◀] [▶] to select "Phantom SW," and turn the TIME/VALUE dial to turn the setting "ON."

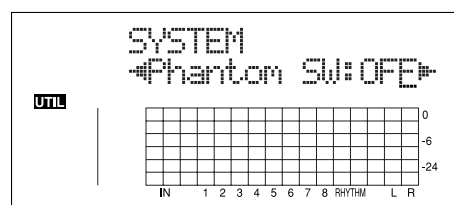

ON: Phantom power will be supplied.
Note that when turned on, phantom power will be supplied to all XLR connectors for MIC 1 and 2.

OFF: Phantom power will not be supplied.

5. Slowly raise the INPUT SENS knobs, the MASTER fader and INPUT LEVEL knobs, and confirm that an audio signal is being received from the condenser microphone(s).
6. To turn off the phantom power, repeat Steps 1 through 3, and then set "Phantom SW" to "OFF" in Step 4.

NOTE

- Phantom power cannot be turned on or off individually for MIC 1 and 2.
- Phantom power is not supplied to the 1/4" phone jack for MIC 1 or to the GUITAR/BASS jack.
- The phantom power setting reverts to "OFF" whenever the BR-900CD is turned on. Remember, therefore, to turn on this power supply whenever it is needed.
- No supply of phantom power will be needed from the BR-900CD when using an external microphone pre-amp or a dedicated, external phantom power supply. Ensure that phantom power is set to "OFF" in all such cases.

Copying Difficult Songs (Phrase Trainer)

Your BR-900CD features a built-in "Phrase Trainer." The Phrase Trainer records from the device connected to the input jacks (e.g., CD players or MD player) and then allows you to play back a part of that recording repeatedly to allow you to practice that portion again and again. You can also slow down the playback to aid in copying fast phrases or remove the guitar solo sound to play along with only the backing instruments as a practice aid.

NOTE

The Phrase Trainer can also be used with tracks 5 and 6.

- * You cannot perform recording while you are using the Phrase Trainer (Time Stretch or Center Cancel).
- * The following buttons are disabled while the Phrase Trainer is in use.
[PAN/EQ], [LOOP EFFECTS], [RHYTHM PAD]
- * The Rhythm does not sound when Phrase Trainer is on.

1. Record the song you want to copy onto tracks 5 and 6.

For how to record with the BR-900CD, refer to "(7) Basic Recording" (p. 39).

2. Repeat the portion of the song that you want to copy.

This will help you practice and copy a difficult phrase or guitar solo as you can select any portion of the song and have it repeated.

For how to repeat a portion of the song, refer to "Repeating Playback (Repeat)" (p. 51).

3. When using the Time Stretch and Center Cancel Function, press [PHRASE TRAINER] to make the indicator light.

Each time you press [PHRASE TRAINER], the Phrase Trainer is on (the [PHRASE TRAINER] indicator lights) and off (the indicator is off).

- * When you turn off both the Time Stretch Function and the Center Cancel Function, it doesn't light.

Slowing Down the Speed (Time Stretch)

The Time Stretch function allows you to slow down the speed of playback to a half of the normal speed without changing the pitch.

1. Press [PHRASE TRAINER].
2. Press CURSOR [◀] [▶] to select "TimeStrtch," and turn the TIME/VALUE dial to set "ON."

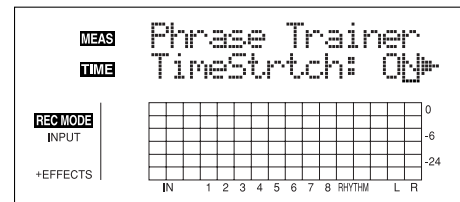

- ON:** Slows down playback to one-half without changing the pitch.
- OFF:** Pitch and playback speed are not changed.

Canceling the Center Sound (Center Cancel)

The Center Cancel function allows you to remove the central sound of the playback (e.g., vocals or guitar solos). This is helpful if you want to practice playing along with the backing instruments.

- * Depending on how the song was recorded, it may not be possible to completely remove the central sound.
- * Sounds are played back in mono.

1. Press [PHRASE TRAINER].
2. Press CURSOR [◀] [▶] to select "CentrCncel," and turn the TIME/VALUE dial to set it to "ON."

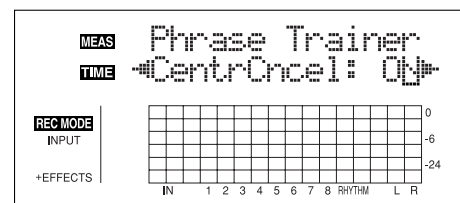

- ON:** Removes central sound (e.g., vocals or guitar solos).
- OFF:** Normal playback.

Perform the procedure below if the central sound is not removed as you desire or if you want to emphasize the bass sound.

- * When CentrCncel is set to "OFF," subsequent operations are disabled.

3. To emphasize the bass sound, press CURSOR [◀] [▶] to select "Low Boost," and turn the TIME/VALUE dial and adjust the value so that the bass sound is more easily heard.

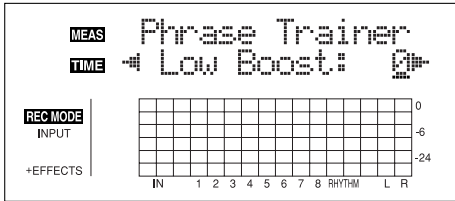

4. Press CURSOR [▶] to select "C.Adjust," and turn the TIME/VALUE dial and adjust the value of the sound that you want to remove to decrease its volume.

* Depending on how the song was recorded, these procedures may not be able to remove the sounds completely.

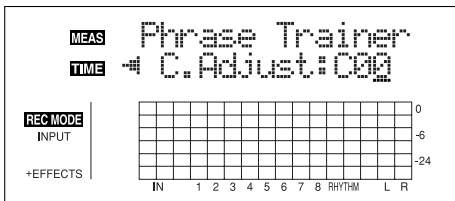

5. Press [EXIT] to return to the Play screen.



You can turn on both the Time Stretch and Center Cancel functions to use them together.

Initializing the BR-900CD's Settings

Initializing All the BR-900CD's Settings

The following settings are initialized together at one time.

- System Settings
- Effects (User Patches/Song Patches)
- Rhythm (Arrangements/Patterns/Drum Kits)

1. Press [UTILITY].
2. Press CURSOR [◀][▶] to move the cursor to "INI," and press [ENTER].

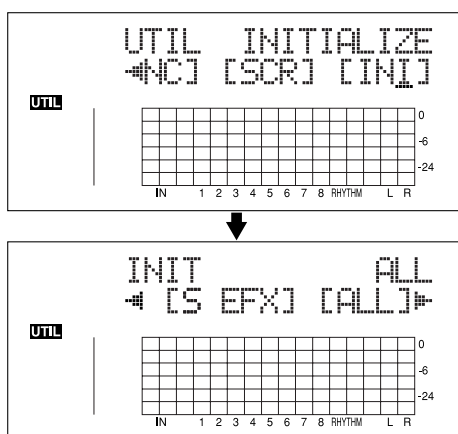

3. Press PARAMETER CURSOR [◀][▶] to move the cursor to "ALL," and press [ENTER].

The confirmation message "Are you sure?" appears in the display.

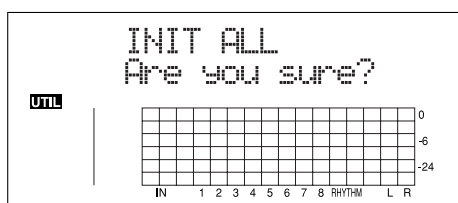

4. To continue the initialization, press [ENTER] (YES).

To cancel, press [EXIT] (NO) (or [UTILITY]).

When [ENTER] is pressed, initialization begins.

After the initialization has been completed, you are returned to the Play screen.

HINT

You can perform the same initialization with "INIT ALL," by holding down INPUT SELECT [GUITAR/BASS/MIC2], [MIC], and [LINE] while turning the POWER switch ON, then pressing [ENTER].

Initializing the System Settings

Follow the procedure below to initialize the system parameters.



A list of the initial settings for each parameter is given in the "Parameter List" (p. 208).

1. Press [UTILITY].
2. Press CURSOR [◀][▶] to move the cursor to "INI," and press [ENTER].

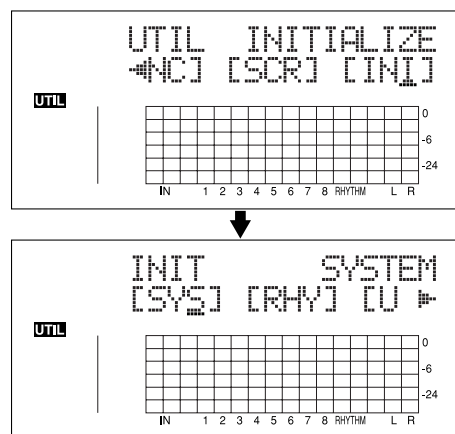

3. Press CURSOR [◀][▶] to move the cursor to "SYS," and press [ENTER].

The confirmation message "Are you sure?" appears in the display.

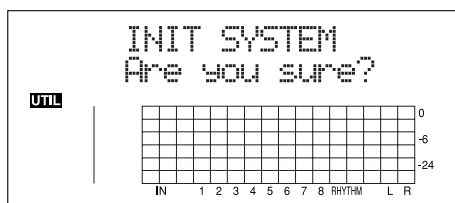

4. To continue the initialization, press [ENTER] (YES).

To cancel, press [EXIT] (NO) (or [UTILITY]).

When [ENTER] is pressed, initialization begins.

After the initialization has been completed, you are returned to the Play screen.

Initializing the Effect Settings

Follow the procedure below to initialize the user effect patches or song effect patches.

1. Press [UTILITY].
2. Press CURSOR [◀][▶] to move the cursor to "INI," and press [ENTER].

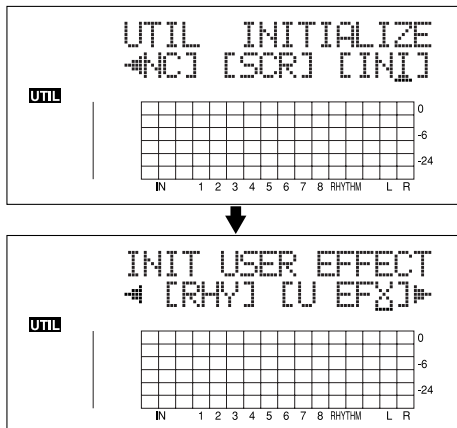

3. Press CURSOR [◀][▶] to move the cursor to "U EFX" (user patch) or "S EFX" (song patch), and press [ENTER].

The confirmation message "Are you sure?" appears in the display.

(Example) when you select "U EFX"

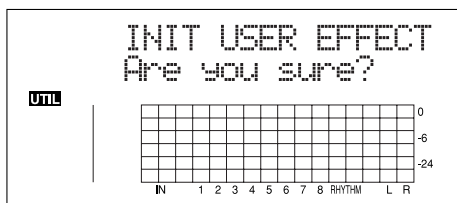

4. To continue the initialization, press [ENTER] (YES).
To cancel, press [EXIT] (NO) (or [UTILITY]).
When [ENTER] is pressed, initialization begins.
After the initialization has been completed, you are returned to the Play screen.

Initializing the Rhythm Arrangements/Patterns/Drum Kits

This initializes the Rhythm Arrangements, Patterns, and Drum Kits.

- In Song Arrangement, Step 1 is set to the metronome.
- In song patterns and song drum kits, the step is empty.

1. Press [UTILITY].
2. Press CURSOR [◀][▶] to move the cursor to "INI," and press [ENTER].

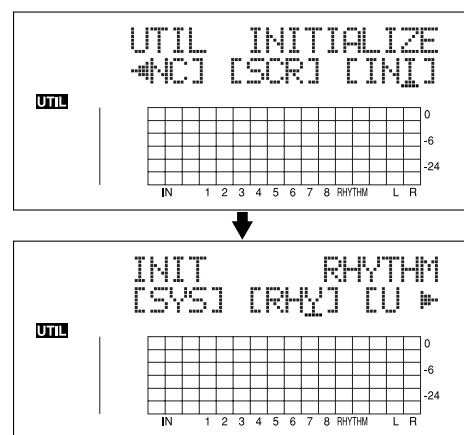

3. Press CURSOR [◀][▶] to move the cursor to "RHY," and press [ENTER].

The confirmation message "Are you sure?" appears in the display.

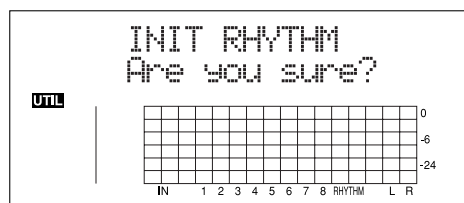

4. To continue the initialization, press [ENTER] (YES).
To cancel, press [EXIT] (NO) (or [UTILITY]).
When [ENTER] is pressed, initialization begins.
After the initialization has been completed, you are returned to the Play screen.

Initializing the Memory Card

NOTE

Be aware that when initialized, any existing data on the card will be erased.

- * If you initialize the memory card supplied with the BR-900CD, the demo songs on the card will be lost.

NOTE

Before you insert or remove a memory card, always turn off the BR-900CD first. If a memory card is inserted when the power is turned on, the data in the memory card may be destroyed, or the memory card may become unusable.

1. Press [UTILITY].
2. Press CURSOR [◀] [▶] to move the cursor to "INI," and press [ENTER].

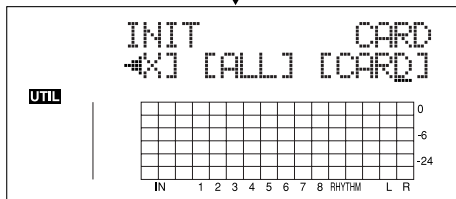
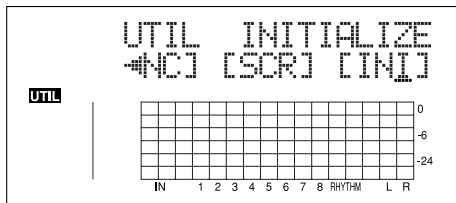

3. Press CURSOR [◀] [▶] to move the cursor to "CARD," and press [ENTER].

The confirmation message "Are you sure?" appears in the display.

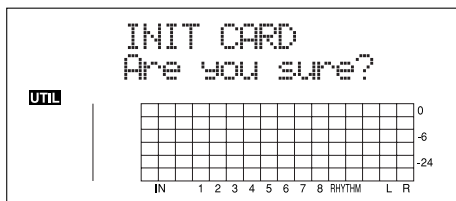

4. To continue the initialization, press [ENTER] (YES). To cancel, press [EXIT] (NO) (or [UTILITY]). When [ENTER] is pressed, initialization begins. When the initializing has been completed, "Completed!" appears in the display. "Keep power on! Song creating..." then appears in the display, and a new song is automatically created. In this case, the data type selected is HiFi (MT2). When creation of the song is finished, the play screen returns to the display.
- * Depending on the capacity of the memory card, initializing may take more than ten minutes to complete. This is not a malfunction. The progress of the initializing is shown in the display. Do not turn off the BR-900CD until the initializing has been completed.

NOTE

Do not remove the memory card or turn off the BR-900CD while the display shows "Keep power on!" Doing so can destroy the data on the memory card and/or render the memory card itself unusable.

Conserving Battery Power (Power Save)

Your BR-900CD is equipped with a power save function that limits the current dissipation during use.

When the power save function is activated, if no button, or TIME/VALUE dial on the BR-900CD is used for a certain amount of time, the BR-900CD will enter the standby state and turn off the display backlight and button indicators.

Also, when in the standby state, the display will appear as shown below.

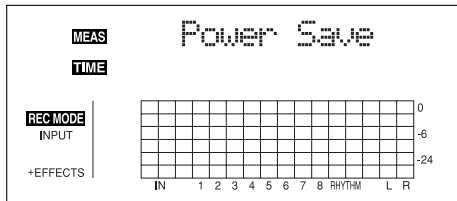

* The power save function is especially helpful when the BR-900CD is running on battery power.

Perform the procedure given below to activate the power save function.

1. Press [UTILITY].
2. Press CURSOR [◀] [▶] to move the cursor to "SYS," and press [ENTER].

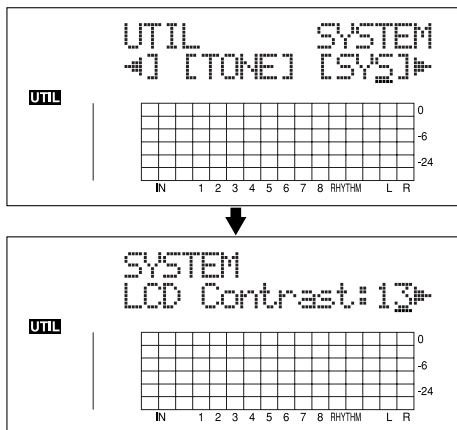

3. Press CURSOR [◀] [▶] to select "PowerSave," and turn the TIME/VALUE dial to set the time until the Power Save function is activated.

Valid Settings: OFF, 1min, 3min, 5min, 10min

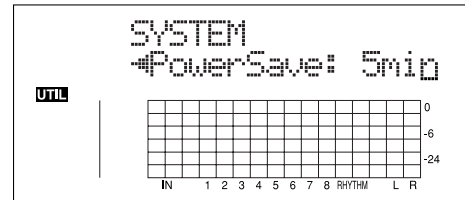

4. Press [UTILITY] (or press [EXIT] repeatedly) to return to the Play screen.

* During updating, "Keep power on!" appears in the upper line of the display, while the lower line shows what is being processed.

Deactivating the power save function

Press any of the panel buttons to deactivate power save.

* After the power save function is deactivated, the Play screen appears.

Utility Parameter List

Utilities include the following:

- “System parameters” for setting functions affecting the entire BR-900CD
- “Sync parameters” for setting synchronized performance functions
- “Scrub parameters” for setting scrub functions

About the System Parameters

This section describes the System parameters.

1. Press [UTILITY].
2. Press CURSOR [◀] [▶] to move the cursor to “SYS,” and press [ENTER].
3. Using CURSOR [◀] [▶], select the System parameter, then make the setting with the VALUE/TIME dial.

LCD Contrast

Valid Settings: 1–21 (Initial value: 13)

This sets the display contrast.

Foot Switch Assign (Foot SW)

Valid Settings: PLAY, PUNCH, FX (Initial value: PLAY)

This sets the function for the foot switch (an optional FS-5U or DP-2) connected to the FOOT SW/EXP PEDAL jack.

PLAY: Controls the recorder’s PLAY and STOP functions.

PUNCH: Controls Punch In/Out.

FX: Controls the insert effects On/Off.

Audio Sub Mix Switch (Sub Mixer)

Valid Settings: ON, OFF (Initial value: OFF)

This setting turns the Audio Sub Mix function (output mix of the external inputs from LINE IN) on and off.

Internal mic switch (Mic)

Valid Settings: EXTERNAL, ONBRD+EXT (Initial value: EXTERNAL)

Use this setting to input only the sound from the external mic connected to MIC 1, or to switch on the internal mic and input a mix of the sounds from the internal and external mics.

Phantom power switch (Phantom SW)

Valid Settings: ON, OFF (Initial value: OFF)

This setting turns the phantom power on and off.

AB Quantize (AB Qtz)

Valid Settings: ON, OFF (Initial value: OFF)

This setting turns the “Quantize function” on and off.

“Quantize” is a function that enables you to set the start and end points in measure units when making the settings for repeat playback (the repeated portion).

Remain Information (Remain Inf)

Valid Settings: ON, OFF (Initial value: OFF)

This indicates the remaining amount of recording time available in the display during recording standby or while recording is in progress.

Power Save Mode (PowerSave)

Valid Settings: OFF, 1, 3, 5, 10 (min) (Initial value: OFF)

This setting turns the “Power Save function” on and off.

“Power Save” is a function that reduces power consumption through such power-saving measures as switching off the display’s illumination if no operation is performed for a set period of time (for one, three, five, or ten minutes). This is effective in preventing excess battery drain.

About the Sync Parameters

This section describes the Sync parameters.

1. Press [UTILITY].
2. Press CURSOR [◀] [▶] to move the cursor to “SYNC,” and press [ENTER].
3. Using CURSOR [◀] [▶], select the Sync parameter, then make the setting with the VALUE/TIME dial.

Sync Generator (Sync Gen)

Valid Settings: OFF, MTC, MCK (Initial value: OFF)

This sets the synchronization signals output from the MIDI OUT connector.

OFF: No synchronization signal is output from MIDI OUT.

MTC: MTC synchronization signals are output from MIDI OUT.

MCK: MIDI CLOCK synchronization signals are output from MIDI OUT.

MMC Master

Valid Settings: ON, OFF (Initial value: OFF)

This setting determines whether or not the Master MMC code is output from the MIDI OUT connector.

MTC Type**Valid Settings: 30, 29N, 29D, 25, 24 (Initial value: 30)**

This sets the type of MTC output from the MIDI OUT connector.

- 30:** 30 frames per second non-drop format. This is used by audio devices such as analog tape recorders, and for NTSC format black and white video (used in Japan and the U.S.).
- 29N:** 29.97 frames per second non-drop format. This is used for NTSC format color video (used in Japan and the U.S.).
- 29D:** 29.97 frames per second drop format. This is used for NTSC format broadcast color video (used in Japan and the U.S.).
- 25:** 25 frame per second frame rate. This is used for SECAM or PAL format video, audio equipment, and film (used in Europe and elsewhere).
- 24:** 24 frame per second frame rate. This is used for video, audio devices, and film in the US.

Rhythm MIDI Channel (RhyMIDI ch)**Valid Settings: 1–16, OFF (Initial value: 10)**

This sets the MIDI channel for the Rhythm performance data output from the MIDI OUT connector. No data is output when this is set to OFF.

Offset**Valid Settings: 00:00:00-00.0–23:59:59-29.9 (Initial value: 00:00:00-00.0)**

Sets the time required to align the song playback and MTC timing when synchronizing an external device using MTC from the BR-900CD.

The offset is set as the difference between the “time to which to align the MTC timing” and the “time to which to align the song timing.” For example, you want to have the external device play back with the MTC timing shown below when the song timing reaches “01h00m00s00,” then set the offset as follows.

Song Timing	MTC for External Device	Offset Setting
01h00m00s00	01h30m00s00	00h30m00s00
01h00m00s00	00h30m00s00	23h30m00s00



The Offset is stored to each song individually.

About the Scrub Parameters

This section describes the Scrub parameters.

1. Press [UTILITY].
2. Press CURSOR [◀] [▶] to move the cursor to “SCR,” and press [ENTER].
3. Using CURSOR [◀] [▶], select the Scrub parameter, then make the setting with the TIME/VALUE dial.

Scrub Mode From/To**Valid Settings: FROM, TO (Initial value: FROM)**

This sets the “Scrub function” mode.

“Scrub” is a function for repeatedly playing back material of an extremely short duration (approximately 45 msec).

You can get scrub playback by holding down [STOP] and pressing [PLAY].

FROM: Provides about 45 milliseconds of scrub playback starting from the current location.

TO: Provides about 45 milliseconds of scrub playback ending up at the current location.

Preview Switch (Preview SW)**Valid Settings: ON, OFF (Initial value: OFF)**

This setting turns the “Preview function” on and off.

When the Preview switch is set to ON, pressing [REW] during scrub playback provides one second of playback time starting from the current location, while pressing [FF] provides one second of playback time ending up at the current location.

MEMO

Section 9

Appendices

Effect Patch List

■ GTR (GUITAR/BASS)

No.	Patch Name	Algorithm
01	JC Clean	COSM GTR AMP
02	HiGainLd	COSM GTR AMP
03	Over Drv	COSM GTR AMP
04	Phased	COSM GTR AMP
05	Crunch	COSM GTR AMP
06	MS Strgt	COSM GTR AMP
07	St WACK	COSM GTR AMP
08	Ambient	COSM GTR AMP
09	Voxy!	COSM GTR AMP
10	St Metal	COSM GTR AMP
11	TREM'TWN	COSM GTR AMP
12	StdAmp F	COSM GTR AMP
13	StdAmp M	COSM COMP GTR
14	St Flang	COSM GTR AMP
15	TEXAS	COSM GTR AMP
16	HiGainMS	COSM GTR AMP
17	StThrash	COSM GTR AMP
18	SWEET LD	COSM GTR AMP
19	BIG COMP	COSM GTR AMP
20	PowChord	COSM GTR AMP
21	Uni-Wah	COSM GTR AMP
22	Gt Pad	COSM GTR AMP
23	D-CompLd	COSM COMP GTR
24	DrivenLd	COSM GTR AMP
25	RockLead	COSM GTR AMP
26	RAGE!	COSM GTR AMP
27	ClearSky	COSM GTR AMP
28	60s UK	COSM COMP GTR
29	TubeStck	COSM GTR AMP
30	StSustin	COSM GTR AMP
31	Country	COSM COMP GTR
32	ClapLead	COSM GTR AMP
33	TURND211	COSM GTR AMP
34	80'sHard	COSM GTR AMP
35	90'sMetl	COSM GTR AMP
36	Bubbling	COSM GTR AMP
37	BIG FUNK	COSM COMP GTR
38	Dirty	COSM GTR AMP
39	MatchDrv	COSM GTR AMP
40	St AltLd	COSM GTR AMP
41	PhatPhas	COSM GTR AMP
42	SocrFild	COSM GTR AMP
43	UK Gtr	COSM COMP GTR
44	DOWN 2 D	COSM GTR AMP
45	CmpBilly	COSM COMP GTR
46	JC Metal	COSM GTR AMP
47	LATE70's	COSM GTR AMP
48	EARY70's	COSM GTR AMP
49	American	COSM GTR AMP
50	Heavy	COSM GTR AMP

No.	Patch Name	Algorithm
51	Hard Drv	COSM GTR AMP
52	HyperMtl	COSM GTR AMP
53	Metal Ld	COSM GTR AMP
54	ResoLead	COSM GTR AMP
55	ARPEGGIO	COSM GTR AMP
56	SmallAmp	COSM GTR AMP
57	CleanLd	COSM COMP GTR
58	BluesyLd	COSM GTR AMP
59	Delayed	COSM GTR AMP
60	Wah Lead	COSM GTR AMP
61	FatClean	COSM COMP GTR
62	ClnTubes	COSM GTR AMP
63	Std MkII	COSM GTR AMP
64	Crunchy	COSM GTR AMP
65	Aussie	COSM GTR AMP
66	DarfBlus	COSM GTR AMP
67	HeadinWM	COSM GTR AMP
68	BG Lead	COSM GTR AMP
69	FixedWah	COSM GTR AMP
70	BIG 3RDS	COSM GTR AMP
71	ACOUSTY	ACOUSTIC SIM
72	BrightAc	ACOUSTIC SIM
73	ACO w/PZ	ACOUSTIC SIM
74	AC4Slide	ACOUSTIC SIM
75	Dream Ac	ACOUSTIC SIM
76	TigtBass	BASS SIM
77	LoosBass	BASS SIM
78	B.SIM+Ch	BASS SIM
79	UprtPhsd	BASS SIM
80	G>FRTLES	BASS SIM
81	Natural	ACOUSTIC GTR
82	AcstSolo	ACOUSTIC GTR
83	MIC'D AC	ACOUSTIC GTR
84	NICE ACS	ACOUSTIC GTR
85	WIDE ACS	ACOUSTIC GTR
86	SLAPnPOP	BASS MULTI
87	PhasBass	BASS MULTI
88	FLIPTOP	COSM BASS AMP
89	Squezbas	COSM COMP BSS
90	StdoBass	COSM COMP BSS
91	BassTube	COSM BASS AMP
92	PunkBass	COSM BASS AMP
93	SUSTAIN	COSM COMP BSS
94	Big8-Stg	BASS MULTI
95	FRETLESS	BASS MULTI
96	STADIUM	COSM COMP BSS
97	OCTAVE	BASS MULTI
98	NO FRET	BASS MULTI
99	DRV BASS	COSM BASS AMP

■ MIC

No.	Patch Name	Algorithm
01	Vo Comp1	COSM COMP VCL
02	Vo Comp2	COSM COMP VCL
03	Kick Cmp	COSM COMP VCL
04	SnareCmp	COSM COMP VCL
05	BrassCmp	COSM COMP VCL
06	VocalFx1	VOCAL MULTI
07	VocalFx2	VOCAL MULTI
08	VocalFx3	VOCAL MULTI
09	VocalFx4	VOCAL MULTI
10	NARRATOR	VOCAL MULTI
11	VOX DOUB	VOCAL MULTI
12	VOX DETN	VOCAL MULTI
13	KARAOKE	VOCAL MULTI
14	UNISON	VOICE TRANS
15	STUTTER	VOICE TRANS
16	D.VADER	VOICE TRANS
17	ALIEN	VOICE TRANS
18	BullHorn	VOCAL MULTI
19	SEAGULLS	VOICE TRANS
20	SO DEEP!	VOICE TRANS
21	BrightCh	VOCAL MULTI
22	FatBrass	VOCAL MULTI
23	Dark EQ	VOCAL MULTI
24	Vocal EQ	VOCAL MULTI
25	BrightEQ	VOCAL MULTI
26	Enh+BCut	VOCAL MULTI
27	ST.PAN	VOCAL MULTI
28	SLOW FLG	VOCAL MULTI
29	FAST FLG	VOCAL MULTI
30	SLOW CHO	VOCAL MULTI
31	SLAPBACK	VOCAL MULTI
32	BigEQ+DL	VOCAL MULTI
33	BalladFx	VOCAL MULTI
34	PTCH-1/2	VOCAL MULTI
35	PTCH+1/2	VOCAL MULTI
36	CM+DS+EH	VOCAL MULTI
37	CM+EH+EQ	VOCAL MULTI
38	CM+DS+EQ	VOCAL MULTI
39	CM+EQ+DB	VOCAL MULTI
40	CM+EQ+DT	VOCAL MULTI

■ LIN (LINE)

No.	Patch Name	Algorithm
01	CM+FatEQ	STEREO MULTI
02	CM+ThnEQ	STEREO MULTI
03	Tight EQ	STEREO MULTI
04	CM+BigEQ	STEREO MULTI
05	SMALL EQ	STEREO MULTI
06	T'WAH UP	STEREO MULTI
07	T'WAH DW	STEREO MULTI
08	R.MOD:LO	STEREO MULTI
09	R.MOD:HI	STEREO MULTI
10	TotalMod	STEREO MULTI
11	DEEP FLG	STEREO MULTI
12	LO&SLOW	STEREO MULTI
13	LO&FAST	STEREO MULTI
14	HI&SLOW	STEREO MULTI
15	HI&FAST	STEREO MULTI
16	StChorus	STEREO MULTI
17	SlowChrs	STEREO MULTI
18	FastChrs	STEREO MULTI
19	PRE-DLY	STEREO MULTI
20	VntgPhas	STEREO MULTI
21	MdrmPhas	STEREO MULTI
22	DeepPhas	STEREO MULTI
23	PhatPhas	STEREO MULTI
24	PS:DETUN	STEREO MULTI
25	PS:-1OCT	STEREO MULTI
26	PS:+1OCT	STEREO MULTI
27	ST DOUBL	STEREO MULTI
28	MONO>>ST	STEREO MULTI
29	SLOW PAN	STEREO MULTI
30	FAST PAN	STEREO MULTI
31	CHRS+DLY	STEREO MULTI
32	CHRS+TAP	STEREO MULTI
33	PH+SLPBK	STEREO MULTI
34	FLNG+TAP	STEREO MULTI
35	LoCmbFlt	STEREO MULTI
36	HiCmbFlt	STEREO MULTI
37	120 RMOD	STEREO MULTI
38	PAN+DLY	STEREO MULTI
39	ST TREM	STEREO MULTI
40	120 SLIC	STEREO MULTI
41	20sRadio	LO-FI BOX
42	40sRadio	LO-FI BOX
43	60sRadio	LO-FI BOX
44	PHONGRPH	LO-FI BOX
45	Vntg45's	LO-FI BOX
46	CLASC LP	LO-FI BOX
47	VntgSmpl	LO-FI BOX
48	1985Smpl	LO-FI BOX
49	R-ModSmp	LO-FI BOX
50	2-BIT DS	LO-FI BOX

Effect Patch List

■ SML (SIMUL)

No.	Patch Name	Algorithm
01	EQ + JC	VO+GT AMP
02	DELAY+JC	VO+GT AMP
03	CMP+TWIN	VO+GT AMP
04	EQ+twin	VO+GT AMP
05	CMP+SMAL	VO+GT AMP
06	EQ+CRNCH	VO+GT AMP
07	EQ+MATCH	VO+GT AMP
08	DL+match	VO+GT AMP
09	EQ+VO	VO+GT AMP
10	COMP+vo	VO+GT AMP
11	CMP+BLUS	VO+GT AMP
12	CMP+BG	VO+GT AMP
13	DELAY+bg	VO+GT AMP
14	DL+MS(1)	VO+GT AMP
15	DL+ms(1)	VO+GT AMP
16	DL+MS1+2	VO+GT AMP
17	CM&EQ+ms	VO+GT AMP
18	DLY+SLDN	VO+GT AMP
19	CMP+METL	VO+GT AMP
20	EQ+METAL	VO+GT AMP
21	DI+H-STD	VO+AC.SIM
22	EQ+S-STD	VO+AC.SIM
23	CM+H-JUM	VO+AC.SIM
24	CM+S-JUM	VO+AC.SIM
25	DL+H-ENH	VO+AC.SIM
26	CM+S-ENH	VO+AC.SIM
27	EQ+H-PZO	VO+AC.SIM
28	DL+S-PZO	VO+AC.SIM
29	CMP+PZO1	VO+AC.SIM
30	DL+PZO2	VO+AC.SIM
31	DIR+SIM1	VO+AC.SIM
32	CMP+SIM2	VO+AC.SIM
33	EQ+SIM3	VO+AC.SIM
34	DL+SIM4	VO+AC.SIM
35	CMP+SIM5	VO+AC.SIM
36	COMP+AC	VO+ACOUSTIC
37	COMP+CLS	VO+ACOUSTIC
38	COMP+DIS	VO+ACOUSTIC
39	COMP+FAR	VO+ACOUSTIC
40	COMP+DYN	VO+ACOUSTIC
41	COMP+MIC	VO+ACOUSTIC
42	COMP+DIR	VO+ACOUSTIC
43	NS+VNTG	VO+ACOUSTIC
44	CMP+CMP1	VO+ACOUSTIC
45	DI+COMP2	VO+ACOUSTIC
46	CMP+CMP3	VO+ACOUSTIC
47	NS+COMP4	VO+ACOUSTIC
48	CMP+CMP5	VO+ACOUSTIC
49	COMP+SML	VO+ACOUSTIC
50	COMP+LRG	VO+ACOUSTIC

Mastering Tool Kit Patch List

■ MTK (MASTERING TOOL KIT)

No.	Patch Name
01	Mix Down
02	PreMastr
03	Live Mix
04	Pop Mix
05	DanceMix
06	JinglMix
07	HardComp
08	SoftComp
09	CleanCmp
10	DanceCmp
11	OrchComp
12	VocalCmp
13	Acoustic
14	RockBand
15	Orchestr
16	LowBoost
17	Brighten
18	DJsVoice
19	PhoneVox

Pitch Correction Patch List

■ PCR (PITCH CORRECTION)

No.	Patch Name
P01	Alto
P02	Soprano
P03	Tenor
P04	Baritone
P05	Machine

Arrangement / Pattern List

Preset Arrangement List

Each of the preset Arrangement (except Metro4/4) is set so that a three-measure BREAK, followed by V1 (verse) comes after the E (ending).

No.	Arrangement Name	Initial Tempo	Beat	Starting measure							BREAK	V1	Drum Kit
				IN	V1	F1	V2	F2	V2	END			
P01	ROCK1	130	4/4	1	2	4	6	8	10	12	16	19	ROOM
P02	ROCK2	130	4/4	1	3	5	7	9	11	13	17	20	ROOM
P03	ROCK3	118	4/4	1	3	6	7	10	11	15	17	20	ROOM
P04	ROCK4	118	4/4	1	5	8	9	12	13	15	19	22	ROOM
P05	ROCK5	104	4/4	1	5	8	9	12	13	15	17	20	ROOM
P06	ROCK6	86	4/4	1	2	9	10	17	18	22	24	27	STD 2
P07	HdRck1	130	4/4	1	5	8	9	12	13	15	18	21	ROOM
P08	HdRck2	98	4/4	1	3	10	11	18	19	23	25	28	HARD
P09	HdRck3	126	4/4	1	5	8	9	12	13	15	20	23	ROOM
P10	HdRck4	120	4/4	1	4	7	8	11	12	15	18	21	ROOM
P11	HdRck5	118	4/4	1	2	5	6	9	10	12	13	16	ROOM
P12	HEAVY1	210	4/4	1	5	11	13	19	21	25	29	32	HARD
P13	HEAVY2	120	4/4	1	3	9	11	17	19	21	23	26	HARD
P14	HEAVY3	120	4/4	1	3	9	11	17	19	21	24	27	HARD
P15	HEAVY4	162	4/4	1	3	9	11	17	19	21	24	27	ROOM
P16	HEAVY5	109	4/4	1	5	8	9	12	13	15	16	19	ROOM
P17	POP1	118	4/4	1	3	6	7	10	11	13	17	20	ROOM
P18	POP2	118	4/4	1	3	6	7	10	11	13	15	18	STD1
P19	POP3	118	4/4	1	3	6	7	10	11	13	15	18	ROOM
P20	POP4	118	4/4	1	3	6	7	10	11	13	17	20	ROOM
P21	POP5	140	4/4	1	3	6	7	10	11	13	15	18	ROOM
P22	POP6	96	4/4	1	3	6	7	10	11	13	15	18	STD 1
P23	POP7	66	4/4	1	4	7	8	11	12	14	16	19	STD 2
P24	POP8	151	4/4	1	5	8	9	16	17	21	24	27	STD 1
P25	BALLAD1	70	4/4	1	5	8	9	12	13	15	18	21	ROOM
P26	BALLAD2	89	4/4	1	2	5	6	9	10	12	14	17	STD 2
P27	BLUES1	124	4/4	1	2	5	6	9	10	13	16	19	STD 2
P28	BLUES2	192	4/4	1	5	12	13	20	21	25	29	32	STD 1
P29	BLUES3	124	4/4	1	3	10	11	18	19	23	26	29	STD 2
P30	BLUES4	148	4/4	1	5	8	9	12	13	15	17	20	STD 1
P31	R&B1	110	4/4	1	5	8	9	12	13	15	18	21	STD 1
P32	R&B2	154	4/4	1	3	6	7	10	11	13	18	21	STD 1
P33	R&B3	108	4/4	1	5	8	9	12	13	15	18	21	STD 2
P34	R&B4	96	4/4	1	5	12	13	20	21	25	26	29	STD 1
P35	R&B5	94	4/4	1	5	8	9	12	13	15	19	22	STD 1
P36	JAZZ1	140	4/4	1	3	5	7	9	11	13	15	18	JAZZ
P37	JAZZ2	140	4/4	1	5	7	9	11	13	15	17	20	JAZZ
P38	JAZZ3	140	4/4	1	5	12	13	20	21	25	30	33	JAZZ
P39	FUSION1	120	4/4	1	5	12	13	20	21	25	29	32	STD2
P40	FUSION2	118	4/4	1	2	5	6	9	10	12	15	18	ROOM
P41	HipHop1	93	4/4	1	2	9	10	17	18	22	23	26	HIP-HOP
P42	HipHop2	102	4/4	1	3	10	11	18	19	23	25	28	808
P43	FUNK	110	4/4	1	2	4	6	8	10	12	13	16	HIP-HOP
P44	HOUSE	114	4/4	1	3	6	7	10	11	13	15	18	HOUSE
P45	Cntry1	118	4/4	1	3	6	7	10	11	13	14	17	JAZZ
P46	Cntry2	118	4/4	1	2	5	6	9	10	12	14	17	JAZZ
P47	Other1	96	4/4	1	2	9	10	17	18	22	24	27	REGGAE
P48	Other2	118	4/4	1	5	7	9	11	13	15	19	22	STD 2
P49	Other3	125	4/4	1	2	5	6	9	10	12	14	17	ROOM
P50	Metro4/4	120	4/4	1	-	-	-	-	-	-	-	-	STD 1

Preset Pattern List

Pattern Name (Abbreviation shown in display)	Initial Tempo	Beat	Measure					
			IN	V1	F1	V2	F2	E
ROCK1	130	4/4	1	2	2	2	2	4
ROCK2	130	4/4	2	2	2	2	2	4
ROCK3	118	4/4	2	2	1	2	1	2
ROCK4	118	4/4	4	2	1	2	1	4
ROCK5	104	4/4	4	2	1	2	1	2
ROCK6	86	4/4	1	4	1	4	1	2
Hard Rock 1(HdRc1)	130	4/4	4	2	1	2	1	3
Hard Rock 1(HdRc2)	98	4/4	2	4	1	4	1	2
Hard Rock 1(HdRc3)	126	4/4	4	2	1	2	1	5
Hard Rock 1(HdRc4)	120	4/4	3	2	1	2	1	3
Hard Rock 1(HdRc5)	118	4/4	1	1	1	1	1	1
HEAVY1 (HEVY1)	210	4/4	4	4	2	4	2	4
HEAVY2 (HEVY2)	120	4/4	2	2	2	2	2	2
HEAVY3 (HEVY3)	120	4/4	2	2	2	2	2	3
HEAVY4 (HEVY4)	162	4/4	2	2	2	2	2	3
HEAVY5 (HEVY5)	109	4/4	4	2	1	2	1	1
POP1	118	4/4	2	2	1	2	1	4
POP2	118	4/4	2	2	1	2	1	2
POP3	118	4/4	2	2	1	2	1	2
POP4	118	4/4	2	1	1	1	1	4
POP5	140	4/4	2	1	1	1	1	2
POP6	96	4/4	2	2	1	2	1	2
POP7	66	4/4	3	2	1	2	1	2
POP8	151	4/4	4	2	1	4	1	3
BALLAD1 (BALD1)	70	4/4	4	2	1	2	1	3
BALLAD2 (BALD2)	89	4/4	1	2	1	2	1	2
BLUES1 (BLUS1)	124	4/4	1	4	1	4	1	3
BLUES2 (BLUS2)	192	4/4	4	4	1	4	1	4
BLUES3 (BLUS3)	124	4/4	2	2	1	2	1	3
BLUES4 (BLUS4)	148	4/4	4	2	1	2	1	2
R&B1	110	4/4	4	2	1	2	1	3
R&B2	154	4/4	2	2	1	2	1	5
R&B3	108	4/4	4	2	1	2	1	3
R&B4	96	4/4	4	4	1	4	1	1
R&B5	94	4/4	4	2	1	2	1	4
JAZZ1	140	4/4	2	2	2	2	2	2
JAZZ2	140	4/4	4	2	2	2	2	2
JAZZ3	140	4/4	4	4	1	4	1	5
FUSION1 (FUSN1)	120	4/4	4	4	1	4	1	4
FUSION2 (FUSN2)	118	4/4	1	2	1	2	1	3
HipHop1 (H.Hp1)	93	4/4	1	4	1	4	1	1
HipHop2 (H.Hp2)	102	4/4	2	4	1	4	1	2
FUNK	110	4/4	1	2	2	2	2	1
HOUSE	114	4/4	2	2	1	2	1	2
Cntry1 (Cnty1)	118	4/4	2	1	1	1	1	1
Cntry2 (Cnty2)	118	4/4	1	2	1	2	1	2
OTHER1 (Othr1)	96	4/4	1	4	1	2	1	2
OTHER2 (Othr1)	118	4/4	4	2	2	2	2	4
OTHER3 (Othr1)	125	4/4	1	2	1	2	1	2
Metro	-	-	-	-	-	-	-	-
BREAK	-	-	-	-	-	-	-	-

Parameter List

(*1) If you want to save the settings as the currently selected song data, hold down [STOP] and press [REC].

(*2) Stored in the BR-900CD.

(*3) Not Stored.

Mixer Parameter (*1)

Parameter Name	Display	Initial Value	Valid Settings
Input Select	-	GUITAR/BASS	GUITAR/BASS, MIC, LINE, SIMUL (*3)
Recording Mode	REC MODE	INPUT	INPUT, BOUNCE, MASTERING (*3)
PAN	PAN	C00	L50-C00-R50

Chorus / Delay / Doubling

Parameter Name	Display	Initial Value	Valid Settings
Effect Type	FX Type	CHORUS	CHORUS, DELAY, DBLN

Chorus

Chorus Send Level	Send	In,Tr1-Tr6, Tr78: 0, Rhy: 0	0-100
Rate	Rate	10	0-100
Depth	Depth	10	0-100
Pre Delay	Pre Dly	10.0 ms	0.5-50.0 ms
Effect level	E.Level	100	0-100

Delay

Delay Send Level	Send	In,Tr1-Tr6, Tr78: 0, Rhy: 0	0-100
Delay Time	Dly Tme	370 ms	10-1000 ms
Feedback	Feedback	30	0-100
Effect Level	E.Level	30	0-100
Reverb Send	Rev Send	50	0-100

Doubling

Doubling Send Level	Send	In,Tr1-Tr6, Tr78: 0, Rhy: 0	0-100
Delay Time	Dly Tme	20.0 ms	0.5-50.0 ms
Effect level	E.Level	100	0-100

Reverb

Parameter Name	Display	Initial Value	Valid Settings
Reverb Send level	Send	In,Tr1-Tr6, Tr78: 0, Rhy: 0	0-100
Reverb Type	Type	HALL	HALL, ROOM
Reverb Time	Rev Time	2.0 s	0.1-10.0 s
Tone	Tone	0	-12-0+12
Effect Level	E.Level	50	0-100

Track EQ

Parameter Name	Display	Initial Value	Valid Settings
Equalizer On/Off	EQ	Tr1-6, 7/8: OFF	OFF, ON
Equalizer Low Gain	Lo G	Tr1-6, 7/8: 0 dB	-12-0+12 dB
Equalizer Low Frequency	Lo F	Tr1-6, 7/8: 100 Hz	40 Hz-1.5 kHz
Equalizer High Gain	Hi G	Tr1-6, 7/8: 0 dB	-12-0+12 dB
Equalizer High Frequency	Hi F	Tr1-6, 7/8: 1.0 kHz	500 Hz-18 kHz

Recorder Parameter (*1)

Parameter Name	Display	Initial Value	Valid Settings
Recording Track	-	-	Track 1–6, Track 1/2–7/8
V-Track	V-TRACK	1	1–8
Auto Punch On/Off	-	OFF	OFF, ON
Auto Punch In/Out	-	-	Any time
Locator	-	-	Any time
Repeat	-	-	Any time

* The settable range for Auto Punch In/Out, Locator and Repeat will change slightly depending on the MTC Type (sync parameter).

Song Parameter (*1)

Parameter Name	Display	Initial Value	Valid Settings
Song Name	SONG NAME	SONG0000	8 characters
Data Type	Type	HiFi (MT2)	HiFi (MT2), STD (LV1), LONG (LV2)
Song Protect	Protect SW	OFF	OFF, ON
Digital Copy Protect	Copy Prtct	OFF	OFF, ON

Phrase Trainer

Time Stretch	Time Strtch	OFF	OFF, ON (*3)
Center Cancel	CentrCncel	OFF	OFF, ON (*3)
Center cancel Low Boost	Low Boost	0	0–12 (*3)
Center cancel Adjust	C.Adjust	C00	L10–C00–R10 (*3)

System Parameter (*2)

Parameter Name	Display	Initial Value	Valid Settings
LCD Contrast	LCD Contrast	13	1–21
Foot Switch Assign	Foot SW	PLAY	PLAY, PUNCH, FX
Audio Sub Mix Switch	Sub Mixer	OFF	OFF, ON
Internal Mic On/Off Switch	Mic	EXTERNAL	EXTERNAL, ONBRD+EXT
Phantom Power Switch	Phantom SW	OFF	OFF, ON (*3)
AB Quantize	AB Qtz	OFF	OFF, ON
Remain Information	Remain Inf	OFF	OFF, ON
Power Save Mode	PowerSave	OFF	OFF, 1, 3, 5, 10 (min)
Calibrate (Tuner)	Calib	440	435–445 (Hz)

Sync Parameter (*2)

Parameter Name	Display	Initial Value	Valid Settings
Sync Generator	Sync Gen	OFF	OFF, MTC, MCK
MMC Master	MMC Master	OFF	OFF, ON
MTC Type	MTC Type	30	24, 25, 29D, 29N, 30
Rhythm MIDI Channel	RhyMIDI Ch	10	1–16, OFF
Offset	Offset	00:00:00-00.0	Any time

Parameter List

CD Parameter

Parameter Name	Display	Initial Value	Valid Settings
Pre Gap	Pre Gap	2.0 sec	0.0–3.4 sec (*3)

Scrub Parameter (*3)

Parameter Name	Display	Initial Value	Valid Settings
Scrub From/To Mode	From/To	FROM	FROM, TO
Preview Switch	Preview SW	OFF	OFF, ON











Rhythm Parameter (*1)

Parameter Name	Display	Initial Value	Valid Settings
Arrangement / Pattern / Off	-	OFF	OFF, ARRANGE, PATTERN
Arrangement	Arrangement Name	P01	P01–50, S01–05
Pattern	Pattern Name	P001	P001–327, S001–100
Rhythm Pad (*3)	-	OFF	UPPER, LOWER, OFF

Arrangement Parameter (*1)

Parameter Name	Display	Initial Value	Valid Settings
Step	current setting	1	1–50
Tempo	current setting	-	25.0–250.0
Starting Measure	current setting	001	001–999
Pattern	current setting	-	P001–327, S001–100
Drum Kit	Drum Kit	-	STD1, STD2, ROOM, HARD, JAZZ, HIP-HOP, HOUSE, REGGAE, 808, SongKit1–5

Pattern Parameter

Parameter Name	Display	Initial Value	Valid Settings
Measure (*1)	current setting	1	1–999
Time Signature (*1)	current setting	4/4	1/1–8/1, 1/2–8/2, 1/4–8/4, 1/8–8/8
Tempo (*3)	current setting	-	25.0–250.0
Quantize (*3)	current setting		         HI
Click (*3)	Click	3	0–3

Troubleshooting

If the BR-900CD does not function as you expect, please check the following points before assuming that a malfunction has occurred.

If this does not resolve the problem, contact a nearby Roland service center or your dealer.

Problems with the Sound

No sound

- Is the power of the BR-900CD and of the connected equipment turned on?
- Are the audio cables connected correctly?
- Are any audio cables broken?
- Has the volume of the connected amp or mixer been lowered?
- Has the MASTER fader or headphone volume of the BR-900CD been lowered?
- Is a memory card inserted?
- Has the wrong card been inserted?
You can use commercially available CompactFlash cards as memory cards for the BR-900CD; The 3.3 V type with the capacities of 32 MB to 1 GB can be used.
- Are you attempting to play back a short phrase of less than 1.0 seconds?
Phrases of 1.0 seconds or less cannot be played.

The volume level of the instrument connected to GUITAR/BASS jack or LINE IN jacks is too low

- Could you be using a connection cable that contains a resistor?
Use a connection cable that does not contain a resistor.

A specific track cannot be heard

- Has the track volume been lowered?
- Is the V-Track setting for a different V-Track?
- Has the track been muted?

The input source cannot be heard

- Did you adjust the SENS knob?
- Has INPUT SELECT been muted? (The INPUT SELECT indicator will be dark.)
- Has the INPUT LEVEL knob been set to "MIN"?
- If you are using the internal microphone, is "Mic" under UTILITY set to "ONBRD+EXT"?

Cannot record

- Is a song protected?
- Is a memory card inserted?
- Does the memory card have insufficient remaining capacity?
- Has the recording mode (REC MODE) been selected correctly?
- Has the Phrase Trainer or Scrub Playback function been turned on?

The recorded sound contains noise or distortion

- Is the input sensitivity set appropriately?
If the input sensitivity is too high, the recorded sound will be distorted. If it is too low, the input sound will be buried in noise. Adjust the SENS knob so that the level meter moves as much as possible without causing the PEAK indicator to light.
** Set it so the "0" is not indicated in the level meter.*
- Are the track output levels appropriate?
If you hear noise or distortion after bouncing tracks, the output level of the tracks was too high.
- Is a mic with high output impedance connected directly to the BR-900CD?
The BR-900CD is designed with a wide margin of headroom. Also, since the MIC 1 and MIC 2 jacks are low impedance inputs, the recording level may be too low, depending on the response of some mics. In such cases, connect the mic via a mic preamp to the LINE IN jacks on the BR-900CD before recording.

Cannot digitally record to an external device

- Does the sampling rate of the BR-900CD match that of the digital audio device?
Set the digital audio device to a sampling rate of 44.1 kHz.
- Does the digital signal format match?
Your digital audio device may use a non-standard digital signal format. Connect the BR-900CD to a digital audio device that supports CP-1201 or S/P DIF.

Problems with the Memory Card

“Unsupported Card!” is displayed

- Do you have a compatible (CompactFlash) memory card inserted in the BR-900CD?
- Is the memory card fully and securely inserted?

Memory card data was damaged

If memory card data has been damaged, the following causes are possible. Please initialize the card once again (p. 196).

- Was the power turned off while the recorder was operating?
- Was a strong physical shock applied to the memory card?
- Could the power have been turned off while the memory card was being accessed?
- Was the card initialized on a PC or digital camera?

Problems with the CD-R/RW Drive

Cannot remove the CD-R/RW disc

- Is the power turned on?
The CD-R/RW disc cannot be removed unless the power is turned on.
- Is a screen for reading from, or writing to CD-R/RW discs showing in the display?
It is not possible to eject the disc when you're in a screen for reading/writing CD-R/RW discs. Press [EXIT] several times to return to the Play screen, then press the EJECT button again.

Cannot read from/write to CD-R/RW discs

- Is the BR-900CD in a level position?
- Was a strong physical shock applied to the CD-R/RW drive?
- Is the disc correctly placed in the CD-R/RW drive?
- Are you using the right type of CD-R/RW disc?
- Are you using a CD-R disc that has already been written to, or a CD-RW disc that may be too old?
- Is the CD-R/RW drive being “force ejected?”
Pressing a straightened paper clip or similar object into the emergency eject hole in the CD-R/RW drive's front side forces ejection of the CD-R/RW disc. However, the CD-R/RW drive may not operate correctly after this is done. Should this be the case, turn off the power, then turn it back on again.

Synchronization Problems

Cannot Synchronize

When using MTC to synchronize the BR-900CD with a MIDI sequencer, the BR-900CD must be the master device.

- Is the MIDI cable connected correctly?
- Is the MIDI cable broken?
- Has the sync generator been set to the desired synchronization procedure (MTC or MIDI Clock)? (p. 158)
- If you are synchronizing with MTC, has the other device been set to the same MTC type? (p. 158)
- Has the MIDI sequencer been set correctly?
- Is the MIDI sequencer ready to play back?
- Does the other device support the MMC commands of the BR-900CD?

Synchronization with the rhythm machine is lost

- Is the connected rhythm machine receiving Song Position Pointer?
Certain rhythm machines are unable to receive Song Position Pointer while in Pattern mode.
Check the MIDI implementation for the rhythm machine you are using.

Problems with USB

Idling screen not displayed

- Is the USB cable properly connected?
- Is your computer's operating system compatible with the BR-900CD?
Windows: Windows Me/2000/XP
Macintosh: Mac OS 9.1.x / 9.2.x or OS X

Error Messages

If you attempt an incorrect operation or if an operation could not be executed, the display will indicate an error message. Refer to this list and take the appropriate action.

Battery Low!

Cause: The batteries are depleted (6 x AA dry-cell batteries).

Solution: Replace the batteries as soon as possible (p. 23).

Blank Disc!

Cause: Disc in the CD-R/RW drive contains no data.

Solution: Load a CD-R/RW disc that has data written on it.

Cannot Edit! Quantize is Low!

Cause: During Step Recording of a pattern, the Quantize setting is too coarse, so multiple entries are appearing at the same point in the matrix.

Solution: Fine the Quantize setting (p. 130).

Cannot Edit! This is a Preset

Cause: Preset data is selected; you cannot edit this data.

Solution: Copy the song data and then edit that.

Cannot Erase!

Cause: No further steps can be erased.

Solution: The Pitch Correction Map must contain a minimum of one step.

Cannot Insert!

Cause: No further steps can be inserted.

Solution: The Pitch Correction Map can contain a maximum of 99 steps.

Cannot Program! Rhythm Off.

Cause: The Rhythm is switched off, so you cannot program it.

Solution: Press [ARRANGE/PATTERN/OFF] to select Arrange mode or Pattern mode.

Cannot Punch In for CD-R/RW!

Cause: You cannot punch in when a CD is specified as the bounce destination.

Solution: If using the punch-in function, specify a track as the bounce destination.

Card Full!

Cause: It is not possible to record or copy due to small memory capacity.

Solution1: Back up the data you need to your computer (p. 164, p. 175), and delete unneeded data.

Solution2: Perform the Song Optimize operation (p. 78).

Card Read Error!

Cause: Memory card data cannot be loaded correctly.

Solution 1: Turn off the BR-900CD, properly insert the memory card, then turn the BR-900CD back on.

Solution 2: Initialize the card (p. 196).

* If the same message appears after you have taken the above steps, it is possible that the memory card is malfunctioning.

Card Write Error!

Cause: An error occurred while writing data to the memory card.

Solution: The memory card must be initialized (p. 196). Also, the song data you had been attempting to save will be lost.

CD Full!

Cause 1: The CD-R/RW disc is full, and no more data can be written to it.

Cause 2: When creating an audio CD, the total time of the tracks exceeds the capacity of the CD-R/RW disc.

Solution: Either reduce the amount of data to be written, or place a new CD-R/RW disc in the drive and start the procedure over again.

CD Medium Error!

Cause: There is a problem with the CD-R/RW disc. Alternatively, the disc on the CD-R/RW drive is unreadable.

Solution 1: Confirm that the correct type of disc is placed in the CD-R/RW drive.

Solution 2: Use a new CD-R/RW disc.

CD Read Error!

Cause: An error occurred while reading data from the CD-R/RW disc.

Solution: This may be due to a low-quality or dated disc. Try using a new CD-R/RW disc.

CD Write Error!

Cause: An error occurred while writing data to the CD-R/RW disc.

Solution: This may be due to a low-quality or dated disc. Try using a new CD-R/RW disc.

Data Too Short!

Cause: You have attempted to import a WAV/AIFF file shorter than one second or to load a WAV/AIFF file shorter than 0.1 seconds using the Tone Load function.

Solution: Make sure the WAV/AIFF file to be loaded is at least one second in length, or if using the Tone Load function, select a WAV/AIFF file that is at least 0.1 seconds in length.

Cause: You attempted to write an audio CD with a track that is less than four seconds in length.

Solution: Prepare tracks being written to audio CDs so that they are at least four seconds long.

Disc Not Ready!

Cause: There is no CD-R/RW disc in the drive.

Solution: Place a CD-R/RW disc in the drive.

Drive Busy!

Cause: If this message appears after you have been using the memory card with the BR-900CD, the data on the card has become fragmented, causing delays in reading and writing data.

Or, you could be using memory card with a slow processing speed.

* In cases of unfavorable disc access conditions, such as when track editing, punch-in/out recording, etc. is used to connect phrases (musical data) of several seconds.

Solution 1: Reduce the number of tracks that are played back simultaneously. Use track bouncing etc. to combine tracks, or erase data from tracks which you do not need to playback, and then try the playback again.

Solution 2: Reduce the number of tracks that are being recorded simultaneously.

Solution 3: Reduce the Data Type (STD (LV1) or LONG (LV2)), and then try creating the song again.

Cause: There is a problem with the CD-R/RW disc, preventing audio playback.

Solution: If the disc is dirty, wipe the disc to clean it, then try playing the disc again.

Event Full!

Cause: The BR-900CD has used up all the events that can be handled by one song.

Solution: Perform the Song Optimize operation (p. 78).

What is an event?

The smallest unit of memory used by the BR-900CD to store recorded results on a memory card is the event. A newly created song provides approximately 2,000 events per song. For each track, one recording pass uses two events. Operations such as punch-in/out or track copy also use up events. The number of events that are used up will fluctuate in a complex way.

Even if there is capacity remaining on the memory card, further recording or track editing will not be possible if all of the events are used up. In such cases, an error message such as "Event Full" will appear.

Finalized Disc!

Cause: Data has already been written to the CD-R/RW disc, and the data has been finalized.

Solution: Place a CD-R/RW disc that has not been finalized in the drive.

Turn Off Pitch Correction!

Cause: You cannot use the loop effects or phrase trainer while Pitch Correction is on.

Solution: Press [PITCH CORRECTION] to turn it off, and try the operation once again.

Memory Full!

Cause: The total time of the drum sounds for one drum kit that can be loaded with tone load has exceeded 13 seconds.

Solution: Make sure the drum sounds being loaded by means of tone load do not exceed a total of 13 seconds (p. 135, p. 171, p. 181).

Cause: No rhythm pattern memory remaining.

Solution 1: Delete any unneeded rhythm patterns (p. 133).

Solution 2: Delete any unneeded drum sounds in the rhythm patterns (p. 129, p. 132).

Cause: You have attempted to import an SMF that exceeds the available memory for imported files.

Solution: Delete any unneeded rhythm patterns (p. 133).

MIDI Buffer Full!

Cause: Excessive number of MIDI messages being output.

Solution 1: Either decrease the tempo of the Rhythm or reduce the number of Note messages (p. 123, p. 126).

Solution 2: Set the RhyMIDI ch to "OFF" (p. 157).

No Card!

Cause: You have tried to operate the recorder, or access the memory while the memory card (CompactFlash) is not inserted, or is not inserted properly.

Cause: The memory card has been removed after selection of data on that memory card.

Solution: Turn off the BR-900CD, properly insert the memory card, then turn the BR-900CD back on.

No File!

Cause: The file you are trying to import with WAV/AIFF/SMF import or Tone Load was not found.

Solution: Have the file you want to import ready.

No Song!

Cause: There are no songs on the memory card.

Solution: Create a new song (p. 32).

Cause: Incorrect data is in the song folder, or the necessary data is not present.

Solution: Restore the data backed up on the computer to the BR-900CD. In this case, restore each "ROLAND" folder to the BR-900CD (p. 164, p. 175).

Not Available in Mastering Mode!

- Cause:** You cannot carry out this operation with "MASTERING" selected as the recording mode.
- Solution:** First press the [REC MODE] button to switch the recording mode to "INPUT" or "BOUNCE," then proceed with the operation.

Not Blank Disc!

- Cause:** The CD-R/RW disc already has data written to it.
- Solution:** Place a CD-R/RW disc with no data written to it (a blank disc) in the CD-R/RW drive.
If using a CD-RW disc, you can erase the data on the disc in order to create a blank disc (p. 153).

Not CD-RW Disc!

- Cause:** The disc is not a CD-R/RW disc, so the data cannot be erased.
- Solution:** Use a CD-RW disc.

Not Finalized Disc!

- Cause:** The disc cannot be played back properly because it has not been finalized.
- Solution:** Finalize the disc (p. 143).

Power Down!

- Cause:** Internal power source voltage is below than guaranteed workable range.
- Solution:** In case of using PSC adaptor:
Cable might be broken or adaptor itself might be malfunctioning. Please contact Roland Service or Roland authorized dealers.
In case of using batteries:
Please replace with new batteries (p. 23).

Protected!

- Cause:** You are attempting to write data to a song that has protection switched on.
- Solution:** To write data to the song, switch Protect to OFF (p. 79).

Set Bounce Target to Track!

- Cause:** You cannot use the Rhythm-related functions (switching Arrangement/Pattern/Off, editing, switching Rhythm pads, Tone Load) when a CD is specified as the bounce destination.
- Solution:** When using Rhythms, specify a track as the bounce destination.

Set the Repeat!

- Cause:** Repeat A (Starting Point) and B (Ending Point) is not set.
- Solution:** Set the Repeat A and B (p. 51).

Stop P.Trainer!

- Cause:** The operation you attempted cannot be done while the Phrase Trainer (p. 192) is operating.
- Solution:** Press [PHRASE TRAINER] to turn off the Phrase Trainer.

Stop Recorder!

- Cause:** The operation you attempted cannot be done while the recorder is running (playing or recording).
- Solution:** Press [STOP] to stop playback or recording.

Too Many Songs!

- Cause:** You are attempting to create more than 100 songs.
- Solution:** Erase unneeded songs (p. 77).

Unformatted!

- Cause:** The Memory card is not formatted by DOS.
- Solution 1:** Turn off the BR-900CD, properly insert the memory card, then turn the BR-900CD back on.
- Solution 2:** Initialize the card (p. 196).

Unsupported Card!

- Cause:** The memory card (CompactFlash) or MicroDrive inserted is not compatible with the BR-900CD.
- Solution:** Use a memory card compatible with the BR-900CD (32 MB to 1 GB CompactFlash with a power-source voltage of 3.3 V).

Unsupported Format!

- Cause 1:** The BR-900CD cannot recognize or use the format of the inserted memory card.
- Solution 1:** Insert a memory card initialized for use with the BR-900CD (p. 196).
- Cause 2:** You have attempted to load an incompatible WAV or AIFF file or SMF to the BR-900CD.
- Solution 2:** Check the format of the WAV or AIFF file or SMF.

Use AC Adaptor!

- Cause:** You have attempted to use the CD-R/RW drive while running on battery power.
- Solution:** You cannot use the CD-R/RW drive while the BR-900CD is powered by the batteries. If you want to use the CD-R/RW drive, first save the song, turn off the power to the BR-900CD, connect the AC adaptor, then turn the power back on.

Wrong Disc!

- Cause:** A disc other than the required CD-R/RW disc is placed in the drive.
- Solution:** Place a CD-R/RW disc in the drive.

MIDI Implementation

1. TRANSMITTED DATA

* This message is transmitted according to a SMF data regardless of the followings when the data is played.

■Channel Voice Message

●Note On

If the MIDI parameter "RhyMIDI ch" is set to "1-16," note numbers/velocities corresponding to the Rhythm pattern will be transmitted on the MIDI channel that is specified for the Rhythm.

Status	Second	Third
9nH	mmH	llH
n = MIDI Channel No.:	0H - FH (ch.1 - ch.16)	
mm = Note No.:	00H - 7FH (0 - 127)	
ll = Velocity:	01H - 7FH (1 - 127)	

●Note Off

If the MIDI parameter "RhyMIDI ch" is set to "1-16," note numbers corresponding to the Rhythm pattern will be transmitted on the MIDI channel specified for the Rhythm.

Status	Second	Third
8nH	mmH	llH
n = MIDI Channel No.:	0H - FH (ch.1 - ch.16)	
mm = Note No.:	00H - 7FH (0 - 127)	
ll = Velocity:	40H (64)	

○Notes sounded by the Rhythm correspond to note numbers as follows.

Rhythm Tone	Note Number
Cross Stick	G 1 (31)
Metronome (click)	A 1 (33)
Metronome (bell)	A#1 (34)
Kick	C 2 (36)
Snare	D 2 (38)
Tom 4	F 2 (41)
Closed hi-hat	F#2 (42)
Tom 3	A 2 (45)
Open hi-hat	A#2 (46)
Tom 2	C 3 (48)
Crash cymbal	C#3 (49)
Tom 1	D 3 (50)
Ride cymbal	D#3 (51)
Cowbell	G#3 (56)

■System Common Messages

●MIDI Time Code Quarter Frame Messages

If the Sync parameter "Sync Gen" is set to "MTC," quarter frame messages of the time code type specified by "MTC Type" will be transmitted when the BR-900CD is running (recording or playing). The transmitted time counts are summed to "SMPTE (MTC) Offset Time" as the song top is "00:00:00:00".

Status	Second
F1H	mmH (= 0nnndddd)

nnn = Message type:	0 = Frame count LS nibble
	1 = Frame count MS nibble
	2 = Seconds count LS nibble
	3 = Seconds count MS nibble
	4 = Minutes count LS nibble
	5 = Minutes count MS nibble
	6 = Hours count LS nibble
	7 = Hours count MS nibble
dddd = 4 bit nibble data:	0h - FH (0 - 15)

Bit Field is assigned as follows.

Frame Count	xxxxxyyy	Reserved (000)
	xxx	Frame No. (0-29)
	yyyyy	
Seconds Count	xxxxxyyy	Reserved (00)
	xx	Seconds (0-59)
	yyyyyy	
Minutes Count	xxxxxyyy	Reserved (00)
	xx	Minutes (0-59)
	yyyyyy	
Hours Count	xyyzzzzz	Reserved (0)
	x	Time Code type
	yy	

* The time code types defined by the MIDI specification correspond to the BR-900CD Sync parameter "MTC Type" as follows.

MIDI specification setting	"MTC Type" setting
0 = 24 Frames/Sec	24
1 = 25 Frames/Sec	25
2 = 30 Frames/Sec (Drop Frame)	29D
3 = 30 Frames/Sec (Non Drop Frame)	29N or 30
zzzzz Hours (0-23)	

●Song Position Pointer

The current position is transmitted by the Song Position Pointer Message when the BR-900CD is stopped, or the locate operation has been performed, if the SYNC parameter "Sync Gen" is set to "MCK."

Status	Second	Third
F2H	mmH	nnH

mm (LSB), nn (MSB) = Song Position Point: 00H 00H - 7FH 7FH

■System Realtime Message

Transmitted when "Sync Gen" is "MCK" in the SYNC parameter.

●Timing Clock

Status
F8H

●Active Sensing

Status
FEH

* This is transmitted at intervals of approximately 200 msec.

●Start

Status
FAH

●Continue

Status
FBH

●Stop

Status
FCH

■ System Exclusive Message

<u>Status</u>	<u>Data Bytes</u>	<u>Status</u>
F0H	iiH, ddH, ..., eeH	F7H
<u>Byte</u>	<u>Description</u>	
F0H	Status of Exclusive Message	
iiH	ID Number	
	7EH Universal Non Realtime Message	
	7FH Universal Realtime Message	
ddH	Data: 00H - 7FH (0-127)	
:	:	
eeH	Data	
F7H	EOX (End of Exclusive Message)	

* The BR-900CD can transmit and receive Universal System Exclusive messages.

● Universal System Exclusive Message

○ MIDI Machine Control Commands

<u>Status</u>	<u>Data Bytes</u>	<u>Status</u>
F0H	7FH, Dev, 06H, aaH, ..., bbH	F7H
<u>Byte</u>	<u>Description</u>	
F0H	Status of Exclusive Message	
7FH	Universal System Exclusive Message Realtime Header	
Dev	Device ID (7FH)	
06H	MMC Command Message	
aaH	Command	
:	:	
bbH	Command	
F7H	EOX (End of Exclusive Message)	

* see '2. MIDI Machine Control' section

● MIDI Time Code Commands

○ Full Message

Basic operation of quarter frame messages will be handled.

<u>Status</u>	<u>Data Bytes</u>	<u>Status</u>
F0H	7FH, Dev, 01H, 01H, hrH, mnH, scH, frH	F7H
<u>Byte</u>	<u>Description</u>	
F0H	Status of Exclusive Message	
7FH	Universal System Exclusive Message Realtime Header	
Dev	Device ID (7FH)	
01H	sub-ID #1 (MIDI Time Code)	
01H	sub-ID #2 (MIDI Full Message)	
hrH	Hours and Type 0 yy zzzz	
	yy type	
	00 = 24 Frames/sec	
	01 = 25 Frames/sec	
	10 = 30 Frames/sec (Drop Format)	
	11 = 30 Frames/sec (Non Drop Format)	
	zzzz hours (00-23)	
mnH	Minutes (00-59)	
mnH	Seconds (00-59)	
frH	Frames (00-29)	
F7H	EOX (End of Exclusive Message)	

* When you change the song position, the device ID will be transmitted as 7FH.

----- About Device ID

Exclusive messages are not assigned to any particular MIDI channel. Instead, they have their own special control parameter called device ID. The Roland exclusive messages use device IDs to specify various devices.
BR-900CD transmits 7FH as the device ID.

2. MIDI Machine Control

■ MIDI Machine Control Command Reference

● STOP (MCS)

<u>Status</u>	<u>Data Bytes</u>	<u>Status</u>
F0H	7FH, Dev, 06H, 01H	F7H

<u>Byte</u>	<u>Description</u>
F0H	Status of Exclusive Message
7FH	Universal System Exclusive Message Realtime Header
Dev	Device ID (7FH)
06H	MMC Command Message
01H	STOP (MCS)
F7H	EOX (End of Exclusive Message)

* If the transport switch [STOP] was pressed, the BR-900CD transmits this message.

● DEFERRED PLAY (MCS)

<u>Status</u>	<u>Data Bytes</u>	<u>Status</u>
F0H	7FH, Dev, 06H, 03H	F7H

<u>Byte</u>	<u>Description</u>
F0H	Status of Exclusive Message
7FH	Universal System Exclusive Message Realtime Header
Dev	Device ID (7FH)
06H	MMC Command Message
03H	DEFERRED PLAY (MCS)
F7H	EOX (End of Exclusive Message)

* If the transport switch [PLAY] was pressed, the BR-900CD transmits this message.

● RECORD STROBE

<u>Status</u>	<u>Data Bytes</u>	<u>Status</u>
F0H	7FH, Dev, 06H, 06H	F7H

<u>Byte</u>	<u>Description</u>
F0H	Status of Exclusive Message
7FH	Universal System Exclusive Message Realtime Header
Dev	Device ID (7FH)
06H	MMC Command Message
06H	RECORD STROBE
F7H	EOX (End of Exclusive Message)

* Transmitted when recording to the audio tracks begins.

● RECORD EXIT

<u>Status</u>	<u>Data Bytes</u>	<u>Status</u>
F0H	7FH, Dev, 06H, 07H	F7H

<u>Byte</u>	<u>Description</u>
F0H	Status of Exclusive Message
7FH	Universal System Exclusive Message Realtime Header
Dev	Device ID (7FH)
06H	MMC Command Message
07H	RECORD EXIT
F7H	EOX (End of Exclusive Message)

* Transmitted when recording to the audio tracks ends.

● MMC RESET

<u>Status</u>	<u>Data Bytes</u>	<u>Status</u>
F0H	7FH, Dev, 06H, 0DH	F7H

<u>Byte</u>	<u>Description</u>
F0H	Status of Exclusive Message
7FH	Universal System Exclusive Message Realtime Header
Dev	Device ID (7FH)
06H	MMC Command Message
0DH	MMC RESET
F7H	EOX (End of Exclusive Message)

* When powered on the BR-900CD transmits this message.

MIDI Implementation

●LOCATE (MCP)

○Format 2 - LOCATE [TARGET]

Status	Data Bytes	Status
F0H	7FH, Dev, 06H, 44H, 06H, 01H, hrH, mnH, scH, frH, ffH	F7H

Byte	Description
F0H	Status of Exclusive Message
7FH	Universal System Exclusive Message Realtime Header
Dev	Device ID (7FH)
06H	MMC Command Message
44H	LOCATE(MCP)
06H	Number of Bytes
01H	"TARGET" sub command
	hrH, mnH, scH, frH, ffH
	Standard Time with Sub Frame
F7H	EOX (End of Exclusive Message)

* This message is transmitted when the song position moves.

<Example 1>

What is the decimal equivalent of 5AH?

From the above table, 5AH = 90.

<Example 2>

What is the decimal equivalent of the 7-bit hexadecimal values 12 34H?

From the above table, 12H = 18 and 34H = 52

Thus, 18 x 128 + 52 = 2356

<Example 3>

What is the decimal equivalent of the nibbled expression 0A 03 09 0DH?

From the above table, 0AH = 10, 03H = 3, 09H = 9, 0DH = 13

Thus, the result is ((10 x 16 + 3) x 16 + 9) x 16 + 13 = 41885

<Example 4>

What is the nibbled equivalent of the decimal number 1258?

16)	1258	
16)	78	...10
16)	4	...14
	0	... 4

From the above table, 0=00H, 4=04H, 14=0EH, 10=0AH

Thus the result is 00 04 0E 0AH

3. Supplementary material

●Decimal/Hexadecimal table

(hexadecimal values are indicated by a following "H")

MIDI uses 7-bit hexadecimal values to indicate data values and the address and size of exclusive messages. The following table shows the correspondence between decimal and hexadecimal numbers.

D	H	D	H	D	H	D	H
0	00H	32	20H	64	40H	96	60H
1	01H	33	21H	65	41H	97	61H
2	02H	34	22H	66	42H	98	62H
3	03H	35	23H	67	43H	99	63H
4	04H	36	24H	68	44H	100	64H
5	05H	37	25H	69	45H	101	65H
6	06H	38	26H	70	46H	102	66H
7	07H	39	27H	71	47H	103	67H
8	08H	40	28H	72	48H	104	68H
9	09H	41	29H	73	49H	105	69H
10	0AH	42	2AH	74	4AH	106	6AH
11	0BH	43	2BH	75	4BH	107	6BH
12	0CH	44	2CH	76	4CH	108	6CH
13	0DH	45	2DH	77	4DH	109	6DH
14	0EH	46	2EH	78	4EH	110	6EH
15	0FH	47	2FH	79	4FH	111	6FH
16	10H	48	30H	80	50H	112	70H
17	11H	49	31H	81	51H	113	71H
18	12H	50	32H	82	52H	114	72H
19	13H	51	33H	83	53H	115	73H
20	14H	52	34H	84	54H	116	74H
21	15H	53	35H	85	55H	117	75H
22	16H	54	36H	86	56H	118	76H
23	17H	55	37H	87	57H	119	77H
24	18H	56	38H	88	58H	120	78H
25	19H	57	39H	89	59H	121	79H
26	1AH	58	3AH	90	5AH	122	7AH
27	1BH	59	3BH	91	5BH	123	7BH
28	1CH	60	3CH	92	5CH	124	7CH
29	1DH	61	3DH	93	5DH	125	7DH
30	1EH	62	3EH	94	5EH	126	7EH
31	1FH	63	3FH	95	5FH	127	7FH

D: decimal

H: hexadecimal

* Decimal expressions such as used for MIDI channel, Bank Select, and Program Change will be the value 1 greater than the decimal value given in the above table.

* Since each MIDI byte carries 7 significant data bits, each byte can express a maximum of 128 different values. Data for which higher resolution is required must be transmitted using two or more bytes. For example a value indicated as a two-byte value of aa bbH would have a value of aa x 128 + bb.

* For a signed number (+/-), 00H = -64, 40H = +/-0, and 7FH = +63. I.e., the decimal equivalent will be 64 less than the decimal value given in the above table. For a two-byte signed number, 00 00H = -8192, 40 00H = +/-0, and 7F 7FH = +8191. For example the decimal expression of aa bbH would be aa bbH - 40 00H = (aa x 128 + bb - 64 x 128).

* Hexadecimal notation in two 4-bit units is used for data indicated as 'nibbled'. The nibbled two-byte value of 0a 0b H would be a x 16 + b.

■MIDI Machine Control (MMC) Command, Information Field / Response Reference

●Commands Transmitted

Command	Action
01H STOP	STOP
03H DEFERRED PLAY	PLAY
06H RECORD STROBE	REC / PUNCH IN
07H RECORD EXIT	PUNCH OUT
0DH MMC RESET	RESET
44H 01H LOCATE TARGET	LOCATE

MIDI Implementation Chart

DIGITAL RECORDING STUDIO

Date : Jan. 11, 2005

Model BR-900CD

MIDI Implementation Chart

Version : 1.00

Function...	Transmitted	Recognized	Remarks
Basic Channel	Default	1-16 * 1	X
	Changed	1-16 * 1	*****
Mode	Default	Mode 3	X
	Messages Altered	X *****	X X
Note Number :	True Voice	31, 33, 34, 36, 38, 41, 42, 45, 46, 48-51, 56 * 1 *****	X
Velocity	Note ON Note OFF	O 9n V=1-127 * 1	X
		O 8n V=64 * 1	X
		V=1-127 * 4	
After Touch	Key's Ch's	O * 4	X
		O * 4	X
Pitch Bend		O * 4	X
Control Change		O * 4	X
Prog Change : True #		O * 4 *****	X *****
System Exclusive		O	X
System Common	: Quarter Frame	O * 2	X
	: Song Pos	O * 3	X
	: Song Sel	X	X
	: Tune	X	X
System Real Time	: Clock	O * 3	X
	: Command	O * 3	X
Aux Message	: All sound off	X	X
	: Reset all controllers	X	X
	: Local ON/OFF	X	X
	: All Notes OFF	X	X
	: Active Sense	O	X
	: System Reset	X	X
Notes	* 1 Rhythm only. * 2 "SYNC parameter: Sync Gen = MTC" only. * 3 "SYNC parameter: Sync Gen = MCK" only. * 4 Transmitted according to SMF data when the data is played back.		

Mode 1 : OMNI ON, POLY

Mode 2 : OMNI ON, MONO

O : Yes

Mode 3 : OMNI OFF, POLY

Mode 4 : OMNI OFF, MONO

X : No

Specifications

BR-900CD: Digital Recording Studio

● Tracks

Track: 8

V-Track: 64 (8 V-Tracks per each Track)

* Up to 2 tracks can be recorded simultaneously, and up to 8 tracks can be played back simultaneously.

● Useful Capacity

CompactFlash: 32 M–1 G bytes

● Data Type

HiFi (MT2)

STANDARD (LV1)

LONG (LV2)

● Signal Processing

AD Conversion: 24 bit, $\Delta\Sigma$ Modulation + AF-AD (Guitar/Bass)

24 bit, $\Delta\Sigma$ Modulation + AF-AD (Mic 1/2)

24 bit, $\Delta\Sigma$ Modulation (Line)

24 bit, $\Delta\Sigma$ Modulation (Simul)

DA Conversion: 24 bit, $\Delta\Sigma$ Modulation

Internal Processing: 24 bit (digital mixer section)

* **AF method (Adaptive Focus method)**

Adaptive Focus is a unique Roland/BOSS technology that allows the signal noise (S/N) ratios of AD and DA converters to be vastly improved.

● Sample Rate

44.1 kHz

● Frequency Response

20 Hz to 20 kHz (+1/-3 dBu)

● Recording Time (conversion in one track)

Capacity	Data type		
	HiFi (MT2)	STD (LV1)	LONG (LV2)
32 MB	16 min.	19 min.	24 min.
64 MB	32 min.	39 min.	49 min.
128 MB	65 min.	78 min.	98 min.
256 MB	130 min.	156 min.	196 min.
512 MB	260 min.	312 min.	392 min.
1 GB	520 min.	624 min.	784 min.

* The above-listed recording times are approximate. Times may be slightly shorter depending on the number of songs that were created.

* The above number is the total for all the tracks that are used. If each of the eight tracks contain an equal amount of data, the length of the resulting song will be approximately 1/8 of the above.

● Nominal Input Level (Variable)

GUITAR/BASS jack: -20 dBu

MIC (TRS balanced/XLR) jack: -40 dBu

LINE IN jack: -10 dBu

● Input Impedance

GUITAR/BASS jack: 1 M Ω

MIC 1/2 jack: 1.5 k Ω (HOT-COLD)

(TRS balanced/XLR) 1.0 k Ω (HOT-GND, COLD-GND)

LINE IN jack: 10 k Ω

● Nominal Output Level

LINE OUT jack: -10 dBu

● Output Impedance

LINE OUT jack: 2 k Ω

Headphone jack: 140 Ω

● Recommended Load Impedance

LINE OUT jack: 20 k Ω or greater

Headphone jack: 32–100 Ω

● Residual Noise Level

LINE OUT jack: -85 dBu or less

(INPUT SELECT: GUITAR/BASS/MIC2, input terminated with 1 k Ω , INPUT SENS: CENTER, IHF-A, typ., EFFECT: OFF)

* 0 dBu = 0.775 Vrms

● Interface

USB Connector

DIGITAL OUT: S/PDIF 16–24 bit (Optical type)

● Display

16 Characters x 2 Lines + Approx. 100 icons (Backlit LCD)

● Connectors

GUITAR/BASS jack (1/4 inch phone type)

MIC 1 jacks (XLR balanced type, TRS balanced 1/4 inch phone type)

MIC 2 jacks (XLR balanced type)

LINE IN jack (RCA Phono type)

LINE OUT jack (RCA Phono type)

DIGITAL OUT connector (Optical type)

FOOT SW/EXP PEDAL jack (1/4 inch phone type)

PHONES jack (Stereo 1/4 inch phone type)

MIDI OUT connector

USB connector

● Power Supply

DC 9 V; Supply AC Adaptor (PSC series), Dry battery x 6

● Current Draw

900 mA (Average using AC adapter and CD-R/RW)

300 mA (When powered by batteries; CD-R/RW drive not used)

* *Expected battery life under continuous use:*

Alkaline: 4 hours

These figures will vary depending on the actual conditions of use.

● Dimensions

351 (W) x 225 (D) x 69 (H) mm

13-7/8 (W) x 8-7/8 (D) x 2-3/4 (H) inches

● Weight

2.2 kg/4 lbs 14 oz (excluding batteries)

● Accessories

AC Adaptor (PSC-series)

Demo Card (Already inserted when the BR-900CD is shipped)

Owner's Manual

Separate sheet ("About Memory Cards" etc.)

Roland Service (information sheet)

● Options

Foot Switch: FS-5U

Pedal Switch: DP-2 (Roland)

Expression Pedal: EV-5 (Roland), FV-300L

NOTE

In the interest of product improvement, the specifications and/or appearance of this unit are subject to change without prior notice.

Index

Symbols

+ 69, 72, 75

Numerics

24 159, 199
25 159, 199
29D 158, 199
29N 158, 199
30 158, 199

A

AB Qtz 52, 198
AC 99
AC Adaptor 22, 26
Access indicator 21
ACOUSTIC GTR 89
Acoustic Guitar Simulator 93
Acoustic Processor 93
ACOUSTIC SIM 88
AIFF 165, 176
Algorithm 35, 88, 105
ALL 72, 75, 137, 146–147, 194
All Backup 146
All Recover 147
AMG 99
ARRANGE 37
[ARRANGE/PATTERN/OFF] 37, 121, 123, 126, 130, 134
Arrangement 37, 120–121
Arrangement Mode 37, 120
Arrangement Name 124
Attack 94–95, 107
Attack Time 94
AUDIO 140
Audio CD menu screen 140
Audio CD player screen 142
Audio CD Write screen 141
Audio Sub Mix 190
AUTO PUNCH [IN] 54
AUTO PUNCH [ON/OFF] 55
AUTO PUNCH [OUT] 54
Auto Punching In/Out 54

B

BACKUP 145–146, 164, 175
Backup 145, 164, 175

BANK

GUITAR 88
LINE 91
MIC 90
SIMUL 92
Bank 35, 84
Bass 99
Bass Cut Filter 106
BASS MULTI 89
BASS SIM 89
Bass Simulator 93
Battery 23, 197
Battery Cover 23
Battery Low! 23
BG LEAD 98
Bit 97
BLUES 98
Body 93
BOSS-Cmp 94
BOUNCE 40, 45, 58
Bounce 58
Bouncing 45
 Input source 60
 To a CD-R/RW Disc 59
BPF 97
BR0 Folder 162
BR-532 61, 173, 183
BR-864 61, 173, 183
Bright 99

C

C.Adjust 193
Calib 189
Calibrate 189
CARD 172, 182, 196
Card Cover 16
Card Protector 16
CD menu screen 140
[CD-R/RW] 140, 145
CD-R/RW disc 6
 Compatibility 6
 Inserting 7
 Precautions 6
 Removing 7
CD-R/RW Drive 6, 140, 145
CD-R/RW Write 154
CD-RW Erase 153
Center Cancel 192
CentrCncel 192
Charct 93

- CHO/DLY 43–44, 108–109
 CHORUS 44, 108, 111
 Chorus 94, 108
 Chromatic Tuner 188
 CLEAN 98
 Click 129
 CompactFlash 5, 16, 27, 31
 Compatible OS 162
 Compressor 94, 107
 Condenser mic 7
 Condenser microphone 191
 Connecting 26, 33, 163
 Converting 165, 176
 COPY 125, 133, 137
 Copy Prtct 81
 Copying
 Arrangement 125
 Drum Kit 137
 Pattern 133
 Song 77
 Track 67–69
 Waveform data 148
 Copyright 154
 Cord Hook 22
 Correction Event Map 116
 Correction Event Map screen 116
 COSM 15
 COSM BASS AMP 90
 COSM COMP BSS 90
 COSM COMP GTR 89
 COSM COMP VCL 91
 COSM Comp/Limiter 94
 COSM GTR AMP 88
 CPY 67–68, 77
 Creating
 Arrangement 123
 Audio CD 140
 Drum Kit 135
 Pattern 126, 130
 CRUNCH 98
 Cutoff F 97
- D**
 DATA 145, 148
 Data CD menu screen 145
 Data type 32
 DBLN 44, 108, 111
 DC IN jack 22
 D-Comp 94
 D:E 96, 98
- De-esser 95
 Defretter 95
 DELAY 44, 108, 111
 Delay 95, 108
 [DELETE/MUTE] 41, 129, 132
 Deleting
 Drum sounds 129, 132
 Locator 64
 Demo Song 29
 Depth 94–97, 100, 111
 DETUNE 98
 DIGITAL 96
 Digital Copy 80
 Digital Copy Protect 80
 DIGITAL OUT connector 22
 Dir Level 97, 99–100
 Direct CD Bounce 59
 Disc tray 21
 Display 21
 Display Contrast 186
 Dither 107
 Dly Time 106
 Dly Tme 95, 111
 Doubling 44, 95, 108, 111
 DOWN 101
 Driver 162
 Drum Kit 134
 Drum sounds 149
 Dynamic microphone 191
- E**
 E 120
 E.Level 94–95, 111
 [EDIT] 123, 126, 130, 134
 EDIT 85, 103, 115
 Edit Effect screen 85
 Editing
 Insert effects 85
 Mastering Tool Kit 103
 Track 67
 EDT 78
 Effect Patch 35, 84–85, 202
 Effect screen 85
 [EFFECTS] 35, 85, 87
 Effects 35
 EJECT button 7, 21
 Emergency eject hole 7, 21
 Ending 120
 ENHANCE 93
 Enhancer 95, 106

EQ 43, 110
 Equalizer 43, 96, 105
 ERASE 124–125, 133, 138, 153
 Erasing
 Arrangement 125
 Data from a CD-RW 153
 Drum sounds 138
 Pattern 133
 Song 77
 Step 124
 Track 74–75
 ERS 73, 77
 Exchanging
 Track 76
 Expander 106
 EXPORT 150, 165, 176
 Expression Pedal 27, 187
 EXTERNAL 34
 External MIDI Device 190

F

F 120
 Feedback 95, 111
 [FF] 29, 66
 Fill 120
 Filter 96
 FINAL 144
 Finalize 141, 143
 Flanger 96
 Foot SW 54, 187, 198
 FOOT SW/EXP PEDAL 187
 FOOT SW/EXP PEDAL jack 22
 Foot Switch 27, 54, 187
 Foot Volume 96
 Formant1 100
 Formant2 100
 Formatting
 Memory card 31
 FRAME 21
 Freq 95, 106
 Frequency 99, 101
 FROM 199
 From/To 199
 FS-6 187
 FX 187
 Fx Level 97, 99
 FX Type 43, 108, 111
 FX1 Level 100
 FX2 Level 100

G

Gain 97, 99, 106
 GAP 140
 Ground terminal 23
 GTR 36, 85, 202
 GUITAR/BASS 33
 GUITAR/BASS jack 22
 [GUITAR/BASS/MIC2] 34, 39, 48, 84

H

HALL 44, 108, 111
 Headphones jack 20
 HI 127, 130
 Hi Attack 106–107
 Hi F 112
 Hi G 112
 Hi Gain 96
 Hi Level 107
 Hi Ratio 106–107
 Hi Release 106–107
 Hi Thres 106–107
 HIFEML 115
 HIMALE 115
 HiFi (MT2) 32, 62
 High Freq 105
 High Gain 105
 High Mid Freq 105
 High Mid Gain 105
 High Mid Q 105
 High Q 105
 High Type 105
 Hi-M F 96
 Hi-M Gin 96
 Hi-M Q 96
 HPF 97
 HUMBUCK 93

I

Idling screen 164, 175
 IMP 154
 IMPORT 148, 153, 167, 178
 Importing
 SMF 169, 179
 IN 35, 49, 120
 In Send 109
 INF 62, 94, 106
 INI 31, 194–196

- Initializing 194
 All 194
 Effect setting 195
 Memory card 31, 196
 Rhythm 195
 System setting 194
 INPUT 40, 50, 87
 Input 94, 106
 Input Gain 105
 INPUT LEVEL knob 35
 INPUT SELECT 39, 48
 INPUT SELECT button 34
 Input sensitivity 35
 INSERT 124
 Insert Effect 35–36, 84, 88
 Inserting
 Step 124
 Internal microphone 34
 Intro 120
 ISO9660 151
- J**
- JC-120 98
 JUMBO 93
- K**
- KIT 134
- L**
- LCD Contrast 186, 198
 Level 93–96, 99, 101, 107
 Level Meter 21, 35
 Limiter 107
 LIN 36, 203
 [LINE] 34, 39, 84
 LINE 33, 48
 LINE IN jacks 22
 LINE OUT jacks 22
 Lo Attack 106–107
 Lo F 112
 Lo G 112
 Lo Level 107
 Lo Mix Lvl 95
 Lo Ratio 106–107
 Lo Release 106–107
 Lo Thres 106–107
 LO.FEML 115
 LO.MALE 115
 LOAD 136
- Loading
 Drum pattern 152
 Drum sounds 171, 181
 Drum tones from the tracks 135
 Song from CD-R/RW disc 154
 Songs to memory card 147
 WAV/AIFF file 167, 178
 LOCAT 87, 114
 [LOCATOR] 64
 Locator 64
 Locator Point 64
 LO-FI BOX 91
 Lo-Fi Box 96
 Lo-M F 96
 Lo-M Gin 96
 Lo-M Q 96
 LONG (LV2) 32, 62
 Loop Effect 43, 108, 111
 [LOOP EFFECTS] 43, 108
 Loop Recording 56
 Low Boost 193
 Low Freq 105
 Low Gain 96, 105
 Low Mid Freq 105
 Low Mid Gain 105
 Low Mid Q 105
 Low Q 105
 Low Type 105
 LPF 97
 LR 35
- M**
- Mac OS 9.1.x 162
 Mac OS 9.2.x 162
 Mac OS X 162
 Macintosh 162, 175
 MANUAL 98
 Manual 96–97
 Manually Punching In/Out 53
 MASTER 87
 Master 99, 158
 MASTER fader 28, 35
 Master Tape/Disc 80
 MASTERING 40, 102
 Mastering 102
 Mastering screen 102
 Mastering Tool Kit 40, 102–105
 Mastering Tool Kit Patch 205
 MATCH 98
 Matrix 127, 131

MCK	158
MEAS	21
Measure	127, 130
MEMORY CARD	20
Memory Card.....	5, 16, 27, 31
Composition of data	162
Remaining memory	62
Saving memory	78
METAL	98
METAL D	98
Metronome	129
[MIC]	34, 39
MIC	20, 36, 48, 85, 203
Mic	7, 198
Mic Dist	93
Mic Level	100
Mic Select screen	34
Mic Set	100
MIC1	33
MIC1 jacks	22
MIC2	33
MIC2 jack	22
Microphone pre-amp	191
Mid Attack	106–107
Mid Level	107
Mid Ratio	106–107
Mid Release	106–107
Mid Thres	106–107
Middle	99
MIDI	156–157
MIDI channel	156
MIDI connector	156
MIDI Implementation Chart	156
MIDI IN	156
MIDI OUT	156
MIDI OUT connector	22
MIDI Sequencer	158
MIDI Sound Module	157
MIDI THRU	156
Mix Level	95
Mix Lvl	106
Mixer	107
MMC	160
MMC Master	160, 198
Mode	100
Modify Fil	97
Mono recording	39, 48, 59
MOV	71–72
Moving	30
To Locator	64
Track	70–72
MS	98
MTC	158–159
MTC Type	158, 199
MTK	205
Mute	41
N	
NAM	78
NAME	86, 104, 115, 124, 132
Naming	
Arrangement	124
Pattern	132
Song	78
NEW	33
Noise	96
Noise Suppressor	97
Note	116
O	
Oct Level	97
Octave	97
OFF	37
Offset	159, 199
On/Off	93–101, 105–107, 112
ONBRD+EXT	34
OPT	78
OS	162
Output	107
Output Gain	105
Overdubbing	41
P	
P.MAP	116
PAN	42, 49, 138
Pan	42, 49
Drum sounds	138
[PAN/EQ]	42–43, 49, 110
PAN-SQR	100
PAN-TRI	100
Patch	35
Patch Name	86, 104, 115
PATTERN	37
Pattern	37, 120, 122, 126, 169, 179
Pattern Mode	37, 120
Pattern Name	132

- Pattern Number 123
 PCR 205
 PEAK 105
 Peak 101
 PEAK indicator 35
 PEDAL 98, 101
 Phantom power 7, 191
 Phantom SW 191, 198
 Phaser 97
 [PHRASE TRAINER] 192
 Phrase Trainer 192
 PickUp 93
 PIEZO 93
 Pitch 98
 [PITCH CORRECTION] 114
 Pitch Correction 113–114
 Pitch Correction Edit 115
 Pitch Correction Patch 205
 Pitch Shifter 98
 [PLAY] 29, 143, 152
 PLAY 187
 Play Screen 28
 PLAY/IMP 142, 154
 Playback
 Audio CD 142
 Demo song 29
 Repeat 51
 PLAYER 96
 Playing
 SMF 151
 Polarity 101
 Post Fltr 97
 Power 28
 Power Save 197
 POWER switch 22, 28
 PowerSave 197–198
 Pre Dly 94, 111
 Pre Filter 97
 Preamp 98
 Pre-gap 140
 Presence 99
 Preset Arrangement 38, 120, 206
 Preset Drum Kit 134
 Preset Patch 36, 84, 113
 Preset Pattern 38, 120, 207
 Preview 65, 136, 148–149, 172, 182
 Preview SW 199
 Protecting
 Song 79
 PRT 79
 PUNCH 54, 187
 Punch-in/out 53
 Punching In 53
 Punching Out 53
 PVW 136, 148–149, 172, 182

Q
 Quantize 52, 127, 130

R
 Rack160 94
 RADIO 96
 Rate 94, 96–97, 100, 111
 Ratio 94
 REAL 126
 Realtime Recording 126
 [REC] 50, 53
 [REC MODE] 40, 45, 50
 REC MODE 21, 39, 58, 102
 REC TRACK 39, 41, 48
 REC TRACK buttons 127, 131, 134
 Recording 32, 48, 80
 Rhythm 121
 Track 39
 Recording Standby screen 123, 126
 Recording Time 32
 RECOVER 147
 Recover 147, 164, 175
 Recover menu screen 147
 Redo 57
 Reference Pitch 188–189
 Rehearse 128
 Release 97, 107
 Release Time 94
 REMAIN 142
 Remain Inf 62, 198
 Remaining available recording time 62
 Remaining time for recording on Audio CDs 142
 [REPEAT] 51
 Repeat 51–52
 Resonance 96–97
 REV 43–44, 108–109
 Rev Send 111
 Rev Time 111
 REVERB 111
 Reverb 108
 [REW] 29, 66
 RHR 128
 RHY 195

Rhy Send	109
RhyMIDI ch	157, 199
RHYTHM	35, 87
Rhythm	37, 120, 157
RHYTHM fader	37, 121–122
Rhythm Mode	121
[RHYTHM PAD]	127, 131, 134
Ring Modulator	99
RiseTme	99
ROLAND Folder	162
ROOM	44, 108, 111

S

S EFX	195
Saving	29, 79
Insert Effects	86
Mastering Tool Kit	104
Pitch Correction	115
To CD-R/RW disc	145
Track data in WAV/AIFF format	165, 176
SCMS	154
SCR	199
Scrub	65
SCRUB FROM	65
Scrub Parameter	199
Scrub Point	65
SCRUB TO	65
SEL	29
Send Level	44, 109
Sens	95, 101, 106
SENS knob	35
Separation	95–96, 98
SHELVG	105
Sibilant	95
[SIMUL]	34, 39, 48
SIMUL	85
SINGLE	93, 95
SLDN	98
Slow Attack	99
SMF	151–153, 169–170, 179
SMF Folder	162
SMF import	152
SMF player	151
SML	36, 204
Smooth	115
Smpl Rate	97
Smth	117
Soft Clip	107
SONG	145, 147
Song Arrangement	38, 120, 123
Song Backup	145
Song Copy	77
Song Drum Kit	134
Song Erase	77
Song Information	62
Song Name	78
Song New	32
Song Optimize	57, 78
Song Patch	36, 84, 113
Song Pattern	38, 120
Song Protect	79
Song Recover	147
Song Select	29
Song Select screen	29
Speaker Simulator	100
SplitH	106
SplitL	106
Starting Measure	123
STD	93
STD (LV1)	32, 62
STEP	123, 130
Step	123
Step Recording	126, 130
STEREO MULTI	91
Stereo recording	39, 48
Sub Mixer	190, 198
Sustain	94
SYNC	157–160, 198
Sync Gen	158, 160, 198
Sync Parameter	198
Synchronizing	157
SYS	194, 198
System Parameter	198

T

[TAP]	38, 122
TAP	95
TEMPO	21
Tempo	38, 122–123, 127, 130
Thres	107
Threshold	94, 97
TIME	21
Time between songs (Pre Gap)	140
Time Signature	123, 127, 130
Time Stretch	192
TimeStrtch	192
TME/MES	68, 71, 74
TMP	85
TO	199

TONE 149
 Tone 94, 111
 Tone Load 135, 149, 171, 181
 TONELOAD Folder 162
 Top-Hi 93
 Top-Mid 93
 TOUCH 101
 TRACK 87, 135
 Track 39, 41, 48
 Track At Once 140
 Track Copy 67
 Track Editing 67
 Track EQ 43, 110, 112
 Track Erase 73
 Track Exchange 76
 TRACK fader 18, 29
 TRACK MIXER 18
 Track Move 70
 Track Mute 41
 Treble 99
 Tremolo/Pan 100
 TRK 67, 70, 73, 75–76
 TRM-SQR 100
 TRM-TRI 100
 [TUNER] 188
 Tuner 188
 Tuning 96, 188–189
 Tuning guide 188
 Type 43, 94–96, 98, 100–101, 108, 111, 115

U

U EFX 195
 Undo 57
 [UNDO/REDO] 57
 UP 101
 USB 162, 164, 175
 USB connector 22
 USB Folder 163
 USB screen 164
 User Patch 36, 84
 [UTILITY] 198–199

V

V 120
 Velocity 127, 131–132
 Verse 120
 VO DRV 98
 VO+AC.SIM 92
 VO+ACOUSTIC 92

VO+GT AMP 92
 VOCAL MULTI 90
 VOICE TRANS 90
 Voice Transformer 100
 Volume 99
 VtgRack 94
 [V-TRACK] 49
 V-Track 14, 49
 V-Track Selection screen 49

W

Wah 101
 WAV 148, 150, 165, 176
 WAV/AIFF Export 150, 165, 176
 WAV/AIFF File 171, 181
 WAV/AIFF Import 148, 167, 178
 WAV/AIFF menu screen 148
 Windows 162, 164
 Windows 2000 162
 Windows Me 162
 Windows XP 162
 Wow Flt 96
 WRITE 86, 104, 115, 141
 Writing
 Insert effects 86
 Mastering Tool Kit 104
 Pitch Correction 115
 Audio CD 140
 Waveform data 148

X

XCG 76

Z

[ZERO] 30

For the U.K.

IMPORTANT: THE WIRES IN THIS MAINS LEAD ARE COLOURED IN ACCORDANCE WITH THE FOLLOWING CODE.

BLUE: NEUTRAL
BROWN: LIVE

As the colours of the wires in the mains lead of this apparatus may not correspond with the coloured markings identifying the terminals in your plug, proceed as follows:

The wire which is coloured BLUE must be connected to the terminal which is marked with the letter N or coloured BLACK.
The wire which is coloured BROWN must be connected to the terminal which is marked with the letter L or coloured RED.
Under no circumstances must either of the above wires be connected to the earth terminal of a three pin plug.

For EU Countries



This product complies with the requirements of European Directive 89/336/EEC.

For the USA

FEDERAL COMMUNICATIONS COMMISSION RADIO FREQUENCY INTERFERENCE STATEMENT

This equipment has been tested and found to comply with the limits for a Class B digital device, pursuant to Part 15 of the FCC Rules. These limits are designed to provide reasonable protection against harmful interference in a residential installation. This equipment generates, uses, and can radiate radio frequency energy and, if not installed and used in accordance with the instructions, may cause harmful interference to radio communications. However, there is no guarantee that interference will not occur in a particular installation. If this equipment does cause harmful interference to radio or television reception, which can be determined by turning the equipment off and on, the user is encouraged to try to correct the interference by one or more of the following measures:

- Reorient or relocate the receiving antenna.
- Increase the separation between the equipment and receiver.
- Connect the equipment into an outlet on a circuit different from that to which the receiver is connected.
- Consult the dealer or an experienced radio/TV technician for help.

This device complies with Part 15 of the FCC Rules. Operation is subject to the following two conditions:

- (1) This device may not cause harmful interference, and
- (2) This device must accept any interference received, including interference that may cause undesired operation.

Unauthorized changes or modification to this system can void the users authority to operate this equipment.
This equipment requires shielded interface cables in order to meet FCC class B Limit.

For Canada

NOTICE

This Class B digital apparatus meets all requirements of the Canadian Interference-Causing Equipment Regulations.

AVIS

Cet appareil numérique de la classe B respecte toutes les exigences du Règlement sur le matériel brouilleur du Canada.

For the USA

DECLARATION OF CONFORMITY Compliance Information Statement

Model Name : BR-900CD
Type of Equipment : Digital Recording Studio
Responsible Party : Roland Corporation U.S.
Address : 5100 S.Eastern Avenue, Los Angeles, CA 90040-2938
Telephone : (323) 890-3700

