

Classic Organ

C-280

**Owner's Manual**

**Roland®**

Roland®

Owner's Manual

C-280

Classic Organ



# Classic Organ

## C-280

Owner's Manual

**Roland®**

**Copyright © 1999 ROLAND CORPORATION**  
All rights reserved. No part of this publication may be reproduced in any form  
without the written permission of ROLAND CORPORATION.

	<b>CAUTION</b> RISK OF ELECTRIC SHOCK DO NOT OPEN	
<b>ATTENTION:</b> RISQUE DE CHOC ELECTRIQUE NE PAS OUVRIR		
<p><b>CAUTION:</b> TO REDUCE THE RISK OF ELECTRIC SHOCK, DO NOT REMOVE COVER (OR BACK). NO USER-SERVICEABLE PARTS INSIDE. REFER SERVICING TO QUALIFIED SERVICE PERSONNEL.</p>		



The lightning flash with arrowhead symbol, within an equilateral triangle, is intended to alert the user to the presence of uninsulated "dangerous voltage" within the product's enclosure that may be of sufficient magnitude to constitute a risk of electric shock to persons.



The exclamation point within an equilateral triangle is intended to alert the user to the presence of important operating and maintenance (servicing) instructions in the literature accompanying the product.

INSTRUCTIONS PERTAINING TO A RISK OF FIRE, ELECTRIC SHOCK, OR INJURY TO PERSONS.

## IMPORTANT SAFETY INSTRUCTIONS SAVE THESE INSTRUCTIONS

**WARNING** - When using electric products, basic precautions should always be followed, including the following:

- |  |   |
|--|---|
| <ol style="list-style-type: none"> <li>1. Read these instructions.</li> <li>2. Keep these instructions.</li> <li>3. Heed all warnings.</li> <li>4. Follow all instructions.</li> <li>5. Do not use this apparatus near water.</li> <li>6. Clean only with a damp cloth.</li> <li>7. Do not block any of the ventilation openings. Install in accordance with the manufacturers instructions.</li> <li>8. Do not install near any heat sources such as radiators, heat registers, stoves, or other apparatus (including amplifiers) that produce heat.</li> <li>9. Do not defeat the safety purpose of the polarized or grounding-type plug. A polarized plug has two blades with one wider than the other. A grounding type plug has two blades and a third grounding prong. The wide blade or the third prong are provided for your safety. When the provided plug does not fit into your outlet, consult an electrician for replacement of the obsolete outlet.</li> </ol> | <ol style="list-style-type: none"> <li>10. Protect the power cord from being walked on or pinched particularly at plugs, convenience receptacles, and the point where they exit from the apparatus.</li> <li>11. Only use attachments/accessories specified by the manufacturer.</li> <li>12. Use only with a cart, stand, tripod, bracket, or table specified by the manufacturer, or sold with the apparatus. When a cart is used, use caution when moving the cart/apparatus combination to avoid injury from tip-over.</li> <li>13. Unplug this apparatus during lightning storms or when unused for long periods of time.</li> <li>14. Refer all servicing to qualified service personnel. Servicing is required when the apparatus has been damaged in any way, such as power-supply cord or plug is damaged, liquid has been spilled or objects have fallen into the apparatus, the apparatus has been exposed to rain or moisture, does not operate normally, or has been dropped.</li> </ol> |
|--|---|



**For the USA**

This product may be equipped with a polarized line plug (one blade wider than the other) . This is a safety feature. If you are unable to insert the plug into the outlet, contact an electrician to replace your obsolete outlet. Do not defeat the safety purpose of the plug.

**For Canada**

For Polarized Line Plug

**CAUTION:** TO PREVENT ELECTRIC SHOCK, MATCH WIDE BLADE OF PLUG TO WIDE SLOT, FULLY INSERT.

**ATTENTION:** POUR ÉVITER LES CHOCS ÉLECTRIQUES, INTRODUIRE LA LAME LA PLUS LARGE DE LA FICHE DANS LA BORNE CORRESPONDANTE DE LA PRISE ET POUSSER JUSQU' AU FOND.

**For the U.K.**

**IMPORTANT:** THE WIRES IN THIS MAINS LEAD ARE COLOURED IN ACCORDANCE WITH THE FOLLOWING CODE.



BLUE: NEUTRAL  
BROWN: LIVE

As the colours of the wires in the mains lead of this apparatus may not correspond with the coloured markings identifying the terminals in your plug, proceed as follows:  
The wire which is coloured BLUE must be connected to the terminal which is marked with the letter N or coloured BLACK.  
The wire which is coloured BROWN must be connected to the terminal which is marked with the letter L or coloured RED.  
Under no circumstances must either of the above wires be connected to the earth terminal of a three pin plug.







# USING THE UNIT SAFELY

## INSTRUCTIONS FOR THE PREVENTION OF FIRE, ELECTRIC SHOCK, OR INJURY TO PERSONS

### About WARNING and CAUTION Notices









 <b>WARNING</b>	Used for instructions intended to alert the user to the risk of death or severe injury should the unit be used improperly.
 <b>CAUTION</b>	Used for instructions intended to alert the user to the risk of injury or material damage should the unit be used improperly. * Material damage refers to damage or other adverse effects caused with respect to the home and all its furnishings, as well to domestic animals or pets.

### About the Symbols









	The  symbol alerts the user to important instructions or warnings. The specific meaning of the symbol is determined by the design contained within the triangle. In the case of the symbol at left, it is used for general cautions, warnings, or alerts to danger.
	The  symbol alerts the user to items that must never be carried out (are forbidden). The specific thing that must not be done is indicated by the design contained within the circle. In the case of the symbol at left, it means that the unit must never be disassembled.
	The  symbol alerts the user to things that must be carried out. The specific thing that must be done is indicated by the design contained within the circle. In the case of the symbol at left, it means that the power-cord plug must be unplugged from the outlet.

### ALWAYS OBSERVE THE FOLLOWING

#### WARNING

- Before using this unit, make sure to read the instructions below, and the Owner's Manual. 
- Do not open or perform any internal modifications on the unit. 
- Make sure you always have the unit placed so it is level and sure to remain stable. Never place it on stands that could wobble, or on inclined surfaces. 
- Avoid damaging the power cord. Do not bend it excessively, step on it, place heavy objects on it, etc. A damaged cord can easily become a shock or fire hazard. Never use a power cord after it has been damaged. 
- In households with small children, an adult should provide supervision until the child is capable of following all the rules essential for the safe operation of the unit. 
- Protect the unit from strong impact. (Do not drop it!) 
- Do not force the unit's power-supply cord to share an outlet with an unreasonable number of other devices. Be especially careful when using extension cords—the total power used by all devices you have connected to the extension cord's outlet must never exceed the power rating (watts/amperes) for the extension cord. Excessive loads can cause the insulation on the cord to heat up and eventually melt through. 
- Before using the unit in a foreign country, consult with your retailer, the nearest Roland Service Center, or an authorized Roland distributor, as listed on the "Information" page. 

#### CAUTION

- Always grasp only the plug on the power-supply cord when plugging into, or unplugging from, an outlet or this unit. 
- Try to prevent cords and cables from becoming entangled. Also, all cords and cables should be placed so they are out of the reach of children. 
- Never climb on top of, nor place heavy objects on the unit. 
- Never handle the power cord or its plugs with wet hands when plugging into, or unplugging from, an outlet or this unit. 
- If you need to move the instrument, take note of the precautions listed below. At least two persons are required to safely lift and move the unit. It should be handled carefully, all the while keeping it level. Make sure to have a firm grip, to protect yourself from injury and the instrument from damage.
  - Disconnect the power cord.
  - Disconnect all cords coming from external devices.
  - Remove the music stand.
- Before cleaning the unit, turn off the power and unplug the power cord from the outlet (P. 12). 
- Whenever you suspect the possibility of lightning in your area, pull the plug on the power cord out of the outlet. 
- When using the bench, please observe the following points: 
  - Do not use the bench as a toy, or as a stepping bench.
  - Do not allow two or more persons to sit on the bench.
  - Do not sit on the bench if the bolts holding the bench legs are loose. (If the bolts are loose, immediately re-tighten them using the supplied wrench.)

# Introduction

Thank you, and congratulations on your choice of the Roland Classic Organ C-280. Before using this unit, carefully read the sections entitled: “IMPORTANT SAFETY INSTRUCTIONS” (p. 4), “USING THE UNIT SAFELY” (p. 5), and “IMPORTANT NOTES” (p. 9). These sections provide important information concerning the proper operation of the unit. Additionally, in order to feel assured that you have gained a good grasp of every feature provided by your new unit, Owner’s Manual should be read in its entirety. The manual should be saved and kept on hand as a convenient reference.

## Features of the C-280

---

The C-280 has the following features.

### Classic Design

The C-280’s white/black inverted keyboard and the draw knobs maintain the traditional styling of the positive organ.

### Keyboard with Click

The C-280 keyboard features a “click” feel to provide realistic reproduction of the pipe organ’s tracker action touch, so you can use this feature for surer practice.

### Easy Maintenance

There is no need for maintenance such as adjusting pipes. The C-280 will always sound at its best.

### Accurate and Stable Pitch

Digital technology means that the pitch is always stable. Re-tuning is never necessary, neither after the instrument is transported, nor in response to temperature changes caused by lighting, etc. You can also tune the instrument to Baroque pitch at the touch of a button.

### Historical Temperaments are Supported

In addition to Equal temperament, the C-280 allows you to select Werckmeister, Kirnberger, Vallotti, Meantone, Pythagorean, and Just temperaments at the touch of a button.

### Reproduce the Sound of a Concert Hall

The built-in reverb allows you to reproduce the acoustics of performance spaces ranging from a small room to a large hall, simply by turning a knob. You can enjoy concert hall sound with no additional equipment.

### Volume can be Adjusted as Appropriate for Your Needs

Since the volume can be adjusted freely, you can play at the ideal volume for your ensemble, or for different situations, whether it be the home, chamber concert, or large hall. Headphones can also be used, allowing you to practice at any time of day or night.

### High-Quality Sound

The C-280 employs digitally sampled sources, allowing faithful reproduction of the pipe organ’s reverberation characteristics.

# Contents

<b>USING THE UNIT SAFELY .....</b>	<b>5</b>
<b>Introduction.....</b>	<b>6</b>
Features of the C-280 .....	6
<b>Before You Begin .....</b>	<b>8</b>
Checking the Included Items.....	8
Attaching the Music Stand.....	8
<b>IMPORTANT NOTES.....</b>	<b>9</b>
<b>Front and Bottom Panels.....</b>	<b>10</b>
<b>Preparing to Play .....</b>	<b>12</b>
Connecting the Power Cord .....	12
Turning On the Power.....	12
<b>Basic Operation—Playing.....</b>	<b>13</b>
Adjusting the Volume .....	13
Adjusting the Tonal Character.....	13
Using Headphones.....	13
Creating Organ Tones—Organ Section and Drawknobs .....	14
Creating Organ Tones with the Drawknobs .....	14
Automatically Storing the Drawknob Settings ([Manual] button) .....	16
Storing Organ Tones You Have Created in the Registration Memory ([R1] and [R2] Buttons) .....	16
Calling Up Stored Organ Tones ([R1] and [R2] Buttons) .....	17
Selecting Other Tones—Ensemble Section.....	17
Playing with Layered Organ Section and Ensemble Section Tones .....	18
Cancelling All Selected Tones ([Cancel] Button).....	18
Using Baroque Pitch .....	19
Selecting a Temperament.....	20
Changing the Root Note.....	21
Adding Reverberation (the Reverb Effect).....	22
Tuning.....	22
<b>Listening to the Demo Song.....</b>	<b>23</b>
Demo Song .....	23
<b>Getting the Most out of the C-280 .....</b>	<b>24</b>
Using Damper Pedal/Tone Select Pedal .....	24
Using as a Tone Select Pedal .....	24
Using the Expression Pedal .....	25
Raising/Lowering the Keyboard by an Octave.....	25
Transposing the Keyboard.....	26
<b>Other Functions .....</b>	<b>27</b>
Using a Recording Device or External Amplifier.....	27
Using MIDI.....	27
Making MIDI Connections.....	27
Setting the MIDI Channel.....	28
Local ON/OFF Setting.....	28
<b>Specifications .....</b>	<b>29</b>
Stop List .....	29
Changing the Organ Type.....	29
MIDI Implementation Chart.....	30
Main Specifications .....	31

# Before You Begin

## Checking the Included Items

The Classic Organ C-280 package contains the following items.  
If any items are missing, please contact the dealer where you purchased this unit.

- Owner's manual
- Power cord
- Music stand
- Cover
- Bench

## Attaching the Music Stand

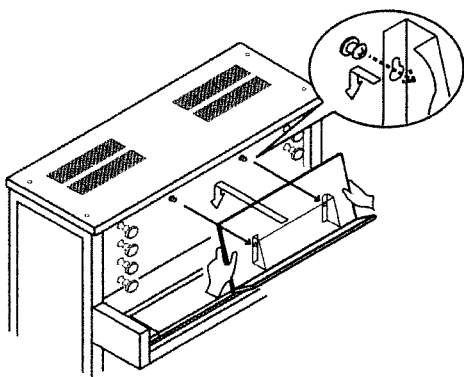

- 1.** Grasping the music stand in both hands, align the fittings on the rear side of the music stand with the pins on the front of the C-280, then snap the stand onto the pins.
- 2.** Gently lower the stand in that position, releasing your hands only after you are sure it is properly supported.

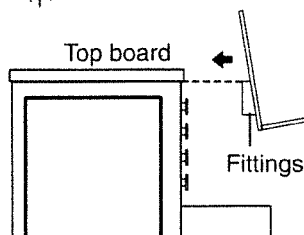

**MEMO**

*To make fitting the pins easier, align the upper ends of the fittings on the rear of the music stand with the top of the C-280.*

**NOTE**

*Do not use excessive force when positioning the music stand. Otherwise, you risk causing accidents and/or damage to the parts.*

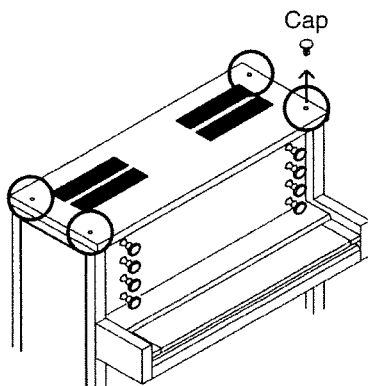

### Notes

Take care not to allow children to swallow the caps attached to the section connecting the C-280 and the pipe system (C-280P; sold separately).



# IMPORTANT NOTES

In addition to the items listed under “IMPORTANT SAFETY INSTRUCTIONS” and “USING THE UNIT SAFELY” on pages 4 and 5, please read and observe the following:

## Power Supply

- Do not use this unit on the same power circuit with any device that will generate line noise (such as an electric motor or variable lighting system).
- Before connecting this unit to other devices, turn off the power to all units. This will help prevent malfunctions and/or damage to speakers or other devices.

## Placement

- This device may interfere with radio and television reception. Do not use this device in the vicinity of such receivers.
- Do not expose the unit to direct sunlight, place it near devices that radiate heat, leave it inside an enclosed vehicle, or otherwise subject it to temperature extremes. Also, do not allow lighting devices that normally are used while their light source is very close to the unit (such as a piano light), or powerful spotlights to shine upon the same area of the unit for extended periods of time. Excessive heat can deform or discolor the unit.
- To avoid possible breakdown, do not use the unit in a wet area, such as an area exposed to rain or other moisture.
- Do not allow rubber, vinyl, or similar materials to remain on the piano for long periods of time. Such objects can discolor or otherwise harmfully affect the finish.
- Do not put anything that contains water (e.g., flower vases) on the piano. Also, avoid the use of insecticides, perfumes, alcohol, nail polish, spray cans, etc., near the unit. Swiftly wipe away any liquid that spills on the unit using a dry, soft cloth.

## Maintenance

- To clean the unit, use a dry, soft cloth; or one that is slightly dampened. Try to wipe the entire surface using an equal amount of strength, moving the cloth along with the grain of the wood. Rubbing too hard in the same area can damage the finish.
- Never use benzine, thinners, alcohol or solvents of any kind, to avoid the possibility of discoloration and/or deformation.

## Additional Precautions

- Use a reasonable amount of care when using the unit’s buttons, sliders, or other controls; and when using its jacks and connectors. Rough handling can lead to malfunctions.
- When connecting / disconnecting all cables, grasp the connector itself—never pull on the cable. This way you will avoid causing shorts, or damage to the cable’s internal elements.
- A small amount of heat will radiate from the unit during normal operation.
- To avoid disturbing your neighbors, try to keep the unit’s volume at reasonable levels. You may prefer to use headphones, so you do not need to be concerned about those around you (especially when it is late at night).
- When you need to transport the unit, package it in the box (including padding) that it came in, if possible. Otherwise, you will need to use equivalent packaging materials.
- Use only the specified expression pedal (EV-5; sold separately). By connecting any other expression pedals, you risk causing malfunction and/or damage to the unit.

# Front and Bottom Panels

## ■ Front Panel

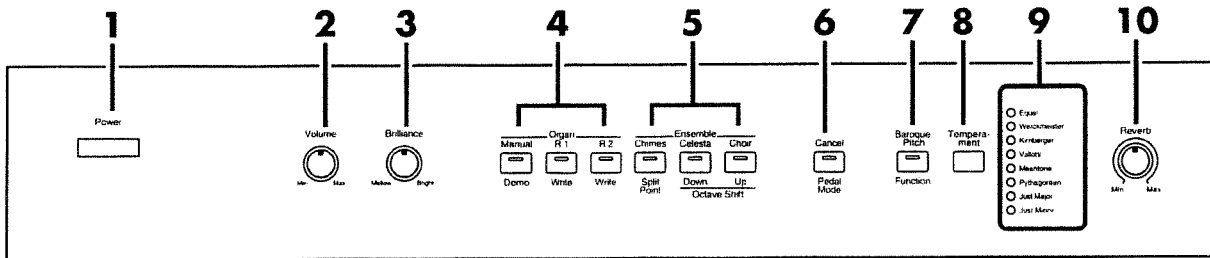

**MEMO**

The terms appearing in orange letters beneath the buttons indicate the names of the functions enabled when the [Function] ([Baroque Pitch]) button is pressed.

### 1. [Power] Switch

Press to switch the power on or off (p. 12).

### 2. [Volume] Knob

Adjusts the overall volume (p. 13).

### 3. [Brilliance] Knob

This adjusts the tonal character (p. 13).

### 4. Organ Section

#### [Manual] Button

This enables selection of the tones using the drawknobs (p. 16).

It also sets the unit so that you can listen to the Demo song (p. 23).

#### [R1] Button

#### [R2] Button

This arrows you to store the drawknob settings. It also is used to call up stored configurations (p. 16).

### 5. Ensemble Section

#### [Chimes] Button

Used to select the sound of Chimes (p. 17).

You can also change the Bass Coupler split point (p. 15).

#### [Celesta] Button

Used to select the sound of Celesta (p. 17).

It also lowers the keyboard's range by one octave (p. 25).

#### [Choir] Button

Used to select the sound of Choir (p. 17).

It also raises the keyboard's range by one octave (p. 25).

### 6. [Cancel] Button

This cancels all tone selections (p. 18).

It also is used to select the damper pedal function (p. 24).

### 7. [Baroque Pitch] Button

Lowers the overall pitch by a semitone (p. 19).

Use as the [Function] button.

### 8. [Temperament] Button

Used to select the temperament (p. 20).

It also sets the tonic for each temperament (p. 21).

### 9. Temperament Indicator

The indicator for the currently selected temperament will light (p. 20).

### 10. [Reverb] Knob

Used to apply reverberation and adjust the amount (p. 22).

## ■ Drawknobs

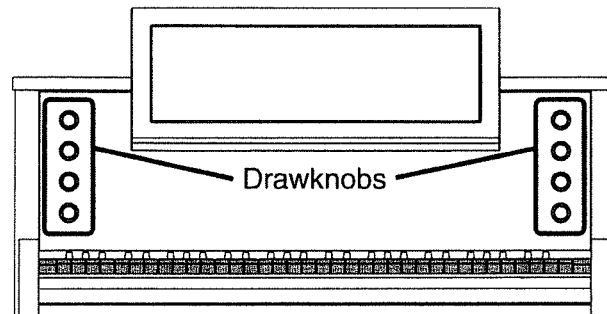

These switch on and off the stops used for the organ tones (p. 14).

## ■ Bottom Panel

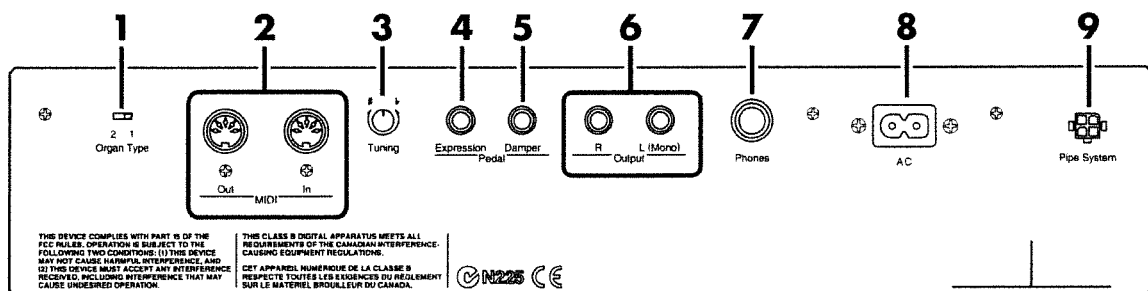

### 1. [Organ Type] Switch

This switches the tone type assigned to the drawknobs (p. 29).

### 2. MIDI Connectors

Connect MIDI cables to these connectors if you wish to exchange MIDI data with external MIDI devices (p. 27).

### 3. [Tuning] Knob

Used to adjust the overall pitch (p. 22).

### 4. Expression Jack

If you connect a separately available pedal to this jack, you will be able to use it as an expression pedal (p. 25).

### 5. Damper Jack

If you connect a separately available pedal to this jack, you will be able to use it as a damper or a tone select pedal (p. 24).

### 6. Output Jacks

Connect cables to these jacks when you wish to play the C-280 through other speakers, or record its sound on a tape recorder (p. 27).

### 7. Phones Jack

A set of headphones can be connected to this jack (p. 13).

### 8. AC Inlet

Connect the supplied power cord to this inlet (p. 12).

### 9. Pipe System Jack

Connect the cable from the pipe system here (C-280P only).

For details, please refer to the leaflet supplied with the pipe system (C-280P; sold separately).

# Preparing to Play

## Connecting the Power Cord

---

### ►Procedure

- 1.** Turn off the [Power] switch located at the left of the panel.
- 2.** Connect the supplied power cord to the AC inlet located on the bottom panel, and then plug the other end into an AC outlet.

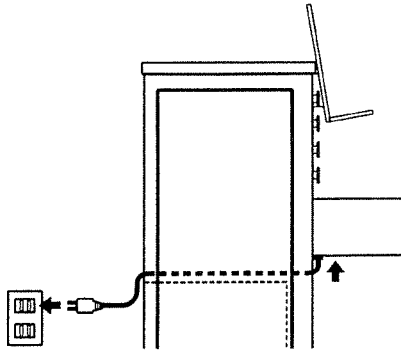

**NOTE** Use only the power cord that was supplied with the C-280.

**NOTE** If you will not be using the C-280 for an extended period, unplug the power cord from the outlet.

## Turning On the Power

---

Be sure to follow the steps below when turning the power on or off. If this is not done in the correct sequence, you risk causing a malfunction, or even blown speakers.

### ►Procedure

- 1.** Rotate the [Volume] knob toward the left to lower the volume.
- 2.** Press the [Power] switch to turn on the power.

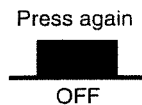
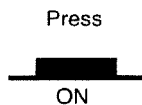

**NOTE**

*This unit is equipped with a protection circuit. A brief interval (a few seconds) after power up is required before the unit will operate normally.*

# Basic Operation—Playing

## Adjusting the Volume

### ►Procedure

Use the [Volume] knob to adjust the volume.

Rotating the knob toward the right will increase the volume, and rotating it toward the left will decrease the volume.

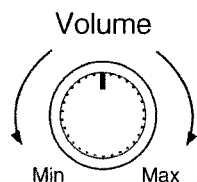

## Adjusting the Tonal Character

### ►Procedure

Use the [Brilliance] knob to adjust the tonal character.

Clockwise rotation adds more brilliance to the tone, while counter clockwise rotation makes it more subdued.

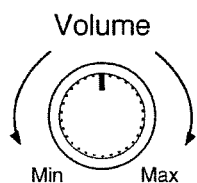

## Using Headphones

The Phones jack is located on the bottom panel of the keyboard. When headphones are connected, no sound will be output from the speakers of the C-280, and only the headphones will be heard. This allows you to play without having to worry about bothering others around you, even at night.

### ►Procedure

Insert the plug of your headphones into the Phones jack.

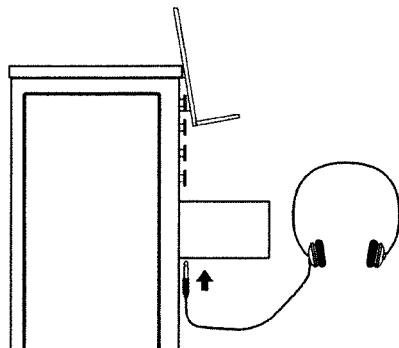

The volume of the headphones can be adjusted with the [Volume] knob.

**NOTE** Accepts connection of Stereo headphones.

**NOTE** Be aware that listening at excessive volume levels or for long periods of time may contribute to hearing loss.

## Creating Organ Tones—Organ Section and Drawknobs

This instrument is equipped with eight stops (drawknobs) for the organ tones, as well as [Manual] button, an [R1] and [R2] button for controlling the stops.

This group of buttons, the [Manual] and [R1]/[R2] buttons, are referred to as the Organ section.

### ■ Creating Organ Tones with the Drawknobs

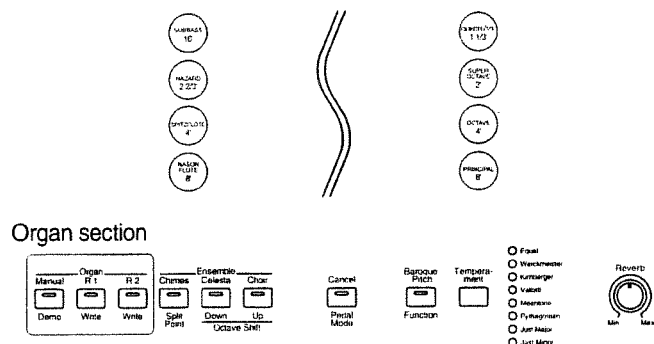

You can operate the drawknobs when any of the Organ section buttons is selected. When the drawknob is pulled out, the light goes on, and the corresponding stop is activated. When the drawknob is pushed back in, the light is extinguished, and the stop is turned off.

Each of these drawknobs can be operated individually, thus allowing you to use them in various combinations to create different tones. A combination of drawknobs used together is called a "Registration."

Stop Name	Description
Principal 8' Octave 4' Super Octave 2'	Foundation stop of principal.
Nason Flute 8' Spitzflöte 4'	Foundation stop of Flute.
Nazard 2 2/3' Quintflöte 1 1/3'	Mutation stop of Flute.
Subbass 16'	Bass Coupler Stop. The name "Bass Coupler" originates from the old Italian term "Basso Continuo" (Thoroughbass). When this stop is activated, this tone is applied only to the lowest note being played on the keyboard. This allows the bass sound to be played even without the pedals, so you can enjoy deep, rich ensemble performances.

**MEMO** C-280 features two types of internal stop sets assigned to the drawknobs. Switch between the two types as befits your liking and use. Please refer to "Stop List" (p. 29).

### Changing the Range Played with the Bass Coupler

Immediately after power to the instrument is turned on, C2–C4 (the two octaves between the lowest-sounding C and Middle C) is specified as the range in which the Bass Coupler sounds. However, this range can be altered.

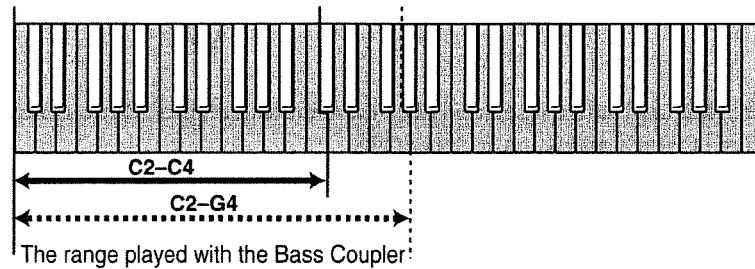

#### ► Procedure

**While holding down the [Function] button, press the [Split Point] button, and while continuing hold down the two buttons, press the highest key, up to which the Bass Coupler will sound.**

Use the C2–G4 notes to select the key.

You can play the Bass Coupler sound within the range between C2 to the specified key.

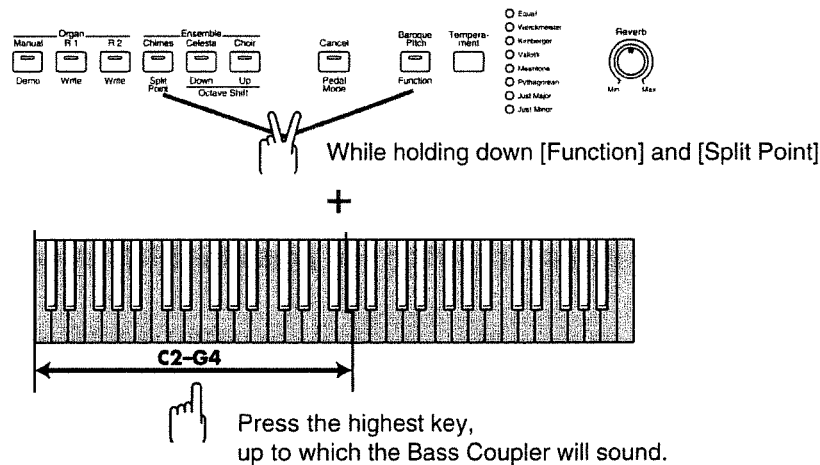

**MEMO** While you specify the range, playing the keyboard will not produce a sound. You can change the range in the intervals of playing on stage.

**MEMO** When the power is turned on, the setting is returned to C2–C4.

## ■ Automatically Storing the Drawknob Settings ([Manual] button)

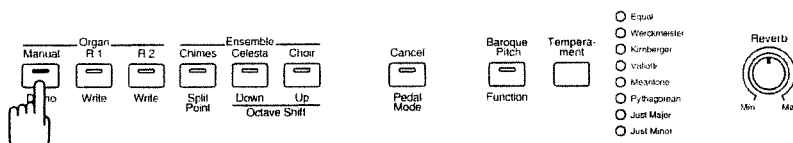

When the [Manual] button is selected (the button indicator lights), it automatically stores the setting of which drawknob is ON or OFF.

After pressing the [R1]/[R2] buttons to call up a Registration, you can still restore the arrangement existing before the Registration was called up by pressing the [Manual] button, and then this can be used as a third Registration.

The drawknob arrangement stored to the [Manual] button remains in effect until the instrument's power is turned off.

**MEMO** All drawknobs are set to OFF when the [Manual] button is selected immediately after the power is turned on.

## ■ Storing Organ Tones You Have Created in the Registration Memory ([R1] and [R2] Buttons)

You can store the current drawknob arrangement (Registration) to the [R1] or [R2] button.

Registrations remain stored at the [R1] or [R2] buttons when the instrument is turned off, allowing you to call up the desired Registration with the press of a button.

### ► Procedure

**Hold down the [Function] button and press the [R1] button or the [R2] button.**

The current drawknob arrangement is stored either to the [R1] or [R2] button.

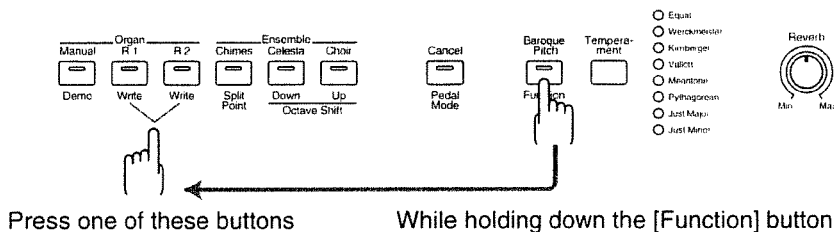

**NOTE** Do not turn the power off before one second has elapsed after pressing one of these buttons. Otherwise, the contents of the Registration maybe changed.



## ■ Calling Up Stored Organ Tones ([R1] and [R2] Buttons)

### ► Procedure

Press the [R1] button or the [R2] button.

When the button is pressed, its indicator lights, and the Registration stored to it is called up.

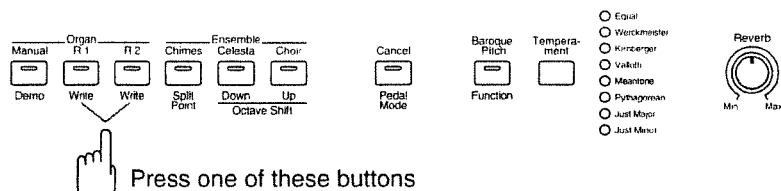

*You can still use the drawknobs when selecting the [R1] or [R2] button.*

*However, once changed, the new arrangement of the drawknob is not stored until the store procedure is carried out.*

#### MEMO

*If the [R1] or [R2] button is pressed again before the changed configuration is stored, the immediately preceding version of the Registration is called up.*

## Selecting Other Tones—Ensemble Section

In addition to the organ tone, this instrument includes three other built-in tones assigned to the three tone buttons below.

These three tone buttons are collectively referred to as the Ensemble section.

### ► Procedure

Press one of the tone buttons in the Ensemble section.

The indicator of the tone button you pressed will light, and that tone will be selected.

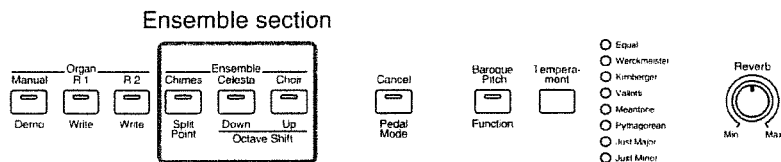

#### MEMO

*You can play the tones for both Organ section and Ensemble section in combination. For details refer to "Playing with Layered Organ Section and Ensemble Section Tones" (p. 18).*

Tone Name	Description
Chimes	The sound of a chime.
Celesta	The sound of a celesta.
Choir	The sound of a choir.

## Playing with Layered Organ Section and Ensemble Section Tones

You can select one tone each from the Organ and Ensemble sections, and then perform with the two tones layered.

Example: Using Celesta for the [Manual] button tone, Chimes for the [R2] button tone

### ► Procedure

**While holding down one of the Organ section buttons, press the button in the Ensemble section for the tone you want to layer.**

The indicators of both buttons will light, and you will be able to play both sounds simultaneously.

It is not possible to layer sounds within the same section (Celesta and Choir, for example).

Example : To add Celesta to the [Manual] button tone

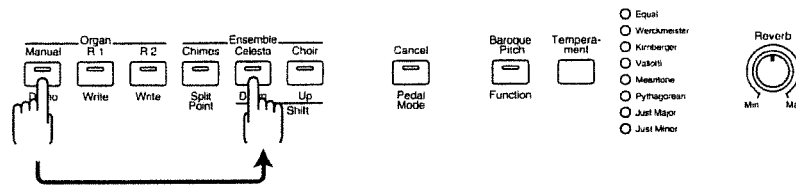

While holding down the [Manual] button, press the [Celesta] button.

## Cancelling All Selected Tones ([Cancel] Button)

You can cancel all tone selections with one button.

### ► Procedure

**Press the [Cancel] button.**

All tone selections, including those made with the drawknobs, are cancelled, restoring the arrangement selected with the [Manual] button.

This is the same status existing when the power is turned on.

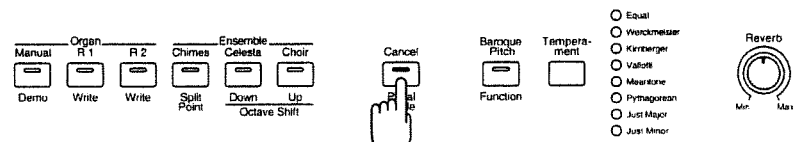

**MEMO** Registrations stored to the [R1] and [R2] buttons are not deleted.

## Using Baroque Pitch

The standard pitch can be changed from A=440 Hz (when the [Tuning] knob is in the center position) to the A=415 Hz pitch that is often used as Baroque pitch.

### ► Procedure

**Press the [Baroque Pitch] button.**

The button indicator will light, and the overall pitch will drop by a semitone (100 cents).

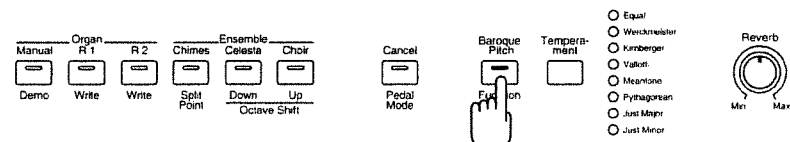

To return to the A=440Hz pitch, press the same button once again.

#### MEMO

*If you wish to use other pitches, refer to "Tuning" (p. 22) or "Transposing the Keyboard" (p. 26).*

## Selecting a Temperament

The C-280 allows you to change the temperament simply by pressing a button.

### ► Procedure

**Repeatedly press the [Temperament] button until the indicator for the desired temperament lights.**

Hold down the [Temperament] button, and the indicators for the various temperaments you can select from will successively go into the blinking state. When the indicator for the temperament you want is blinking, release your finger from the button. That temperament will then be placed in effect.

After advancing to Just Minor, you will return again to Equal.

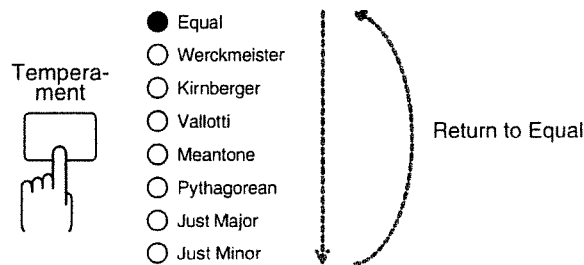

**MEMO** When you turn on the power, Equal is selected.

You can select one of the following eight temperaments.

Temperament	Description
<b>Equal</b>	Here, notes in all scales are spaced uniformly; this is the most widely used temperament.
<b>Werckmeister</b>	This is Werckmeister temperament, type 1-3. This temperament offers greater freedom of modulation than does the Meantone, so it is popular for chordal compositions with key signatures having few accidentals, or for melodic playing in compositions featuring many accidentals.
<b>Kirnberger</b>	This is Kirnberger temperament, type 3. While providing freedom of modulation, the clear difference between the Werckmeister temperament's pure thirds and those which are not pure brings out the differences in resonance from the adjustments. In particular, the sensation of tension is strongest in the third between A $\flat$ and C.
<b>Vallotti (Young)</b>	This tuning eliminates the dissonant (wolf) interval of the Pythagorean scale, and uses something approaching a pure third only for this interval. Of all the temperaments here, this is closest to the Equal temperament in being without idiosyncrasies. The Young temperament is obtained by changing the tonic to G. As the temperament of this instrument centers on A, be sure to retune when playing together with another instrument. Vallotti is suitable for keys with flats in the key signature, such as the key of F major or B flat major, and Young is suitable for key signatures with sharps, such as D major or E major.
<b>Meantone</b>	This is Aaron's meantone temperament. This temperament is composed differently, with the pure fifth compromised to permit modulation that is impossible in Just tunings. The dissonant fifth between G $\sharp$ and E $\flat$ when C is the tonic is preserved, making it possible to modulate up to three sharps and two flats in Major keys, and up to two flats in minor keys.
<b>Pythagorean</b>	While melodic lines played in this temperament, consisting of pure fourths and fifths, resonate beautifully, the overt acoustic discrepancy of the thirds makes it unsuitable for harmonic playing. Furthermore, the dissonant (wolf) fifth is preserved (between G $\sharp$ and E $\flat$ when C is the tonic), thus disallowing modulation. On the other hand, in chordal applications, shifting the tonic six semitones (for example, performing in C Major when the Tonic is G $\flat$ ) and using a wolf interval between the root and the third allows you to achieve something very close to a Just temperament.

Temperament	Description
Just Major	This is a temperament in which the primary triads are created with a pure third and fifth. While this temperament provides beautiful chords with no acoustic discrepancy, the considerable irregularity of intervals in the scale makes it unsuitable for melodic playing. This acoustic discrepancy is especially pronounced between D and A, and between A $\flat$ and C, so no modulation is possible.
Just Minor	As in Just Major, intervals in the primary triads are preserved as pure. The dissonance of the interval between C and A $\flat$ in Major mode is improved, allowing the primary triads to be played in minor mode. The tonic is set to C when the power is turned on, making such chords in C minor pure.

### Notes on the Use of Classical Temperaments

Using the temperament whose characteristics are best suited for the type of music being played allows one to draw even more of the beauty and tension contained in a piece. In particular, employing temperaments that can be transposed in pieces featuring modulation results in subtle changes in chords' resonance, permitting alterations in the work's subtle coloration.

Werckmeister combined with Meantone and Pythagorean scales is one temperament that allows a high degree of freedom in modulation, and it has been used in pieces from Bach's day on into modern times. The Kirnberger temperament was also devised with a similar technique, with its use centering on Bach's organ works.

The Meantone temperament, popular throughout Europe during the Baroque period, was commonly used in the works of Handel and other Baroque composers, as well as composers of the Renaissance.

In the Middle Ages, Gregorian chants were sung in churches, so the Pythagorean temperament was used due to the lengthy reverberation times.

The Vallotti is the most recent of these temperaments. While close to the Equal temperament, it is to a degree Just, so it is adaptable to pitches from other instruments, and is often used in today's ensembles.

Originating in ancient Greece, the Just temperaments, while not well suited for solo passages, can be used effectively in cases such as in choral practices for which Just chords are required. In recent years, they have come to be used in types of music in which the beauty of such chords is thought to be useful in promoting healing.

## Changing the Root Note

You must specify the root note to match the key in which you wish to play.

### ► Procedure

**Hold down the [Temperament] button, and play the key for the desired root note.**

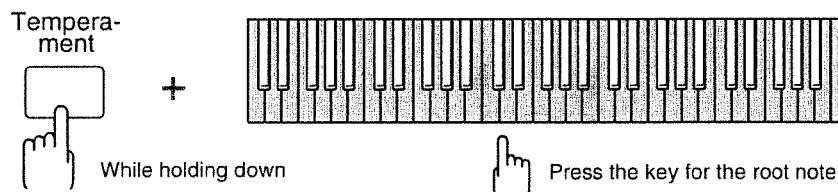

**MEMO** When the power is turned on, the key of C will be selected for the root note.

**MEMO** It is possible to change the root note even when the temperament except for Equal temperament is selected. However, for temperaments that allow modulation (Werckmeister, Kirnberger, Vallotti, etc.), you will normally use the default setting of C.

**MEMO** The root note that is specified by this operation will not change even if you change the temperament. When performing in an ensemble, discrepancies in pitch may result when you switch the temperament or the root note. On the C-280, the pitch of other notes is always adjusted relative to the pitch of the A note.

---

## Adding Reverberation (the Reverb Effect)

---

Reverb is an effect which simulates the reverberation that is heard as a result of sound reaching the ear after reflecting off the walls or other surfaces of the room or hall (in addition to the sound that reaches the ear directly from the instrument).

The C-280 allows you to produce a range of reverberation from that of small rooms to large halls, simply by turning a single knob.

► **Procedure**

**Use the [Reverb] knob to adjust the amount of the reverb effect.**

Rotating the knob toward the right will simulate the reverberation of a larger hall, and rotating it toward the left will simulate the reverberation of a smaller chamber. When the knob is rotated all the way toward the left, there will be no reverb effect.

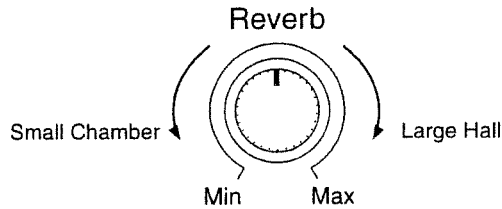

---

## Tuning

---

The C-280 can be tuned to the pitch of other instruments.

► **Procedure**

**Use the [Tuning] knob located on the bottom panel to adjust the pitch.**

When the knob is in the center position, the pitch will be A=440 Hz. Rotating the knob toward the # mark will raise the pitch, and rotating it toward the b mark will lower the pitch.

The range of adjustment is  $\pm 1/2$  semitone (50 cents).

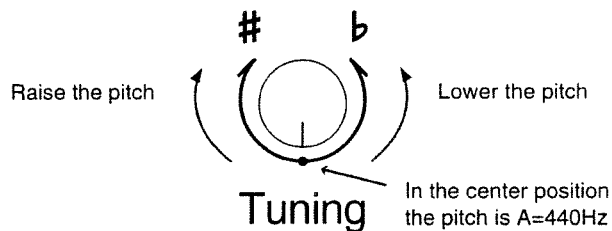

**MEMO** When Baroque pitch is ON, the range of adjustment will be  $\pm 1/2$  semitone relative to A=415 Hz. Refer to "Using Baroque Pitch" (p. 19).

# Listening to the Demo Song

The C-280 contains demo song. The demo song can be used for sound checks in a concert hall, or when you wish to listen to the C-280 for background music.

## ► Procedure

### 1. Hold down the [Function] button, and press the [Demo] button.

The [Demo] button indicator and the [Function] button indicator will blink, and demo playback will begin.

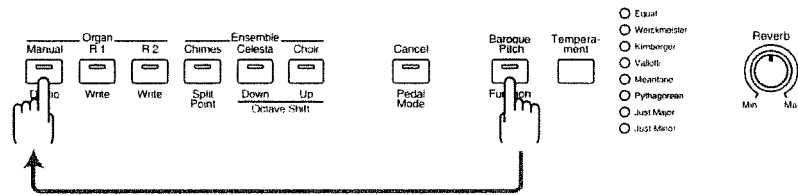

Press the [Demo] button

While holding down the [Function] button

### 2. During playback, you can go to the next variation of the song by pressing the [Demo] button.

### 3. To stop playback, press the [Function] button.

The song will continue playing in succession until you stop the playback.

#### NOTE

*It is not possible to change the drawknob and tone buttons and play the keyboard while the demo song is playing.*

## Demo Song

<b>Song Title</b>	Aria Sebalдина
<b>Composer</b>	J. Pachelbel
<b>Temperament</b>	Meantone A $\flat$

© 1999 Roland Corporation

#### NOTE

*All rights reserved. Unauthorized use of this material for purposes other than private, personal enjoyment is a violation of applicable laws.*

#### NOTE

*No data for the music that is played will be output from MIDI Out.*

# Getting the Most out of the C-280

## Using Damper Pedal/Tone Select Pedal

If you connect a separately available pedal switch (such as the DP-6 or DP-2) to the Pedal jack located on the bottom panel, you will be able to use pedal functions.

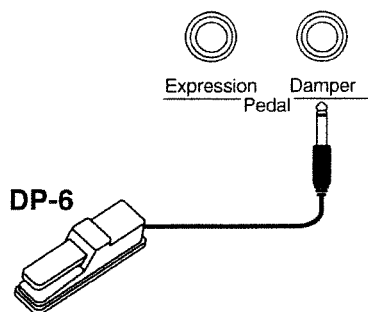

The pedal can perform the following two functions

### Damper Pedal

In the same way as the damper pedal of a piano, pressing the pedal will allow notes to be sustained even after you release your finger from the key.

**MEMO** The damper pedal works only with attenuated Celesta tones.

### Tone select pedal

By depressing this pedal, you can select two tones from the tone buttons in the Organ ([Manual]/[R1]/[R2]) and Ensemble sections.

**NOTE** When the power is turned on, the pedal will function as a damper pedal.

## ■ Using as a Tone Select Pedal

### ► Procedure

1. Hold down the [Function] button, and press the [Pedal Mode] button.

The [Pedal Mode] button indicator will light.

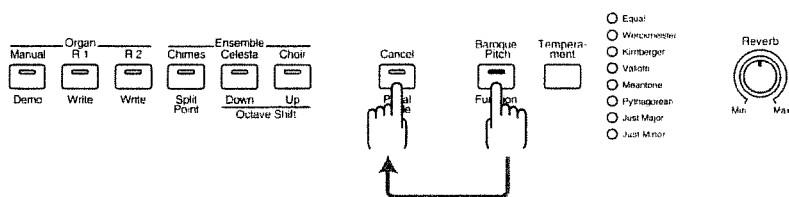

Press the [Pedal Mode] button While holding down the [Function] button

2. Press the two desired tone buttons in sequence.

This will specify the tones that will be selected.

Each time you press the pedal, you will alternate between these two sounds.

If you press only one button, you will alternate between that tone and the previously selected tone.

Once again press the [Function] button and the [Pedal Mode] button. The [Pedal Mode] button indicator will go dark, and you will return to the damper pedal function.

**NOTE** If you perform this procedure, the pedal switch cannot be used as a damper pedal.



## Using the Expression Pedal

If you connect a separately available expression pedal (such as the EV-5) to the Expression jack located on the bottom panel, you will be able to control the volume with the expression pedal.

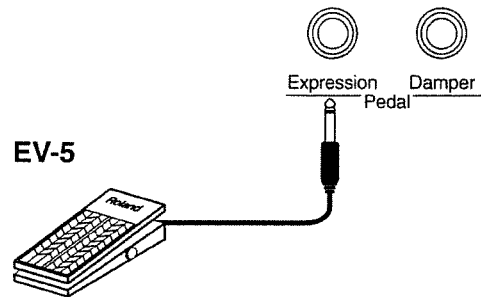

**NOTE** Use only the specified expression pedal (EV-5; sold separately). By connecting any other expression pedals, you risk causing malfunction and/or damage to the unit.

## Raising/Lowering the Keyboard by an Octave

If the compass of the keyboard is insufficient, you can raise or lower the entire keyboard by one octave to access the desired range of pitches.

### ► Procedure

**Hold down the [Function] button, and press either the [Up] button or the [Down] button.**

The indicator of the button you pressed will light, and the pitch of the keyboard will change.

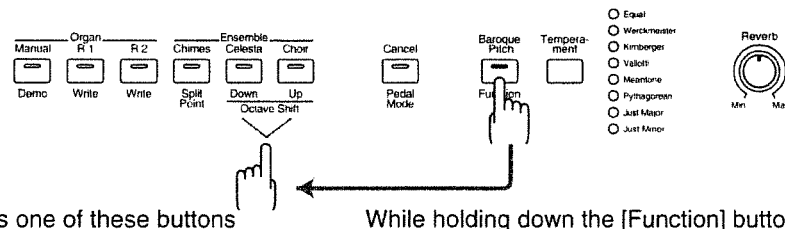

Press one of these buttons While holding down the [Function] button

### [Up] button

The keyboard will be pitched one octave higher.

To return to the normal pitch, hold down the [Function] button and press the [Down] button.

The [Up] button indicator will go dark, and the pitch will return to normal.

### [Down] button

The keyboard will be pitched one octave lower.

To return to the normal pitch, hold down the [Function] button and press the [Up] button.

The [Down] button indicator will go dark, and the pitch will return to normal.

**MEMO** Even if you select a different sound, the raised or lowered octave status will not change.

**MEMO** When the power is turned on, the keyboard will be pitched normally.

---

## Transposing the Keyboard

---

You can transpose your performance without changing the keys that you play.  
This feature is called "Key Transpose."

► **Procedure**

**Hold down the [Function] button, and press the note that corresponds to the desired key.**

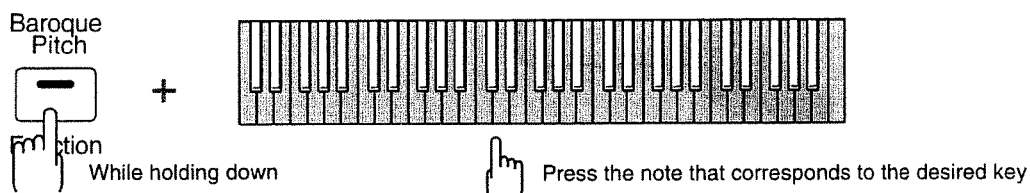

For example if you want the  $E\flat$  pitch to sound when you play the C key, you would hold down the [Function] button and press the  $E\flat$  key.

To return to the normal pitch, use the same procedure, but push the C key.

*The range available for transposition is from -6 semitones ( $F\sharp$ ) to +5 semitones (F), when C note in the key of C major is the basic note.*

**MEMO**

*Although you can obtain a transposition by pressing any key, the pitch will be adjusted so it fits the acceptable range.*

**MEMO**

*When the power is turned on, the keyboard will be pitched normally.*

**MEMO**

*If you wish to use  $A=392$  Hz as Baroque Pitch, use this function to specify a transposition of  $B\flat$ . In this case, leave the Baroque pitch (p. 19) is OFF.*

# Other Functions

## Using a Recording Device or External Amplifier

The sound of the C-280 can be recorded directly to a tape recorder or other recording device without using a microphone. You can also use an external amplifier to listen to the C-280 through other speakers.

**NOTE** To prevent malfunction and/or damage to speakers or other devices, always turn down the volume, and turn off the power on all devices before making any connections.

### >Procedure

1. Turn off the power on the C-280 and on the recording device that you intend to connect.
2. Connect the Output jacks (located on the bottom panel of the C-280) to the input jacks of the recording (or other) device.

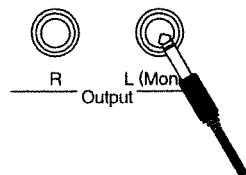

3. Turn on the power of the C-280.
4. Turn on the power of the connected device.

**NOTE** If the input of the connected device is monaural, you must use the Output L (Mono) jack.

**MEMO** If you do not want sound to be output from the speakers of the C-280, plug a set of headphones into the Phones jack.

## Using MIDI

The MIDI connectors of the C-280 allow it to exchange music data with other MIDI devices. MIDI lets you do a variety of things, such as recording your own performance and playing it back at a different tempo without changing the pitch, and allows you to edit your performance in a variety of ways.

### ■ Making MIDI Connections

- **MIDI Out connector**  
If you wish to transmit music data from the C-280 to an external MIDI device, connect this connector to the MIDI In connector of the other device.
- **MIDI In connector**  
If you want the C-280 to receive music data from an external MIDI device, connect the MIDI Out connector of the other device and this connector.

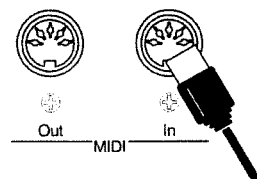

**MEMO** Use a separately available MIDI cable to make the connections.

## ■ Setting the MIDI Channel

In order to exchange (transmit or receive) MIDI messages with another MIDI device, the transmitting device and receiving device must be set to the same MIDI channel.

### ► Procedure

**While holding down the [Function] button, press the [Temperament] button, and while continuing to hold down the two buttons, press the key (C2 – D#3) that corresponds to the desired MIDI channel.**

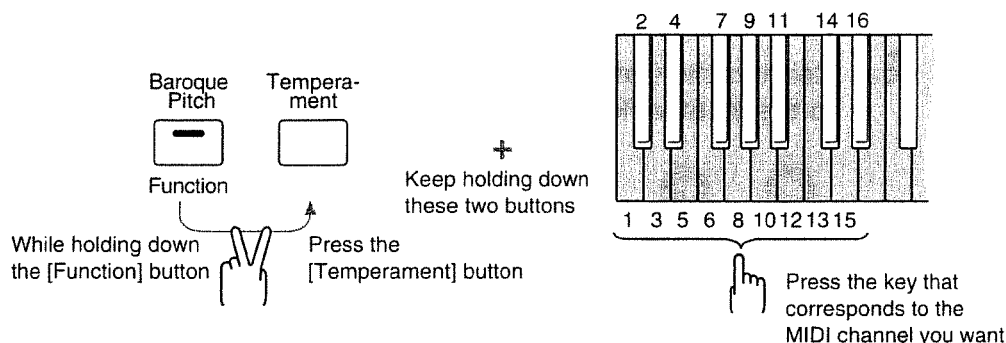

**MEMO** When the power is turned on, the MIDI channel setting is at "1."

## ■ Local ON/OFF Setting

Normally, MIDI data will be sent from the keyboard to the internal sound generator (Local ON). However if you want the data from the keyboard to be sent via MIDI Out to an external device, and then re-transmitted from that external device back to the MIDI In of the C-280 to produce sound, you can break the internal connection between the C-280's keyboard and sound generator (Local OFF). This will avoid the duplication of data that would otherwise result.

### ► Procedure

**While holding down the [Function] button, press the [Temperament] button, and while continuing to hold down the two buttons, press the right-most key (C7) to turn Local ON or press the key beside it (B6) to turn Local OFF.**

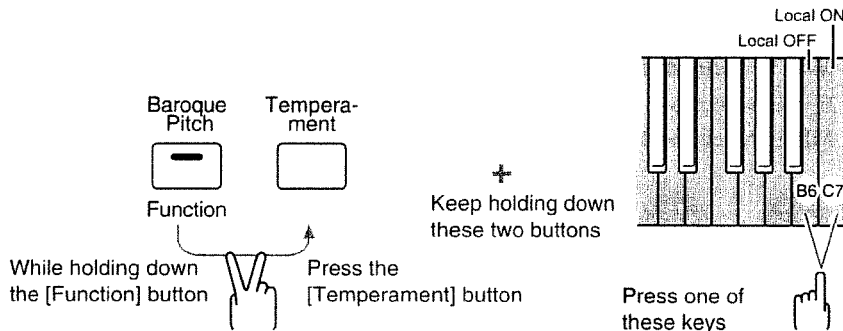

When this is turned Local OFF, playing the keyboard of the C-280 will not produce sound.

**MEMO** When the power is turned on, this setting will be Local ON.

# Specifications

## Stop List

Type 1	Type 2
Principal 8'	Diapason 8'
Nason Flute 8'	Gedackt 8'
Octave 4'	Principal 4'
Spitzflöte 4'	Rohrflöte 4'
Super Octave 2'	Fifteenth 2'
Nazard 2 2/3'	Tierce 1 3/5'
Quintflöte 1 1/3'	Mixture IV
Subbass 16' (Bass Coupler)	Principal 16' (Bass Coupler)

### ■ Changing the Organ Type

This instrument features two types of internal stop sets assigned to the drawknobs. Type 1 contains the Baroque stops used classical music, and Type 2 includes more contemporary Romantic-style sounds. Switch between the two types as befits your liking and use.

#### ► Procedure

Move the [Organ Type] switch on the bottom panel to either Type 1 or Type 2.

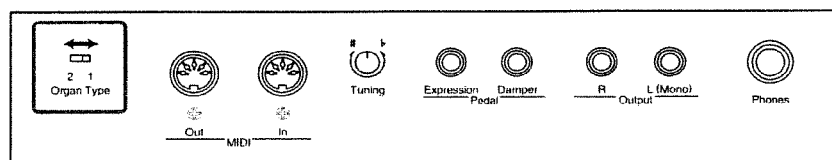

**MEMO** This factory default setting is Type 1.

**MEMO** The tone appearing on the drawknobs refers to tones in Type 1; when switching to Type 2, please refer to the chart above for the switched tones.

Classic Organ  
Model C-280

### MIDI Implementation Chart

Date : Oct. 1, 1999  
Version : 1.00

Function...	Transmitted	Recognized	Remarks
Basic Channel : Default Changed	1 1-16	1 1-16	
Mode : Default Messages Altered	Mode 3 x .....	Mode 3 x	
Note Number : True Voice	18-113 .....	0-127 18-113	
Velocity : Note ON / Note OFF	O O	O O	
After Touch : Key's / Ch's	x x	x x	
Pitch Bend	x	x	
Control Change : 6, 38 / 7 / 11 / 64 / 100, 101	O x O O O	O O O O O	Data entry Volume Expression Hold 1 RPN LSB, MSB
Prog Change : True #	O (0 ... 48) .....	O (0-127) 0 ... 48	
System Exclusive	O	O	
System Common : Song Pos / Song Sel / Tune	x x x	x x x	
System Real Time : Clock / Commands	x x	x x	
Aux Message : All sound off / Reset all controllers / Local ON / OFF / All Notes OFF / Active Sense / System Reset	x x x x O x	x O O O (123-127) O O x	
Notes			

Mode 1 : OMNI ON, POLY    Mode 2 : OMNI ON, MONO    O : Yes  
Mode 3 : OMNI OFF, POLY    Mode 4 : OMNI OFF, MONO    X : No

\* A separate publication titled "MIDI Implementation" is also available. It provides complete details concerning the way MIDI has been implemented on this unit. If you should require this publication (such as when you intend to carry out byte-level programming), please contact the nearest Roland Service Center or authorized Roland distributor.

---

## Main Specifications

---

- **Keyboard**  
C scale 61 keys with Click
- **Maximum Polyphony**  
64 voices
- **Tones**  
Organ (8 stops x 2 types)  
Chimes  
Celesta  
Choir (2 tones)
- **Effects**  
Reverb with Stereo Presence
- **Key Transpose**  
-6—+5 Half-steps
- **Temperament**  
8 types, selectable tonic
- **Tuning**  
A=440 Hz  $\pm$ 1/2 semi-tones (50 cents),  
Baroque Pitch (A=415 Hz)
- **Connectors**  
Headphones Jack (stereo)  
Damper Pedal Jack (Hold or Tone Select)  
Expression Pedal Jack  
AC Inlet  
MIDI Connectors (In, Out)  
Output Jacks (L (Mono), R)  
Pipe System Connector
- **Speakers**  
<C-280>  
20 cm x 2  
<Pipe System (C-280P; sold separately)>  
5 cm x 2
- **Rated Power Output**  
25 W x 2
- **Power Supply**  
AC 117 V, AC 230 V, AC 240 V
- **Power Consumption**  
125 W (AC 117 V),  
125 W (AC 230 V),  
130 W (AC 240 V)
- **Cabinet Finish**  
Traditional Walnut
- **Dimensions**  
<C-280>  
985 (W) x 634 (D) x 1130 (H) mm  
38-13/16 (W) x 25 (D) x 44-1/2 (H)\* inches  
\*Including the Pipe System:  
1,900 (H) mm (74-13/16 (H) inches)  
  
<Pipe System (C-280P; sold separately)>  
985 (W) x 367 (D) x 883 (H) mm  
38-13/16 (W) x 14-1/2 (D) x 34-13/16 (H) inches
- **Weight**  
<C-280>  
59.3 kg  
131 lbs 3 oz  
<Pipe System (C-280P; sold separately)>  
33.5 kg  
73 lbs 14 oz
- **Accessories**  
Owner's Manual  
Power Cord  
Music Stand  
Bench  
Cover

\* In the interest of product improvement, the specifications and/or appearance of this unit are subject to change without prior notice.

---

# MEMO

---



# Before You Begin

## ■ Attaching the Music Stand

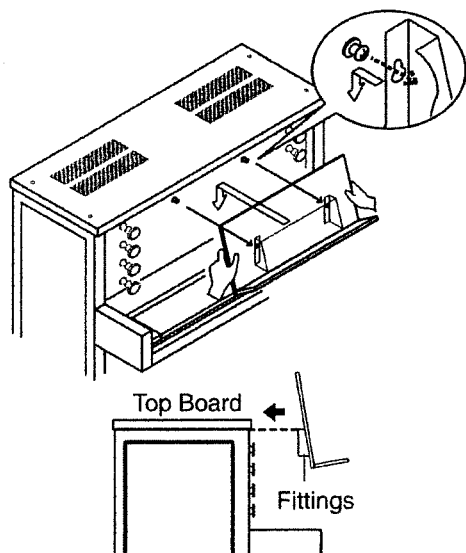

1. Grasping the music stand in both hands, align the fittings on the rear side of the music stand with the pins on the front of the C-280, then snap the stand onto the pins.
2. Gently lower the stand in that position, releasing your hands only after you are sure it is properly supported.

To make fitting the pins easier, align the upper ends of the fittings on the rear of the music stand with the top of the C-280.



### Note

Do not use excessive force when positioning the music stand. Otherwise, you risk causing accidents and/or damage to the parts.



### Note

Take care not to allow children to swallow the caps attached to the section connecting the C-280 and the pipe system (C-280P; sold separately).

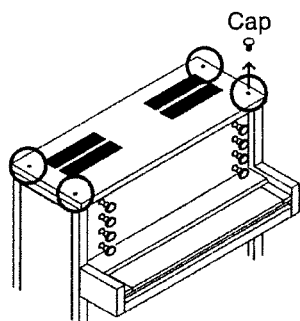

## ■ Handling the Special C-280 Cover

This special cover can be used either for the C-280 organ alone, or for the organ with the C-280P pipe system attached.

The cover has been pre-folded to conform to the shape of the C-280 organ with the C-280P pipe system attached (Fig. 2). If using the cover for the C-280 organ alone, open the cover as shown in the Fig. 1. Whichever configuration is used, make sure that the cover itself goes over the top of the music stand.

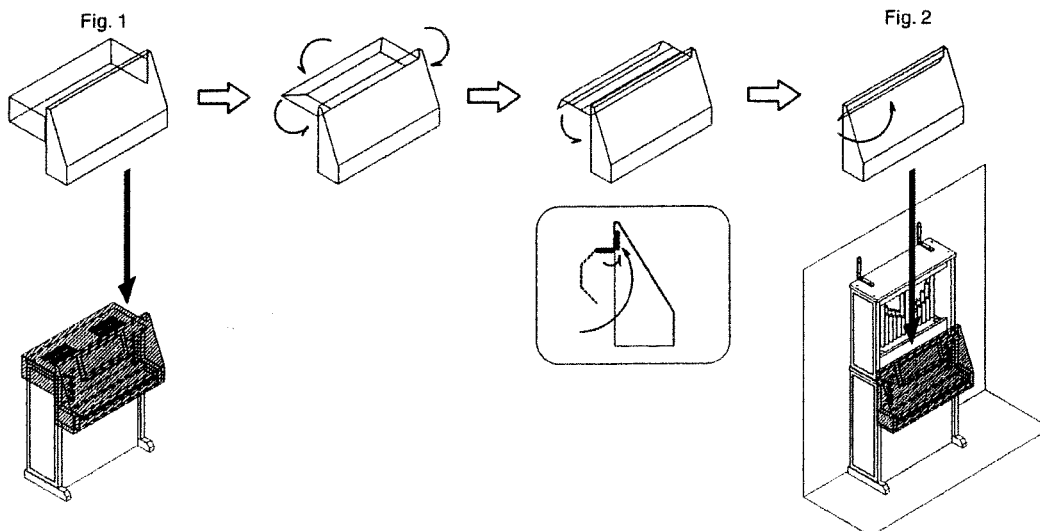





# Installing the Pipe System C-280P



- Make sure that another person is on hand to help with the assembly and setup.
- Be very careful when lifting and moving the organ, since it is quite heavy.
- Be very careful, when you assemble and move the organ, to make sure that you do not drop it on your hands or feet.
- To move the organ, lift it carefully—all the while keeping it level.
- When assembling the organ and the pipe system, do not apply excessive pressure on any part. To do so can cause metal parts to get bent out of shape, and may damage wooden parts.
- To prevent the pipe system from falling over, use the anti-earthquake cabinet holders to secure the unit to a wall surface.

## ● Before Installing This Unit

Before you begin, check that all the parts were supplied.

- |   |                                      |
|---|--------------------------------------|
| ①  | ① Dowel x 4                          |
| ②  | ② Metal Plate x 2                    |
| ③  | ③ Screw a x 4                        |
| ④  | ④ Anti-earthquake cabinet holder x 2 |
| ⑤  | ⑤ Screw b x 8                        |

## ● Setup

- Fasten each screw tightly.
  - This unit must be carefully placed so it is level and sure to remain stable.
  - Do not allow the speaker cord, power cord or connection cord to get twisted or pinched while assembling the C-280P.
  - Connect the C-280P only after confirming that the organ is set up on flooring that is both stable and level.
  - Remove the music stand before setting up the pipe system (for instructions on removing the music stand, refer to the C-280 Organ Owner's Manual).
  - To prevent accidental falls and injury, refrain from stepping on, or hanging from the organ brackets during or after installation of the pipe system.
1. Remove the four caps found at the positions indicated in the figure of the organ's top panel.
  2. Insert the four dowels in the holes revealed when the caps are removed, and screw down the dowels securely, so that they do not shake or rattle within the holes.
  3. Align the four holes on the bottom surface of the pipe system with the four dowels protruding from the organ's upper panel, then affix the pipe system, making sure all dowels are fully inserted in the holes.
- When setting up the pipe system, grip the handle on the rear and the front of the side panel, taking care not to allow your hand to become caught between the organ and the pipes.
  - Also make sure that the connection cord is not pinched between the organ and the pipes.

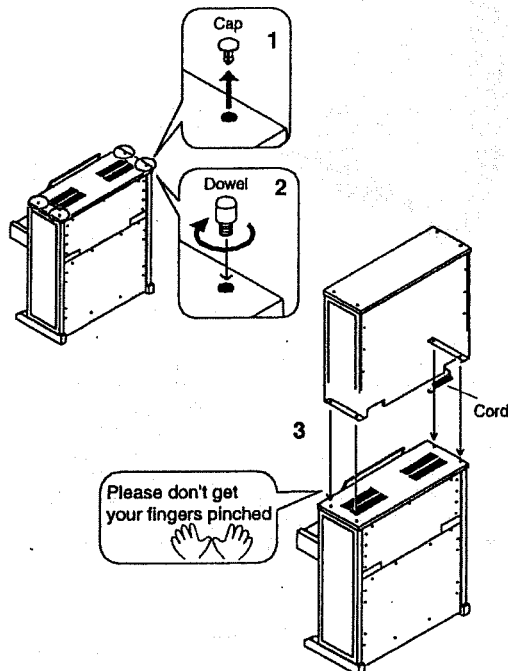

4. Run the connection cord extending from the handle on the rear panel of the pipe system past the handle on the organ's rear panel, then plug the cord into the pipe system connector at the bottom of the organ.

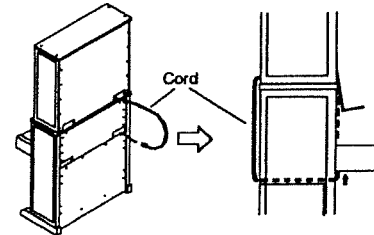

5. Position the metal plate vertically across the rear panels of the organ and pipe system, then fasten the plate with screws "a."

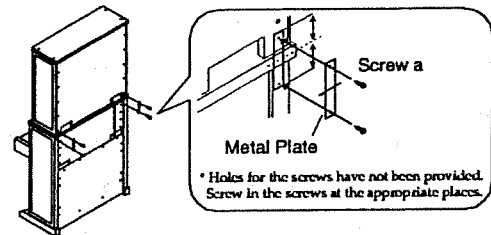

6. Move the entire assembly to the wall. Then, to prevent the system from falling over, fasten the anti-earthquake cabinet holders in the two positions indicated in the figure with screws "b."

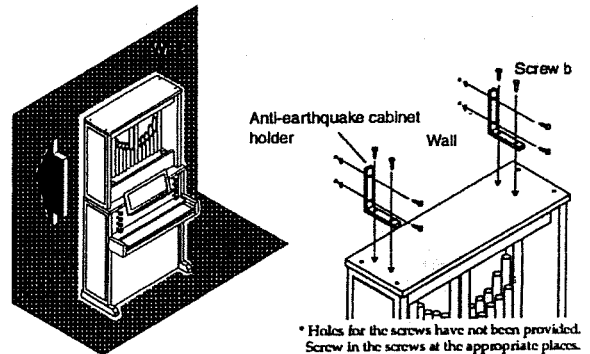

## ● Precautions When Using the Safety Hardware

- Fasten the hardware to a wall with a thickness of at least 17 mm. Make sure the core material of the wall is strong enough to withstand the weight. If not, the brackets should be fastened to crosspieces (or other beams running through the wall) instead.
- The screws included with the hardware are meant to be screwed into hard wood, wall core, or similar material. Attaching the hardware to lumber butt ends, concrete walls, gypsum board, or other such surfaces requires the use of special hardware and screws; consult your contractor or carpenter.
- When properly installed, this hardware is extremely effective in preventing the organ and pipes from falling over. However, in addition to incorrect installation, certain factors, including weakening of walls due to unexpectedly strong earthquakes, or deterioration of the lumber used may prevent realization of such effectiveness. In the event of an earthquake, immediately move away from the organ.

## ● When Moving the Organ

- Be sure to first disconnect the connection cord and remove the metal plate and the anti-earthquake cabinet holder, then carry the C-280P and the organ separately.

 Roland®

---

**40344201**

UPC 40344201



10991

**Roland**

## Information

When you need repair service, call your nearest Roland Service Center or authorized Roland distributor in your country as shown below.

### AFRICA

#### EGYPT

**Al Fanny Trading Office**  
P.O. Box 2904,  
El Horrieh Heliopolis, Cairo,  
EGYPT  
TEL: (02) 4185531

#### REUNION

**Maison FO - YAM Marcel**  
25 Rue Jules MermanZi,  
Chaudron - BI79 97491  
Sie Clotilde REUNION  
TEL: 28 29 16

#### SOUTH AFRICA

**That Other Music Shop  
(PTY) Ltd.**  
11 Melle Street (Cnr Melle and  
Juta Street)  
Braamfontein 2001  
Republic of SOUTH AFRICA  
TEL: (011) 403 4105

**Paul Bothner (PTY) Ltd.**  
17 Werdmuller Centre Claremont  
7700  
Republic of SOUTH AFRICA

P.O. Box 23032  
Claremont, Cape Town  
SOUTH AFRICA, 7735  
TEL: (021) 64 4030

### ASIA

#### CHINA

**Beijing Xinghai Musical  
Instruments Co., Ltd.**  
6 Huangmunchang Chao Yang  
District, Beijing, CHINA  
TEL: (010) 6774 7491

#### HONG KONG

**Tom Lee Music Co., Ltd.  
Service Division**  
22-32 Pun Shan Street, Tsuen  
Wan, New Territories,  
HONG KONG  
TEL: 2415 0911

#### INDIA

**Rivera Digitec (India) Pvt. Ltd.**  
409, Nirman Kendra Mahalaxmi  
Flats Compound Off. Dr. Edwin  
Moses Road, Mumbai-400011,  
INDIA  
TEL: (022) 498 3079

#### INDONESIA

**PT Citra Inti Rama**  
Jl. Cideng Timur No. 151-150  
Jakarta Pusat  
INDONESIA  
TEL: (021) 6324170

#### KOREA

**Cosmos Corporation  
Service Station**  
261 2nd Floor Nak-Won Arcade  
Jong-Ro ku, Seoul, KOREA  
TEL: (02) 742 8844

#### MALAYSIA

**Bentley Music SDN BHD**  
140 & 142, Jalan Bukit Bintang  
55100 Kuala Lumpur, MALAYSIA  
TEL: (03) 2443333

#### PHILIPPINES

**G.A. Yupangco & Co. Inc.**  
339 Gil J. Puyat Avenue  
Makati, Metro Manila 1200,  
PHILIPPINES  
TEL: (02) 899 9801

#### SINGAPORE

**Swee Lee Company**  
130 Sims Drive,  
SINGAPORE 387381  
TEL: 748-1669

#### CRISTOFORI MUSIC PTE LTD

BK 3014, Bedok Industrial Park E,  
#02-2148, SINGAPORE 489980  
TEL: 243 9555

#### TAIWAN

**ROLAND TAIWAN  
ENTERPRISE CO., LTD.**  
Room 5, 9th. No. 112 Chung Shan  
N.Road Sec.2, Taipei, TAIWAN,  
R.O.C.  
TEL: (02) 2561 3339

#### THAILAND

**Theera Music Co., Ltd.**  
330 Verng NakornKasem, Soi 2,  
Bangkok 10100, THAILAND  
TEL: (02) 2248821

#### VIETNAM

**Saigon Music**  
138 Tran Quang Khai St.,  
District 1  
Ho Chi Minh City  
VIETNAM  
TEL: (08) 844-4068

### AUSTRALIA/ NEW ZEALAND

#### AUSTRALIA

**Roland Corporation  
Australia Pty., Ltd.**  
38 Campbell Avenue  
Dee Why West, NSW 2099  
AUSTRALIA  
TEL: (02) 9982 8266

#### NEW ZEALAND

**Roland Corporation (NZ) Ltd.**  
97 Mt. Eden Road, Mt. Eden,  
Auckland 3, NEW ZEALAND  
TEL: (09) 3098 715

### CENTRAL/LATIN AMERICA

#### ARGENTINA

**Instrumentos Musicales S.A.**  
Florida 656 2nd Floor  
Office Number 206A  
Buenos Aires  
ARGENTINA, CP1005  
TEL: (54-11) 4-393-6057

#### BRAZIL

**Roland Brasil Ltda.**  
R. Coronel Octaviano da Silveira  
203 05522-010  
Sao Paulo BRAZIL  
TEL: (011) 3743 9377

#### CHILE

**Comercial Fancy S.A.**  
Avenida Rancagua #0330  
Providencia Santiago, CHILE  
TEL: 56-2-373-9100

#### EL SALVADOR

**OMNI MUSIC**  
75 Avenida Notre y Alameda  
Juan Pablo 2 No. 4010  
San Salvador, EL SALVADOR  
TEL: (503) 262-0788

#### MEXICO

**Casa Veerkamp, s.a. de c.v.**  
Av. Toluca No. 323 Col. Olivar de  
los Padres 01780 Mexico D.F.  
MEXICO  
TEL: (525) 668 04 80

**La Casa Wagner de  
Guadalajara s.a. de c.v.**  
Av. Corona No. 202 S.J.  
Guadalajara, Jalisco Mexico  
C.P. 44100 MEXICO  
TEL: (3) 613 1414

#### PANAMA

**Productos Superiores, S.A.**  
Apartado 655 - Panama 1  
REP. DE PANAMA  
TEL: (507) 270-2200

#### URUGUAY

**Todo Musica**  
Cuareim 1488, Montevideo,  
URUGUAY  
TEL: 5982-924-2335

#### VENEZUELA

**Musicaland Digital C.A.**  
Av. Francisco de Miranda,  
Centro Parque de Cristal, Nivel  
C2 Local 20 Caracas  
VENEZUELA  
TEL: (02) 285 9218

### EUROPE

#### AUSTRIA

**Roland Austria GES.M.B.H.**  
Siemensstrasse 4, P.O. Box 74,  
A-6063 RUM, AUSTRIA  
TEL: (0512) 26 44 260

#### BELGIUM/HOLLAND/ LUXEMBOURG

**Roland Benelux N. V.**  
Houtstraat 3 B-2260 Oevel  
(Westerlo) BELGIUM  
TEL: (014) 575811

#### DENMARK

**Roland Scandinavia A/S**  
Nordhavnsvej 7, Postbox 880  
DK-2100 Copenhagen  
DENMARK  
TEL: (039)16 6200

#### FRANCE

**Roland France SA**  
4, Rue Paul Henri SPAAK  
Parc de l'Esplanade F 77 462 St.  
Thibault Lagny Cedex FRANCE  
TEL: 01 600 73 500

#### FINLAND

**Roland Scandinavia As,  
Filial Finland**  
Lauttasarentie 54 B  
Fin-00201 Helsinki, FINLAND  
TEL: (9) 682 4020

#### GERMANY

**Roland Elektronische  
Musikinstrumente  
Handelsgesellschaft mbH.**  
Oststrasse 96, 22844 Norderstedt,  
GERMANY  
TEL: (040) 52 60090

#### GREECE

**STOLLAS S.A.**  
**Music Sound Light**  
155, New National Road  
26422 Patras, GREECE  
TEL: 061-435400

#### HUNGARY

**Intermusica Ltd.**  
Warehouse Area 'DEPO' Pl.83  
H-2046 Torokbalint, HUNGARY  
TEL: (23) 511011

#### IRELAND

**Roland Ireland**  
Audio House, Belmont Court,  
Donnybrook, Dublin 4,  
Republic of IRELAND  
TEL: (01) 2603501

#### ITALY

**Roland Italy S. p. A.**  
Viale delle Industrie, 8  
20020 Arese Milano, ITALY  
TEL: (02) 937-78300

#### NORWAY

**Roland Scandinavia Avd.  
Kontor Norge**  
Lilleakerveien 2 Postboks 95  
Lilleaker N-0216 Oslo  
NORWAY  
TEL: 273 0074

#### POLAND

**P. P. H. Brzostowicz**  
U.L. Gibraltarska 4,  
PL-03664 Warszawa POLAND  
TEL: (022) 679 44 19

#### PORTUGAL

**Tecnologias Musica e Audio,  
Roland Portugal, S.A.**  
RUA SANTA CATARINA  
131 - 4000 Porto-PORTUGAL  
TEL: (02) 208 44 56

#### ROMANIA

**FBS LINES**  
Plata Libertatii 1,  
RO-4200 Cheorgheni  
TEL: (066) 164-609

#### RUSSIA

**Slami Music Company**  
Sadovaya-Triumfalnaya st., 16  
103006 Moscow, RUSSIA  
TEL: 095 209 2193

#### SPAIN

**Roland Electronics  
de España, S. A.**  
Calle Bolivia 239 08020 Barcelona,  
SPAIN  
TEL: (93) 308 1000

#### SWEDEN

**Roland Scandinavia A/S  
SWEDISH SALES OFFICE**  
Danvik Center 28, 2 tr.  
S-131 30 Nacka SWEDEN  
TEL: (08) 702 0020

#### SWITZERLAND

**Roland (Switzerland) AG  
Musitronic AG**  
Gerberstrasse 5, CH-4410 Liestal,  
SWITZERLAND  
TEL: (061) 921 1615

#### UKRAINE

**TIC-TAC**  
Mira Str. 19/108  
P.O. Box 180  
295400 Munkachevo, UKRAINE  
TEL: (03131) 414-40

#### UNITED KINGDOM

**Roland (U.K.) Ltd.**  
Atlantic Close, Swansea  
Enterprise Park SWANSEA  
SA7 9FJ,  
UNITED KINGDOM  
TEL: (01792) 700139

### MIDDLE EAST

#### BAHRAIN

**Moon Stores**  
Bab Al Bahrain Road,  
P.O. Box 20077  
State of BAHRAIN  
TEL: 211 005

#### CYPRUS

**Radex Sound Equipment Ltd.**  
17 Diagorou St., P.O. Box 2046,  
Nicosia CYPRUS  
TEL: (02) 453 426

#### ISRAEL

**Halilit P. Greenspoon &  
Sons Ltd.**  
8 Retzif Fa'aliya Hashveta St.  
Tel-Aviv-Yabo ISRAEL  
TEL: (03) 6823666

#### JORDAN

**AMMAN Trading Agency**  
Prince Mohammed St. P.O. Box  
825 Amman 11118 JORDAN  
TEL: (06) 4641200

#### KUWAIT

**Easa Husain Al-Yousifi**  
P.O. Box 126 Safat 13002  
KUWAIT  
TEL: 5719499

#### LEBANON

**A. Chahine & Fils**  
P.O. Box 16-5857 Gergi Zeidan St.  
Chahine Building, Achrafieh  
Beirut, LEBANON  
TEL: (01) 335799

#### OMAN

**OHI Electronics & Trading  
Co. LLC**  
P.O. Box 889 Muscat  
Sultanate of OMAN  
TEL: 959085

#### QATAR

**Badie Studio & Stores**  
P.O. Box 62,  
DOHA QATAR  
TEL: 423554

#### SAUDI ARABIA

**aDawlah Universal  
Electronics APL**  
P.O. Box 2154 ALKHOBAR 31952,  
SAUDI ARABIA  
TEL: (03) 898 2081

#### SYRIA

**Technical Light & Sound  
Center**  
Khaled Ibn Al Walid St.  
P.O. Box 13520  
Damascus - SYRIA  
TEL: (011) 2235 384

#### TURKEY

**Barkat Musik aletleri ithalat  
ve ihracat limited ireketi**  
Siraselviler Cad. Billurcu Sok.  
Mucadelle Cikmeze No. 11-13  
Taksim, Istanbul, TURKEY  
TEL: (0212) 2499324

#### U.A.E.

**Zak Electronics & Musical  
Instruments Co.**  
Zabeel Road, Al Sherooq Bldg.,  
No. 14, Grand Floor DUBAI  
U.A.E.  
P.O. Box 8050 DUBAI U.A.E.  
TEL: (04) 360715

### NORTH AMERICA

#### CANADA

**Roland Canada Music Ltd.  
(Head Office)**  
5480 Parkwood Way Richmond  
B. C., V6V 2M4 CANADA  
TEL: (0604) 270 6626

**Roland Canada Music Ltd.  
(Toronto Office)**  
Unit 2, 109 Woodbine Downs  
Blvd, Etobicoke, ON  
M9W 6Y1 CANADA  
TEL: (0416) 213 9707

#### U. S. A.

**Roland Corporation U.S.**  
5100 S. Eastern Avenue  
Los Angeles, CA 90040-2938,  
U. S. A.  
TEL: (323) 890 3700



This product complies with the requirements of European Directives EMC 89/336/EEC and LVD 73/23/EEC.

For EU Countries

## FEDERAL COMMUNICATIONS COMMISSION RADIO FREQUENCY INTERFERENCE STATEMENT

This equipment has been tested and found to comply with the limits for a Class B digital device, pursuant to Part 15 of the FCC Rules. These limits are designed to provide reasonable protection against harmful interference in a residential installation. This equipment generates, uses, and can radiate radio frequency energy and, if not installed and used in accordance with the instructions, may cause harmful interference to radio communications. However, there is no guarantee that interference will not occur in a particular installation. If this equipment does cause harmful interference to radio or television reception, which can be determined by turning the equipment off and on, the user is encouraged to try to correct the interference by one or more of the following measures:

- Reorient or relocate the receiving antenna.
- Increase the separation between the equipment and receiver.
- Connect the equipment into an outlet on a circuit different from that to which the receiver is connected.
- Consult the dealer or an experienced radio/TV technician for help.

Unauthorized changes or modification to this system can void the users authority to operate this equipment.  
This equipment requires shielded interface cables in order to meet FCC class B Limit.

For the USA

## NOTICE

This Class B digital apparatus meets all requirements of the Canadian Interference-Causing Equipment Regulations.

For Canada

## AVIS

Cet appareil numérique de la classe B respecte toutes les exigences du Règlement sur le matériel brouilleur du Canada.



 Roland®

**71561123**

UPC

71561123

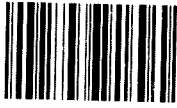

10981