

# **BOSS**

## **DD-2** Digital Delay INSTRUCTIONS

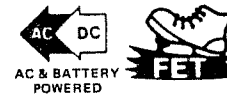

- Please read these instructions carefully for proper operating procedures for the BOSS DD-2.

## CAUTIONS

- When you do not use the unit for a long period, remove the battery to prevent current leakage and leaking of sticky substance.
- When battery voltage drops, effect becomes inferior or no sound is produced. To prevent that, replace the battery a little earlier.
- Be sure to keep the battery snapped by connector into the housing, when using AC adaptor, too.
- \*Even if AC Adaptor cord comes out during performance, operations immediately changes to battery, causing no trouble in continuing performance.
- Power is switched on while a plug is put into input jack. When you do not use, keep the plug off the jack.

## AC ADAPTOR (OPTION)

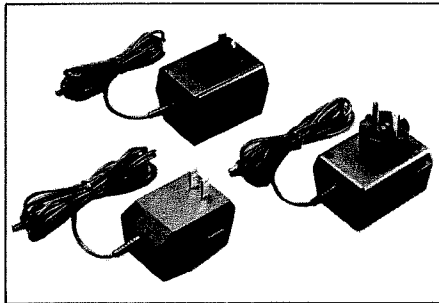

- For AC operation, be sure to use the BOSS AC Adaptor PSA-120, 220 or 240 depending on the voltage system in your country, and never use one Adaptor for two units simultaneously.

## CAUTIONS FOR REPLACING AND HANDLING BATTERY

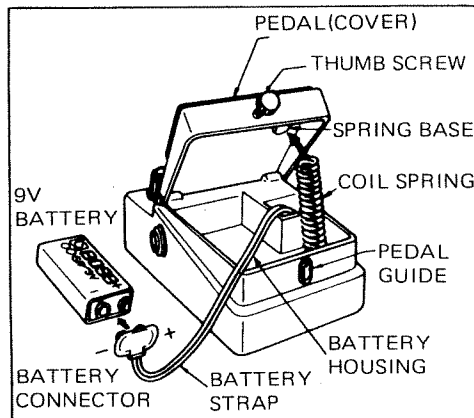

### REPLACING BATTERY USE ONE 9-VOLT BATTERY.

- 1 Loosen the screw of pedal to open it and take out battery from its housing.
- 2 Replace the battery by a new one and put it into position.
- 3 Set coil spring onto the SPRING BASE on the back of the pedal and shut the cover (pedal). Finally, insert the screw into the pedal guide and tighten it. At this time, be careful not to catch the battery strap in the cover or coil spring.

## FEATURES

- The DD-2 is the first compact digital delay. The DD-2 allows wider range of delay time (12.5ms to 800ms) and frequency response (40Hz to 7kHz/  $+1$ / $-3$  dB) than conventional analog system one.
- The Pedal Switch has double duty of Effect ON/OFF and Hold ON/OFF. Hold Effect is made attainable by its digital system.
- 2 Output system allows to select Mono or Stereo out.

## NOTICE

- Please be sure to use the AC Adaptor BOSS PSA-series depending on the voltage system in your country. ACA-series can not be used, as the DD-2 consumes more current (55mA 9V DC) than usual compact effect units.
- The battery (one Dry Battery, 9V) will last for 30 minutes to 2 hours (manganese) or 5 to 10 hours (alkaline), depending on the conditions. The use of a BOSS PSA-Adaptor is recommended for a long time performance.
- Avoid using this unit in extreme heat or humidity, or where it may be affected by dust.

## SPECIFICATIONS

POWER	9V DC Dry Battery, AC ADAPTOR (PSA-120, 220 or 240)
CURRENT DRAW	45mA ~ 65mA (9V DC)
CONTROLS	EFFECT LEVEL, FEEDBACK, DELAY TIME, MODE SELECTOR SWITCH
OTHERS	NORMAL/EFFECT CHANGEOVER (HOLD ON/OFF) FOOT SWITCH
JACKS	INPUT, DIRECT OUTPUT, MAIN OUTPUT
SYSTEM	AC ADAPTOR (PSA-120, 220 or 240) ANALOG LOGARITHMIC COMPRESSION AND 12 BITS QUANTIZING SYSTEM
DELAY TIME	12.5ms(MIN) to 800ms(MAX) S(SHORT) 50ms (12.5ms to 50ms) M(MIDDLE) 200ms (50ms to 200ms) L(LONG) 800ms (200ms to 800ms)
HOLD TIME	200ms(MIN) to 800ms(MAX) in Hold mode
FREQUENCY RESPONSE	DELAY SOUND: 40Hz to 7kHz/ $+1$ / $-3$ dB DIRECT SOUND: 10Hz to 60kHz/ $+1$ / $-3$ dB
RESIDUAL NOISE	- 95dBm(1HF-A)
INPUT IMPEDANCE	1M $\Omega$
OUTPUT LOAD IMPEDANCE	10k $\Omega$ or more
DIMENSIONS	70(W)x55(H)x125(D)mm/ 2-3/4(W)x2-3/16(H)x5(D)in.
WEIGHT	450g/1 lb.

\*The specifications are subject to change without notice.

## CONNECTING

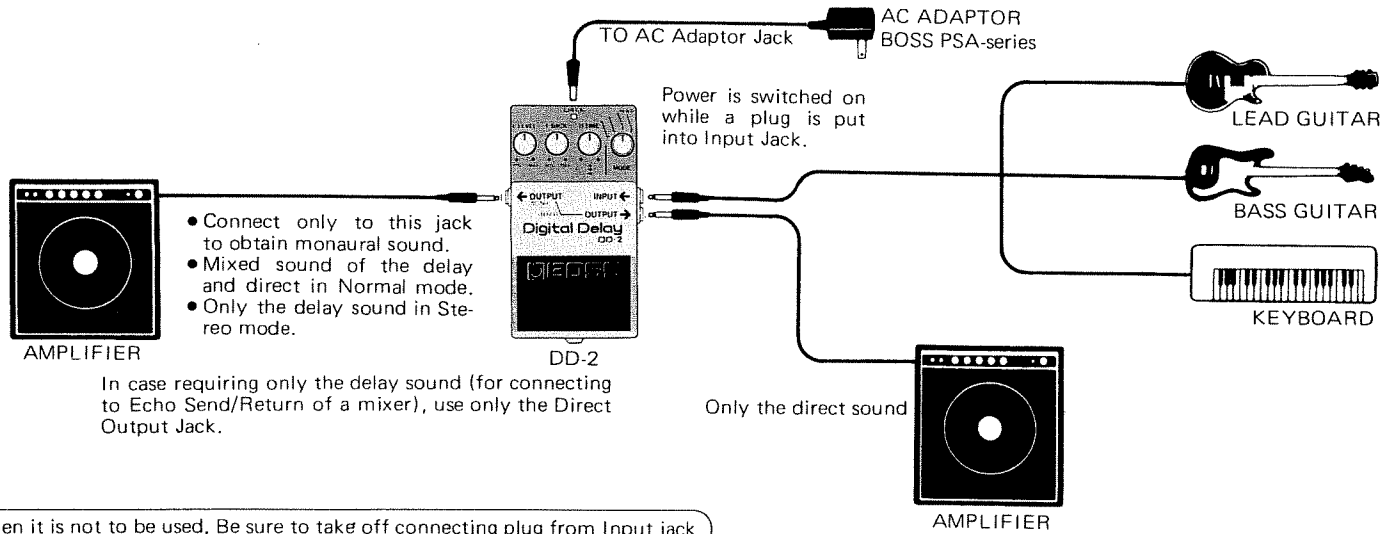

## DESCRIPTION

### CHECK INDICATOR

The Check Indicator enables you to confirm if the Effect is ON or OFF, and as well to check the battery. If the Check Indicator lights up by pressing the Pedal Switch down, Delay Effect is on, and if goes out, Delay Effect is OFF (Normal).  
\*Hold Effect works as long as the pedal is held down.  
\*The battery should be replaced, when the indicator lights but only dimly or does not light up at all.

### EFFECT LEVEL

This knob controls the output level of the delay sound. Turning this knob clockwise increases the level of the delay sound. With this knob turned fully counterclockwise, the output level of the delay sound is equivalent to that of the direct sound. Also when this knob is turned fully counterclockwise in Normal mode, only the direct sound is obtained, while no sound is heard from the Main Output in Stereo mode.

### MAIN OUTPUT JACK

Monaural signal (the mixed signal of the direct and delay sounds) is output from this jack. (If the plug is not connected to the Direct Output Jack.)

### FEEDBACK LEVEL

This knob decides how many times the delay sound is to be repeated. Turning this knob clockwise increases the number of repetition of delay sound, and turning this knob fully counterclockwise produces single delay sound.

### DELAY TIME

This knob allows to finely adjust the delay time set with the Mode Selector Switch by from "X 0.25" to "X1" continuously. Turning this knob clockwise increases the delay time, and counterclockwise decreases it.

### INPUT JACK

This jack should be connected to an electric guitar or other musical instrument.  
\*The unit is powered on by plugging to the Input Jack and is powered OFF by unplugging.  
\*By muting circuit system no Effect works for about 5 seconds after the unit is powered on.

### DIRECT OUTPUT JACK

When a plug is connected to this jack, direct sound is output from this jack, and delay sound is output from the Main Output Jack.

### THUMB SCREW

When the battery needs replacing, loosen this screw to open the pedal and replace the battery with a new one.  
\*The screw should not be pulled out, but if needs removing for some reason, do not lose it.

### AC ADAPTOR JACK

The AC-adaptor (BOSS PSA-120, 220 or 240) should be connected to this jack.  
\*BOSS ACA-series must not be connected, use specifically PSA-series.

### MODE SELECTOR SWITCH

The Mode Selector Switch has 4 modes, S, M, L, and Hold. The delay time changes from 12.5ms to 800ms continuously by using this selector and the Delay Time knob. In Hold mode, the Delay Time knob controls the repetition time of the hold sound from 200ms to 800ms. The Pedal Switch works as long as the pedal is held down.

### PEDAL SWITCH

The Pedal Switch works as Delay Effect ON/OFF or Hold ON/OFF switch.  
\*Due to FET-switching system, audible click noise problem is solved, thus the DD-2 is most suitable for studio recording.

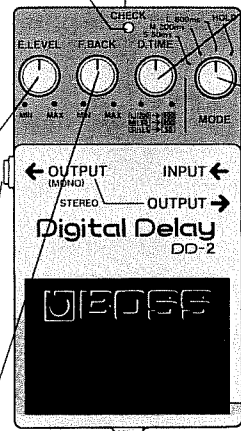

## OPERATION

### (1) DELAY(ECHO) EFFECT

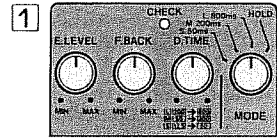

After connecting all the cords required, set all the knobs on the panel as illustrated.



When the Check Indicator lights up by pressing the Pedal Switch down, Delay Effect is ON, and if goes out, Delay Effect is OFF.

\*By muting circuit system no effect works for about 5 seconds after the unit is powered on.

\*This indicator serves as Battery Check Indicator as well. The battery should be replaced with a new one when the indicator lights only dimly or fails to light up.

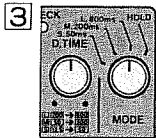

Select the range of delay time with the Mode Selector Switch, and then adjust the Delay Time by rotating the Delay Time knob.

\*High-frequency input signal can cause beat notes, making Delay sound muddy. Slight counterclockwise rotation of D. TIME will decrease beats.



Adjust the repetition time by setting the Feedback knob to a proper position.

\*If this knob is set too high, oscillation may occur.



Adjust the output level of delay sound. \*Turning the knob to MAX makes the level of delay sound equivalent to the direct sound.

\*When this knob is set to MIN in stereo mode, the delay sound is not output through the Main Output.

### (2) HOLD EFFECT

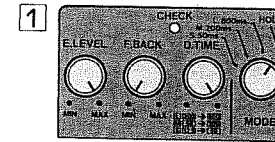

After connecting all the cords required, set the all knobs on the panel as illustrated.

\* Feedback Effect does not work with Hold effect ON.



When the Check Indicator lights up by pressing the Pedal Switch down, Hold is ON. If it goes out by pressing the Pedal Switch down, Hold is OFF (Normal).

\*When you press the Pedal Switch down after playing some phrases, the last sound played will take on the Hold effect.

\*The Pedal Switch works as long as the pedal is held down.

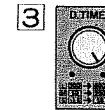

The delay time knob adjust the Hold Time (200ms to 800ms). When you rotate this knob while the hold sound is heard, its pitch changes; rotating it clockwise lowers the pitch and counterclockwise raises it.

 **BOSS**  
Products of Roland

Printed in Japan Apr. '84 E-3

 Roland®

---

**10268**

UPC 10268



10901

 **BOSS**