

 Roland®

HS-60

Owner's Manual
Part 1&2

SynthPlus 60

PROGRAMMABLE POLYPHONIC SYNTHESIZER HS-60

Owner's Manual

Part 1

This manual explains how to use the preprogrammed patches of the HS-60. To synthesize your own sounds, read the Operation Manual Part 2.

Read the manual before using the HS-60. And if you want to know more about the HS-60, read the Operation Manual Part 2.

- The Roland HS-60 is a 61 key, 6 voice fully programmable synthesizer.

FEATURES

- The Digitally Controlled Oscillator (DCO) guarantees an extremely stable pitch.
- The HS-60 is a complete 6 voice synthesizer that is provided with 6 VCFs, 6 VCAs and 6 ENVs.
- The HS-60 features memory capacity that can retain up to 128 different patch programs.
- This features battery back-up system that retains the data in memory even when switched off.
- 2 amplifiers of 8W maximum outputs and speakers are built in.
- By connecting a pedal switch to the Patch Shift jack on the HS-60, you can sequentially call the 8 patch programs stored in the same bank.
- The Expression Pedal Jack allows more dynamic performance.
- Transposition to any key is possible.
- The Portamento function allows a sweep from a pitch to another.
- The Chorus effect produces rich and expansive sounds.
- Featured with MIDI Connectors, the HS-60 can be set up with any MIDI device.

SynthPlus 60
PROGRAMMABLE POLYPHONIC SYNTHESIZER HS-60

1 PANEL DESCRIPTIONS

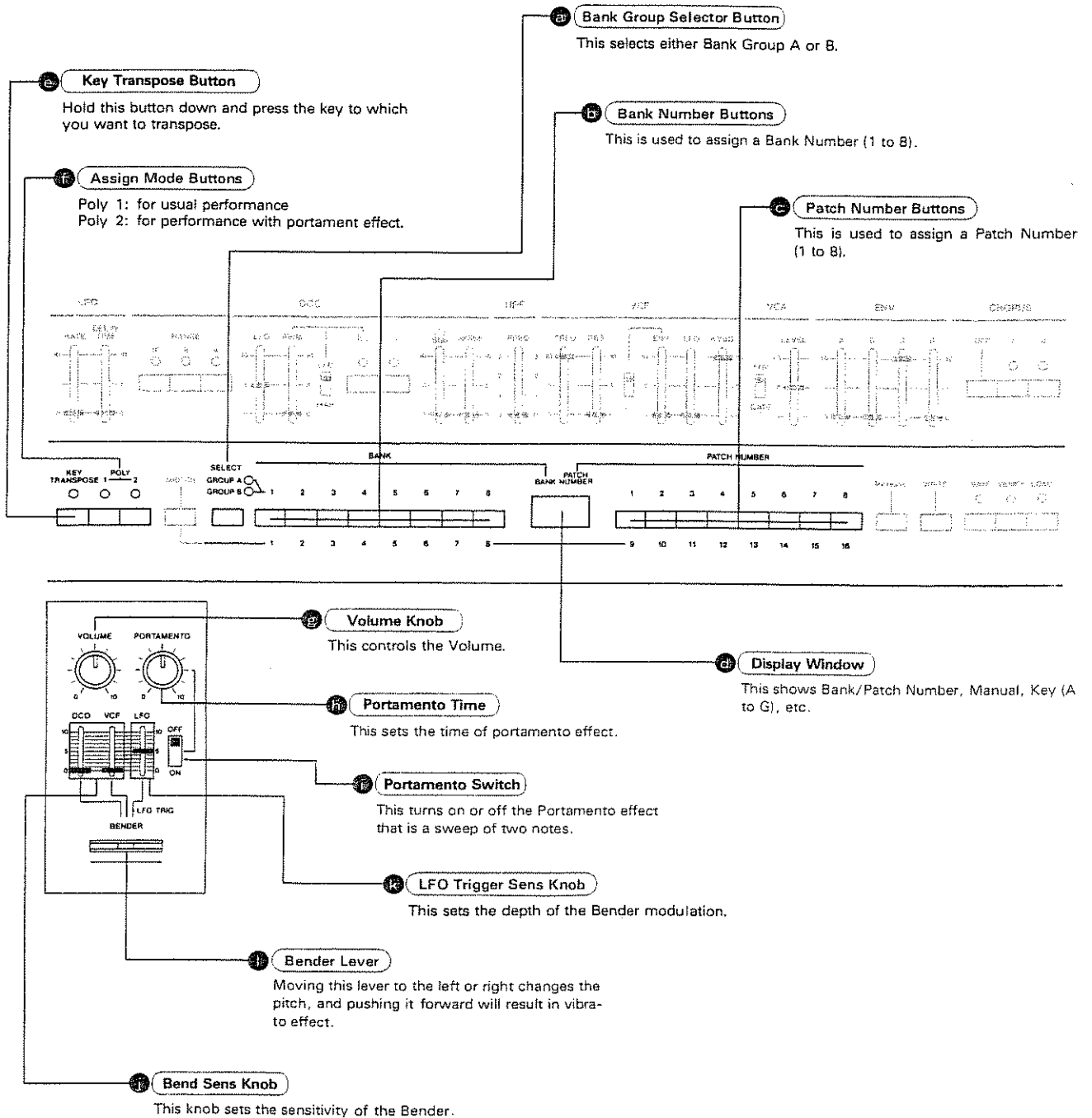

IMPORTANT NOTES

POWER SUPPLY

- The appropriate power supply for this unit is shown on its name plate. Please make sure that the line voltage in your country meets that.
- When setting up the HS-60 with an external amplifier, turn both of them off, plug the HS-60 in first, then the amplifier.
- This unit might not work properly when turned on immediately after turned off. If this happens, simply turn it off, and turn it on again in a few seconds.
- This unit might get hot while operating, but there is no need to worry about it.

LOCATION

- Operating the HS-60 near a neon or fluorescent lamp may cause noise interference. If so, change the angle or position of the HS-60.
- Avoid using the HS-60 in excessive heat or humidity or where it may be affected by direct sunlight or dust.

CLEANING

- Clean the unit with only soft cloth and neutral detergent.
- Do not use solvents such as THINNER.

- The HS-60 is a 6 voice synthesizer, therefore if 6 keys are simultaneously pressed, no more key will sound.
- If you play a chord on the HS-60 with its highest volume, some tone color may sound distorted, but there is no need to worry about it. Simply turn down the volume. (When an external amplifier is used, the sound sent from the Output will not be distorted.)
- The HS-60's memory back-up system is fully supported by a battery. Normally, the battery replacement is required every five years, but the first replacement may be needed even before that depending how many months had passed before you bought it. Please ask for your local Roland dealer for replacement.

2 CONNECTION

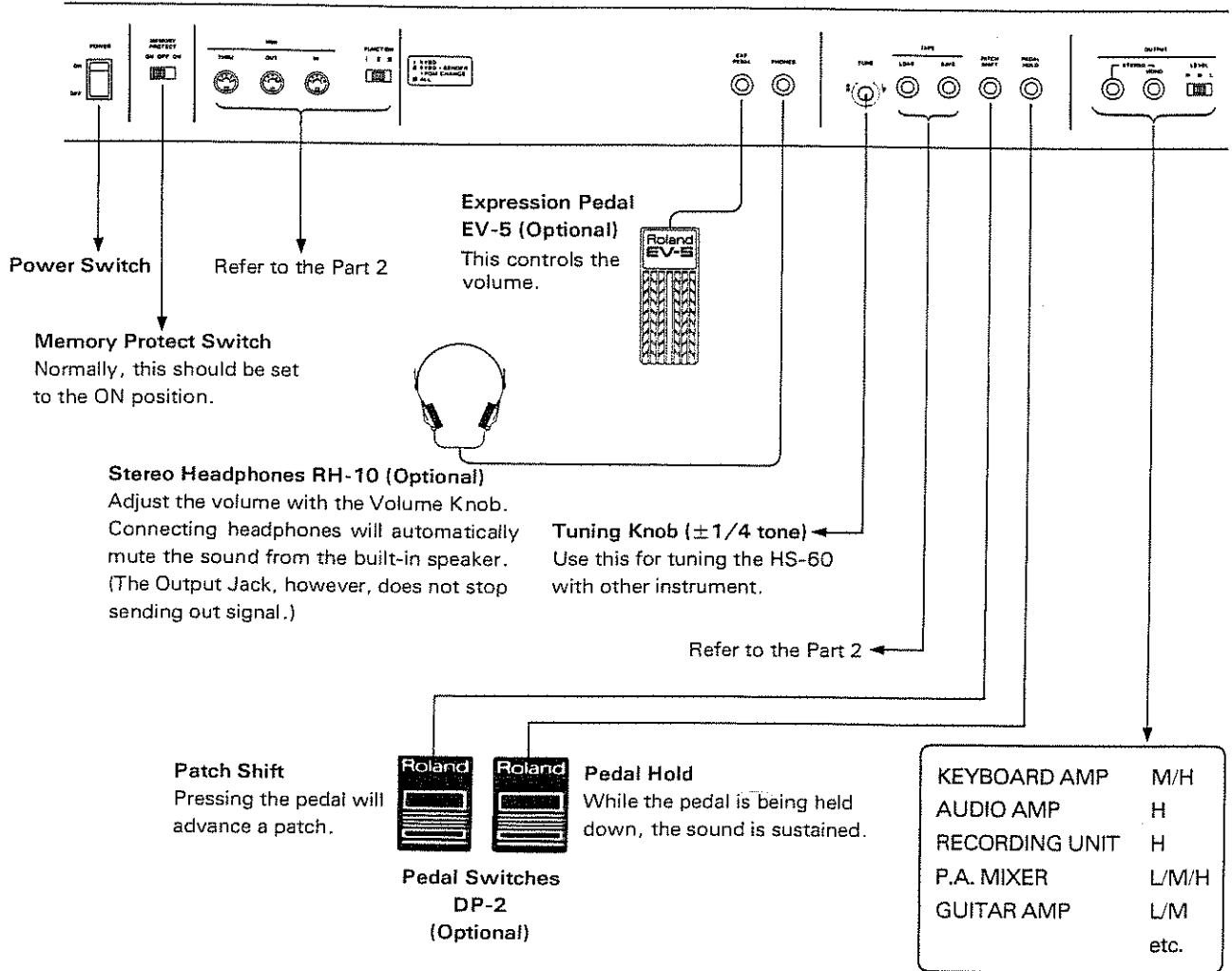

Music Rest

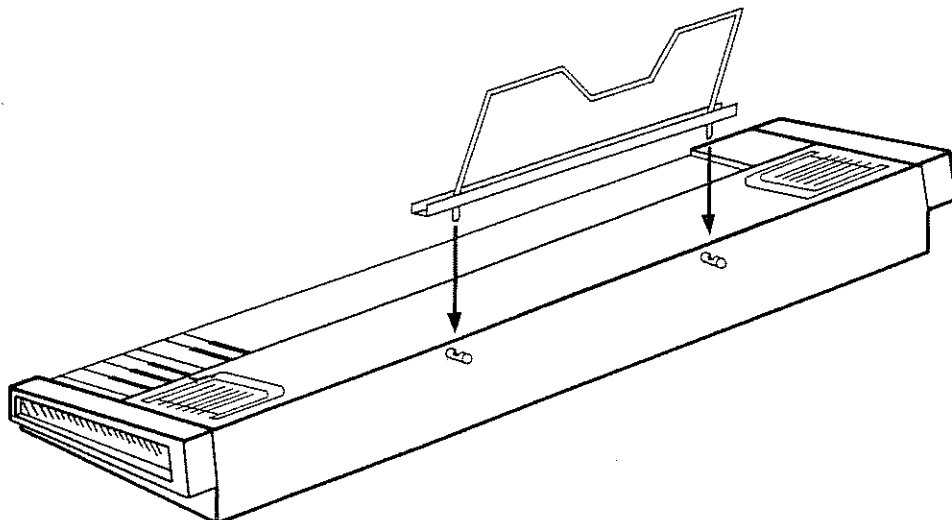

③ OPERATION

BASIC OPERATION

1. Make sure that the Memory Protect Switch on the rear panel is set to the ON position.

2. Turn the HS-60 on.

3. Select a tone color you like as follows.

There are 128 different tone colors (8 Patches × 8 Banks × 2 Groups) preprogrammed in the HS-60 ready to be used just by pressing Bank Group Button, Bank Number Button and the Patch Number Button.

- ① Select either Bank Group A or B by using the Bank Group Selector Button **a**.
- ② Select a Bank Number (1 to 8) by using the Bank Number Button **b**.
- ③ Select the Patch Number (1 to 8) by using the Patch Number Button **c**.

The Bank Number and Patch Number will be shown in the Display Window.

* Repeat steps ① to ③ as many times.

* The Patch Number can be changed by using a pedal switch instead of taking step ③. (Refer to page 5.)

4. Adjust the volume as you play the keyboard.

MEMORY PROTECT
ON OFF ON



POWER



SELECT
GROUP A ○
GROUP B ○



BANK

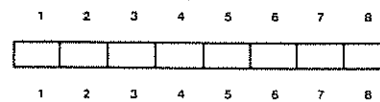

PATCH NUMBER

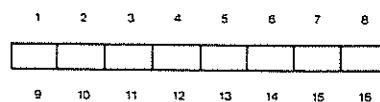

VOLUME

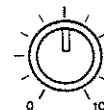

■ Memory (Locations for Tone Colors)

The memory system of the HS-60 is as shown right. Each Bank Group consists of 8 Banks, and each Bank consists of 8 patch programs. That is, 64 (8 × 8) different patch programs are written in each Bank Group, thereby total of 128 tone colors are available.

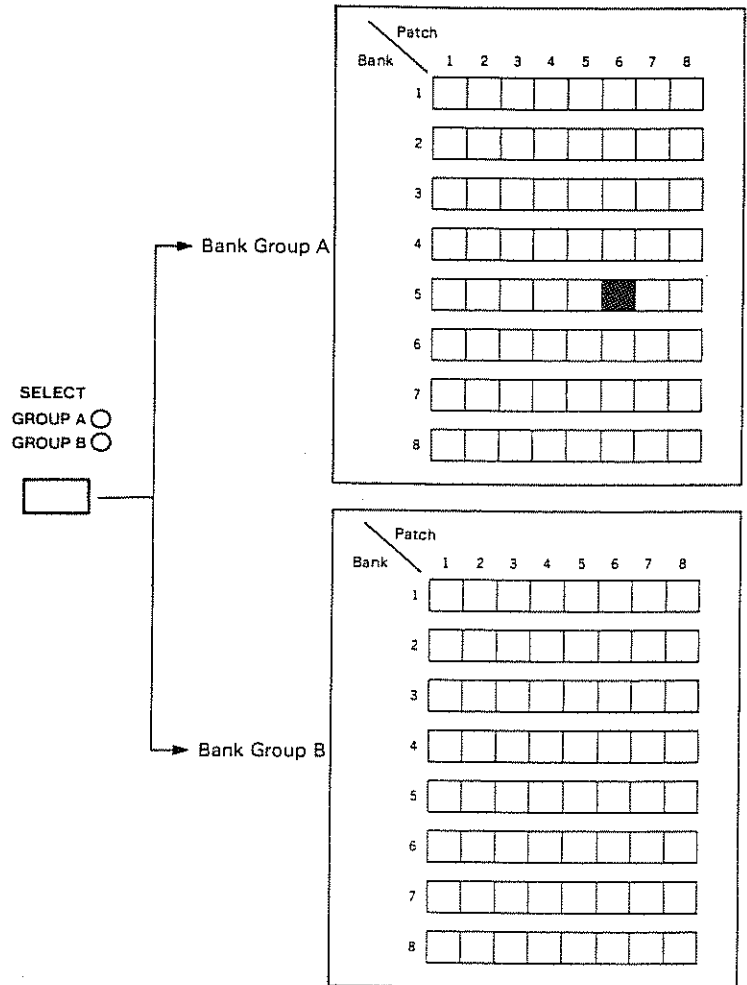

■ represents patch program 5-6 in Pattern Group A

► Example

- B-23 (Bank Group B, Bank 2, Patch 3)

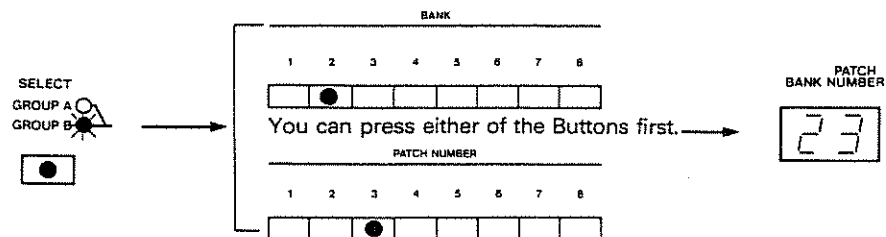

PERFORMANCE CONTROL SECTION

a. ASSIGN MODE

The HS-60 has 6 separate sound modules which work differently depending how you set the Assign mode.

► POLY 1 & 2

This mode turns the HS-60 to a 6 voice synthesizer assigning one synthesizer module to each key pressed. Select Poly 1 mode for usual performance, and Poly 2 for the performance with portamento effect.

► SOLO UNISON

This mode turns the HS-60 to a monophonic synthesizer that assigns 6 modules to only one key pressed.

b. PORTAMENTO

Portamento effect is a sweep of two notes you play. This is a manner often used for playing the violin.

c. BENDER CONTROL

The Bender Lever  allows to change pitch or tone color or obtain vibrato effect.

► DCO Bend Sens

This determines the maximum effect of the pitch alteration caused by Bender Lever. (Max. ± 1 octave.)

► VCF Bend Sens

This determines the maximum effect of the tone color alteration caused by Bender Lever.

Operation

► POLY 1

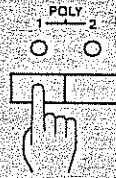

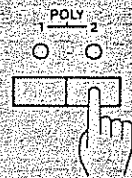

► POLY 2

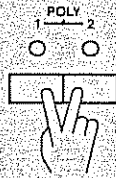

► SOLO UNISON



Operation

- ① Turn on the Portamento Switch .
- ② Set the Portamento time to your taste by rotating the Portamento Time Knob .

► LFO Trigger Sens

This sets the depth of the vibrato effect caused by pushing the Bender Lever forward.

* Adjust the rate of the vibrato with the LFO Rate Knob. (Refer to the Part 2.)

Operation

As you push the Bender Lever forward, adjust each knob.

d. KEY TRANSPOSE

By using the appropriate key, you can shift the pitch of the entire keyboard up to \pm one octave. Therefore, music with many \sharp 's and \flat 's can be played in the key of C major (=A minor).

Operation

- 1 Push the Key Transpose Button .

The Display Window will show Middle C (C).

- 2 While still holding the Key Transpose Button, press the key which you wish to transpose to.

The Key Transpose Indicator lights up and transposition is completed. (As long as the Key Transpose Button is pressed, the Display shows the current key name.)

* To return to the normal key (C key), press the Middle C key while holding the Key Transpose Button down.

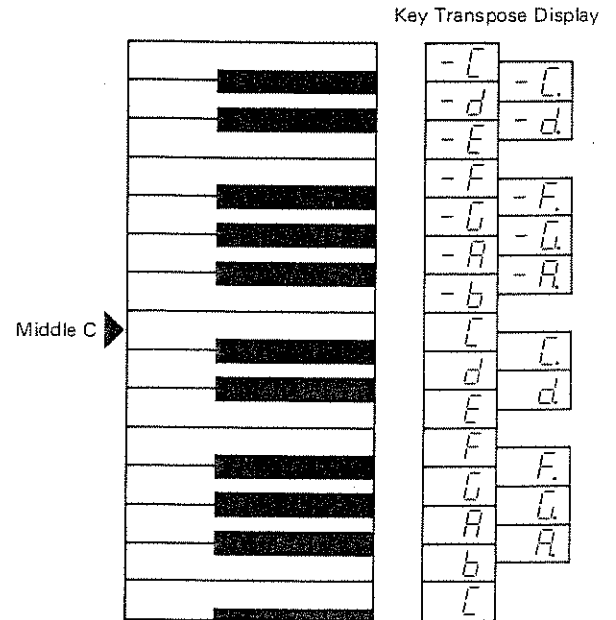

► Example Transposition

How to transpose from the C to A key.

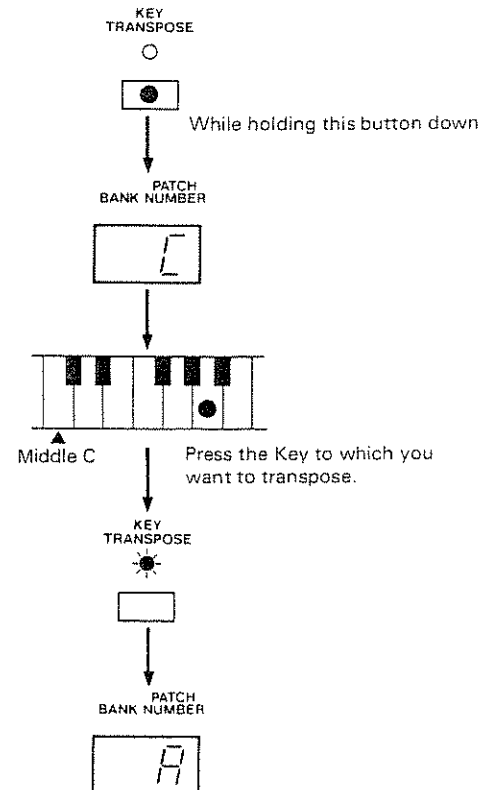

4 SOUND RANGE

Sound Range Table

The HS-60 has a 61 key, 5 octave keyboard, but can be played as a more than 5 octave keyboard by using the Range Switch in the Synthesizer Section, Key Transpose function, Sub Oscillator, etc.

* The patch program 22 in Group A, for instance, has the range of a normal piano with the Range set to 8'. The program 66 has a range of an octave higher, and 81 has a range of an octave lower.

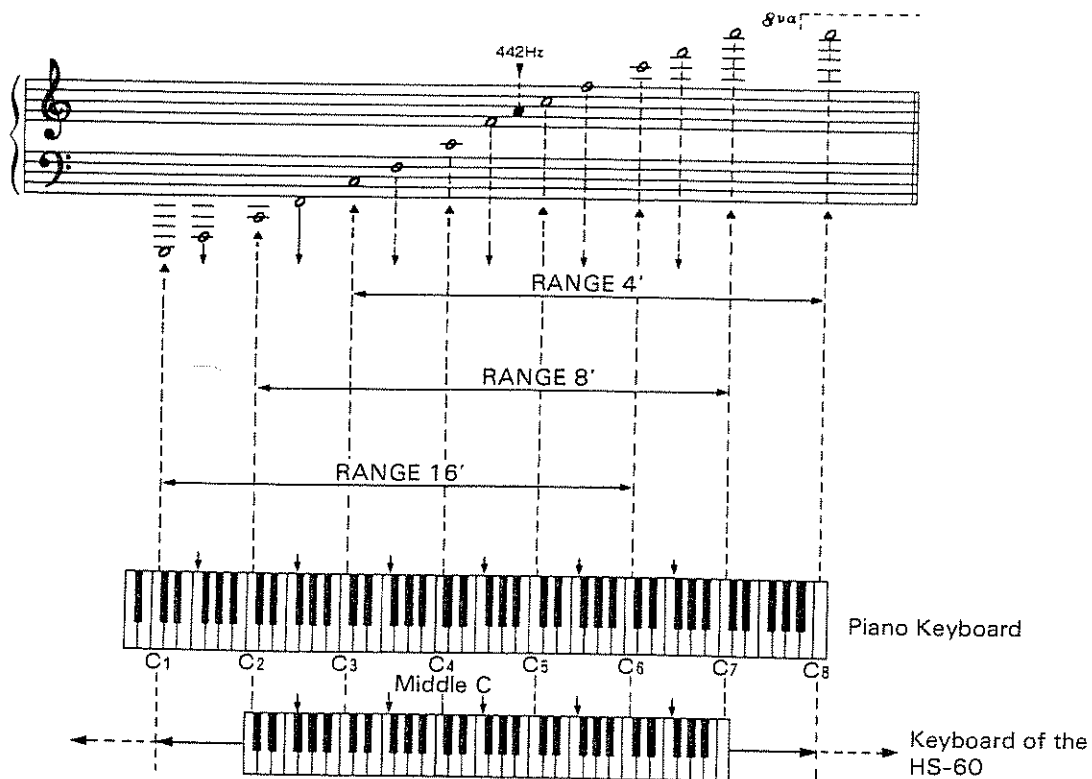

* Maximum Range

If all the Key Transpose (± 1 octave), Bender (± 1 octave) and Vibrato (\pm major third) functions are used simultaneously, and the sound happens to exceed the maximum range, it may not be heard at all or the effect may not be recognized.

PATCH PROGRAM DATA

Group-A

Patch Bank	1	2	3	4	5	6	7	8
1	11 Brass	12 Brass Swell	13 Trumpet	14 Flute	15 Moving Strings	16 Brass & Strings	17 Choir	18 Piano I
2	21 Organ I	22 Organ II	23 Combo Organ	24 Calliope	25 Donald Pluck	26 Celesta *	27 Electric Piano I	28 Electric Piano II
3	31 Clock Chimes *	32 Steel Drums	33 Xylophone	34 Brass II	35 Fanfare	36 String III	37 Pizzicato	38 High Strings
4	41 Bass Clarinet	42 English Horn	43 Brass Ensemble	44 Guitar	45 Koto	46 Dark Pluck	47 Funky I	48 Synth Bass I
5	51 Lead I	52 Lead II	53 Lead III	54 Funky II	55 Synth Bass II	56 Funky III	57 Thud-Wah	58 Going up
6	61 Piano II	62 Clav.	63 Frontier Organ	64 Snare Drum	65 Tom Tom	66 Timpani	67 Shaker	68 Synth Pad
7	71 Sweep I	72 Pluck Sweep	73 Repeater	74 Sweep II	75 Pluck Bell	76 Dark Synth Piano	77 Sustainer	78 Wah Release
8	81 Gong	82 Resonance Funk	83 Drum Boom *	84 Dust Storm	85 Rocket Men	86 Hand Clap	87 FX Sweep	88 Caverns

26. 1 oct. up

31. 1 oct. up

48. unison

64. unison

65. unison

66. unison

81. play low chords

83. 1 oct. down

* key transpose





Group-B

Patch Bank	1	2	3	4	5	6	7	8
1	11 Strings	12 Hammer Ball	13 Machine Gun	14 Take Off	15 Scramble	16 Paralyzer	17 Space Colony	18 Day After
2	21 Filter Flow	22 Gyroidal Space	23 Flying Saucer	24 Solaris	25 Space Trampoline	26 Inner Trip	27 Big Wednesday	28 Blizzard
3	31 Flute	32 Clarinet	33 Oboe & Fagotto	34 Funky Wood	35 Voice	36 Accordion	37 Pizzicato Dream	38 Funky Bass
4	41 Jazz Organ I	42 Jazz Organ II	43 Pipe Organ	44 Synth Organ	45 Chorus Organ	46 Chief Organ	47 Funky Organ	48 Synth Bass II
5	51 Clav.	52 Harpichord	53 Harp	54 Koto	55 Taishou Koto	56 Chorus Piano	57 Bell Chimes	58 Synth Bass I
6	61 Electric Piano	62 Wood	63 Tremolo Piano	64 Star Chime	65 Steel Drums	66 Resonance Piano	67 Coupler Piano	68 Soft Bass
7	71 Violin	72 Violin & Viola	73 Cello & Contrabass	74 Bright Strings	75 Middle Strings	76 Lower Strings	77 Pulse Width Strings	78 Pulse Width Brass
8	81 High Note Trumpet	82 Middle Brass	83 Funky Brass	84 Chorus Brass	85 Chorus Horn	86 Tonguing Brass	87 Lower Horn	88 Orchestra Brass

* The patch programs 81 to 88 and 72 in Group A and 12, 35, 64 and 65 in Group B use VCF's oscillation or noise, so do not guarantee accurate pitches. Therefore, these sounds do not match the other preset sounds.

SPECIFICATIONS

● HS-60 (SYNTH PLUS) ● 6 Voice programmable Polyphonic Synthesizer

Keyboard	61 keys, 5 octaves
DCO	LFO Modulation Knob Pulse Width Modulation Knob PWM Mode Switch (LFO/MANUAL) Pulse Wave (ON/OFF) & Indicator } Waveforms Sawtooth (ON/OFF) & Indicator } Range Selector Buttons (16', 8', 4') Sub Oscillator Level Knob Noise Level Knob
HPF	Cutoff Frequency Knob (0/1/2/3)
VCF	Cutoff Frequency Knob Resonance Knob (0~Self Oscillation) ENV Modulation Knob Polarity Switch ( , ) LFO Modulation Knob Key Follow Knob (0~100%)
VCA	Control Signal Selector Switch (ENV  /GATE ) VCA Level Knob
ENV	Attack Time Knob (1.5ms~3s) Decay Time Knob (1.5ms~12s) Sustain Level Knob (0~100%) Release Time Knob (1.5ms~12s)
LFO	Rate Knob (0.1Hz~30Hz) Delay Time Knob (0~3s)
Controllers	Volume Knob Portamento Time Knob Portamento Switch (ON/OFF) LFO Trigger Sens Knob Bend Sens (DCO) Knob Bend Sens (VCF) Knob Bender Lever
Assign Mode	Poly 1/Poly 2 Switches & Indicators
Key Transpose	Key Transpose Button & Indicator
MIDI Channel	MIDI Channel Selector Button
Memory	Patch Number Buttons (1~8) Bank Buttons (1~8) Bank Group Selector Button (A/B) & Indicators Manual Button Write Button Save Button & Indicator Verify Button & Indicator Load Button & Indicator Display Window
Chorus	OFF/I/II Switches & Indicators
Power	Power Switch

Rear panel	Output Jacks (Mono/Stereo) Phones Jack (Stereo) Pedal Hold Jack (DP-2) Patch Shift Jack (DP-2) Save Jack Load Jack Expression Pedal Jack (EV-5) Memory Protect Switch Level Selector Switch (H/M/L) MIDI Function Selector Switch (I, II, III) MIDI IN Connector MIDI OUT Connector MIDI THRU Connector Tune Adjust Knob (± 50 cent)
Main Amplifier	8W \times 2
Speaker	10cm \times 2
Dimensions	992(W) \times 340(D) \times 130(H)mm/ \diagdown 39-1/16" \times 13-3/8" \times 5-1/8" (Dimensions without the music rest)
Weight	15kg/33 lb 2oz
Consumption	50W
Accessories	Music Rest

* Specifications are subject to change without notice.

OPTIONS

- Headphones RH-10



- Expression Pedal (EV-5)

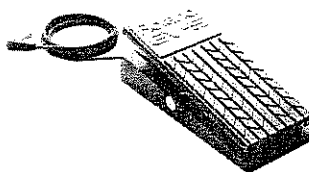

- Pedal Switch DP-2

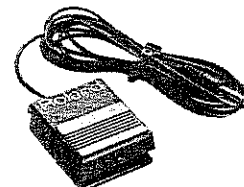

- Stand KS-2

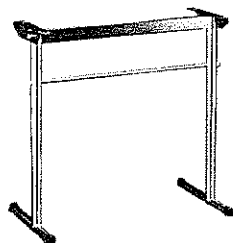

- Carrying Case SC-65

HS-60

Part 1

85-2-E

SynthPlus 60

PROGRAMMABLE POLYPHONIC SYNTHESIZER HS-60

Owner's Manual

Part 2

This manual mainly explains the functions for synthesizing. Please read the separate volume "Part 1", too.

...

Contents

1	Panel Description	3
2	How to Synthesize	5
3	Functions for Sound Creating	18
	DCO	18
	HPF	20
	VCF	20
	VCA	22
	ENV	22
	LFO	23
	CHORUS	23
4	Memory Section	24
	1. Edit	24
	2. Write	25
	3. Copy	28
5	Tape Interface	29
	1. Save	30
	2. Verify	31
	3. Load	32
6	MIDI	34

Sound Samples
MIDI Implementation Chart

Please read the separate volume "MIDI" before this owner's manual.

SynthPlus 60
PROGRAMMABLE POLYPHONIC SYNTHESIZER HS-60

1 Panel Description

- 1 **None Level Knob**
This is the volume knob for another sound source. Noise.
- 2 **Sub-Oscillator Level Knob**
This adjusts the Sub-Oscillator's volume.

- 3 **Waveforms**
You can select the output waveform of the DCO. (Each of them can be switched on and off individually.)
- 4 **PWM Mode Switch**
To select the pulse width controlling signal.
- 5 **Pulse Width Modulation Knob**
<MAN> When the PWM Mode Switch is set to MAN, pulse width rate is pulse width rate. <LFO> When the Sub-Oscillator LFO knob sets the depth of the modulation.

- 6 **LFO Modulation Knob**
It adjusts the depth of the vibrato effect.
- 7 **Range Selector Switches**
These switches are used to shift the range of the keyboard. (1: entire up or down)
- 8 **Delay Time Knob**
This determines the time required for the LFO modulation (Vibrato or Growl effect) to start.

- 9 **HPF Cutoff Frequency Knob**
As you raise the knob, fundamental and low frequency harmonics are out boosted. (The sound is getting brighter and thinner.)
- 10 **Cutoff Frequency Knob**
As you lower the knob, lower frequencies are getting softer.
- 11 **Resonance Knob**
This emphasizes the Cutoff Point creating unusual sound.
- 12 **Porturey Switch**
This determines the polarity of the Envelope. (Normally is polarity is for special effect.)
- 13 **ENV Resolution Knob**
This adjusts the level of the ENV signal which controls the Cutoff Point of the VCF.
- 14 **LFO Modulation Knob**
This adjusts the depth of the growl/wah effect.
- 15 **ENV Resolution Knob**
This determines the polarity of the Envelope. (Normally is polarity is for special effect.)
- 16 **Attack Time Knob**
This controls the time needed for the voltage to reach its maximum level after the key is pressed.
- 17 **Decay Time Knob**
This determines the time needed for the voltage to reach the Sustain level.
- 18 **Sustain Level Knob**
This determines the Sustain level to which the voltage falls at the end of the Decay time.
- 19 **Release Time Knob**
This sets the time required for the sound to finally fade out after the key is released.
- 20 **Channel Mute Switch**
The effect becomes stronger from left to right, but it is stronger than L1. It is not possible to use L and R at the same time.

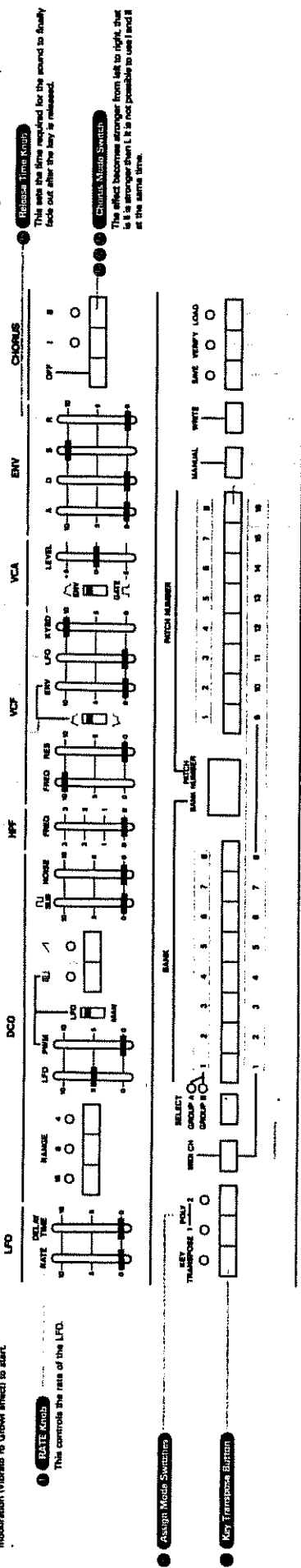

- 21 **Parasitism Time**
- 22 **Volume Knob**
- 23 **Parasitism Switch**
- 24 **Bank Select Knob**
- 25 **LFO Sustain Knob**
- 26 **Assign Mode Switches**
- 27 **Key Transpose Button**
- 28 **Display Window**
This shows Bank/Patch Number, MIDI Channel Number, Memory Address, Memory Protect, Key A to G1, etc.
- 29 **Bank Number**
With the MIDI Channel Button depressed, the Bank Buttons and Patch Number Buttons will serve as MIDI Channel Number Setting Buttons (1 to 16).
- 30 **MIDI Channel Numbers**
With the MIDI Channel Button depressed, the Bank Buttons and Patch Number Buttons will serve as MIDI Channel Number Setting Buttons (1 to 16).
- 31 **Bank Number/MIDI Channel Number Button**
This changes the Channel Numbers (1 to 16).
- 32 **Bank Group Selector Button**
- 33 **MIDI Channel Button**
Pressing this Button will cause the Display Window to show the Channel Number of the selected MIDI Channel. Press an appropriate Bank or Patch Number Button while holding the Button down.
- 34 **Level Button**
The button is used to load the data from tape into the Juno-106's memory.
- 35 **Verify Button**
Press this button when checking the recorded data.
- 36 **Save Button**
Press this button when saving the patch program onto a tape.
- 37 **Write Button**
Press this button when storing a patch program into memory.
- 38 **Manual Button**
Press this button when synthesizing from scratch without using a patch program at all.
- 39 **Patch Number/MIDI Channel Number Button**
This is used to assign a MIDI Channel Number

You can enjoy playing the HS-60 simply by using its preprogrammed tone colors. Synthesizing your own sounds, however, will give you more fun. As you follow the procedures step by step, you will naturally understand what role each control plays. For more logics on synthesizing, see "Functions for Sound Creating" on page 18.

How to look at the pictures

When you see the arrows on both right and left sides, play the keyboard with one hand while moving the knob with the other hand. In this way, you can hear the difference. When only an arrow is shown, simply move the knob to the position.



Example Settings

Securely connect the power cord to the socket, then turn the HS-60 on. Set the controls as shown below.

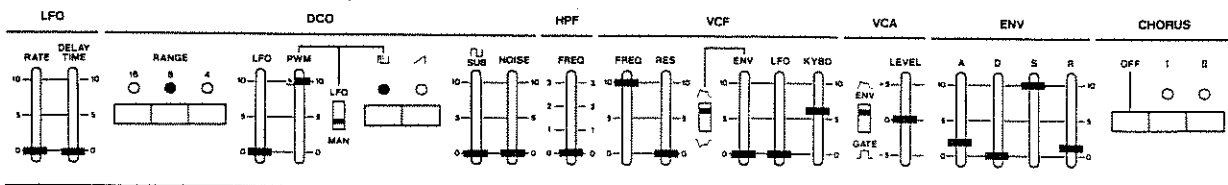

Adjust the volume to a comfortable level by using the Volume Knob. Then, as you play the keyboard, set the knob 7 which is marked PWM as shown below.

only while the indicator of the  switch in the DCO section is lighted. (★1)

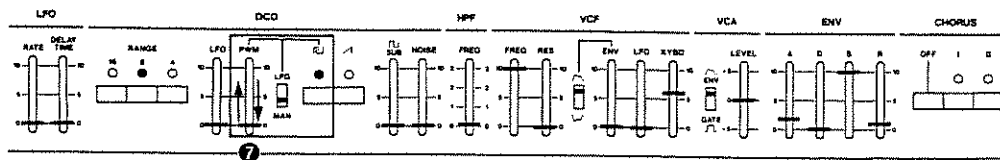

The Freq knob softens or hardens the tone color. (★2)

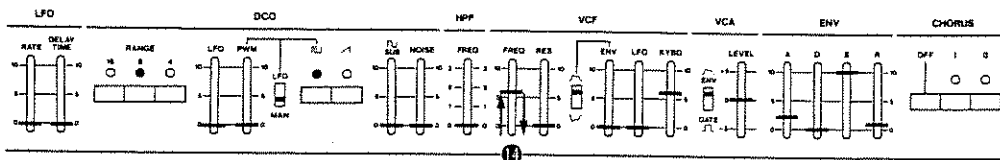

When the knob 1 is set to zero, the knob 6 has no effect at all. Try moving both knobs to see their relation. (★3)

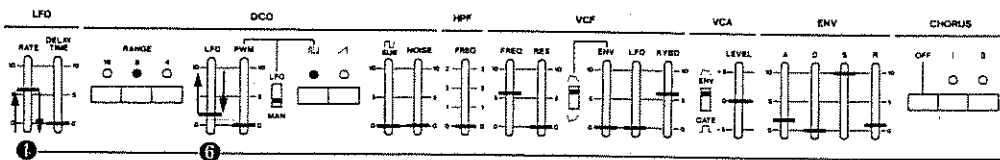

Finally, the setting shown below will produce clarinet like sound. Try adjusting each knob finely for more realistic clarinet sound.

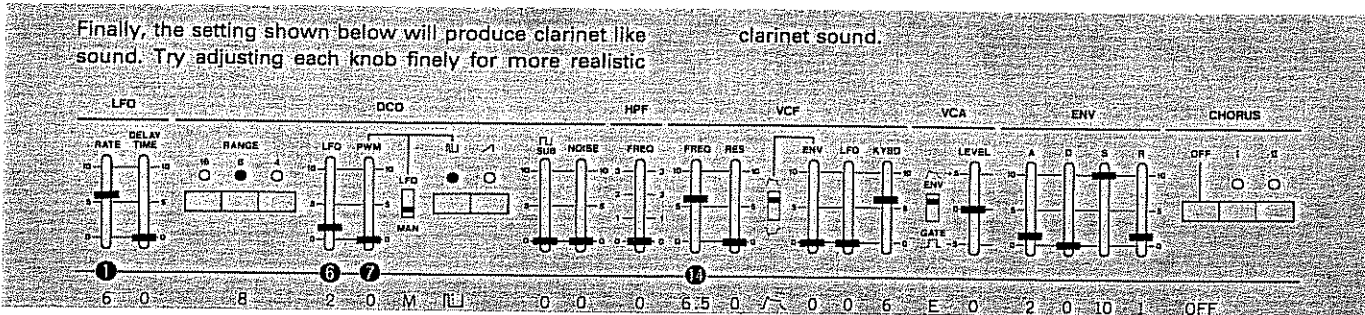

Push the buttons 9 and 10 alternately to change the waveforms. Then push the button 11. (★4)

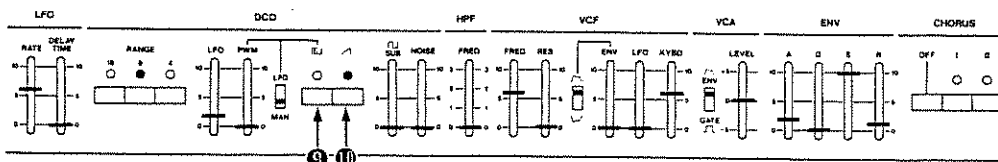

Set the knob 14 to the "8" position.

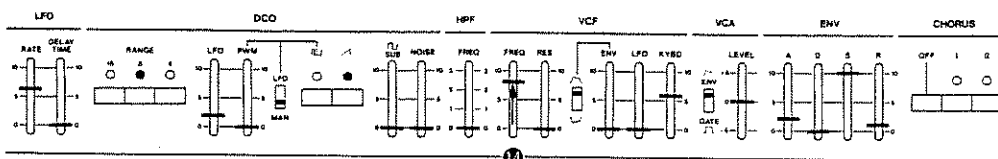

While playing the keyboard, try moving each knob of ② to ⑤ to grasp how it works. (★5)

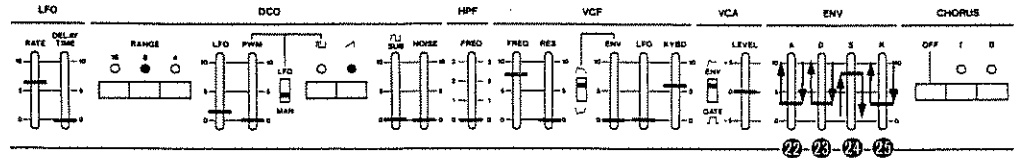

Set the knob ① to the "5.5" position.

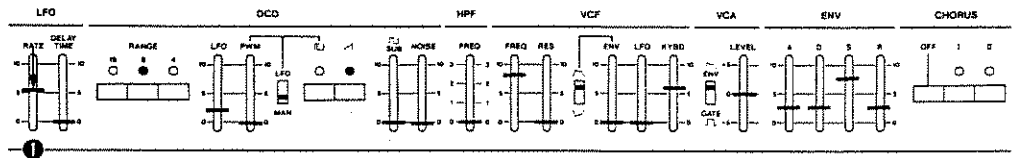

The knob ② can change the time needed for a sound to start vibrating. (★6)

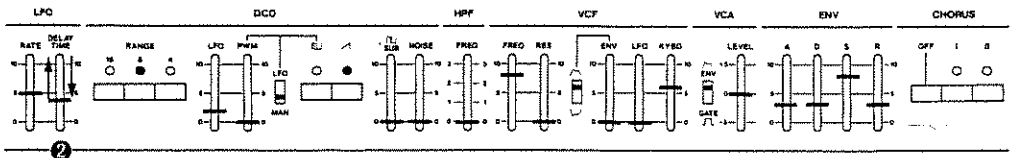

★ 1: In this section, a waveform, which is a basic element of a tone color, can be selected. The [] mark above the indicator shows the shape of the waveform (pulse wave). When this waveform is selected, moving the slider knob marked as PWM changes the width of the pulse wave therefore the tone color alters, too. When this knob is set to zero, the created waveform will be a square wave (□).

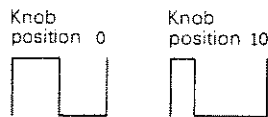

★ 2: Moving this knob also changes the tone color; making it softer or harder. That is, it cuts off higher harmonic contents and as it is set near zero, even the fundamental is cut off, no sound being heard.

★ 3: This is used to vibrate the sound. There are a few kinds of vibrations, but this is the one called vibrato effect which is caused by pitch alteration. The rate of the vibrato is adjusted with the knob located to its left.

★ 4: These buttons are used to select a waveform that is the basic element of synthesizing. Push the button to turn it on, and push it again to turn it off. When the button is on, the indicator lights up. You can turn both buttons on to mix these two waveforms, but here we select / which is called sawtooth wave.

★ 5: These four knobs are used to change the shape of the envelope curve that controls tone color or volume within one tone color. Here, the curve decides the volume alteration. (See ★10). The knob marked A determines Attack time that is the time required for the volume in a note to reach its maximum level. The knob marked D sets the decay time required for the volume to drop from the maximum to the sustain level. The S knob determines the sustain level which is the level sustained while the key is being pressed. The knob marked R sets the time needed for the level to reach zero after the key is released.

★ 6: This sets the time needed for a sound to start taking on the vibrato effect.

Now, violin like sound should be produced. It will become even more realistic by adding portamento effect explained

in the different book "Let's play the HS-60"

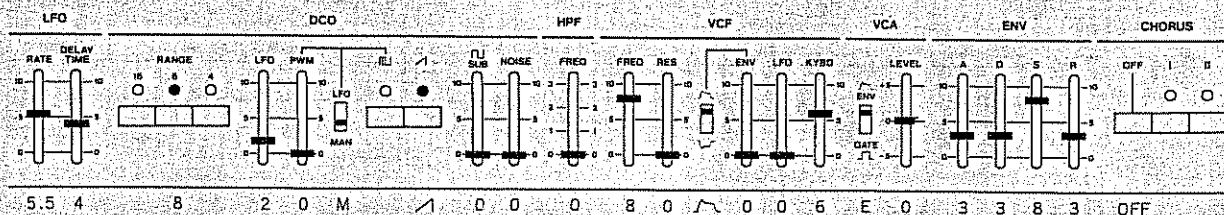

Push the button ③, ④ and ⑤ one after another, and the pitch of the keyboard will change in an octave steps. Here,

select button ⑥ and make sure the indicator above lights up. (★7)

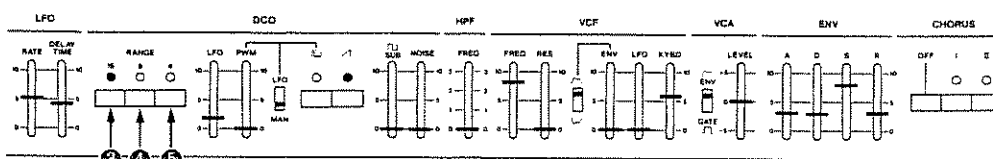

The knob ⑩ also serves to make the sound softer or harder. How this knob affects the sound, however, differs

depending which note you play. Try to see the difference by playing various keys. (★8)

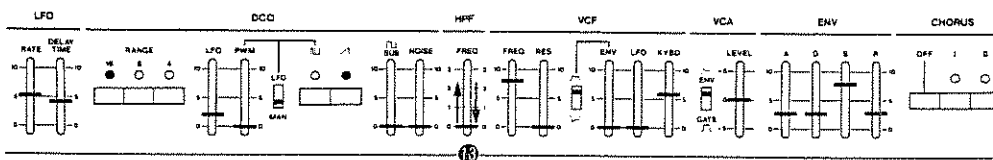

Set the knob ⑩ to "5".

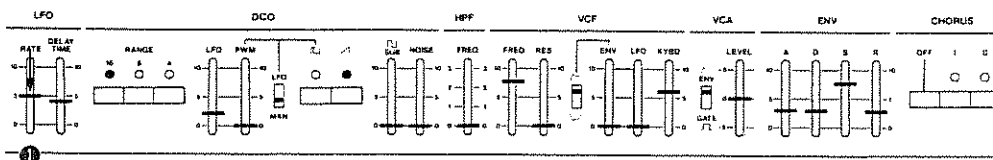

Set the knob ⑬ to 7.

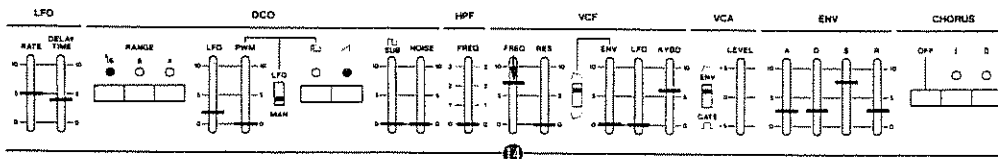

Now, the violin like sound has become cello. (★9)

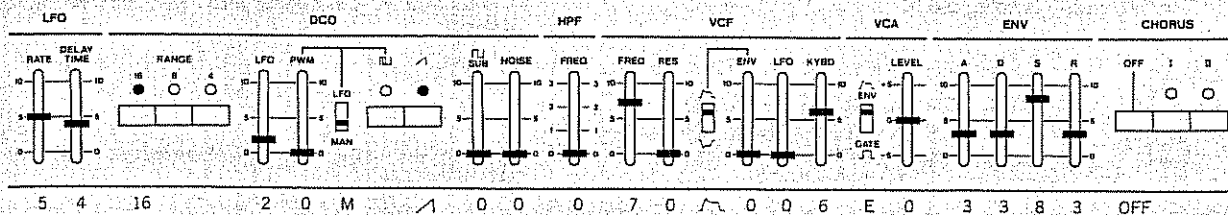

Push the button ④ to select 8' pitch.

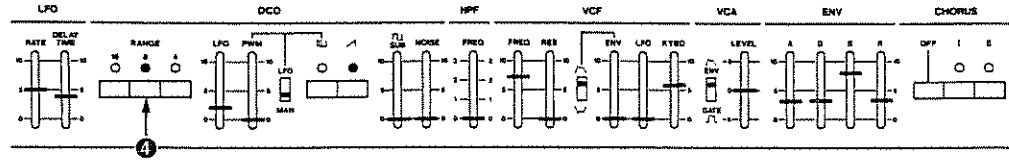

The depth of effect obtained by the knob ⑳ to ㉓ can be controlled by the knob ⑰. When the knob ⑰ is set to high

position, the knob ⑰ has little effect. Play the keyboard and move these two knobs to grasp their relation. (★10)

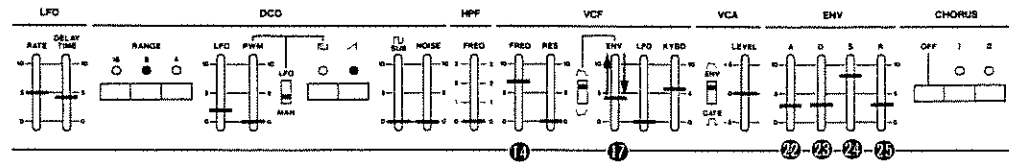

Set the knob ㉒ to 2, and ㉓ to 5.

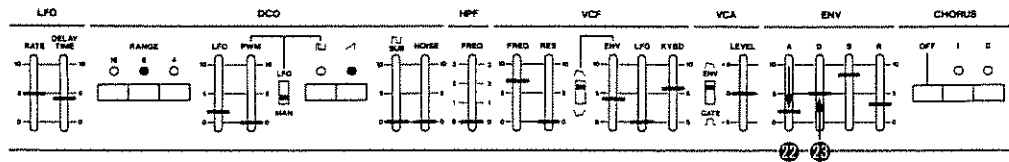

Set the knob ⑰ to 2.

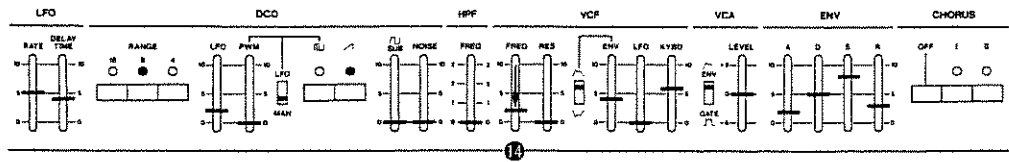

★ 7: By using these buttons, the pitch of the entire keyboard can be changed in an octave steps.

★ 9: The reason why we slows the speed of the vibrato here is that the quick vibrato is an extremely difficult technique for the cello. It is important to correctly extract the characteristics of the instrument you wish to simulate.

★ 8: When this knob is set to zero, lower frequencies are boosted, and as it is raised, they are cut off, making the lower sounds thinner.

★ 10: When this knob is set to around 5 to 7, the envelope curve set with the knobs ㉒ to ㉓ will control the tone color.

Set the knob 6 to zero.

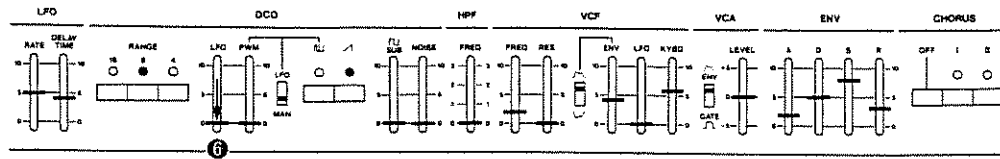

Raise the knob 18 slightly, and the sound will have a regular timbre change: between brighter to darker. (★11)

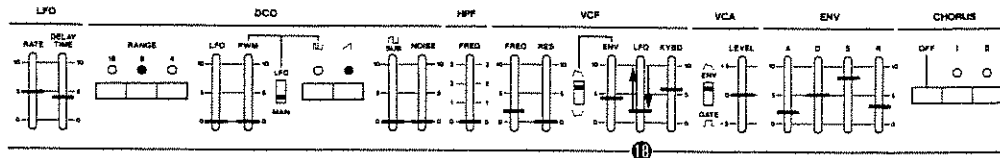

Set the knob 1 to "6".

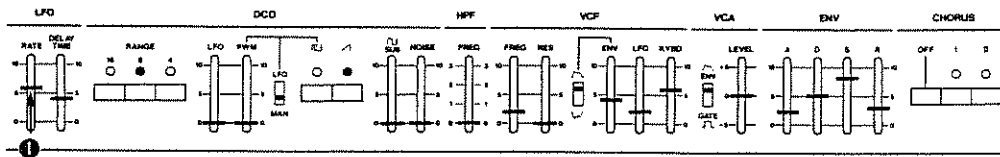

The knob 18 is provided to make more realistic sounds. When you are trying to produce a sound simulating to an existing musical instrument, this knob can be effectively used to make the higher note sound thinner and smaller, and the lower note sound fatter and louder, so that it will

sound to your ear more realistic. You may not be able to recognize the difference made by this knob, if not, use a soft sound, then play the highest and the lowest keys as you LOWER the knob. (★13)

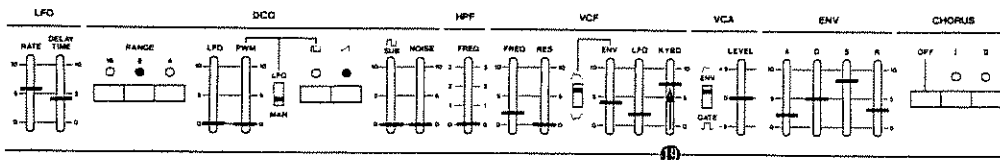

Now, the cello like sound has turned to flute.

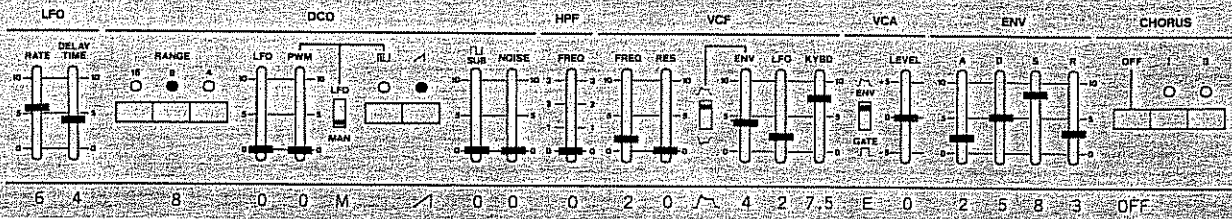

Set the knob 24 to "3.5", and the knob 25 to zero.

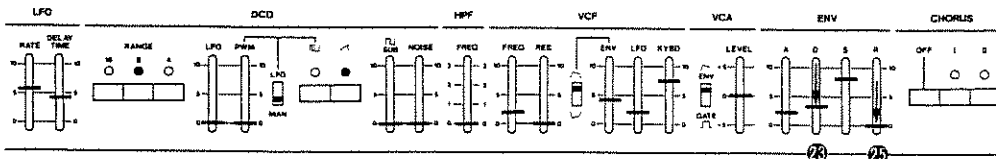

The knob 15 can be used to make a sort of electric, unusual sound. This knob works quite differently depending on the

position of the knob 14. Play the keyboard and try to grasp the relation between these two knobs. (★12)

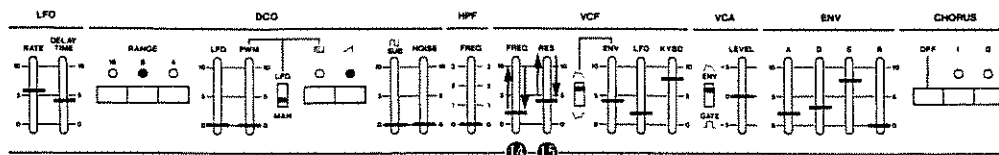

Set the knob 15 to "7".

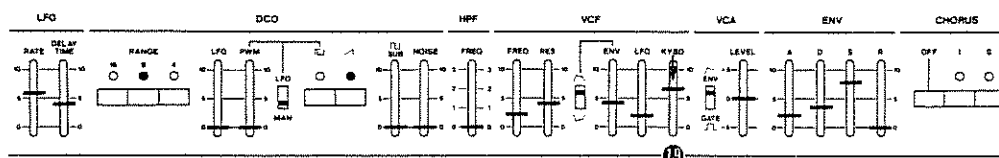

Set the switch 20 to the \square (GATE) position. (★14)

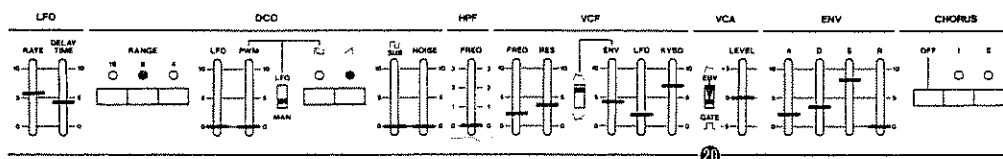

Set the knob 15 to "15".

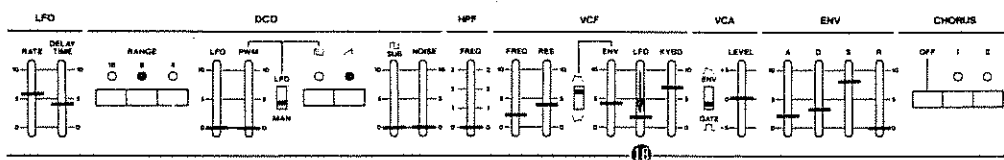

★11: You can create a type of vibration different from ★3. Just like the vibrato effect, the rate can be changed with the knob 1. This knob, however, will not work as much when the knob 13 is set too high.

★13: When this knob is set to "10", the lower and higher sounds will have exactly the same tone color. But it is not case for any existing acoustic musical instrument. So, it may be necessary to adjust the balance of the tone colors by LOWERING this knob.

★12: As this knob is raised, another sound source is produced and mixed with the existing sound. This is useful for making a kind of unusual sound. If you turn both sawtooth and pulse wave off, this will be the only sound you hear (see ★20). The waveform that this sound is made from is called sine wave.

★14: When this switch is set to \square (Gate), volume in a certain level will be output while keys are pressed, and the moment the key is released, the sound stops. That is, the four knobs 22 to 25 (envelope curve) have nothing to do with the volume alteration in a note, but can only control the tone color.

Now, the flute like sound has turned to a trumpet.

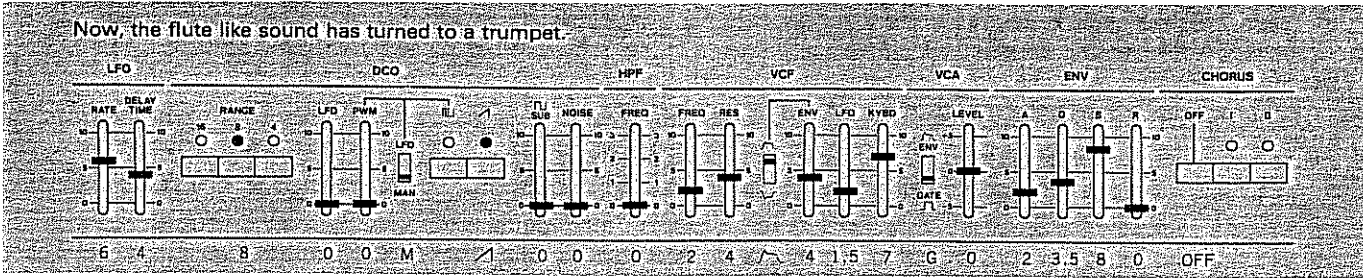

Set the knob 16 to "6".

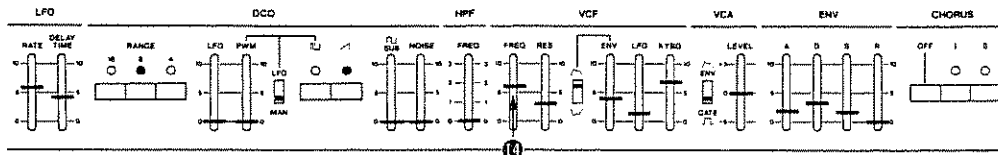

Set the knobs 22 and 24 to zero, and the knob 23 to "2.5".

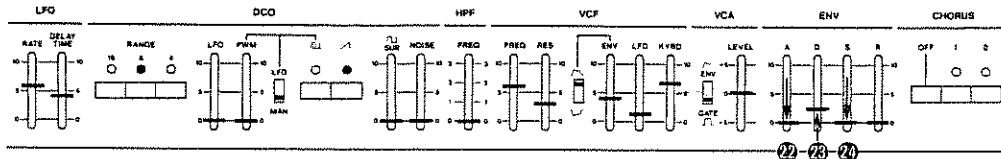

Change the switch 18 to the  position. (★ 15)

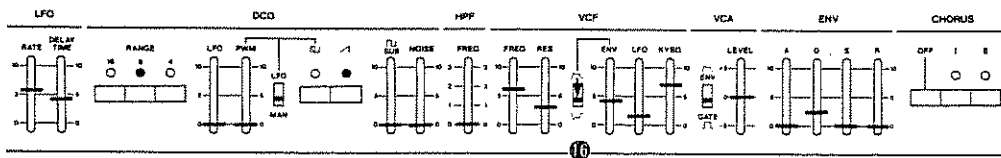

Set the knob 17 to "8".

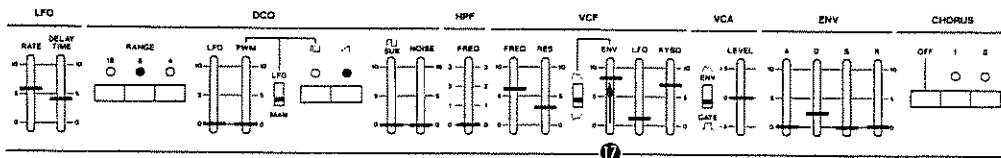

Now the completed setting is shown below. Change the position of the switch 18 and see the difference.

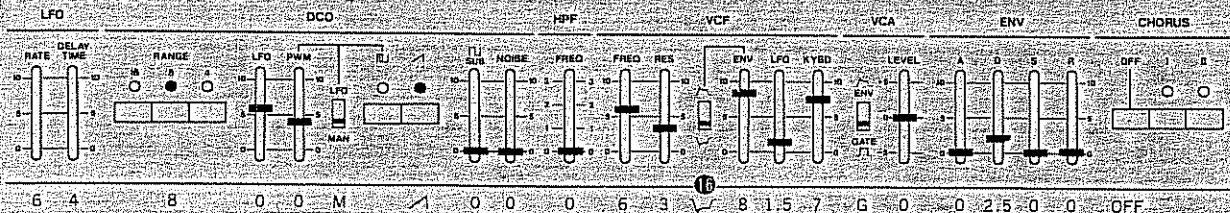

Set each knob, switch and button as shown below to return to the trumpet.

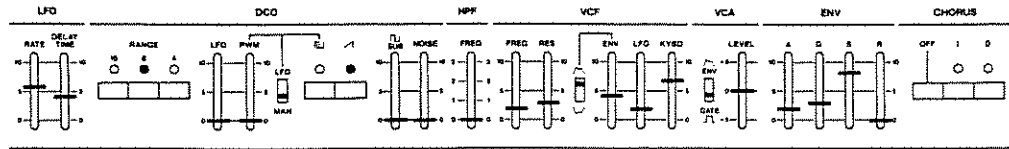

The knob 11 can be used to create a fat sound. Raising this knob even slightly will make a mixture of normal sound

and an octave lower. (★16)

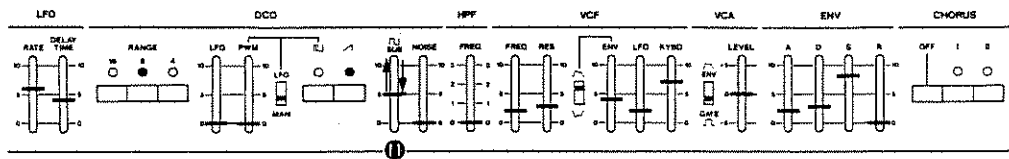

Push the button 9 to mix a square wave with the existing sawtooth wave.

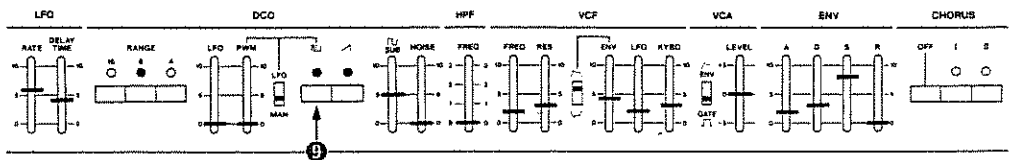

Set the knob 14 to "3.5".

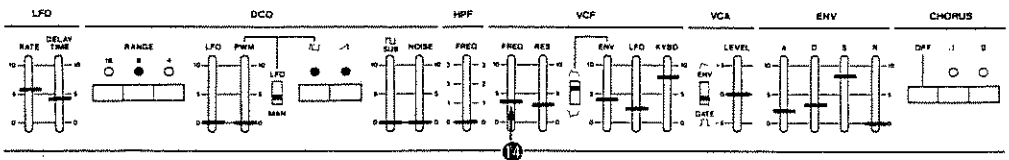

Push the both buttons 9 and 10 to turn them off (the indicators go out), set the knob 11 to zero, and raise the knob

12. Now, you will hear the sound just like the one heard from the TV after all the programs are finished. (★17)

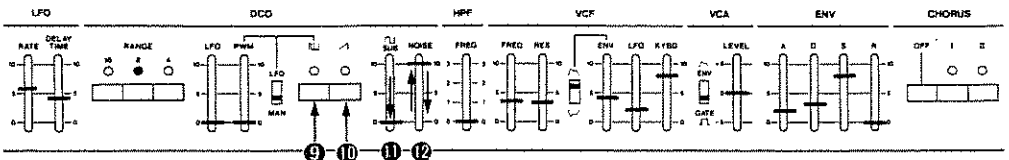

★15: When this switch is set to the \checkmark position, the envelope curve set with the knob 22 to 25 will affect the sound in exact opposite direction, giving an interesting effect.

★17: This is called Noise and can be effectively used for creating wind, surf and so on. With this set to zero, no noise is output, and as it is raised, more noise is output. Noise can be mixed with the sawtooth and pulse wave or on its own.

★16: Regardless of the setting of switches 3, 4 or 5, one octave lower than normal sound will be output. It may also be interesting to turn the switches 9 and 10 off, and set this knob to "10".

Set the knob 15 to zero.

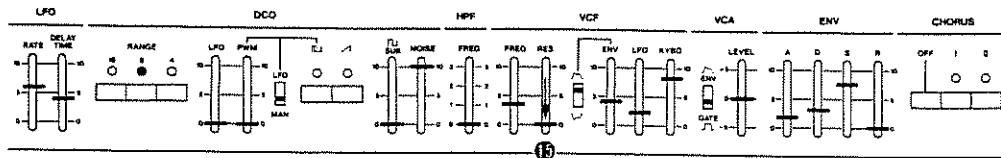

Set the knob 16 to zero.

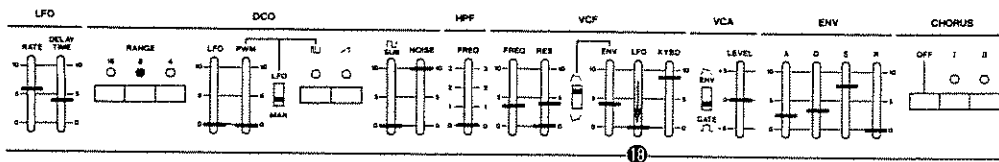

Set the knob 22 to "9", the knob 23 to "0", the knob 24 to "10" and the knob 25 to "8".

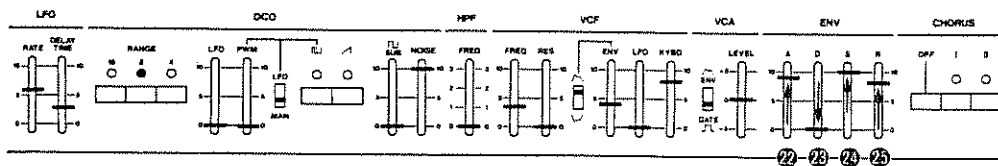

Change the switch 20 to the ENV (ENV) position.

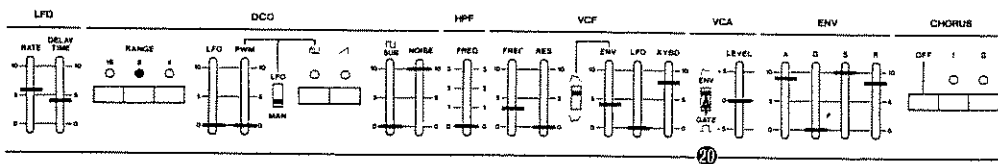

Set the knob 19 to "10".

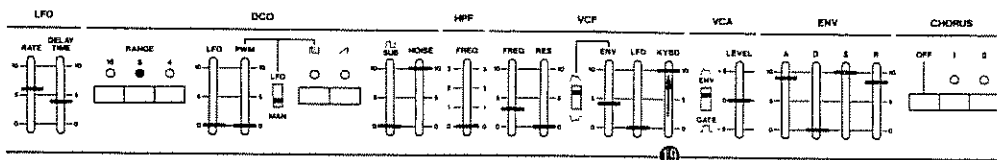

Now, try playing various keys, and surf like sound will be heard.

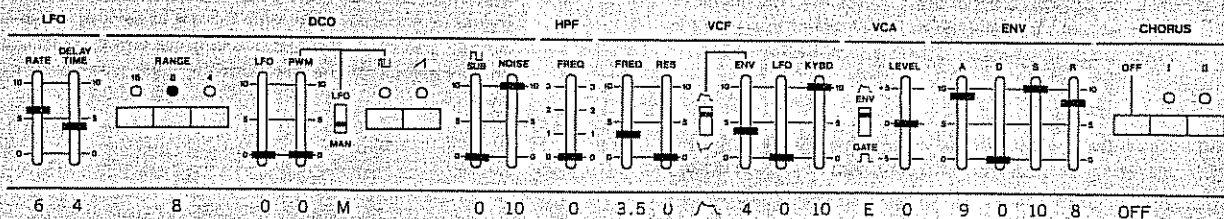

Set each knob, switch and button as shown below to make a clarinet sound.

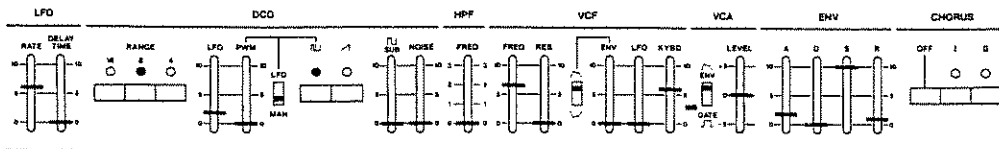

Set the knob 18 to "10".

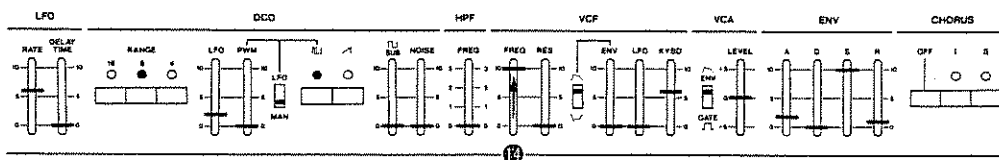

Change the switch 19 from the MAN to the LFO position. (★18)

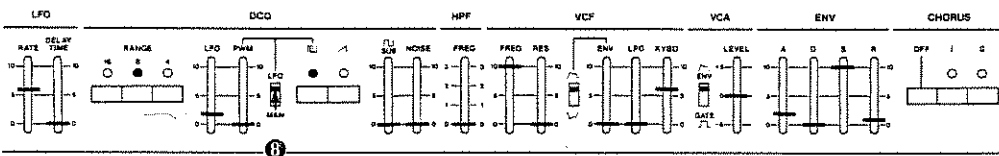

Now, you will notice the sound vibrating by raising the knob 7, but this is somewhat different from a usual vibrato

effect. The depth of the vibration changes with the position of the knob 7. Set it as shown below. (★19)

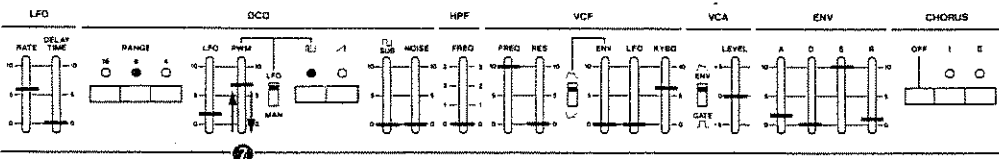

Set the knob 16 to zero.

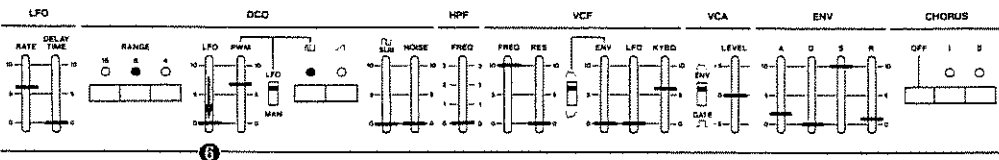

★18: This consists of a waveform that changes as shown below, and sounds as if it had two sound sources. And one of these will sound out of tune.

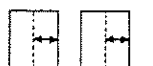

★19: When the switch 19 is set to MAN, moving this knob changes the shape of the pulse wave (see ★1). When the same switch is set to LFO, however, this knob changes the waveform. Raising this knob always increases the maximum effect of changing the waveform.

Move the knob 16, and the speed of the vibration will change.

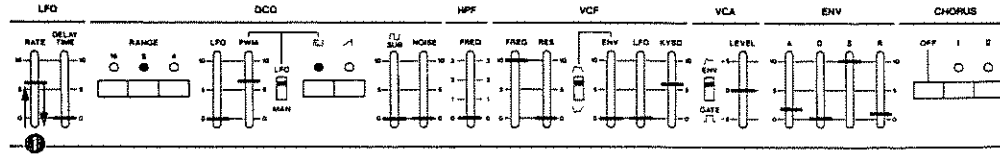

Set the knob 25 to zero.

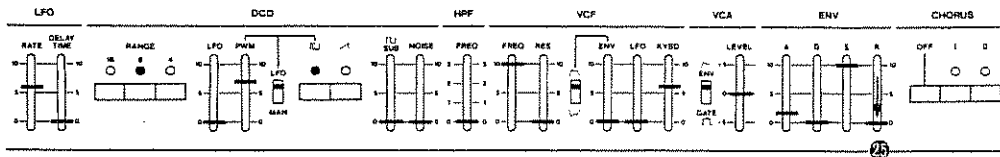

Now, you will hear the accordion like sound.

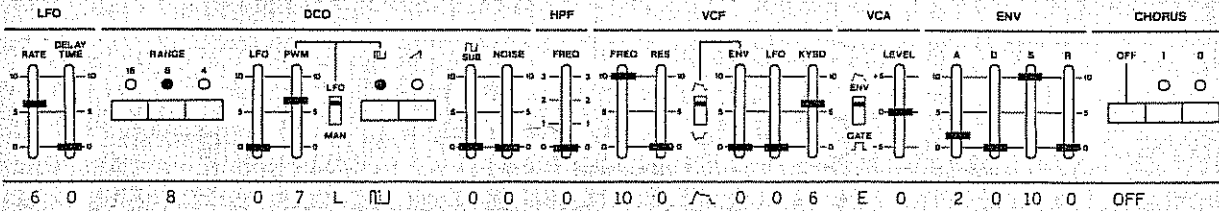

The following is the example setting for creating the beep explained in ★12. (★20)

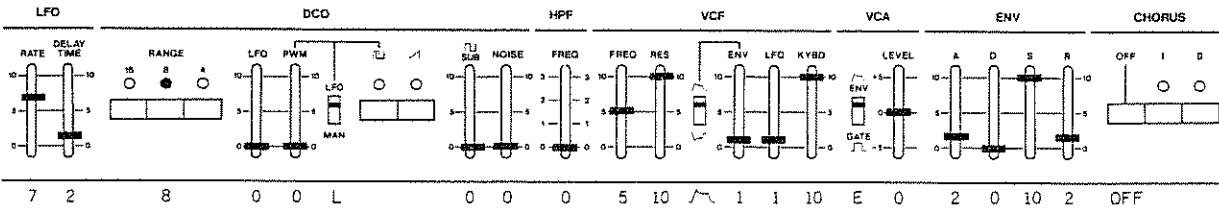

Set each switch, button and knob as shown below to make a violin like sound. Then, as you play the keyboard, push

the button 26, 27 and 28 one after another. (★21)

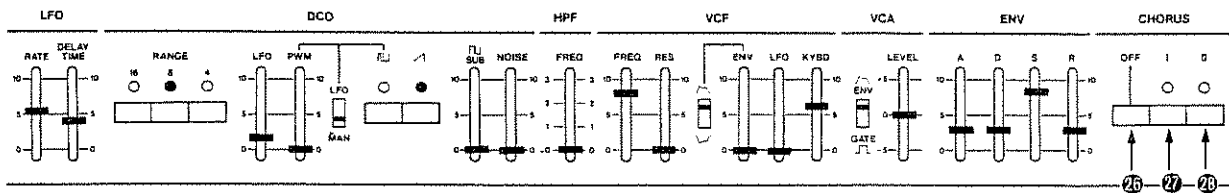

★20: The pitch of this whistle like sound can be changed with the knobs 16 and 17. Try moving the positions of the knobs.

★21: Turn the button 27 or 28 on, and the created sound will take on the chorus effect. "II" gives richer chorus effect than "I", and pushing the button 26 turns the chorus effect off.

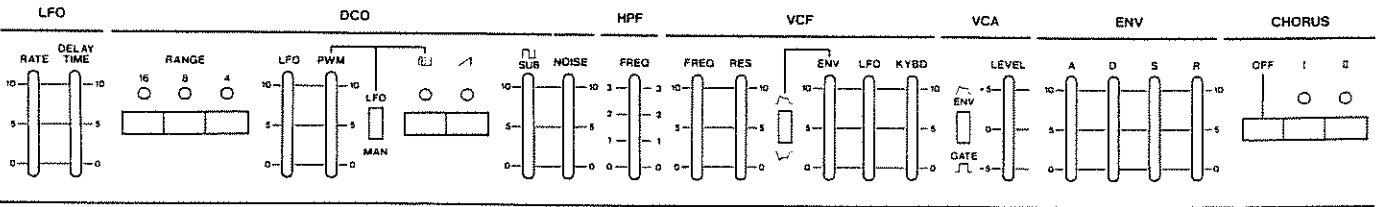
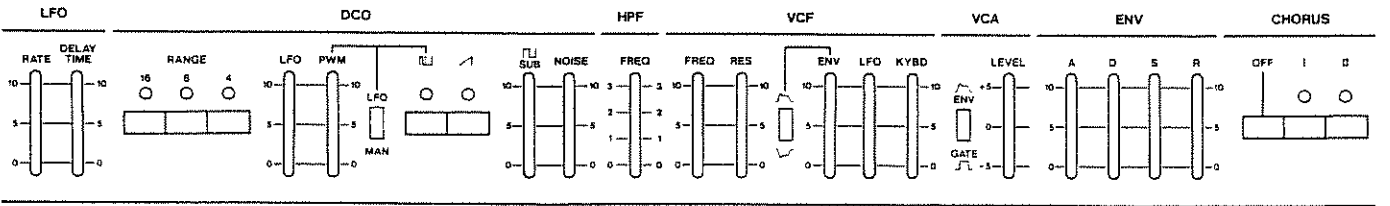
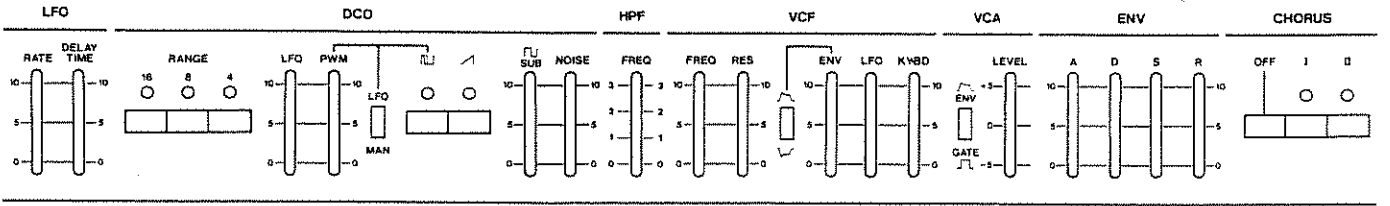
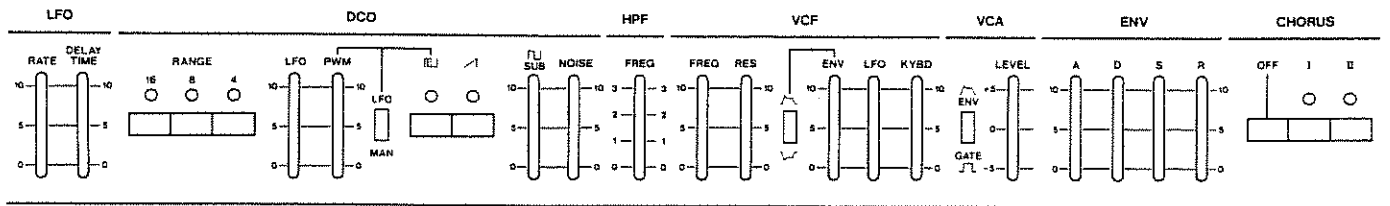
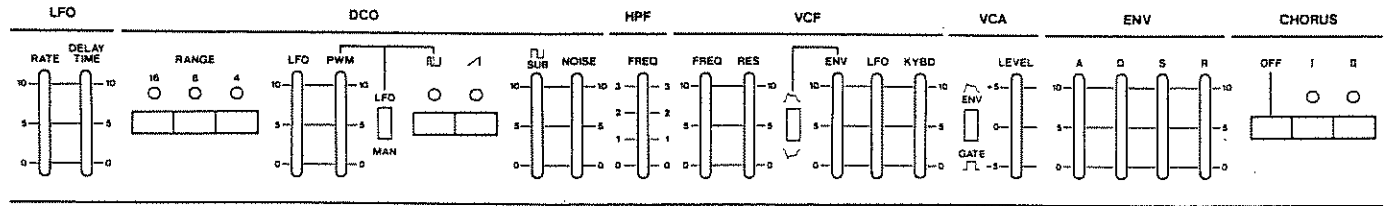

DCO (Digitally Controlled oscillator)

DCO is the Digitally Controlled Oscillator that controls the pitch and creates two types of waveforms which are the sound source of the synthesizer. Compared to VCO (Voltage Con-

trolled Oscillator), DCO has superior stability. The operations and functions of the DCO are virtually the same as those of the VCO.

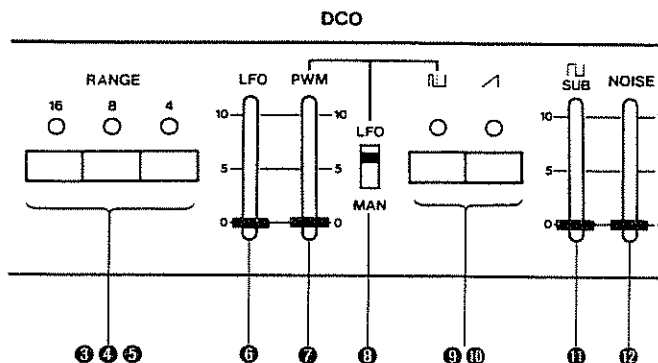

③④⑤ Range Selector Buttons

These select the pitch of the DCO. When 8' is selected, "do" (C) 3rd from the lowest falls on the Middle C of a piano keyboard. By using 4' or 16' position, one octave is shifted up or down, changing total range of the keyboard. (Refer to "Part 1" for the details)

⑥ LFO • Modulation Knob

It adjusts the depth of the vibrato effect when the LFO is controlling the pitch of the DCO.

⑦ PWM • Pulse Width Modulation Knob

When PWM Mode switch ⑧ is set to MAN, this knob controls the pulse width, and controls the intensity of the modulation when it is set to LFO.

⑧ PWM Mode Switch

When it is set to MAN, pulse width can be set to a certain ratio. When it is set to LFO, pulse width is controlled by the signal from the LFO.

⑨⑩ □ ▽ • WAVEFORMS

You can select the output waveform of the DCO. Each switch can be individually turned on or off and can be simultaneously used.

⑪ SUB • Sub Oscillator Level Knob

It controls the volume of the Sub Oscillator.

⑫ NOISE • NOISE Level Knob

It controls the volume of the NOISE.





<Pulse Width>

When the top and bottom portions of the square wave are unequal, the result is what is called a pulse wave. The harmonic content of the pulse wave will depend greatly on the width of the pulses. It is possible to modulate the pulse width by means of the LFO, or change by manual.

<Waveform>

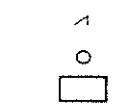
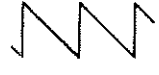
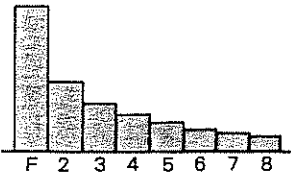
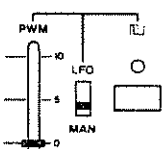
The DCO generates two kinds of waveforms (□ , ▽) which can be simultaneously used.

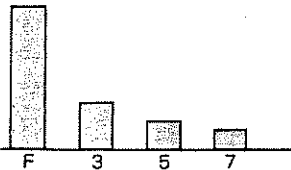
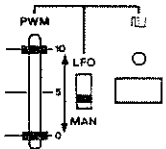
Waveform

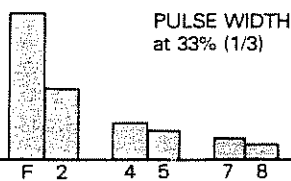
Setting	Waveform	Description	Harmonic Content
	 <p>Saw Tooth</p>	<p>The sawtooth wave contains a fundamental sine wave and its integral harmonic sine waves at a fixed ratio. The level of each harmonic is as shown on the right. When fundamental content is 1, the content of nth harmonic is $1/n$.</p>	
	 <p>Square</p>	<p>The square wave contains a fundamental sine wave and its odd numbered harmonics at a fixed ratio. The level of each harmonic is the same as sawtooth wave: the content of nth harmonic is $1/n$; except that there are no even numbered harmonics.</p>	
	 <p>Pulse</p>	<p>With pulse wave, the harmonic content greatly varies depending on the pulse width. It is characterized by a lack of the nth harmonic series when the pulse width is $1/n$. The example on the left lacks 3rd, 6th, and 9th harmonics because the pulse width is $1/3$ (33%).</p>	 <p>PULSE WIDTH at 33% (1/3)</p>

Pulse Width

► Manual PWM

PWM Mode Switch ⑧ → Set to MAN

Pulse Width Modulation Knob ⑦

→ Determines the Pulse width.

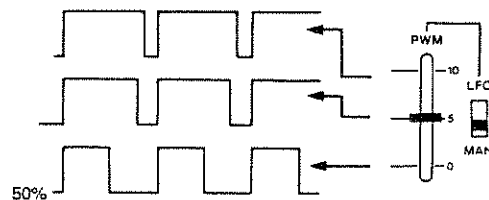

► PWM by LFO

PWM Mode Switch ⑧ → Set to LFO

Pulse Width Modulation Knob ⑦

→ Adjusts the intensity of the modulation.

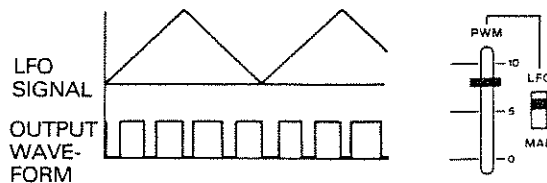

HPF

(High Pass Filter)

This filter lets the high frequency harmonics pass and cuts off the low frequency harmonics. As this filter is not voltage controlled, Cutoff Point is changed by only moving the knob.

16 HPF Cutoff Frequency Knob

This knob sets the Cutoff point of the HPF. With this set to 1, the DCO output passes the filter unprocessed, and as it is raised, Cutoff point is heightened, higher harmonics being passed. In the meantime, at its lowest position "0", lower frequencies are boosted. (This is specially useful for boosting bass sound of organ, etc.)

VCF

(Voltage Controlled Filter)

Each filter changes the tone color by cutting off or emphasizing harmonics. This filter lets the low frequency harmonics pass and cuts off the high frequency, and is controlled by a voltage.

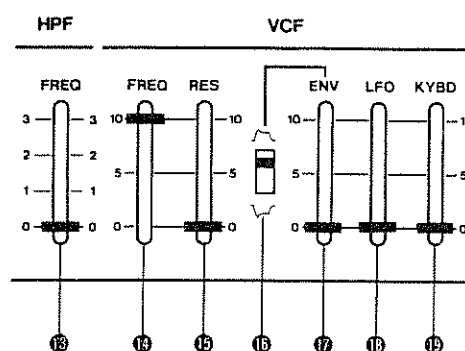
**16 FREQ • Cutoff Resonance Knob**

This knob changes the Cutoff Point of the VCF. As you lower the knob, higher frequency will be cut off and the waveform gradually becomes an approximation of a sine wave, then the sound will fade out.

17 RES • Resonance Knob

This control emphasizes the Cutoff Point set by Cutoff Frequency knob 16. As you raise the knob, certain harmonics are emphasized and the created sound will become more unusual, more electronic in nature. If you alter the Cutoff Frequency Knob while the Resonance Knob is set to a high level, you can create a type of sound that is attainable only from a synthesizer. If you raise the Resonance knob up to the maximum, the VCFs will start self oscillation.

18 ENV • Envelope Modulation Knob

When the Cutoff Point of the VCF is being modulated by the output of the Envelope Generator, this knob is used to adjust the intensity of the modulation. You can change the Cutoff Point of the VCF in each note with the ADSR pattern previously set. So the tone color within one note can be changed quite drastically.

19 Polarity Switch

This is the selector switch for the polarity of the Envelope. When it is set at reverse polarity, the ADSR pattern will be reversed and the tone color alteration will be the other way round.

20 LFO • LFO Modulation Knob

When the Cutoff Point of the VCF is being modulated by the output CV of the LFO, this knob adjusts the depth of the growl or wah effect.

21 KYBD • Key Follow Knob

When the Cutoff Point is being controlled by the KYBD-CV (Keyboard control voltage), this knob adjusts the level of the KYBD-CV. Higher position of this knob prevents any inconsistency in the harmonic contents caused by pitch alteration. Consequently this knob is usually set to the maximum on such a long keyboard, but can be set to your taste.

► NOTE

- * The self-oscillation of the VCF does not guarantee an accurate pitch. Therefore, you cannot expect a correct scale when playing the keyboard.
- * If using the VCF self-oscillation as a sound source, its pitch may turn out unstable, since the Cutoff frequency does not change continuously. In such a case, move the position of the FREQ Knob 16 until you get a stable pitch. (If you write it into memory once and recall it, the pitch will be stable)

Cutoff Frequency

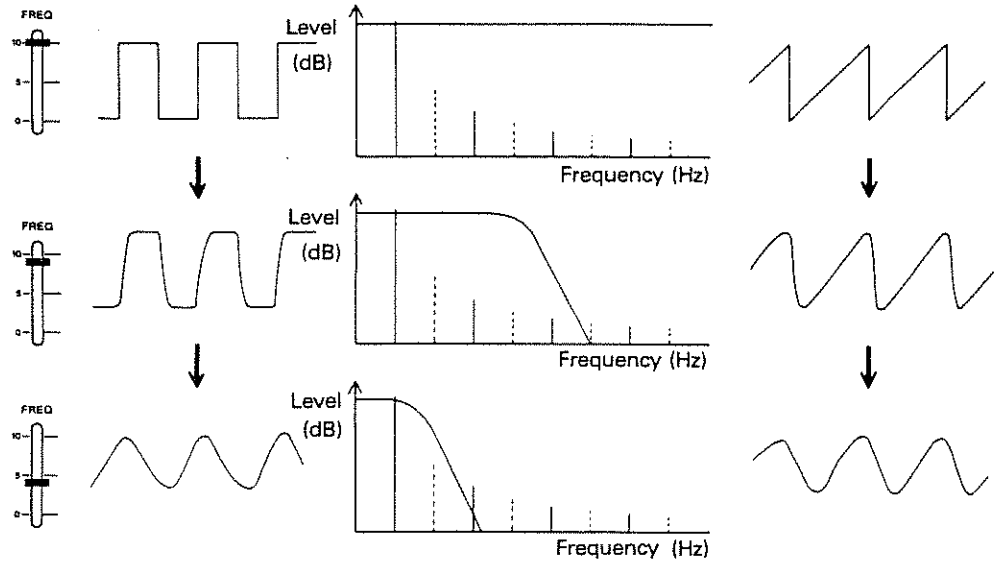

Resonance

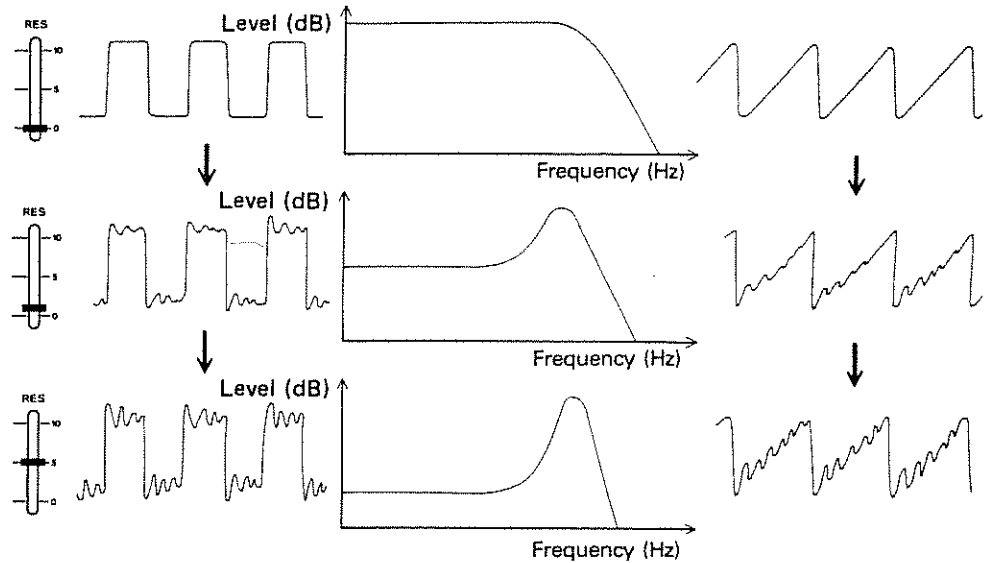

ENV Modulation

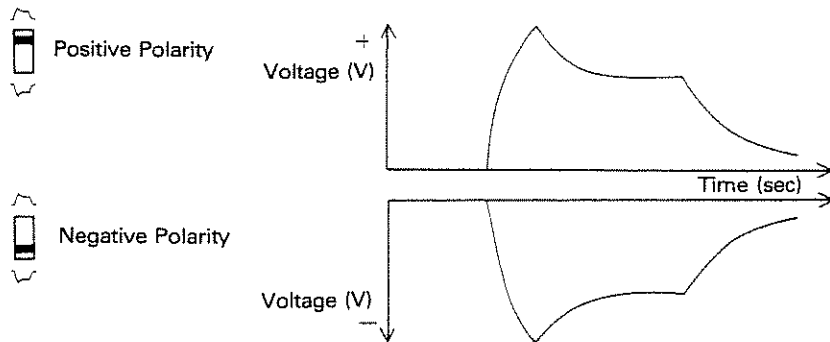

► **NOTE**

When modulating the VCFs' using the Envelopes, set the knob ⑩ to a fairly low level in case of positive porality, and set it to a fairly high level in case of negative. Otherwise there will be little effect of the envelope modulation.

VCA

(Voltage Controlled Amplifier)

This is to control the volume (amplitude) of the sound, and is normally controlled by the output voltage from the Envelope Generator.

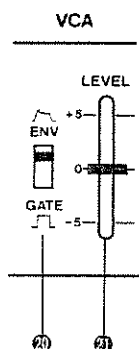

20 Control Signal Selector switch

This switch enables you to select whether to control the VCA by the signal from the Envelope Generator or by the Gate signal.

21 VCA Level Knob

This adjusts the volume level in the writing mode.

- * This knob can be used to match the amplitude (the volume sounds to your ears) of all the patch programs. This makes the live performance much more comfortable as there will be no volume difference realized between two different patches. While writing a patch into memory, adjust its level with this knob.
- * When this knob is set too high, a sound distortion might occur, but this is not because of the trouble of the HS-60.

ENV

(Envelope Generator)

This generates the Control Voltage applied to the VCF and the VCA, thereby controlling the volume and the tone color of each note. This output voltage is generated whenever you press a key.

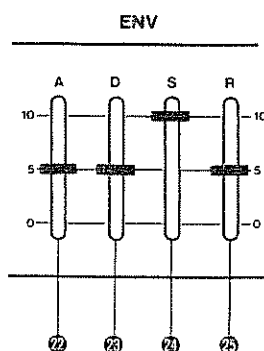

22 A (Attack Time) Knob

This sets the time required for the voltage to reach its maximum from the moment when the key is pressed down.

23 D (Decay Time) Knob

This determines the time required for the voltage to drop from the maximum to the sustain level. When the sustain level is high, the Envelope curve does not change by adjusting the Decay Time.

24 S (Sustain Level) Knob

This knob determines the Sustain Level to which the voltage falls at the end of the Decay Time.

25 R (Release Time) Knob

This sets the time needed for the voltage to reach zero.

■ ENV OUTPUT (ADSR)

■ KEYBD GATE

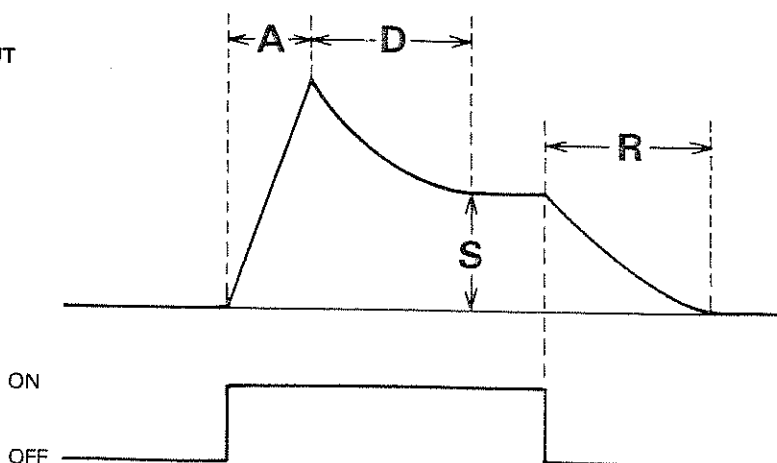

• The variation of ADSR

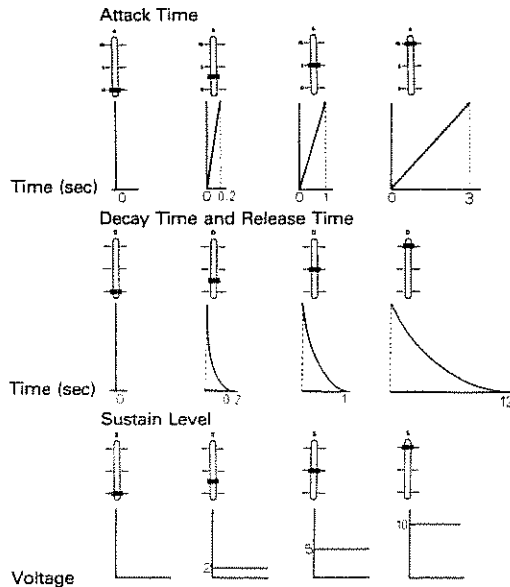

* In the figure shown above, the knob positions do not correspond with the exact time and voltages.

• Setting of ADSR and Envelope Curve.

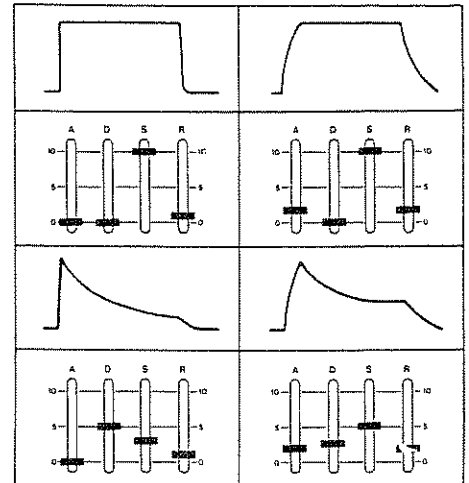

** When all of the ADSR sliders are set to zero, the envelope will be an extremely short Pulse wave, and only a short "click" is heard. Please be careful.

LFO
(Low Frequency Oscillator)

This oscillator generates only low frequency signal. It controls the DCO and the VCF to produce vibrato and growl effects.

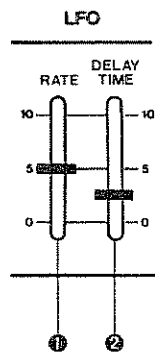

① **Rate Knob**
This sets the rate of the LFO.

② **Delay Time Knob**
This sets the time needed for the LFO to start to function.

The chorus effect gives spaciousness and richness to the sound. The effect becomes stronger from left to right, that is II is stronger than I. It is not possible to use I and II at the same time.

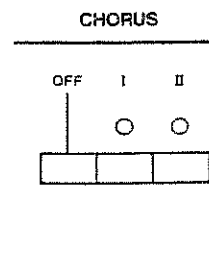

Memory

The HS-60 includes enough memory capacity to retain up to 128 different patch programs which you can change from one to another during live performance just by flick of a button.

Also, you can edit any patch program in use by moving the controls.

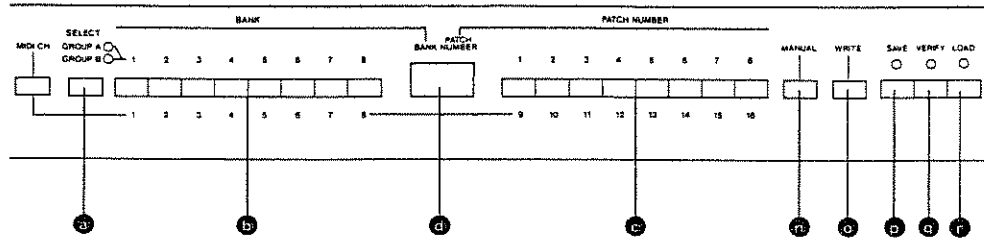

- a Bank Group Selector Button
- b Bank Number Buttons
- c Patch Number Buttons
- d Display Window
- e Manual Button
- f Write Button

The HS-60 features battery back-up system to retain the programs even when switched off. The battery should be replaced with a new one in every five years. In this case, please have your local Roland dealer replace the battery. (The first replacement might be required before five years.)

<Tape Interface>

- g Save Button
- h Verify Button
- i Load Button

(1) Editing

You can edit any patch program in use as you play. If you move a desired control even slightly, its setting position of that patch program will cancelled and ready to be manually controlled. As soon as you start editing, the two dots in the Display window will light, showing that the HS-60 is in Edit mode.

This Editing function may be used as a real time performance control since it does not automatically rewrite the existing program, unless the appropriate operation for rewriting is done. (Refer to P. 26 Therefore, selecting the same patch program later, you will hear the original tone color unchanged.

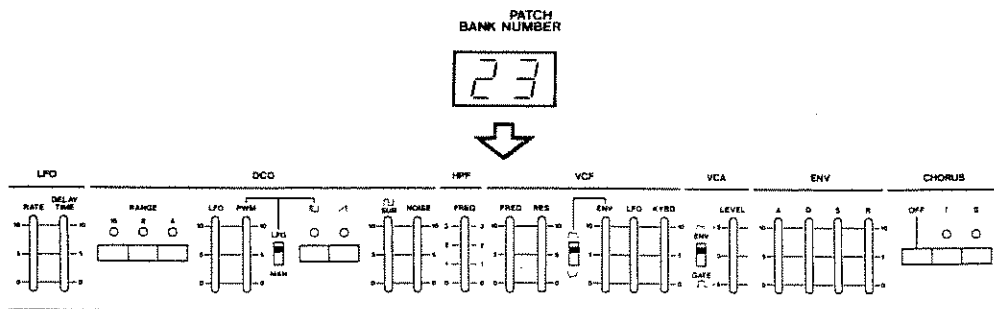

* Adjust the desired controls.

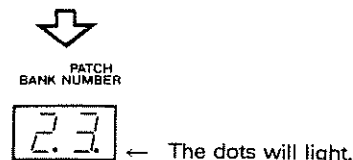

* Editing does not affect the original patch program.

(2) Writing

You can write a new patch or an edited program into memory. The parameters determined by controls under the red belt on the front panel is memorized as a patch program. (Refer to the diagram below).

* The patch program previously stored is automatically deleted when you have written a new patch.

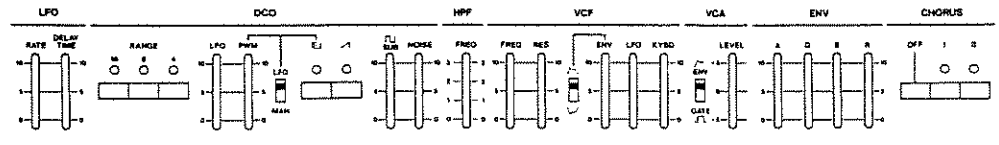

• **Memory Protect Switch**

Normally, set this switch to the ON position to protect the data from accidental loss. And set this to the OFF position when writ-

ing a patch program into memory, saving or loading.

(3) Writing

► **Operation**

1) Writing a new patch program

- ① Depress the Manual Button, then synthesize your own sound.
- ② Set the Memory Protect Switch on the rear panel to the OFF position.

- ③ While holding the Write Button down, press the Bank Number Button and the Patch Number Button. (Either of the buttons can be pressed first.)

- The Bank and the Patch numbers of the selected patch program is shown in the Display Window.
- Now, writing is completed.

- ④ Set the Memory Protect Switch to On.

► **Example 1**

Writing a new patch program into B-18.

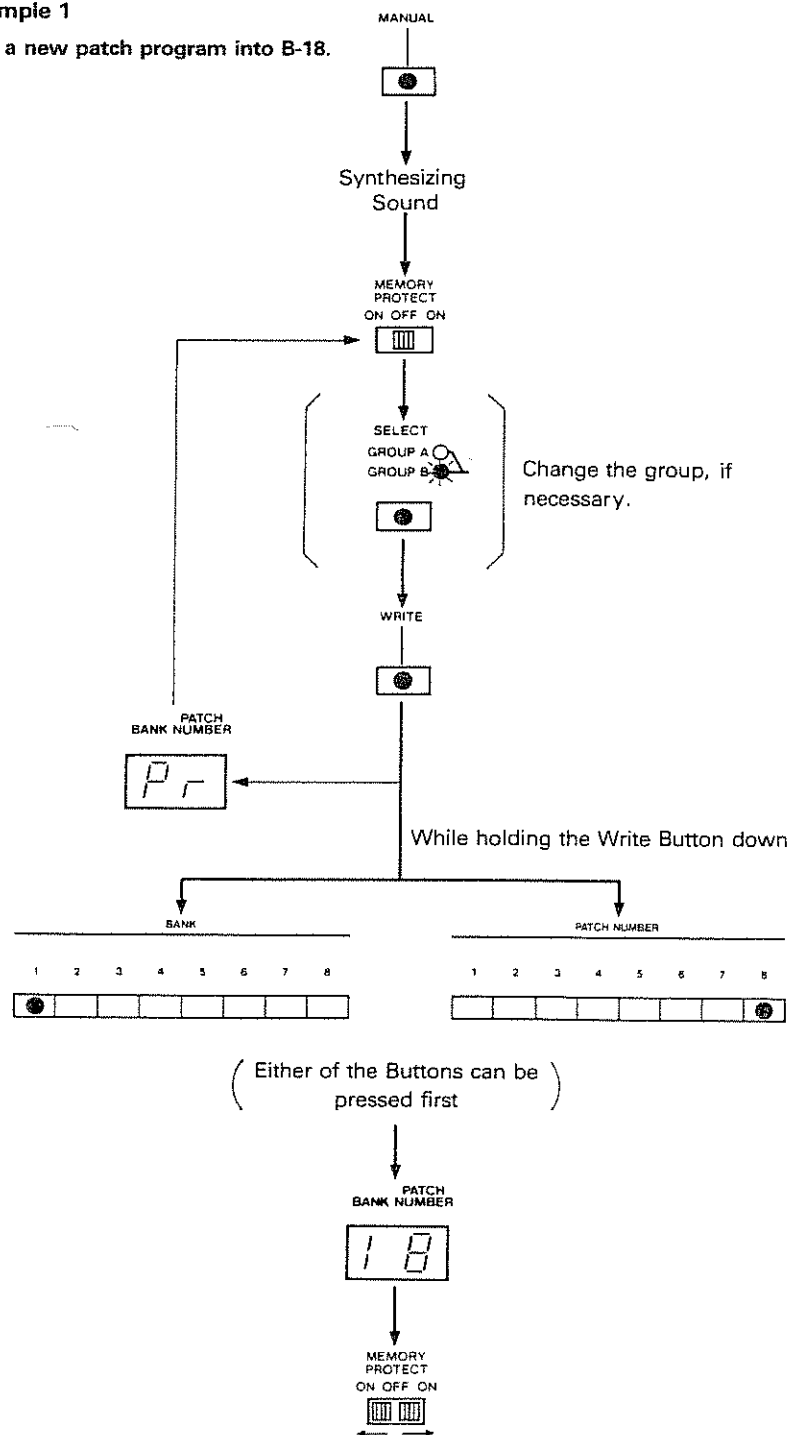

2) Writing an Edited Program

- ① Recall any Patch Program you like from memory, then edit it to your taste.
- ② Set the Memory Protect Switch on the rear panel to OFF.
- ③ If you wish to write the edited patch into the same Bank Group, do not touch the Bank Group Selector Button, but press the Bank and the Patch Number Button while holding the Write Button down. To write into a different Bank Group, while holding the Write Button down, initially press the Bank Group Selector Button, then the Bank and the Patch Number Buttons.
- ④ Set the Memory Protect Switch to ON.

► Example 2

Editing a patch A-13, then writing into A-88, or into B-23.

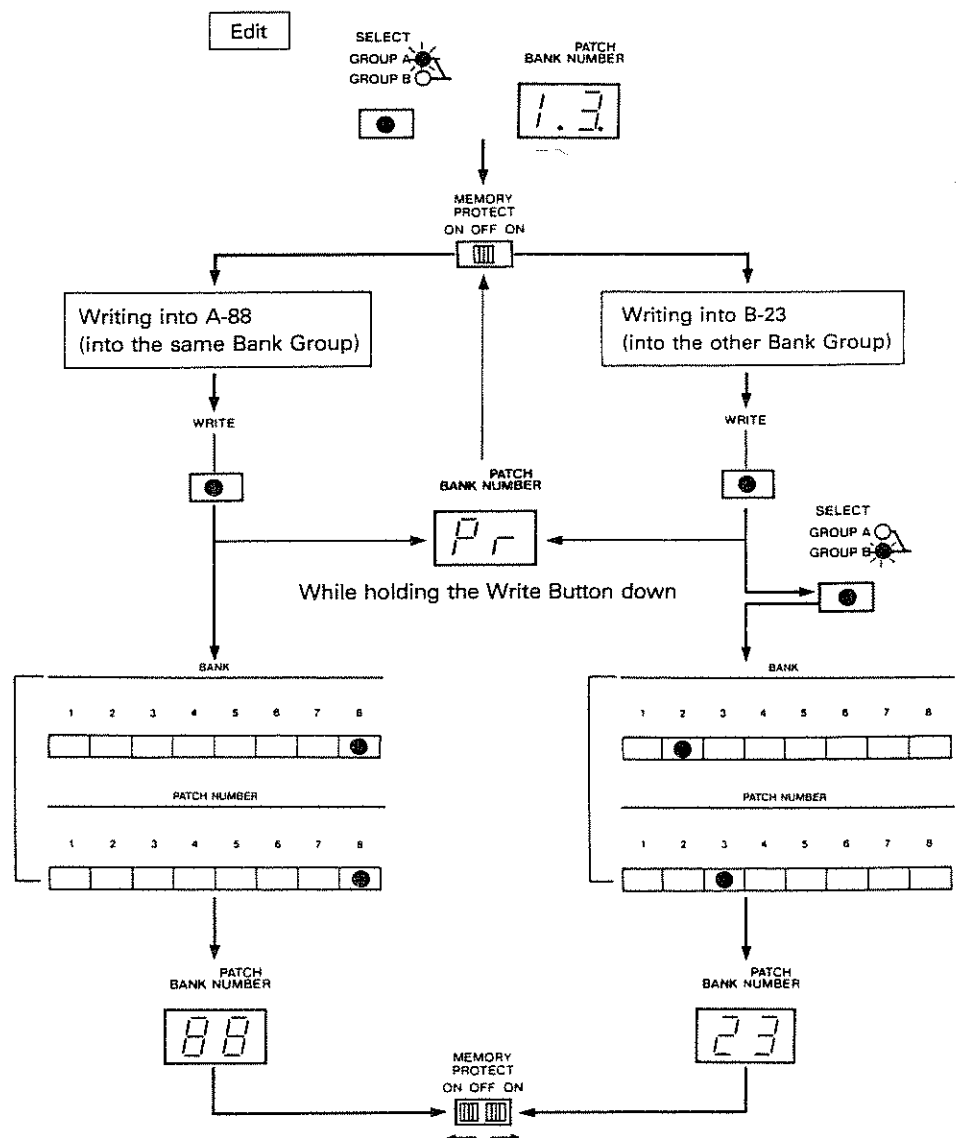

(4) Copy

This copy function allows you to copy any patch program and arrange the program numbers. There may be some patch programs which are more often used than others. If these patches are collected in the same bank, it will be easier to decide where to write a new patch, which after all save a great deal of work and time.

* This function is particularly useful when the Patch shift Function (Refer to "Part 1") is being used.

► Operation

- ① Set the Memory Protect Switch on the rear panel to OFF.
 - ② Assign the patch program to be copied by pressing the Bank Group Selector Button first, then the Bank Number and Patch Number Buttons. (The Bank and the Patch Numbers are shown in the Display.)
 - ③ If you want to copy the patch into the same Bank, press the relevant Bank Number and Patch Number Buttons, while holding the Write Button. To copy the patch program into the other Bank Group, it is required to assign the Bank Group. Hold the Write Button down and press the Bank Group Selector Button before pressing the Bank Number and Patch Number Buttons.
- The Bank and the Patch numbers are shown in the Display Window, and writing is completed.
- ④ Set the Memory Protect Switch to ON.

► Example

Copying a patch from A-18 to B-23

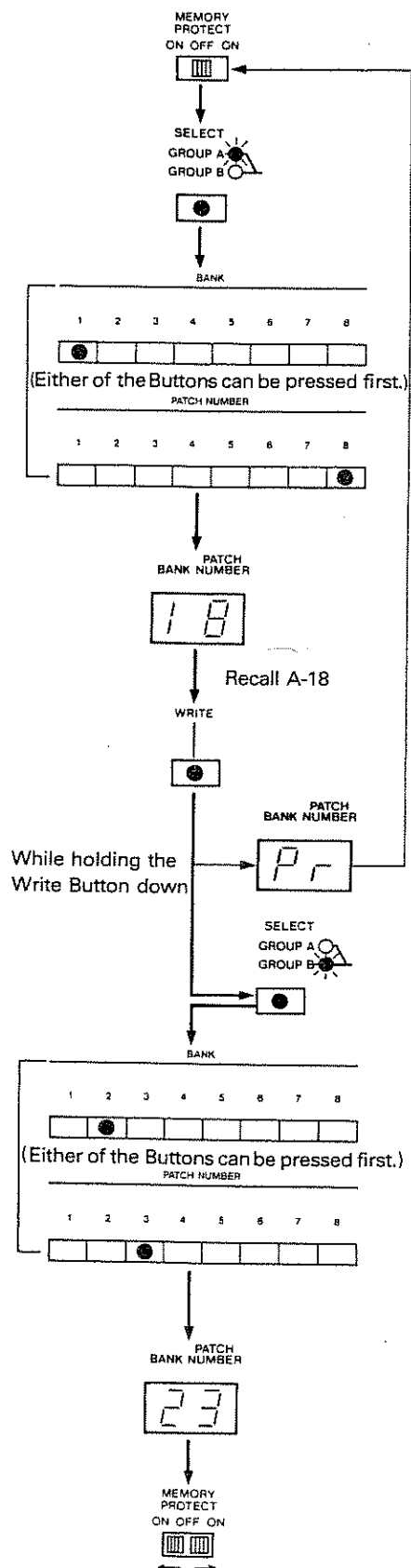

The HS-60 features the Tape Interface system which allows patch programs in its memory to be saved onto an ordinary tape recorder. The patch programs in the HS-60's

memory are fully supported by battery, but it may be a good idea to save them onto a tape sometime or other to prevent accidental loss of the data.

► **Connections**

▪ **SAVE**

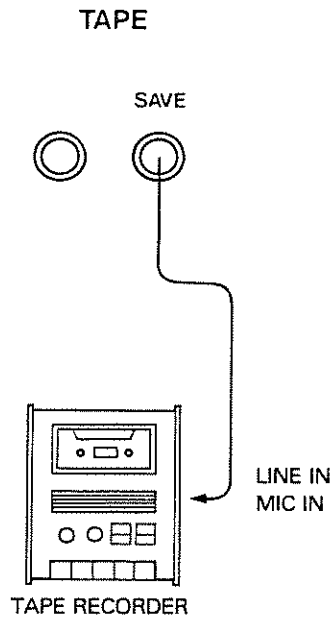

▪ **VERIFY, LOAD**

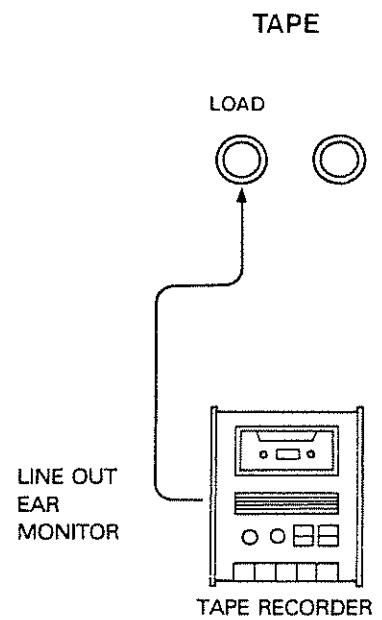

★ A whole Bank Group is saved, verified or loaded.

1. Save

► Operation

- ① Set the tape recorder to recording mode.
- ② Make sure the appropriate Bank Group Indicator is lighted (if Group A, the red one, and if Group B, the green one). If not, press the Bank Group Selector Button and change it.
- ③ Press the Save Button.

- The Save Indicator lights up and the indication in the Display Window goes out (Here, Pilot tone is output through the Save Jack).

- All patches in the Group will be saved.

- ④ If your tape recorder features a recording level control, set the level so that the Pilot tone will read around 0 VU.

- In about 4 to 5 seconds, the Pilot tone will turn to Modulated tone, and saving will start. (Please be sure to adjust the level while the Pilot tone is still heard.)

- * Press the Manual Button to stop saving in the middle.

- If the Save Indicator goes out and the Display shows "—", the saving is completed.

- * One action of Saving will save twice of the same data for reliability.

- ⑤ Stop the tape recorder.

- * It may be a good idea to verify every one of the data you have saved.

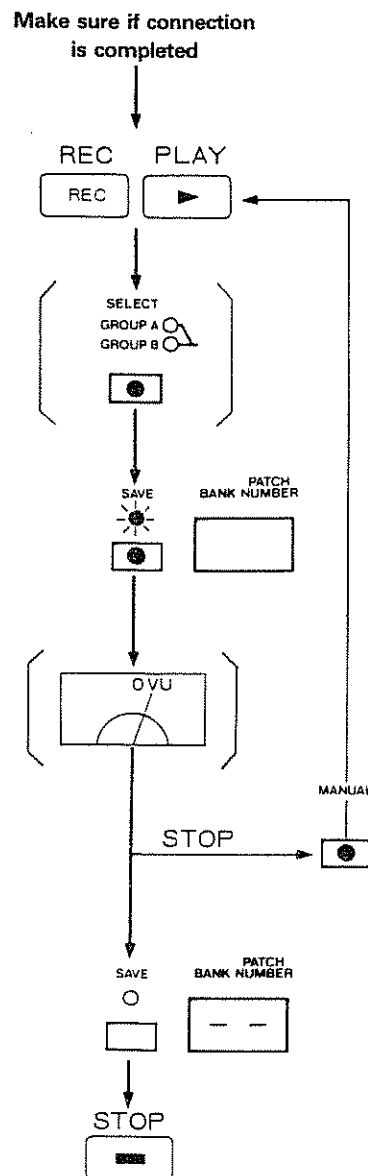

2. Verify

► Operation

- ① Set the tape so that the beginning of the data will start (where you hear Pilot tone).
 - * If your tape recorder features a playback level control, set it to medium volume.
- ② Assign the Bank Group A or B you wish to verify, by pressing the Bank Group Selector Button.
- ③ Set the tape recorder to playback mode, then press the Verify Button.
 - The Verify Indicator will light up and the Display will go dark. Then verify will begin.
 - If the Verify Indicator goes out and the display shows Manual indication " - - ", verify is completed.
 - * Press the Manual Button to stop verifying in the middle.
- ④ Stop the tape recorder.
 - * If there is any error, "Er" will be indicated in the Display Window. If so, carefully repeat the verify procedures. Also, try changing the volume and tone color of the tape recorder.
 - ★ If error is indicated again and again, refer to P.33.

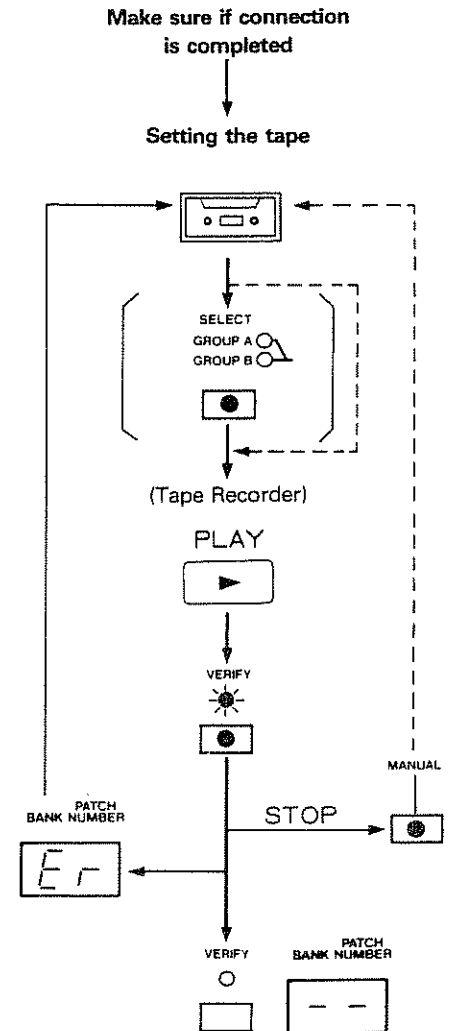

3. Load

▶ Operation

- ① Set the tape so that the data starts from the beginning (where you hear pilot tone).
 - ② Set the Protect Switch on the rear panel to OFF.
 - ③ Select either Bank Group A or B where you want to load the data, by pressing the Bank Group Selector Button.
 - ④ Set the tape recorder to playback mode and press the Load Button.
- The Load Indicator lights up and the indication in the Display Window will go out. And loading will start.
 - * Be sure to press the Load Button before the Pilot tone turns to Modulated tone.
 - * Press the Manual Button to stop loading in the middle.
- ⑤ When loading is completed, set the Memory Protect Switch to ON, and stop the tape recorder.
- * If error is indicated, carefully repeat Load procedure.
 - ★ If error is indicated again and again, refer to p. 33.

[Note]

In the HS-60, a whole Bank Group is saved, verified and loaded. It is possible to load the Bank Group A data saved on a tape into the Bank Group B in memory. The reverse way is also possible (Bank Group B → Bank Group A).

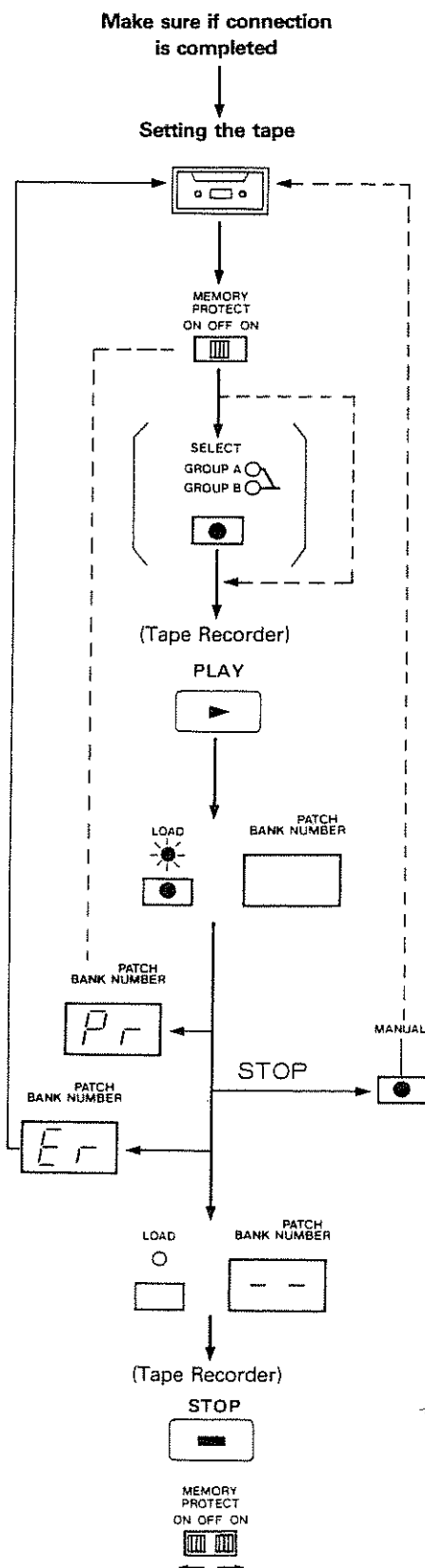

★ Important Notes on Operating the Tape Interface

If error is indicated in Verify or Load procedure of Tape Interface, carefully repeat each procedure taking care of the following points.

▶ When to press the Key

- Press the Verify or Load key while the Pilot tone is heard. Pressing the key while data is receiving (modulated tone heard) will cause an Error.

▶ Where to start recording

- Please do not start recording from the very head of the tape, but after slight lead-in.

▶ Connection

- Make sure that connections are made properly.
- If your tape recorder has two kinds of In/Out Jacks (i.e. MIC/LINE In, EAR/LINE Out, etc), try using different ones this time.
- Some tape recorders do not allow proper operation when both Save and Load connections are made at the same time. In such a case, make only the relevant connection.

▶ Tape you use

- Use a new and high quality tape, if possible. An old tape is liable to have drop-out, therefore likely to cause error more often.
- Use a cassette tape shorter than C-60. The one longer than C-90 is too thin for proper operation.

▶ Tape Recorder

- Try using the same tape recorder in Saving and Loading, so that possibility of error will be reduced.
- Clean and demagnetize the head of the tape recorder.

★ **If error is still indicated, use a different tape recorder.**

▶ Preserving Data Tape

Please do not keep the data recorded tape in extreme heat or humidity or near strongly magnetic units such as speaker or an amplifier. Also, be sure that the tape is completely rewound.

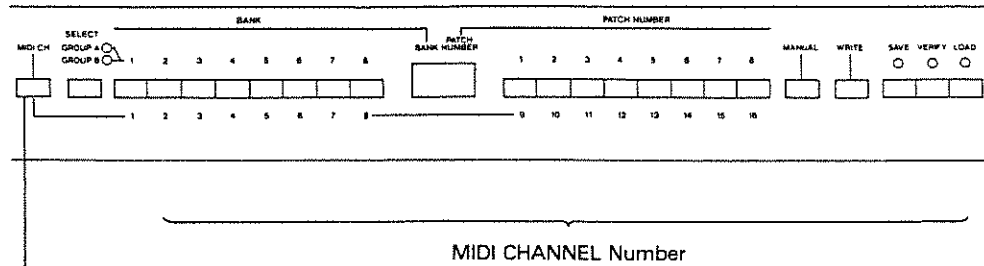

MIDI Channel Button

Pressing the MIDI Channel Button will cause the Display Window to show the MIDI Channel number currently set (1 to 16).

This button also includes the function of clearing information received from MIPI IN. If you are annoyed by a sound that would not stop at all, or Vibrato or Bender effect that remains against your will, press this button to stop it.

■ Changing MIDI Channels

While holding the MIDI Channel Button, press the Bank or Patch Number Button, and the new MIDI Channel number will be shown in the Display. Bank Buttons can be used for set-

ting MIDI Channels 1 to 8, and the Patch Number Buttons 1 to 8 correspond to MIDI Channel numbers 9 to 16.

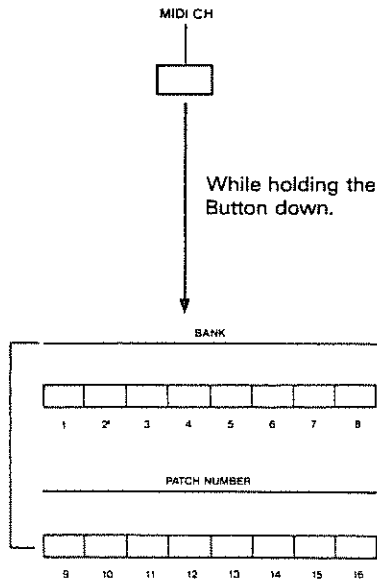

- Turning the HS-60 on will default to MIDI Channel 1, OMNI Mode OFF.
- * Please be sure no key on the keyboard is held down when pressing the MIDI Channel Button.

- * Both receive and transmit functions are included in the same MIDI Channel. For instance, changing the channel to "2" will turn both receive and transmit to Channel "2".
- * When the received MID information belonging to a channel which does not match the HS-60 MIDI channel, the MIDI information will be ignored (except when the HS-60 is in the OMNI ON mode).

► **MIDI Connectors**

Three jacks are provided to allow connection of the devices featuring the same system. (Connecting non-MIDI devices to the HS-60 will cause various troubles.)

MIDI IN Connector

By feeding digitally controlled signal of other MIDI device through this input jack, the HS-60 can be controlled externally.

MIDI OUT Connector

Through this digitally controlled signal is sent out from the HS-60 driving the MIDI device connected.

* In the HS-60, the signal received at MIDI IN will not be sent from the MIDI OUT.

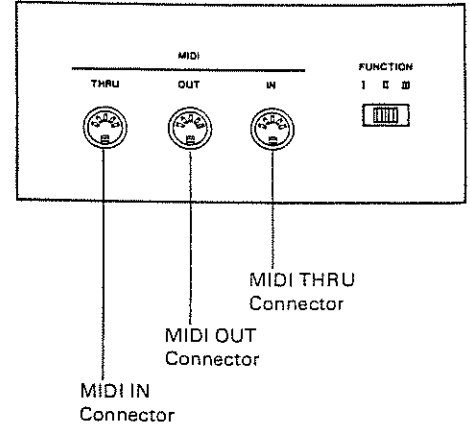

1) Parallel Setup with a Keyboard.

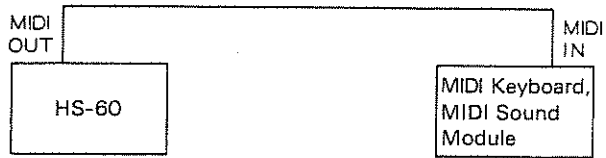

* In a parallel setup of the HS-60 and other keyboard, set the MIDI Function Switches to I or II.

2) Setup with a Keyboard Recorder

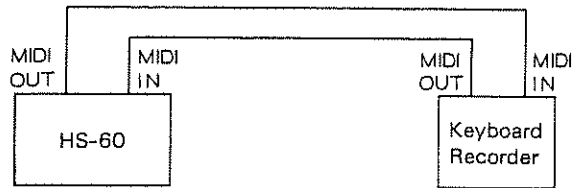

* If setting up the HS-60 with a keyboard recorder, set the MIDI Function Switch to I or II. Also, set the MIX OUT Switch on the back of the keyboard recorder to the OFF position.

③ **MIDI THRU**

The digitally controlled signal fed into the MIDI IN Connector will be output without processed from this MIDI THRU Connector. By using this Connector it is possible to control more than one device.

[Note]

Please do not set up more than 3 units at a time by using the MIDI THRU Connectors. Use the MIDI THRU Box MM-4 (optional).

e.g.) Simultaneous control over the ② and ③ by the HS-60 ①.

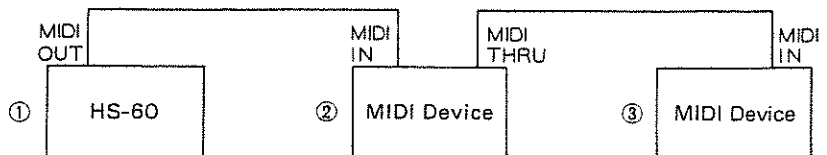

MIDI Function Selector Switch

► **MIDI BUS**

The MIDI Bus enables communications between two units (or more than two units) by means of digitally controlled signal. The information that can be communicated through the HS-60 MIDI Bus are as follows.

- 1) Keyboard
- 2) Hold (when a Pedal Switch is used)
- 3) Bender
- 4) Modulation by Bender
- 5) Patch Selections
- 6) Reception and transmission of tone color parameters by System Exclusive Message.

Depending on the position of the MIDI Function, the information to be communicated will differ (Refer to the table on the left).

FUNCTION

I II III



I KYBD
 II KYBD+BENDER
 +PGM CHANGE
 III ALL

Function Table

Function	I	II	III
Keyboard	○	○	○
Hold	○	○	○
Bender	×	○	○
Modulation	×	○	○
Program Change	×	○	△
System Exclusive	×	×	○

- ...Received and Transmitted
- △...Received only
- ×...Not received or Transmitted

[Note]

Program Change message "0" to "127" are assigned to the Patch programs of Group A-

11 to Group B-88.

Patch		Bank							
		1	2	3	4	5	6	7	8
A	1	0	1	2	3	4	5	6	7
	2	8	9	10	11	12	13	14	15
	3	16	17	18	19	20	21	22	23
	4	24	25	26	27	28	29	30	31
	5	32	33	34	35	36	37	38	39
	6	40	41	42	43	44	45	46	47
	7	48	49	50	51	52	53	54	55
	8	56	57	58	59	60	61	62	63
B	1	64	65	66	67	68	69	70	71
	2	72	73	74	75	76	77	78	79
	3	80	81	82	83	84	85	86	87
	4	88	89	90	91	92	93	94	95
	5	96	97	98	99	100	101	102	103
	6	104	105	106	107	108	109	110	111
	7	112	113	114	115	116	117	118	119
	8	120	121	122	123	124	125	126	127

[Note 5] MIDI Function (Application of System Exclusive Communication)

In parallel setup of two HS-60's, or the HS-60 and Juno-106, if the MIDI Function Switch is set to III, the master HS-60 can perfectly control the slave one. That is, Information of each parameter of the patch selected in the master HS-60 will be sent to the slave HS-60 by means of Exclusive Message. The Information here includes the setting of each control and switch. Here, the Patch Program number Information is not transmitted to the slave HS-60, but its tone color will turn out exactly the same as the master HS-60's, because of the parameter Information sent from the master HS-60.

Changing patches in the master HS-60 does not alter the Program Number currently shown in the Display on the slave HS-60, only dots will light indicating that Exclusive Message has been received.

- * Even if the slave HS-60 is set to Manual mode, dots lighting is seen in the display when the Exclusive message is received. Also if any of the controls or switches under a red belt of the master HS-60 is moved even slightly, corresponding parameter Information is transmitted to the slave HS-60, by means of Exclusive Message, therefore the slave HS-60 is perfectly controlled by it, regardless of its own panel setting.

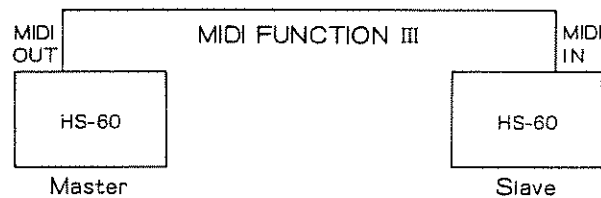

- Exclusive Message is a special kind of message that allows information to be communicated between two (or more) HS-60's, between the HS-60 and Juno-106, or between the HS-60 and a computer. This Exclusive Message is available only when the MIDI Function Switch is set to III. In the setup with a keyboard other than the HS-60 or a keyboard recorder, set the MIDI Function to I or II which does not allow communication by Exclusive Message.

Sound Range

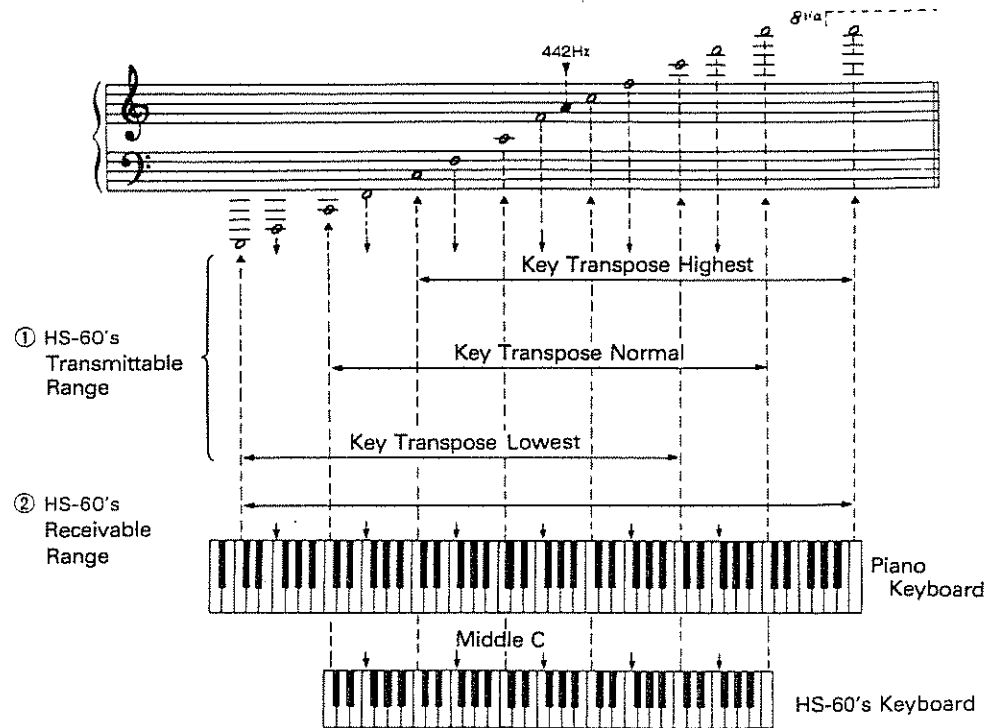

(1) The HS-60 features Key Transpose function that allows the entire keyboard to be shifted one octave up or down. ① in above picture shows the sound range of key information that can be transmitted by means of MIDI.

(2) ② in above picture shows the sound range (7 octaves) of Key Information that can be received by the HS-60. If the data sent exceeds this range, it will be automatically transposed up or down to fit in the range. Also, the key Transpose function does not work on the information sent through the MIDI IN.

Group()

Patch Bank	1	2	3	4	5	6	7	8
1	11	12	13	14	15	16	17	18
2	21	22	23	24	25	26	27	28
3	31	32	33	34	35	36	37	38
4	41	42	43	44	45	46	47	48
5	51	52	53	54	55	56	57	58
6	61	62	63	64	65	66	67	68
7	71	72	73	74	75	76	77	78
8	81	82	83	84	85	86	87	88

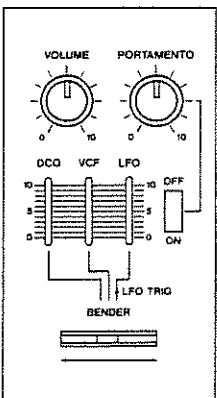
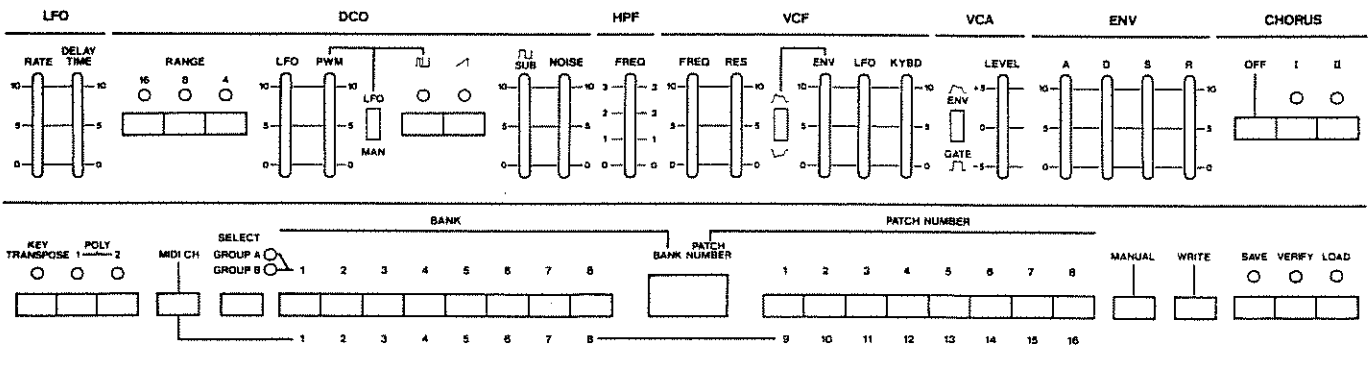
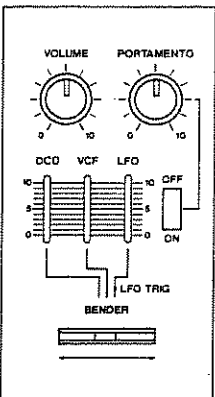
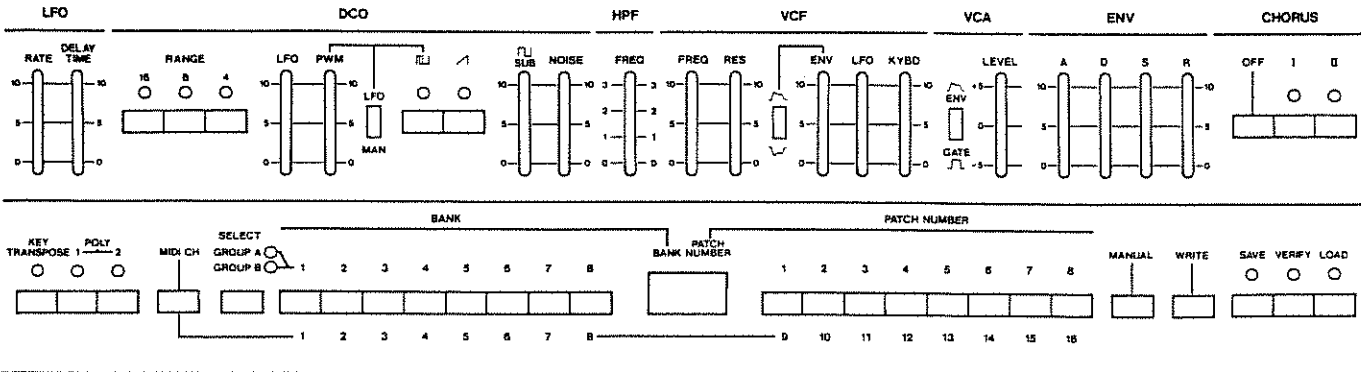

MODEL HS-60 MIDI Implementation Chart

Function.....		Transmitted			Recognized			Remarks
		1	2	3	1	2	3	
Basic Channel	Default Changed	1 1-16			1 1-16			Tx=Rx
Mode	Default Messages Altered	3 OMNI OFF, POLY *****			1 OMNI ON, /OFF, POLY MONO (M<>1) → 1,			(M=1) → 3
Note Number	: True voice	24-108 *****			0-127 24-108			The Note Number message that gives less than 5ms from Note ON to Note OFF cannot be received.
Velocity	Note ON Note OFF	× 9n v=64 fixed × 9n v=0			× ×			n= 0 - \$F
After Touch	Key's Ch's	× × × × × ×			× × × × × ×			
Pitch Bender		× ○ ○			× ○ ○			
Control Change	1 64	× ○ ○ ○ ○ ○			× ○ ○ ○ ○ ○			Modulation Hold Modulation value is 0 or 127
Prog Change	True #	× ○ × *****			× ○ ○ 0-127			0-127
System Exclusive		× × ○			× × ○			Tone parameters
System Common	Song Pos Song Sel Tune	× × ×			× × ×			
System Real Time	Clock Commands	× ×			× ×			
Aux Messages	Local ON/OFF All Notes OFF Active Sense Reset	× ○ (123) × ×			× ○ (123-127) × ×			
Notes	When power up, OMNI OFF, POLY ON are sent in channel 1.							

Mode 1 : OMNI ON, POLY
Mode 3 : OMNI OFF, POLY

Mode 2 : OMNI ON, MONO
Mode 4 : OMNI OFF, MONO

○ : Yes
× : No

6-voice synthesizer

MODEL HS-60 MIDI Implementation

1. TRANSMITTED DATA

1.1 When MIDI FUNCTION is 1.

Note events, Hold on/off and Channel Mode messages are sent.

Status	Second	Third	Description
1001 nnnn	0kkk kkkk	0100 0000	Note on
1001 nnnn	0kkk kkkk	0	Note off
1011 nnnn	0100 0000	0111 1111	Hold on from rear panel jack
1011 nnnn	0100 0000	0	Hold off
1011 nnnn	0111 1011	0	ALL NOTES OFF *2
1011 nnnn	0111 1100	0	OMNI OFF *1
1011 nnnn	0111 1111	0	POLY ON *1

Notes:

nnnn : MIDI channel number - 1. (if ch-1, nnnn = 0000)
 kkkkkk : 24 - 108
 *1 When power up or MIDI channel number is set.
 *2 When all Notes turn Off.

1.2 When MIDI FUNCTION is 2.

Messages in FUNCTION 1, Program Change, Bender and LFO Modulation are sent.

Status	Second	Third	Description
1100 nnnn	0ppp pppp		Program Change Group-A : 0 - 63 Group-B : 64 - 127
1110 nnnn	0bb0 0000 (LSB)	0bbb bbbb (MSB)	Pitch Bender MSB LSR MAX (high) 127 96 CENTER 64 0 MIN (low) 0 0
1011 nnnn	0000 0001	0111 1111	LFO Modulation On
1011 nnnn	0000 0001	0	LFO Modulation Off

1.3 When MIDI FUNCTION is 3.

Messages in FUNCTION 1, Bender, LFO Modulation and Exclusive Messages are sent.

2. RECOGNIZED RECEIVE DATA

2.1 When MIDI FUNCTION is 1.

When power is first applied, receiver's mode is OMNI ON, POLY mode.

Notes events, Hold on/off and Channel Mode Messages are recognized.

Status	Second	Third	Description
1000 nnnn	0kkk kkkk	0vvv vvvv	Note OFF, velocity ignored
1001 nnnn	0kkk kkkk	0000 0000	Note OFF kkkkkkk = 0 - 127 (24 - 108)
1001 nnnn	0kkk kkkk	0vvv vvvv	Note ON kkkkkkk = 0 - 127 (24 - 108) vvvvvvv = 1 - 127, velocity ignored
1011 nnnn	0100 0000	0	hold OFF
1011 nnnn	0100 0000	0vvv vvvv	hold ON vvvvvvv = 1 - 127
1011 nnnn	0111 1011	0	ALL NOTES OFF
1011 nnnn	0111 1100	0	OMNI OFF
1011 nnnn	0111 1101	0	OMNI ON
1011 nnnn	0111 1110	0mmm mmmm	MONO ON
1011 nnnn	0111 1111	0	POLY ON

Notes:

Mode messages (123 - 127) are also recognized as ALL NOTES OFF.
 The JUNO-106 does not respond to MONO ON message.

Mode messages are recognized as follows:

Mode	voice messages	mode messages
OMNI OFF (*7C)	OMNI = OFF : POLY	OMNI = OFF : POLY
OMNI ON (*7D)	OMNI = ON : POLY	OMNI = ON : POLY

Recognized channels are as follows:

mode	voice messages	mode messages
OMNI OFF mode	basic channel only	basic channel only
OMNI ON mode	all channels	basic channel only

2.2 When MIDI FUNCTION is 2.

Messages in FUNCTION 1, Program Change, Bender and LFO Modulation are recognized.

Status	Second	Third	Description
1100 nnnn	0ppp pppp		Program Change 0 - 63 : Group-A 11 - 88 64-127 : Group-B 11 - 88
1110 nnnn	0b00 0000	0bbb bbbb	Pitch Bender LS B bits are ignored
1011 nnnn	0000 0001	0vvv vvvv	LFO Modulation v = 0 (min) --> 127 (max)

note: Sensitivity of the pitch bender and modulation can be adjusted by receiver.

2.3 When MIDI FUNCTION is 3.

Messages in FUNCTION 2 and EXCLUSIVE messages are recognized.

3. EXCLUSIVE MESSAGES

3.1 When Group, Bank or Patch number is changed.

byte	description
a 1111 0000 \$FO	Exclusive
b 0100 0001 \$41	Roland ID #
c 0011 0000 \$30	function type
d 0000 nnnn \$0N	N+1 = MIDI channel, N = 0 - 15
e 0xxx xxxxx	Program number 0 - 127
f 0zzz zzzz	value 0 - 127 (18 bytes total for values)
g 1111 0111 \$F7	EOX

*** Example ***

```

a b c d e f f f
FO 41 30 00 00 39 2D 00 37 00 55 00 00 00
f g
19 34 3B 20 56 28 00 1A 18 F7
    
```

3.2 When Manual Button is pressed.

byte	description
a 1111 0000 \$FO	Exclusive
b 0100 0001 \$41	Roland ID
c 0011 0001 \$31	function type
d 0000 nnnn \$0N	N+1 = MIDI channel, N = 0 - 15
e 0000 0000 \$00	Number indicates "Manual"
f 0zzz zzzz	value 0 - 127 (18 bytes total for values)
g 1111 0111 \$F7	EOX

*** Example ***

```

a b c d e f f g
FO 41 31 00 00 03 00 00 00 00 3F 3C 00 00
f g
7F 45 00 00 7F 00 00 2A 19 F7
    
```

3.3 When volume controllers or switches are changed.

byte	description
a 1111 0000 \$FO	Exclusive
b 0100 0001 \$41	Roland ID
c 0011 0001 \$32	function type
d 0000 nnnn \$0N	N+1 = MIDI channel, N = 0 - 15
e 0yyy yyyy	parameter number 0 - 17
f 0zzz zzzz	value 0 - 127
g 1111 0111 \$F7	EOX

*** Example ***

```

a b c d e f g
FO 41 32 00 03 04 F7
    
```

3.4 Parameter number table

* for potentiometers

p #	function	p #	function
0	LFO rate	8	VCF LFO
1	LFO delay	9	VCF KYBD
2	DCO LFO	10	VCA level
3	DCO PWM	11	attack
4	noise level	12	decay
5	VCF cutoff	13	sustain
6	resonance	14	release
7	VCF ENV	15	sub level

* for switches

bit	6	5	4	3	2	1	0
16	chorus	chorus	saw	pulse	range		
1:	1:off	1:on	1:on	1:on	100 : 4'		
0:	2:0:on	0:off	0:off	0:off	010 : 8'		
					001 : 16'		
17	0	0	HP filter	VCA	ENV	PWM	
			11: off	1:gate	1:-	1:MAN	
			10: 1	0:ENV	0:+	0:LFO	
			01: 2				
			00: 3				

HS-60

Part 2

85-2-E3

Roland®

10496

UPC

10496



1998

Roland®