

 Roland®

JP-6

Owner's Manual

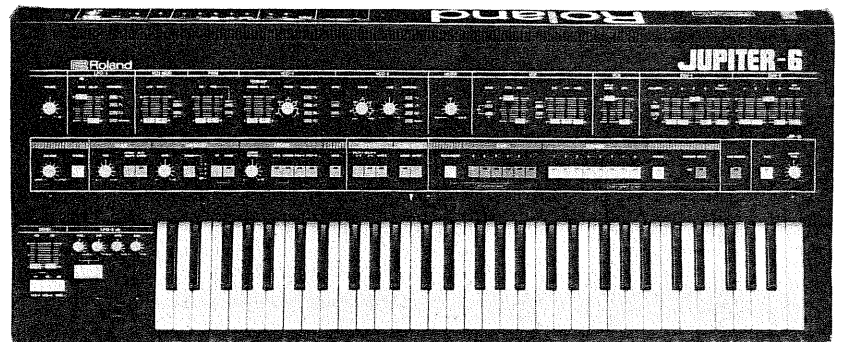

JUPITER-6

PROGRAMMABLE POLYPHONIC SYNTHESIZER

FEATURES

- The Jupiter-6 (JP-6) is the 61 key, 6 voice, 12 VCO polyphonic synthesizer that offers an exceptionally wide variety of rich sounds, therefore greatly expands the performance capabilities.
- The JP-6 includes memory capacity to retain up to 48 different synthesizer patches. (P. 22)
- Any program in memory can be temporarily edited during live performance. (P. 13)
- You can write a Tone color and various effect modes into any of the 32 Patch Preset memories, for quickly using them later, during live performance. (P. 14)
- Battery back-up system to retain the memory even when switched off. (P. 26)
- DETUNE function allows a powerful ensemble effect in SOLO UNISON or UNISON mode.
- A quick tuning of all the 12 VCO's is possible by the automatic tuning function. (P. 13)
- By changing the Key Mode (WHOLE, SPLIT-1 & SPLIT-2) and Key Assign (POLY-1, POLY-2, UNISON, SOLO and SOLO-UNISON), various attractive effects will be obtained.
- Many different Arpeggio effects are available by controlling the Arpeggio MODE and RANGE.
- The tape interface enables you to save the 48 Patch Programs and 32 Patch Preset memories into an ordinary tape recorder for storage and later retrieval.
- The Manual Section includes various interesting functions such as Cross Modulation, Synchronization, chromatic Range adjustment, intensity control of the Key Follow effect, Patch Shift function, etc.
- If connecting a Pedal Switch to the PATCH SHIFT jack, you can call 8 Patch Memories within a Bank one after another, simply by pressing the pedal.
- The DIN jack (OUT/IN) for MIDI standard external device.
- ★ It is necessary for you to clearly understand all the functions of the JP-6 to make the best use of it. Please read this owner's manual carefully in operating your JP-6.

► The JP-6 includes 3 main sections.

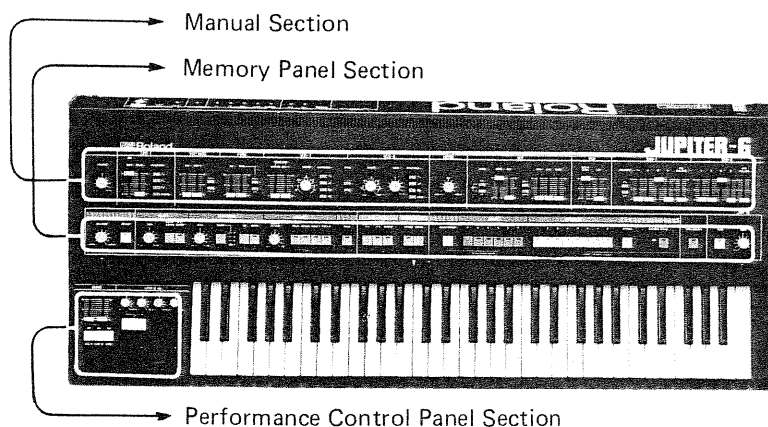

Manual Control Section

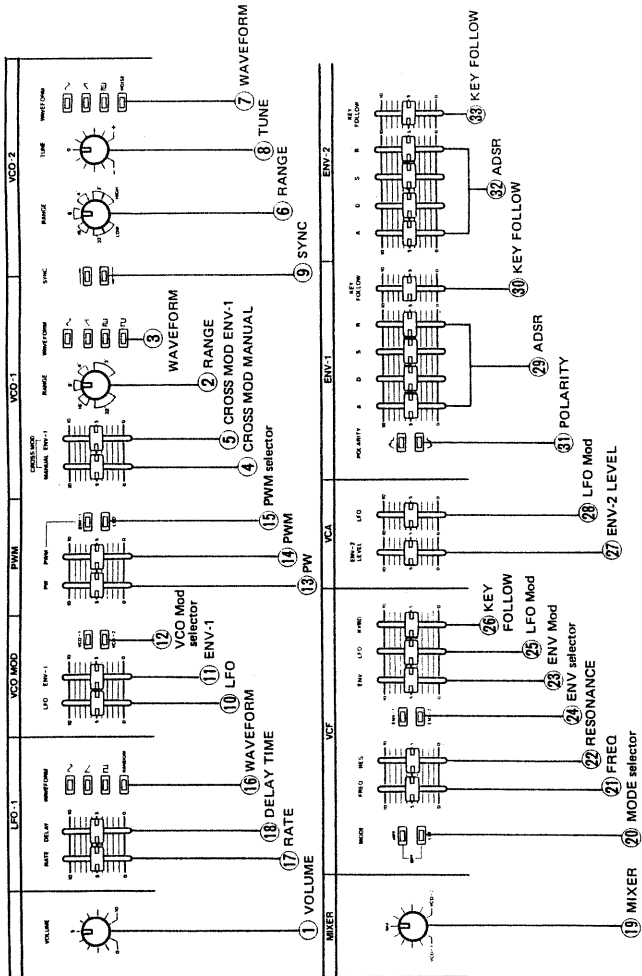

Performance Control Section

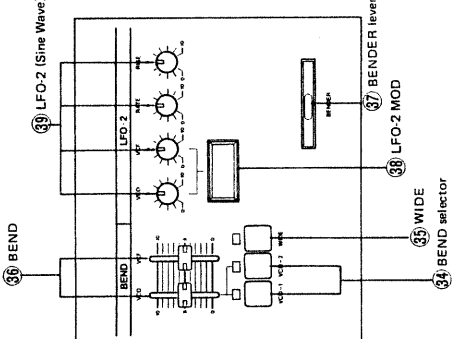

Contents

- Basic Connections 5
- III. Performance Control Section 20
 - Control Panel 20
- IV. Performance Control in the Memory Panel Section 6
 - Performance with a Patch Memory 6
 - Selecting a Patch Memory 6
 - KEY MODE (SPLIT, WHOLE) 6
 - BALANCE 8
 - ASSIGN 8
 - ARPEGGIO 10
 - HOLD 11
 - ARPEGGIO & HOLD 12
 - GLIDE 13
 - BENDER 13
 - AUTO TUNE 13
 - EDIT 13
 - Performance with a Patch Preset 14
 - OPERATION 14
 - EDIT 15
- II. Manual Control Section 16
 - VOLUME 16
 - VCO-1 16
 - VCO-2 16
 - VCO MODULATOR 17
 - PWM 17
 - LFO 17
 - MIXER 18
 - VCF 18
 - VCA 19
 - ENV-1 19
 - ENV-2 19
- V. Writing into a Patch Preset 26
 - (A) SAVE 27
 - (B) VERIFY 30
 - (C) LOAD 31
- VII. External Control 33
- VIII. Arranging the Data 34
 - (A) Using the Copy function 34
 - (B) Using the Tape Memory function 34
- SPECIFICATIONS 38
- OPTIONS 39

Basic Connections

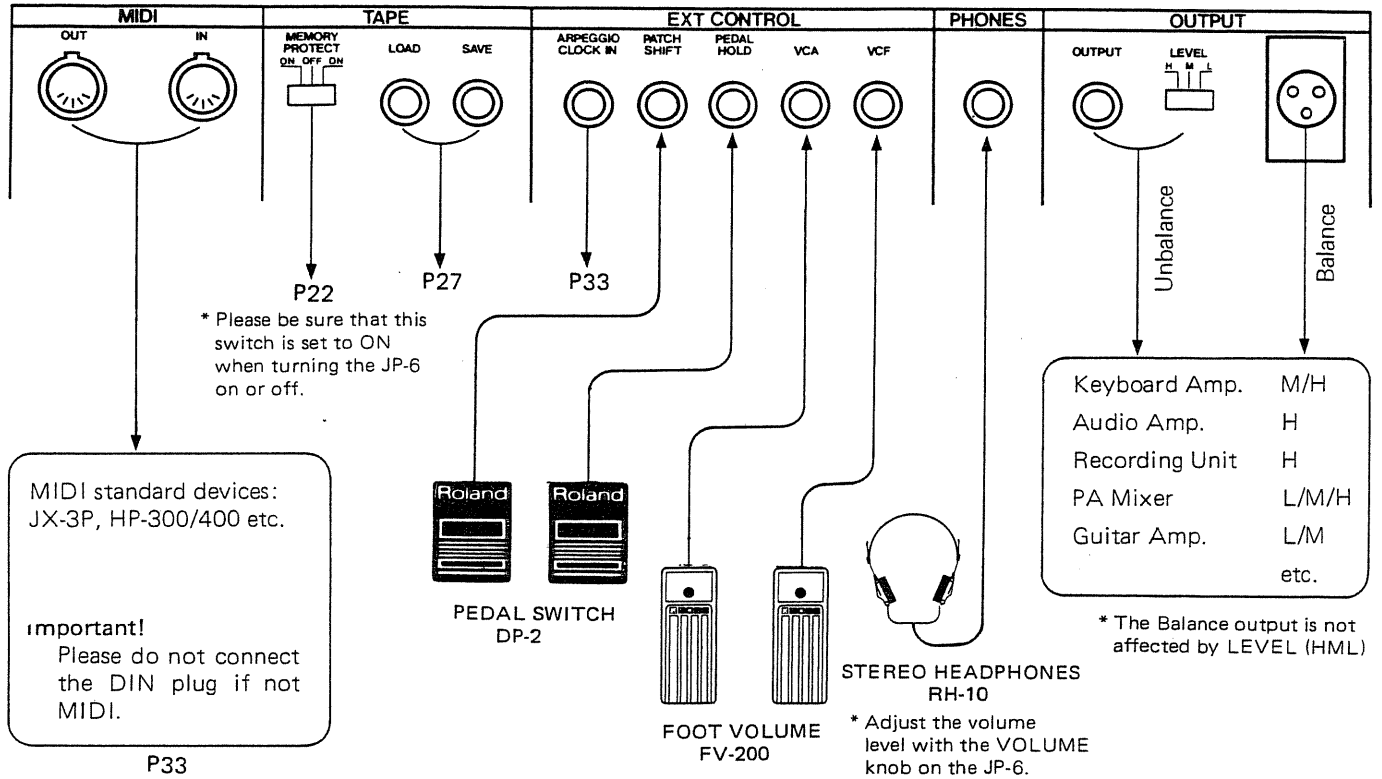

Bescheinigung des Herstellers /Importeurs

hiermit wird bescheinigt, daß der/die/das

6 VOICE POLYPHONIC SYNTHESIZER JP-6

(Gerät, Typ, Bezeichnung)

in Übereinstimmung mit den Bestimmungen der

Vfg 1046 / 1984

(Amtsblattverfügung)

funkt-entstört ist.

Der Deutschen Bundespost wurde das Inverkehrbringen dieses Gerätes angezeigt und die Berechtigung zur Überprüfung der Serie auf Einhaltung der Bestimmungen eingeräumt.

Roland Corporation

Name des Herstellers/Importeurs

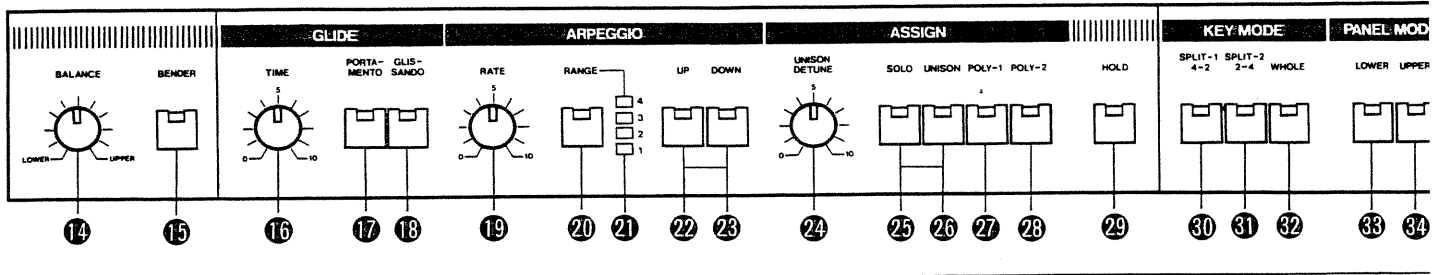

I Performance Control in the Memory Panel Section

The Memory Panel section includes various performance control functions. By using any of the 48 pre-programmed Patch Memories or your own synthesized patch with the various effects such as an Arpeggio or Glissand etc., wide variety of

performance is available. Also, you can write this into a Patch Preset for quick retrieval later in live performance.

The JP-6 offers even more attractive functions, please read this manual and explore them.

Performance with a Patch Memory

Selecting a Patch Memory

Press the PATCH PRESET button ❶ to turn it off. (The indicator goes out.) Then select any Patch Memory you like with the BANK button ❸ and Patch Number button ❹.

*By connecting a Pedal Switch (DP-2 etc.) to the PATCH SHIFT jack, the Patch Shift function is available (P. 33), i.e. each time you press the Pedal, the Patch Number (in the same Bank) changes as 1 → 2 → 3 → 4 → 8 → 1 →

▶Example (B-3)

Patch Memory B-3

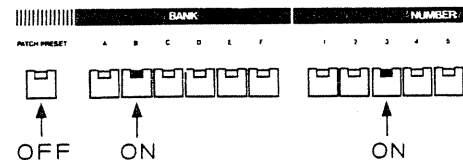

* Please explore other Patch Memories, too.

KEY MODE

SPLIT mode

You can split the keyboard into LOWER and UPPER sections where even two different tone colors and mode settings can be assigned. So the JP-6 can be played as two polyphonic synthesizers. Press the SPLIT-1 button or the SPLIT-2 button to select this mode.

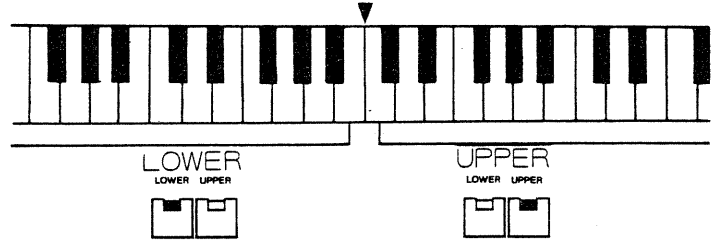
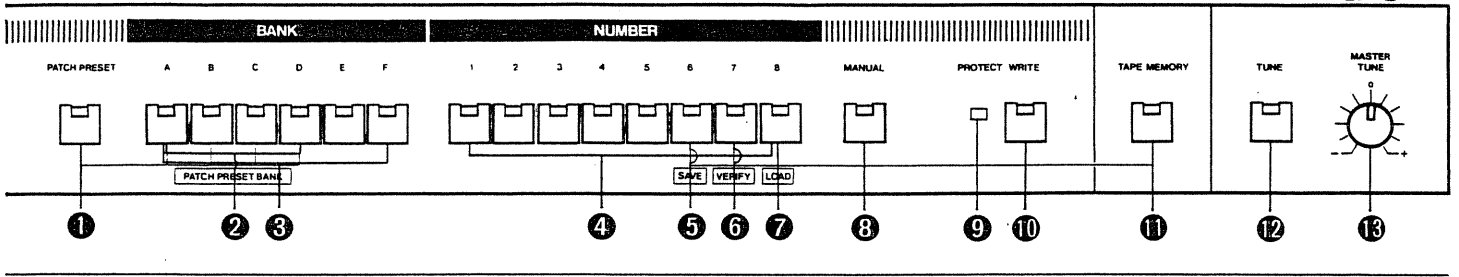

Press the UPPER button **34** then set the UPPER section to your taste. If setting the LOWER section, press the LOWER button **33**.

*In the SPLIT-1 mode, 4 voices are assigned to the LOWER section and 2 voices to the UPPER.
In the SPLIT-2 mode, 4 voices are assigned to the UPPER section and 2 voices to the LOWER.

►Setting Example

	TO NE CO LO R	AS SI GN	AR PE GG IO	GL ID E	BE ND ER
UPPER LOWER UPPER 	Organ-like sound	POLY-1 POLY-2 	OFF	TIME PORTA-MENTO GLIS-SANDO 3 	ON
LOWER LOWER UPPER 	Piano-like sound		RATE RANGE UP DOWN 4~5 2 U&D 	OFF	OFF

*Split Point is where the keyboard is split into UPPER and LOWER sections.
This Split Point is automatically set at ▼mark when the JP-6 is turned on.

*If you press the UPPER or LOWER button, the indicators of the Patch Memory and mode buttons light up displaying how each section has been set.

The Split Point when the JP-6 is turned on.

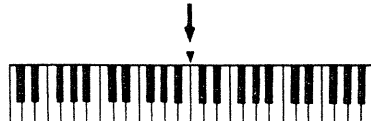

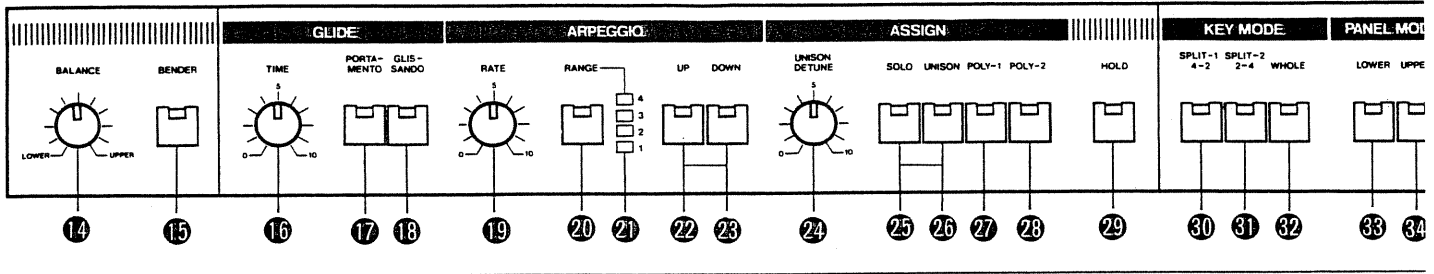

■ **Changing the Split Point**
 In the SPLIT mode, the Split Point can be set at any place you like by the following procedures.

Operation
 While holding either the SPLIT-1 or SPLIT-2 button down, press any key you like, and the key will be the lowest note in the UPPER section.

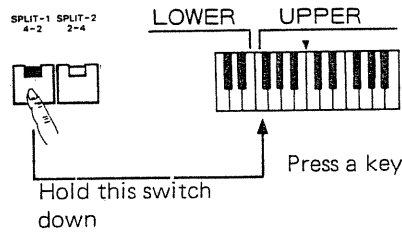

WHOLE mode

In this mode, the JP-6 entire keyboard will react to one patch as a single 6 voice synthesizer. Press the WHOLE button 32.

*When you change from the WHOLE mode to the SPLIT mode, the patch and the mode settings of the WHOLE mode

* If you press the different keys one after another while holding the SPLIT button, the first key will have the priority. (The first key will be the lowest note in the UPPER section.)

* The Split Point you have set will stay until you turn the JP-6 off or set a new Split Point.

* The Split Point you have set cannot be written in the Patch Preset. (P. 26)

will stay in the UPPER section unchanged. The LOWER section, however, differs.

* If you change from the SPLIT mode to the WHOLE mode, the patch and the mode settings of the UPPER section will stay in the WHOLE mode.

BALANCE

This sets the volume level balance of the UPPER and LOWER sections in the SPLIT mode. Rotating it clockwise (↻) increases the volume level of the UPPER and counterclockwise (↺) has the opposite effect.

ASSIGN

The four ASSIGN mode selectors determine how the 6 synthesizer voices available within the JP-6 will be applied to the keys played. The ASSIGN mode and Key mode have a certain relation.

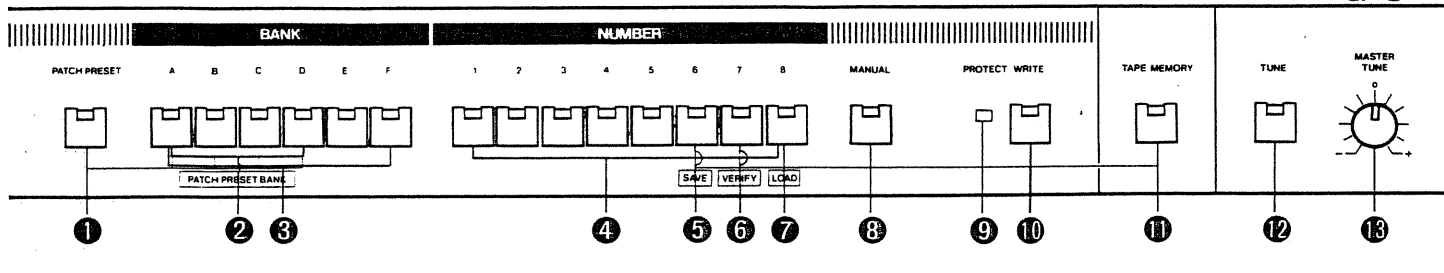

SOLO

SOLO



The SOLO Assign mode turns the JP-6 into a single voice synthesizer following Last Note Priority.

* LAST NOTE PRIORITY

The Lower Note Priority is that the lower key is selected when more than two keys

are being played. The Higher Note Priority is the opposite. If the last note pressed has the priority, it is called the Last Note Priority, and this is adopted in the JP-6 SOLO mode. This Last Note Priority function allows an interesting solo performance, i.e. if you hold a key down and alternately press and release another key, the key being held down and the other key will alternately sound.

UNISON

UNISON



Maximum synthesizer voices applied to one key changes depending how many keys you are pressing.

- 1 key → 6 voices
- 2 keys → 3 voices each
- 3 keys → 2 voices each
- 4 ~ 6 keys → 1 voice each

Also, by adjusting the DETUNE knob 24, an ensemble effect will be obtained.

This effect is not available when more than 4 keys are pressed.

* In the SPLIT mode, maximum voices applied to one key will be as follows.

- 4 notes
- 1 key → 4 voices
- 2 keys → 2 voices each
- 3 ~ 4 keys → 1 voice each

- 2 notes
- 1 key → 2 voices each
- 2 keys → 1 voice each

SOLO UNISON

SOLO UNISON



UNISON DETUNE



To turn the JP-6 into this mode, press the SOLO button 25 and the UNISON button 26 at the same time. Now the

JP-6 is turned to a monophonic synthesizer, and in the WHOLE mode, all 6 synthesizer voices will be assigned to each key (In the SPLIT mode, 2 or 4 synthesizer voices will be assigned to each key.). As you turn the DETUNE knob 24 clockwise (↻), the pitch differences increase and the ensemble effect will be more intensive.

POLY-1

POLY-1



This mode turns the JP-6 to a 6 voice polyphonic synthesizer assigning one synthesizer voice to each key pressed. It is suitable for the sound whose envelope curve is similar to Piano or Guitar etc., but not appropriate for the Portamento effect.

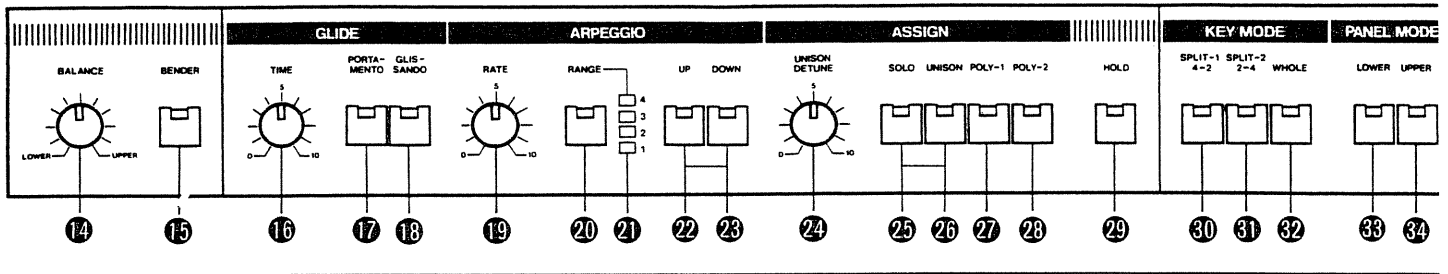

POLY-2

This is very similar to POLY-1 assigning only one synthesizer voice to each key pressed. The primary advantage of POLY-2 is that only the last note or notes played together receive their natural release length. This mode is suitable for the performance with the Portamento or Glissando effect.

ARPEGGIO

The JP-6 will sequence any notes played on the keyboard in the order that they are pressed within the Arpeggio range of 4 octaves.

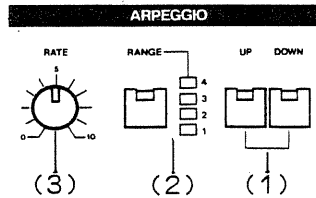

(1) Arpeggio Mode

There are following 4 modes and you can select any of those simply by pressing the button.

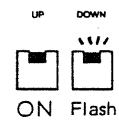
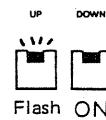
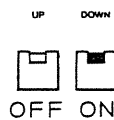
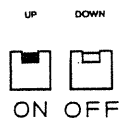

- a) UP
Turn only the UP button 22 on.
- b) DOWN
Turn only the DOWN button 23 on.
- c) UP & DOWN
While pressing the UP button 22, press the DOWN button 23. The indicator of the UPPER button flashes and that of the DOWN button lights up showing that it is now in the U & D mode.

- d) DOWN & UP
While holding the DOWN button 23 down, press the UP button 22. The indicator of the DOWN button flashes and that of the UP button lights displaying that it is in the D & U mode.

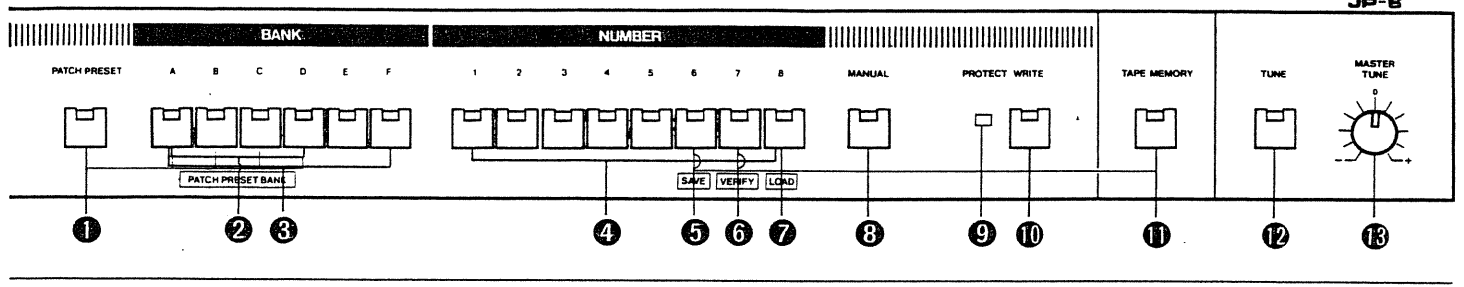

(2) RANGE

This button sets the range of the Arpeggio. Each time you press this RANGE button 20, its indicator will change 1 → 2 → 3 → 4 → 1 Those figures indicate the ranges as shown beside.

- 1 = 1 octave
- 2 = 2 octaves
- 3 = 3 octaves
- 4 = 4 octaves

(3) Arpeggio RATE

This knob determines the rate of the Arpeggio. Rotating this clockwise (↻) quicken the rate.

▲ By controlling those buttons and knob, wide variety of Arpeggios are available.

《NOTE》

Setting different Arpeggio Modes and Ranges is possible in the SPLIT mode. The Rate works in common for both the UPPER and LOWER sections.

* If you wish to stop the Arpeggio playing, press any one of the four Assign buttons.

* Unless you turn the Hold function on, and Arpeggio will be only repeated while keys are pressed.

* By connecting a rhythm unit to the ARPEGGIO CLOCK IN, the Arpeggio pattern will perfectly synchronize with its rhythm.

HOLD

When the HOLD button 29 is turned on, the sound remains even after you release the key. The level of the sound is determined by the Sustain level you have set in the ENV. (P. 19). Therefore, you cannot hold a sound with Sustain level of zero.

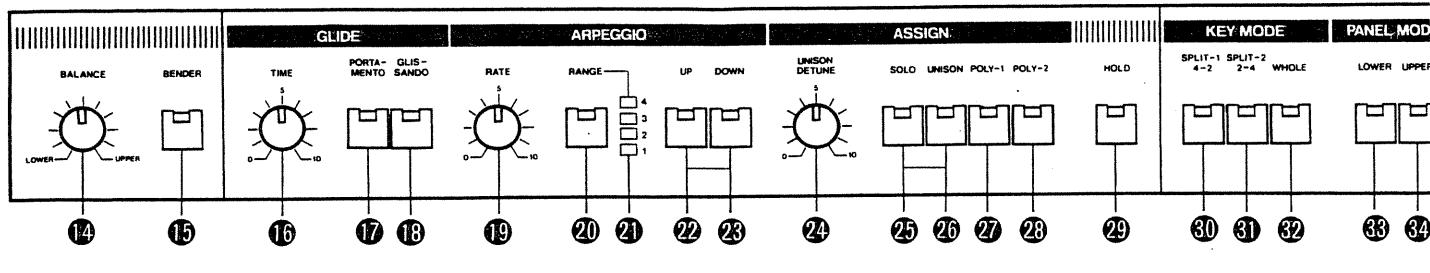

Operation

Turn the HOLD button 29 on, and press it again to turn it off.

* In the SPLIT mode, you can turn the Hold function on or off separately in the UPPER and LOWER section. In this case, turn the LOWER or UPPER button on, then the HOLD button. Up to 6 notes can be held at a time. If you release the keys once and press other keys, the previous notes will be replaced with the ones newly played.

* By connecting the Pedal Switch DP-2 to the JP-6 (P. 33), you can turn the Hold function on or off by using the Pedal Switch. Any 6 notes pressed last will be held if you keep changing the chords.

Also, in the SPLIT mode, the Hold function is available only in the section where its indicator (LOWER or UPPER) lights.

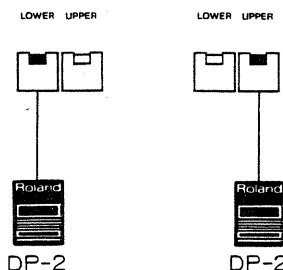

ARPEGGIO & HOLD

If you press the HOLD button 29 while an Arpeggio is being played, it will be repeated until a new chord is played.

* This Arpeggio and Hold function is also obtained by using the Pedal Switch DP-2. This is effective for the sound whose envelope curve is similar to the Piano's, etc. Also, in the SPLIT mode, this function is obtained only in the UPPER or LOWER section whose indicator lights.

GLIDE

The Portamento effect will be on by pressing the PORTAMENTO button 17. Pressing the GLISSANDO button 18 will turn the Glissando effect on. It is not possible to turn both effects on at the same time. The time of the Portamento or Glissando can be controlled with the Glide TIME knob 16.

* In the SPLIT mode, you can turn the Portamento or Glissando effect on in either section, UPPER or LOWER. The Glide TIME knob, however, will work commonly for both.

* POLY-2 key mode is most suitable for these effects.

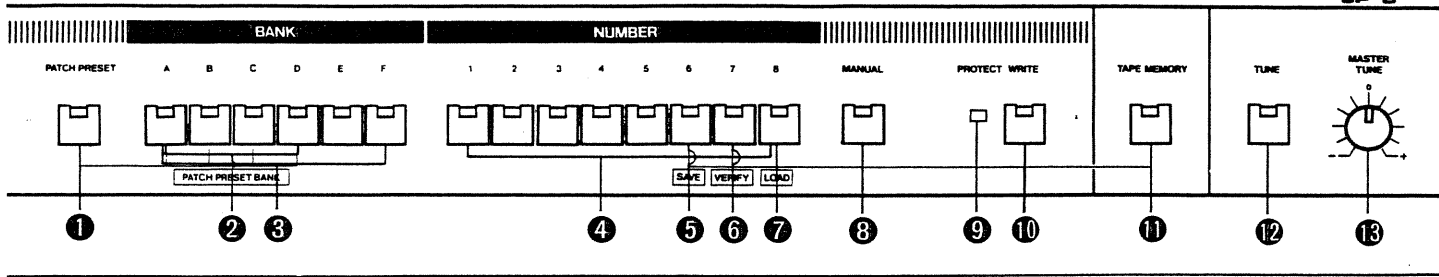

BENDER

Turn the BENDER button **15** on if controlling the Control Panel section (P. 20)

* In the WHOLE mode, the BENDER button will be always on.

* In the SPLIT mode, you can turn this bender button on or off separately in the UPPER and LOWER sections.

* Also, in the SPLIT mode, if you use the Foot Volume FV-200 to control the VCF, it will have an effect on the section where the BENDER button has been turned on. Whether this BENDER button is turned on or off does not affect the VCA control with the Foot Volume.

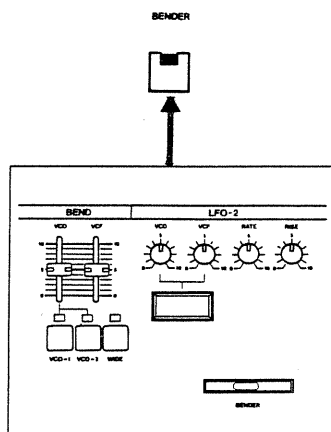

Auto TUNE

If you notice pitch differences among the VCO's, simply press the Auto TUNE button **12**, then 12 VCO's will be immediately tuned automatically.

* The moment the JP-6 is switched on, tuning is automatically done. The JP-6 may be detuned if its body temperature changes, so tuning will be necessary even after switched on.

* The overall tuning can be done with the MASTER TUNE knob **13**.

EDIT

You can edit any patch program in use as you play by moving the controls in the Manual Section. The indicators of the Patch Number you are editing will light up displaying that.

* This Edit function may be used as a real time performance control since this Edit function does not automatically rewrite the existing program, unless the appropriate procedure for rewriting is done. (Refer to P. 22). Therefore, if you select the same Patch Program later, you will hear the original tone color unchanged.

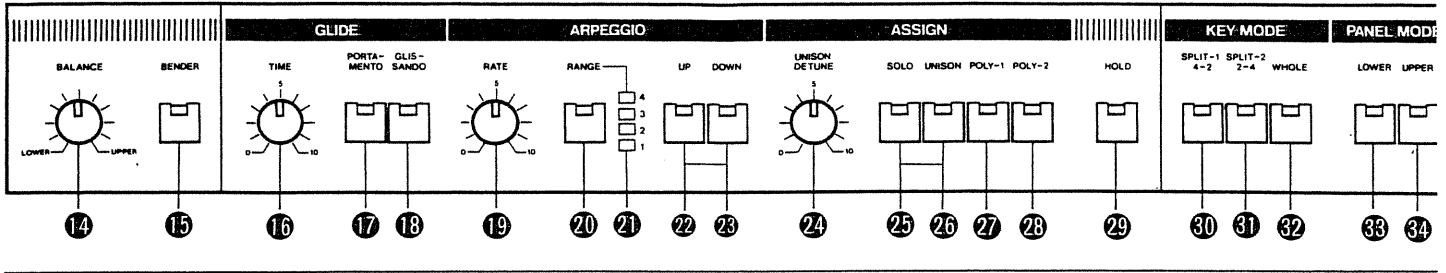

«NOTE»

If the PATCH PRESET button 1 is turned on, the same BANK and Patch Number (e. g. A-1) will sound completely different. i.e. the Patch Preset of A-1 is in use instead of the Patch Memory A-1.



Check if this button is ON or OFF.

Performance with a Patch Preset

The Patch Preset function allows you to write a tone color and various effect modes into a Patch Preset (or even one pair of tone colors and two different mode setting in the SPLIT mode). There are 32 Patch Presets and any of these can be in use just by pressing the buttons.

* By using a Pedal Switch (DP-2, etc.), the Patch Shift function is made available. Each time you press the Pedal, the Patch Preset Number will change as 1 → 2 → 3 → → 8 → 1, i.e. you can call the Patch Presets in the same Bank one after another during live performance.

Operation

Turn the PATCH PRESET button 1 on. (The indicator will light up.) Then select a Patch Preset by pressing a BANK button 2 and Patch Number button 4.

►Example

PATCH PRESET D-8

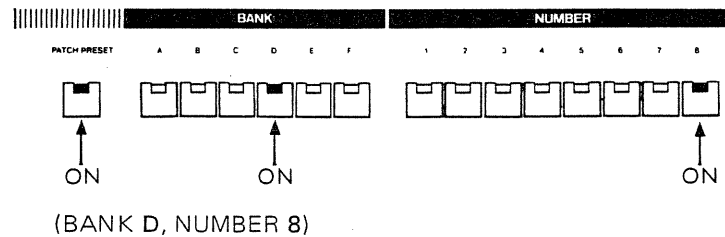

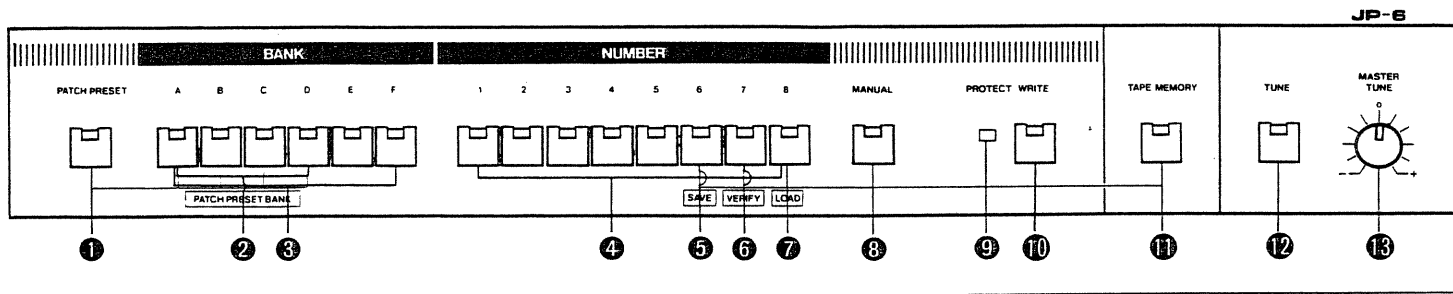

Editing the Patch Preset

You can edit any Patch Preset in use as you play. While editing a Patch Preset by using the controls in the Memory Panel section, the indicator of the PATCH PRESET will flash. If you are editing a Patch Preset by using the controls in the Manual Section, no indicator flashes. If you turn the PATCH PRESET button off at this stage, the indicators start flashing.

This is where a Patch Preset is edited.



* This Edit function may be used as a real time performance control since this Edit function does not automatically rewrite the existing program, unless the appropriate procedure for rewriting is done. (Refer to P. 26) Therefore, if you select the same Patch Program later, you will hear the original tone color unchanged.

► Example 1

Editing the Patch Preset A-1 with the controls in the Memory Panel section.

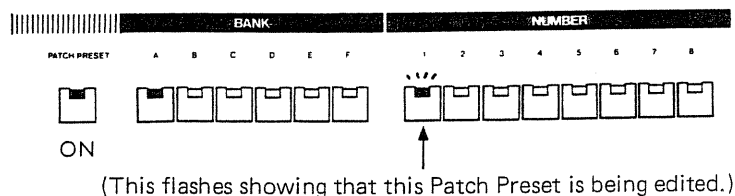

► Example 2

Editing the Patch Preset A-1 as you play with the controls in the Manual section.

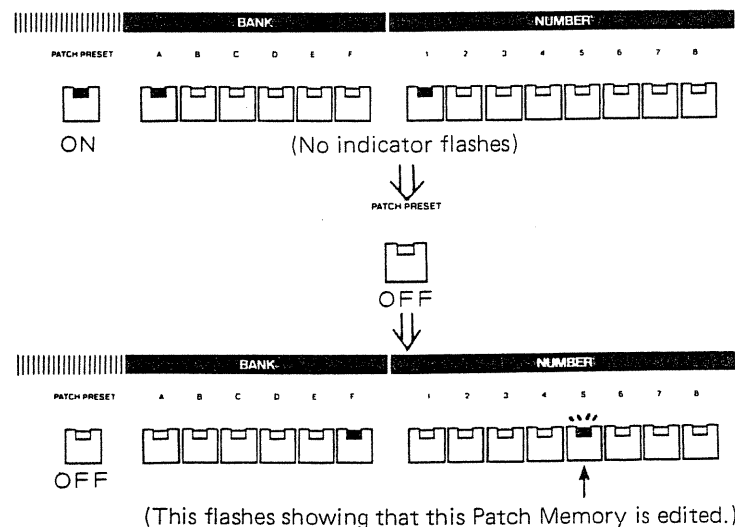

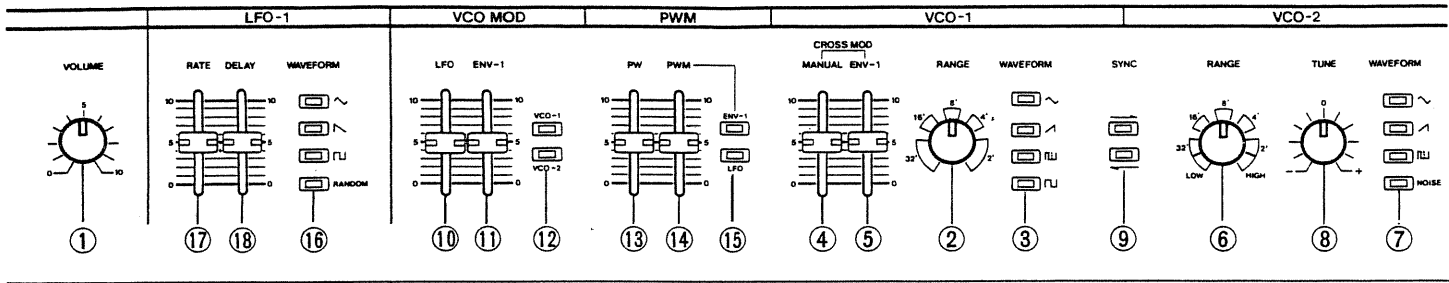

II Manual Control Section

* In this section, you can synthesize tone colors and save them into memory, or edit the Patch Memory previously written.

★When synthesizing in the Manual Control Section, turn the MANUAL button **⑧** on. If you wish to edit the Patch Memory, call it by pressing the BANK and Patch Number buttons, then edit it by using the controls within the Manual Control Section.

■ VOLUME

① VOLUME



This knob adjusts the overall volume. The volume level set here cannot be written in the Patch Memory.

■ VCO-1

② RANGE

This RANGE Control enables the pitch control of the VCO-1 in half steps as the rotary switch is swept through its range.

③ WAVEFORM

This is to select the output waveform of the VCO-1. It is even possible to mix the different waveforms by pressing the switches at the same time, but  and  cannot be mixed together.

④ CROSS MOD MANUAL

When modulating the VCO-1 by the output signal of the VCO-2, you can control the intensity of the modulation with this knob. If not using the VCO-2 as the sound generator, turn the MIXER **⑲** fully counterclockwise (↶).

* If the VCO-2 is set to function in its Low Frequency range (Refer to **⑥**), it will work as the LFO and the VCO-1 will produce more sophisticated modulation effects. Also, if the VCO-2 is in its normal audio range, the CROSS MODULATION of the VCO-1 will produce ring modulation style effects such as metallic sounds. This is useful for synthesizing the tone colors of bell or Japanese musical instruments, etc.

⑤ CROSS MOD ENV-1

When the output signal of the VCO-2 is modulating the VCO-1 and the signal is controlled by the ENV-1, this knob decides the intensity of the modulation.

* There may be no effect if the ENV-1 is set to . If so, please raise the MANUAL knob to an appropriate level.

■ VCO-2

⑥ RANGE

This sets the pitch range of the VCO-2. The pitch changes in half steps, as the rotary control is swept through its range. When this knob is set to LOW, the VCO-2

will produce only Low Frequency signals which are not audible (approx. 1.5 Hz ~ 50 Hz). If set to HIGH, the range will be higher than 2' ~ 1/2'.

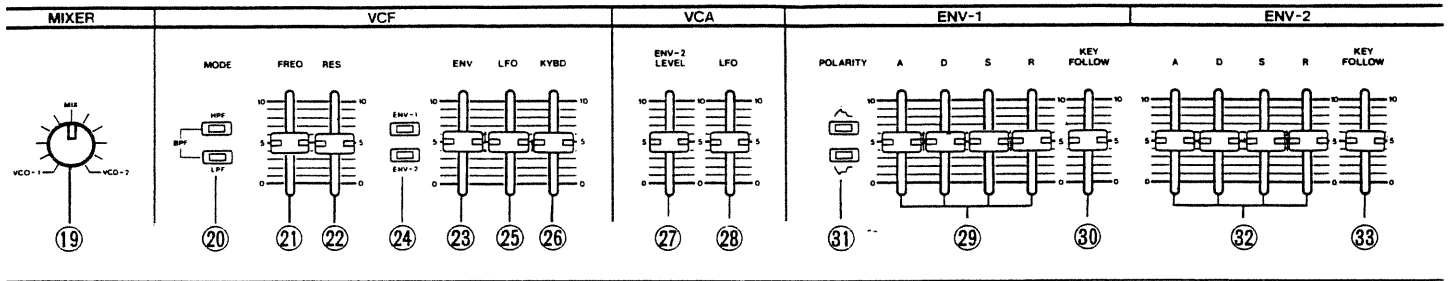

⑦ WAVEFORM

This selects the output waveform of the VCO-2. Like the VCO-1, it is possible to mix the different waveforms.

⑧ TUNE

This allows adjustment between the discreet half steps selected by the VCO-2 RANGE control. This has a variable range of ± 50 cent (1/4 note).

⑨ SYNC

This is used when synchronizing the VCO-1 and VCO-2. It is possible to synchronize the pitch of the VCO-1 to VCO-2, or that of VCO-2 to VCO-1 in both ways by changing the position of this switch. Also, using the CROSS MOD simultaneously will result in a wide variety of tone colors and effects.

■ VCO MODULATOR

⑩ LFO

This knob controls the amount of the LFO output signal modulating the VCO (depth of the vibrato effect).

⑪ ENV

This knob sets the amount of the ENV-1 output signal controlling the VCO.

⑫ VCO MOD Selector

By these two switches, you can select if the LFO modulation or the ENV modulation will be applied to either the VCO-1 or VCO-2 or both.

■ PWM

⑬ PW

This sets the width of the pulse wave. When this is set to 0, the duty of the pulse wave is 50 percent, i. e. the square wave (\square). As you raise the slider, the pulse width will be narrower. If this is set to 10, the duty will be 0 percent, i. e. there is no sound coming out.

⑭ PWM

This sets the intensity of the pulse width modulation by the LFO or ENV-1. By

controlling the pulse width, wide variety of tone colors are obtained.

* If the PW is set at 10, the pulse width modulation by the ENV-1 signal does not have any effect. Please adjust the PW.

⑮ PWM Selector

By pressing one of these switches, you can select the pulse width modulation by either LFO or ENV-1 signal.

■ LFO

⑯ WAVEFORM

These switches are used to select the LFO output signal. RANDOM will generate irregular voltage alteration.

⑰ RATE

This knob changes the rate (frequency) of the LFO. If raising this knob and selecting the RANDOM signal of the LFO, you can obtain the effect just like pink noise modulation.

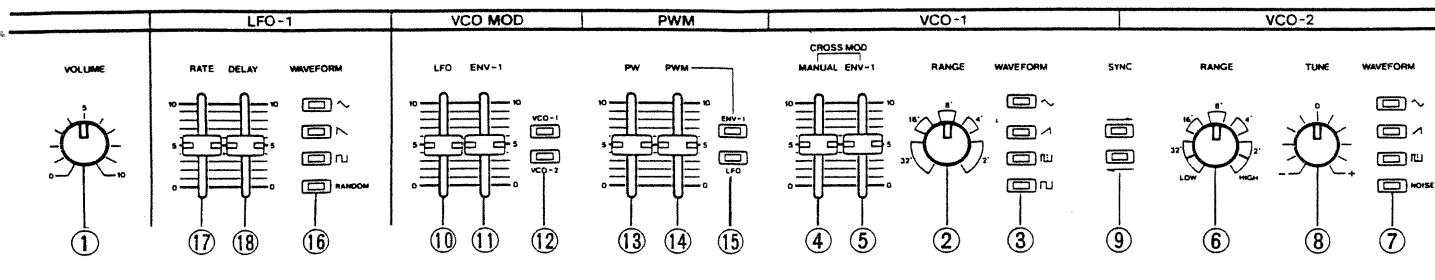

18 DELAY TIME

This sets the time required for the LFO signal to start working after the key is pressed. When it is set to 10, delay time is approximately 2.5 seconds. This Delay

function does not work unless the key is attacked for each note. Therefore, in legato, this is applied to only the first note. Also, this Delay function has no effect on PWM (14) and VCA (28)

MIXER

19 MIX

This is to mix the sounds from the VCO-1 and the VCO-2 at any proportion you like. Turning this counterclockwise (↺) increase the volume of the VCO-1 and

clockwise (↻) increases the VCO-2. If, however, the RANGE in the VCO-2 is set to LOW and this knob is turned fully clockwise (↻), there might be no sound heard.

VCF

20 MODE

If the HPF switch is pressed down, the VCF will function as a High Pass Filter, and if the LPF is pressed, as a Low Pass Filter. If both switches are pressed down, it will work as a Band Pass Filter.

21 FREQ

In the LPF mode, as you lower this knob, higher frequency will be blocked. In the HPF mode, raising the same knob will block lower frequency. In the Band Pass mode, raising this knob blocks the frequencies other than at the Cutoff Point.

22 RESONANCE

Raising this knob will emphasize the harmonics at the Cutoff Point. If controlling the VCF with this RES knob set to high, you can obtain a sort of tone color impossible to make with any other musical instrument.

23 ENV MOD

This knob controls the intensity of the ENV modulation over the VCF cutoff point. This, however, has no effect, if the FREQ knob (21) is set at 10.

24 ENV Selector

You can select between the ENV-1 or ENV-2 for the ENV modulation.

25 LFO MOD

This controls the amount of the LFO output signal modulating the VCF (the depth of the growl or wah effect).

26 KEY FOLLOW

This control the amount of the keyboard CV that changes the Cutoff Point of the VCF. Raising this knob makes higher notes brighter.

* The Jupiter-6 allows maximum of 120 percent over keyboard CV follow when this knob is set at 10.

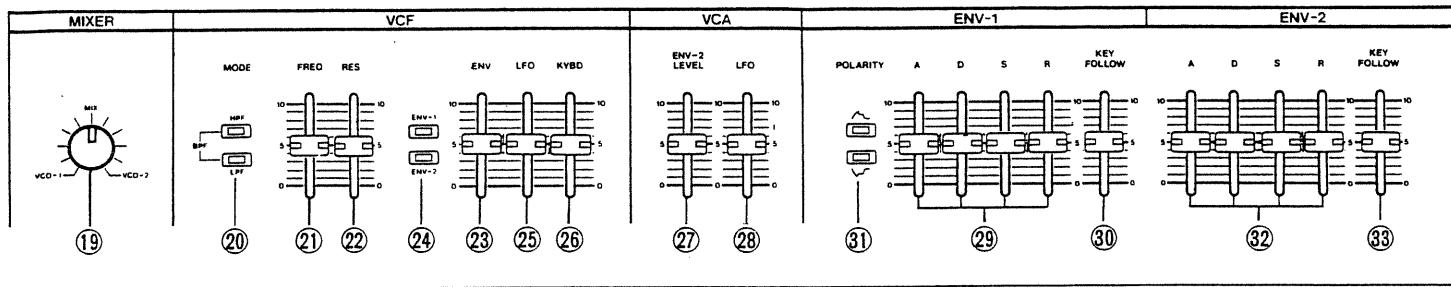

■ VCA

⑳ ENV-2 LEVEL

This is used for the volume control when the VCA is modulated by the ENV-2 output signal.

*When you are writing the tone colors, adjust the volume level (to your ears) to make them all sound in the same level for later comfortable listening.

《NOTE》

The JP-6 features excellent capability of sound synthesizing, so in some settings of the controls, sound distortion may occur because of its excessively high volume. If so, lower this knob.

㉑ LFO MOD

This knob is used to change the depth of the tremolo effect when the VCA is controlled by the LFO output signal.

■ ENV-1

㉒ ADSR

A: ATTACK TIME

This sets the time required for the voltage to reach its maximum from the moment the key is pressed down.

*When all of the ADSR knobs are set at zero, the waveform will be an extremely short Pulse wave, and only a short "click" is heard. Please be careful.

D: DECAY TIME

This determines the time required for the voltage to drop from the maximum to the level set by the Sustain Level. When the Sustain level is high, the envelope curve does not change by adjusting this knob.

㉓ KEY FOLLOW

Raising this knob makes the higher sound shorter. This is useful to generate realistic percussive sounds.

S: SUSTAIN LEVEL

This determines the Sustain Level to which the voltage falls at the end of the Decay Time.

㉔ POLARITY

This selects the polarity of the envelope curve. Normally this is set to ().

R: RELEASE TIME

This sets the time needed for the voltage to reach zero.

■ ENV-2

㉕ ADSR

These function exactly the same as ㉒ .

㉖ KEY FOLLOW

This functions the same as ㉓ .

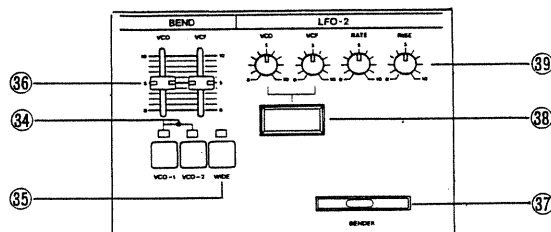

III Performance Control Sections

In this section, creative real time control is available by using the controls such as the BENDER or LFO-2.

*If the BENDER button **15** is off, the Performance Control Section does not work.

*When the Jupiter-6 is in the SPLIT mode, you can turn the BENDER button on or off in the UPPER and LOWER section separately.

*In the WHOLE mode, the BENDER button is always on.

■ Control Panel

34 BEND Selector

These are to turn on or off the Bender function. Each can be controlled separately.

35 WIDE

When this button is on, the Bender effect will be applied to the VCO-1 or VCO-2 whichever you have selected, and its maximum variable range will be more than 3 octaves. In this case, the indicator will turn to orange and the BENDER knob **36** will not work.

*Using this WIDE button with the CROSS MOD **4** or SYNC **9**, a unique effect can be obtained.

36 BEND

VCO: This sets the maximum Bender effect on the VCO.

VCF: This sets the maximum Bender effect on the VCF.

37 BENDER lever

Move this lever to change the pitch or tone color. At its center position, this has no effect on the Jupiter-6's sound or settings, while the left and right extremes of movement achieve the same amount of Bend in opposite directions.

38 LFO-2 MOD

This is to turn on or off the effects set by the controls in the LFO-2.

39 LFO-2 (Sine Wave)

VCO: This sets the depth of the vibrato effect when the LFO-2 is modulating the VCO. The output of the LFO is a sine wave (∩). Deep modulation is not available by this LFO-2 as this is just for the vibrato effect.

VCF: This sets the depth of the growl effect when the LFO-2 modulates the VCF.

RATE: This adjusts the rate (frequency) of the LFO-2. Turning it clockwise () raises the rate between approx. 1Hz ~ 10Hz.

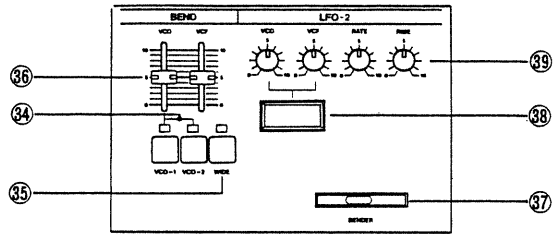

RISE TIME: This determines the time required for the LFO-2's modulation to reach the depth set by the BEND knob 36 in the Performance Control Section.

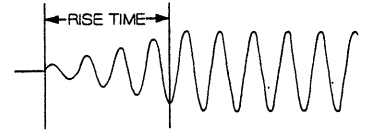

★Memory Protect Function

Please note that the MEMORY PROTECT switch should be set to ON except in writing mode.

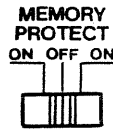

Please be sure to return this MEMORY PROTECT switch to the ON position right after writing is completed.

If the MEMORY PROTECT switch is set to ON, all internal memories will be protected, so you will be released from accidental loss of the patch memories. When this switch is set to the OFF position, i.e. if you are writing a new patch into memory, it may be a good idea to individually protect each patch during each writing operation.

►Memory Operation

(1)
Writing a new
Patch Memory
without Protect.

(2)
Writing a new
Patch Memory
with Protect.

 Press this button,
then select a Patch Memory.

 Hold this button and
Select a Patch Memory.

(a) If selecting a Patch Memory without Protect. Writing is completed.

(a) If Selecting a Patch Memory without Protect. Writing is completed.

(b) If Selecting a Patch Memory with Protect. The PATCH NUMBER button will flash.

(b) If Selecting a Patch Memory with Protect. The PATCH NUMBER button will flash.

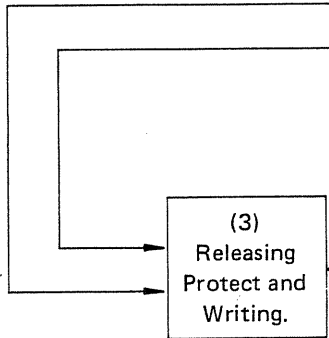

(a) Writing a new Patch Memory without Protect.
 Press the WRITE button then
press the Patch Memory buttons (BANK
and PATCH NUMBER) twice. Writing is completed.

(b) Writing a new Patch Memory with Protect.
 Hold the WRITE button down then
press the Patch Memory buttons (BANK
and PATCH NUMBER) twice. Writing is completed.

IV Writing your Original Patches into the Patch Memories

You can write the patch you have synthesized in the Manual Section or the edited patch into the Patch Memories. The old patch memory previously written is automatically deleted when you have completed writing a new patch memory.

(A) Writing in the WHOLE mode

(1) Writing without the Memory Protect function

- Set the Key Mode to WHOLE.
 - Turn the PATCH PRESET button ① off.
 - Press the MANUAL button ⑧ and synthesize your own sound or edit the existing Patch Memory by controlling the Manual Section.
 - Press the WRITE button ⑩. (The indicators of the Patch Number buttons will flash).
- * Pressing the WRITE button again will cancel this mode.
- By pressing the BANK button ③ and the Patch Number button ④, select the Patch Program to be written.
- (a) The indicators of the chosen Patch Memory light up and the indicator of the other NUMBER buttons go out, displaying that writing into a Patch Memory is completed.
- (b) If you select the Patch Memory that is protected, indicators of that Patch Memory will keep flashing, displaying that writing is not possible. If you wish to replace this Patch Memory with a new one, do as instructed in "(3) Releasing a Patch Memory from the Memory Protect and writing a New Patch (a) on P. 24".

* If you write the Edited patch into the same Patch Memory where it was originally written, the original Patch will be replaced with the Edited one. If you write this Edited patch into a different Patch Memory, both the original patch and edited one will be retained.

If writing the Edited patch into the same Bank, you do not need to press the BANK button, but if into the different Bank, it is strictly required to press the appropriate BANK button first, then Patch Number button. The indicators of this Edited Patch Memory light and other indicators flash, so that you can easily tell which Patch Memory is edited. If the writing is completed, those indicators light and other go out.

* If the MEMORY PROTECT switch is turned on, all the memories will be protected, but they can be accidentally lost by improper operation if turned off. So to be secured, it is recommended to protect the individual patch when writing it into memory as follows.

(2) Writing with the Memory Protect function

- Set the Key Mode to WHOLE.
- Turn the PATCH PRESET button ① off.
- Press the MANUAL button ⑧ and synthesize your own sound or edit the existing Patch Memory by controlling the Manual Section. While holding the WRITE button down, select the Patch Memory where you wish to write.

(a) The Memory Protect indicator will turn orange and the indicators other than the Patch Memory's go out, displaying that Writing with the Memory Protect is completed.

(b) If you have selected the Patch Memory that was written with the Memory Protect function, its indicator will keep flashing, showing that Writing is impossible. If you wish to replace this Patch Memory with a new one, do as instructed in "(3) Releasing a Patch Memory from the Memory Protect and Writing a New Patch (b)".

*When the MEMORY PROTECT switch on the rear panel is set to OFF, the Memory Protect indicator displays two different things by its color. A protected Patch Memory is shown by the orange light indicator and the green indicator means that the Patch Memory was written without the Protect. This is useful in arranging the order of the Patch Memories. (Refer to P. 34)

(3) Releasing a Patch Memory from the Memory Protect and Writing a New Patch

- Set the Key Mode to WHOLE.
- Turn the PATCH PRESET button ① off.
- Press the MANUAL button ⑧ and synthesize your own sound or edit a Patch Memory.

(a) Press the WRITE button, then select the Patch to be written by pressing the appropriate BANK button and Patch Number button twice. The Memory Protect indicator will turn green and the indicators other than the Patch Memory's go out, displaying that the new patch is written without the Protect.

► Example (a)

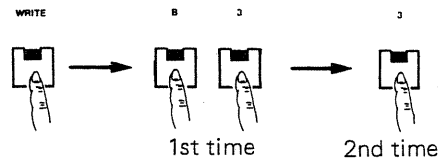

(b) While holding the WRITE button down, select a Patch Memory by pressing the relevant buttons twice.

► Example (b)

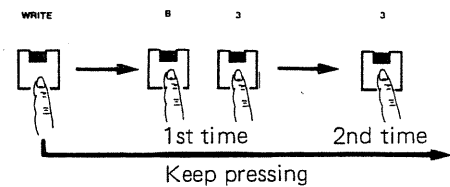

The Memory Protect indicator will turn to orange and other indicators go out, displaying that the new patch is written with the Protect.

★Setting the MEMORY PROTECT switch on the rear panel to ON will turn the Memory Protect indicator red. This displays that all the Patch Memories are now protected.

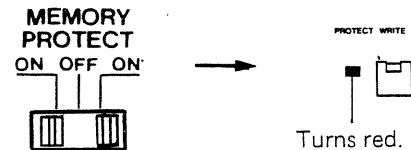

(B) Writing in the SPLIT mode

*In the SPLIT mode, you can write the tone color in either UPPER or LOWER section (where the indicator lights). By using this function, you can, for instance, call a Patch Preset and edit the tone color of the UPPER section only, then write this Edited patch into the same Patch Memory. In other words, you can call any Patch Preset you like and edit the tone color of only one section and write this Edited patch into the same Patch Memory.

►Example

PATCH PRESET A-1

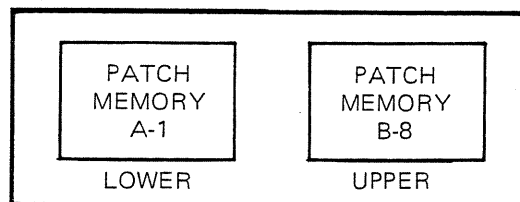

As you play Patch Preset A-1, edit the Patch Memory B-8.

PATCH PRESET A-1

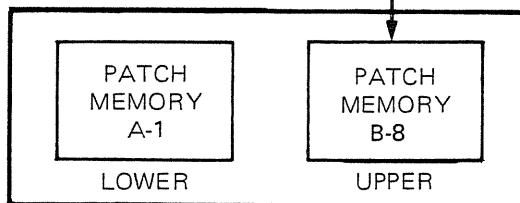

Write the Edit into B-8. The Patch Preset A-1 contains the same Patch Memories.

►Operation

- (1) Turn the PATCH PRESET button **1** off.
- (2) Set the Key Mode to SPLIT.
- (3) Select either LOWER or UPPER in the Panel Mode section. The tone color of the selected section can be edited and later written.
- (4) Now write the Edited patch just like writing in the WHOLE mode. Then the edited patch is written into the same Patch Memory.

V Writing into a Patch Preset

You can write two different tone colors and various modes into a Patch Preset. Up to 32 Patch Presets are available. In the SPLIT mode, each LOWER and UPPER section can have a different tone color and effect mode settings. This Patch Preset function enables extremely simple and quick retrieval of the desired Patch, which is specially useful during live performance.

►Operation

- (1) Select any Patch Memory you like or synthesize your own tone color, then set the effect modes to your taste.
- (2) Set the MEMORY PROTECT switch on the rear panel to OFF.
- (3) Turn the PATCH PRESET button on.
- (4) Press the WRITE button.
(The indicator will light up.)
- (5) Select the Patch Preset to be written by pressing the BANK button and the Patch Number button.

This Patch Preset function is just to remember the combination of the Patch Memories and modes. This has no ability of retaining the tone color itself, therefore, the Patch Preset will change if the Patch Memories in the Patch Preset are edited or new patches are written.

- (6) Set the MEMORY PROTECT switch ON.

*Now you have completed writing a Patch Preset. Refer to P. 14 for calling the Patch Preset in memory.

《NOTE》

The Jupiter-6 features battery back up system to retain the memory even when switched off. The batteries should be replaced with a new set in every five years. In this case, please have your local Roland dealer do the job. (The first replacement might be required before five years.)

VI Tape Memory

The Jupiter-6 contains the Tape Interface that enables you to save the Patch Memory and Patch Preset Data into an ordinary tape recorder.

Though the Patch Memories are protected by battery back-up system, it is better to save them into a tape to prevent accidental erasure of the important data.

► Connections

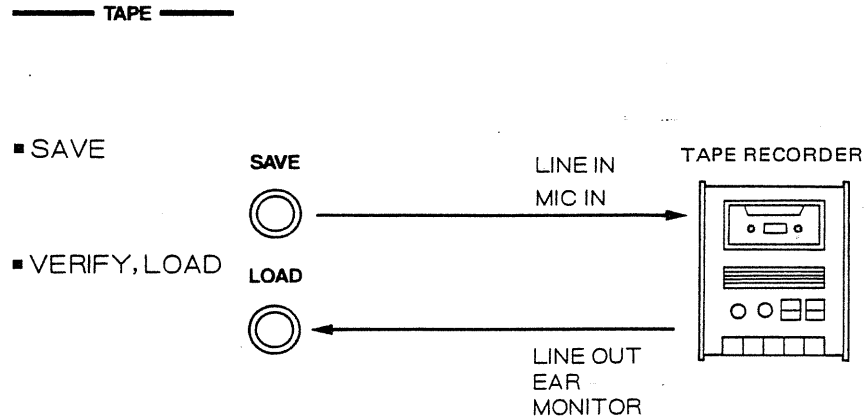

(A) SAVE

(1) Set the tape recorder to REC (recording mode).

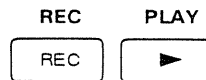

(2) While holding the TAPE MEMORY button **11** down, press the SAVE button **7**.

* If you put a Data Name to each data you are saving, later loading procedure will be considerably quickened. Any BANK button of A to F can be used as a Data Name.

After pressing the SAVE button, assign the Data Name (Bank A to F) quickly without releasing the TAPE MEMORY button.

If the Data are named B, C, D and A, and saved in a tape in the same order, you can load any one of these data much quicker just by pressing the relevant BANK button.

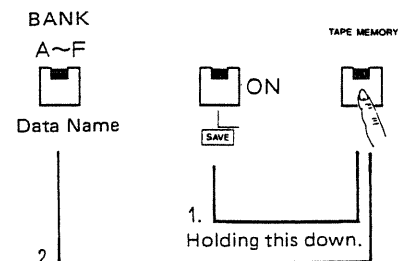

- (3) Release the SAVE button first, then the TAPE MEMORY button. The Pilot tone will be sent from the SAVE jack.

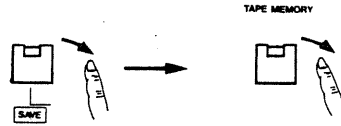
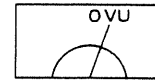

- (5) If the Pilot tone is heard again, saving is completed. Stop the tape recorder. (All these saving procedures take about thirteen seconds.)

- (4) If your tape recorder features the recording level control, adjust it so that the Pilot tone will register near 0 VU. In about five seconds, the JP-6 starts to produce a Modulated tone instead of the Pilot tone, i.e. saving into a tape recorder begins. (Be sure to complete adjusting the recording level before this Modulated tone is heard.)



«Saving a Bank»

You can save each Bank separately as well as all 48 patches together.

- (1) Set the tape recorder to REC (recording mode).
- (2) While holding the TAPE MEMORY button **11** down, press the SAVE button **7**.
- (3) Release the SAVE button first, then the TAPE MEMORY button. The Pilot tone will be sent from the SAVE jack.

* Please remember to release the SAVE button before the TAPE MEMORY button.

- (4) After releasing the TAPE MEMORY button **11**, choose any Bank you like quickly. (Complete this procedure before the Modulated tone starts.)

* If you wish to save a Patch Preset data, turn the PATCH PRESET button on when pressing the BANK button.

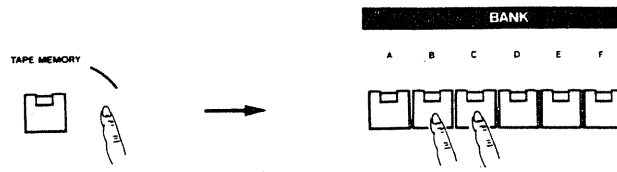

(You can select up to 6 BANKs.)

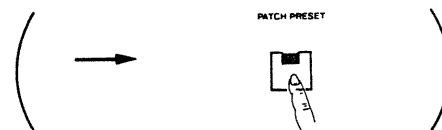

►Example

Pressing BANK button A will save the Patch Memories 1 to 8 in its Bank (8 patches), and pressing B and F will save the Patch Memories within the Bank B and F (16 patches).

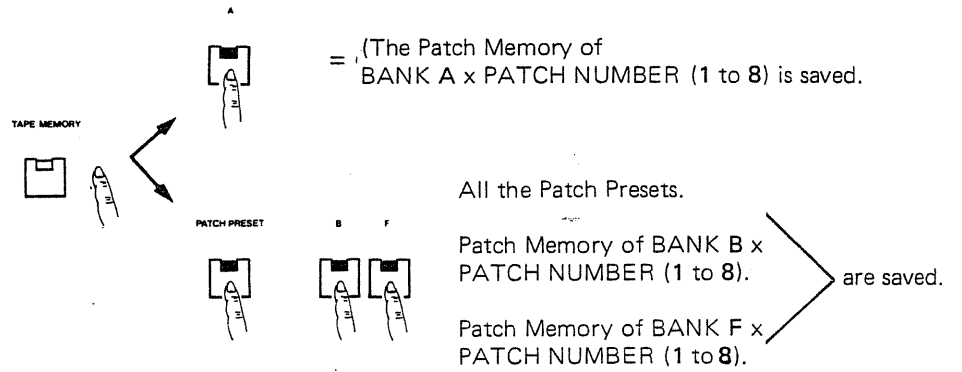

(5) If the Pilot tone is heard again, saving is completed. Stop the tape recorder.

(B) VERIFY

- (1) Set the tape recorder so that the tape will be played back from the very beginning of the recorded Data (where you hear a Pilot tone).
* If you use a tape recorder with the play back volume control, set it to fairly high level.
 - (2) Press the VERIFY button **6** while holding the TAPE MEMORY button down.
 - (3) Release the VERIFY button and the TAPE MEMORY button.
 - (4) Set the tape recorder to Play (playing mode).
Now playing back the data and verifying it start.
 - (5) If you hear the Pilot tone again, and the Tape Memory indicator is turned off and the indicators of the same Bank and Patch Number buttons light up as before verifying, Verify is completed. Stop the tape recorder.
- ★For reassurance, you may always verify after saving.

■ If there is an error . . . the indicators will be as shown below.

► Example When there is an error within the BANK C.

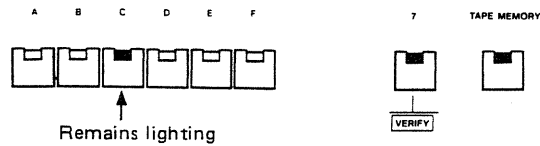

Repeat the Verify procedures taking care of following points.

- (1) Be sure to press the VERIFY button while the Pilot tone is still heard.
- (2) Be sure to adjust the play back level of the tape recorder.
- (3) Check if connections have been correctly made.
- (4) Check if the Bank you are trying to verify is the one you saved.

If there was an error in the very beginning of the Verify procedure, particularly take care of (1) and (4). If the Verify procedure did not complete even after fifteen seconds, (2) and (3) are particularly required.

If the above procedures were all correctly done, it is likely that there is something wrong with the tape itself.

- ★If the error is indicated again and again no matter how many times you try . . .
- Replace with a new tape.
 - Clean and demagnetize the head of the tape recorder.
 - Use a different tape recorder and repeat the same procedures.

★Preserving the data tape

Please do not keep the data recorded tape in a place of high temperature or humidity or near a strong magnetic unit such as a speaker or an amplifier.

(C) LOAD

- (1) Set the tape so that it will be played back from the very beginning of the data (where you hear a Pilot tone).
- (2) Set the MEMORY PROTECT switch on the rear panel of the JP-6 to OFF.
- (3) Hold the TAPE MEMORY button **11** down, and press the LOAD button **7**.
- (4) Release the LOAD button first, then the TAPE MEMORY button.
- (5) Set the tape recorder to Play (playing mode).
Now the loading starts.
- (6) If you hear the Pilot tone again, the Tape Memory indicator is turned off and the indicators of the same Bank and Patch Number buttons light up as before, Loading is completed. Stop the tape recorder. If you have loaded a Bank, it will be loaded in the same Bank as saved.

► Example

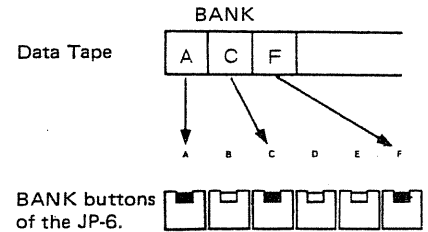

«Selecting the Bank where you are loading»

- (1) Set the tape so that it will be played back from the very beginning of the data (where you hear a Pilot tone).
- (2) Set the MEMORY PROTECT switch on the rear panel of the JP-6 to OFF.
- (3) Holding the TAPE MEMORY button **11** down, and press the LOAD button **7**.
- (4) Release the LOAD button first, then the TAPE MEMORY button.
- (5) Immediately after you release the TAPE MEMORY button, press the appropriate BANK button. You can choose more than one Bank, but not more than the Banks saved in the tape.
- (6) Set the tape recorder to Play. The data now will be loaded into the chosen Banks one by one in the priority order of A, B, C, D, E, F.

► Example 1.

When selecting BANKs A and D.

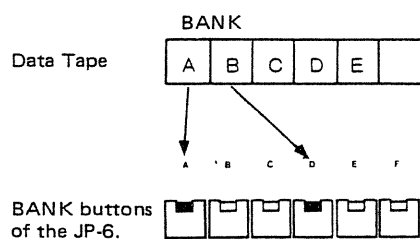

► Example 2

When selecting BANKs C, D, E, and F.

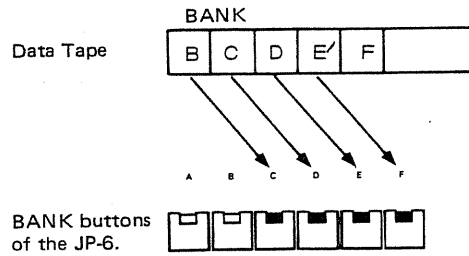

- (7) If you hear the Pilot tone again, and the Tape Memory indicator is turned off and the indicators of the same Bank and Patch Number buttons light up as before, stop the tape recorder.

«Selecting a Data Name»

- (1) Set the tape recorder so that the tape will start from just before the data you are going to load.
- (2) Set the MEMORY PROTECT switch to OFF.
- (3) Press the LOAD button ⑦ while holding the TAPE MEMORY button ⑪ down. Then without releasing the TAPE MEMORY button, select the Data Name you like.
- (4) Release the TAPE MEMORY button.
*If selecting a Bank here, follow the procedure (5) in the "Selecting a Bank".
- (5) Set the tape recorder to Play. When the tape proceeds up to the Data Name you have chosen, loading will start.

► Example

If selecting the Data Name F in loading.

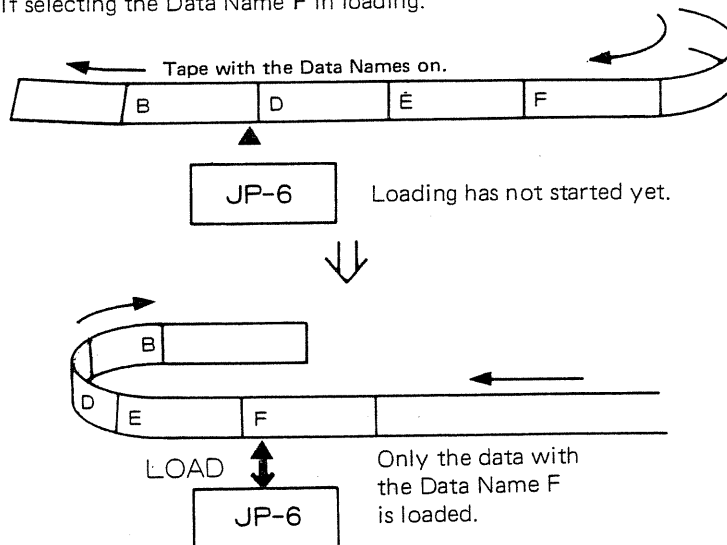

- (6) If you hear the Pilot tone again, and the Tape Memory indicator is turned off and the indicators of the same Bank and Patch Number buttons light up as before, stop the tape recorder.
- *Try using the good quality tape and tape recorder if dubbing the data from a cassette tape to another.

VII External Control

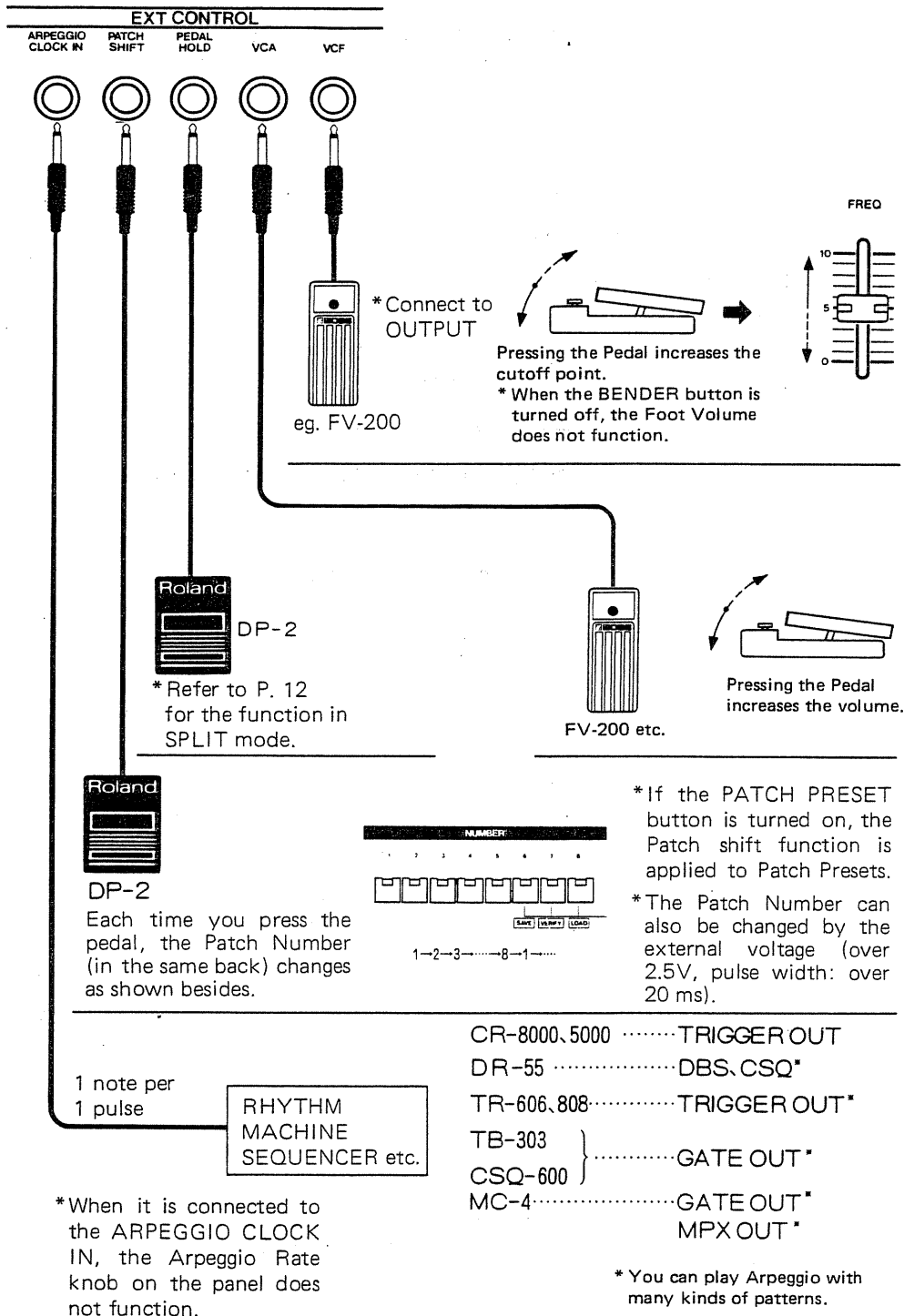

MIDI (Musical Instrument Digital Interface)

MIDI BUS is the interface system that converts the CV or Gate signal to the digital signal for the communication between two connected units. The information available in the JP-6 is as follows.

- (a) Key (which key is played)
- (b) Auto Tune
- (c) Patch Preset selection

* If the PATCH PRESET selector switch is turned off, information (c) cannot be exchanged.

* Although the JP-6 MIDI BUS sends all the information (a) to (c), some of this may not be received by the external device if the relevant functions are missing. For instance, if

the external device does not include the Auto Tune function, using the Auto Tune knob does not affect the external device at all. On the other hand, if the information other than (a) to (c) is sent to the JP-6, the JP-6 does not react at all.

VIII Arranging the Data

By using the Copy function and the Tape Memory function, you can change the order of the data previously written.

(A) Using the Copy function

- Copying a Patch Memory

There may be some Patch Memories which are more frequently used than others. If these Patch Memories are collected in the same Bank, it will be easier

to decide where to write a new patch, which after all saves a great deal of your work and time.

▶ Copying the Patch Memory B-3 into A-7.

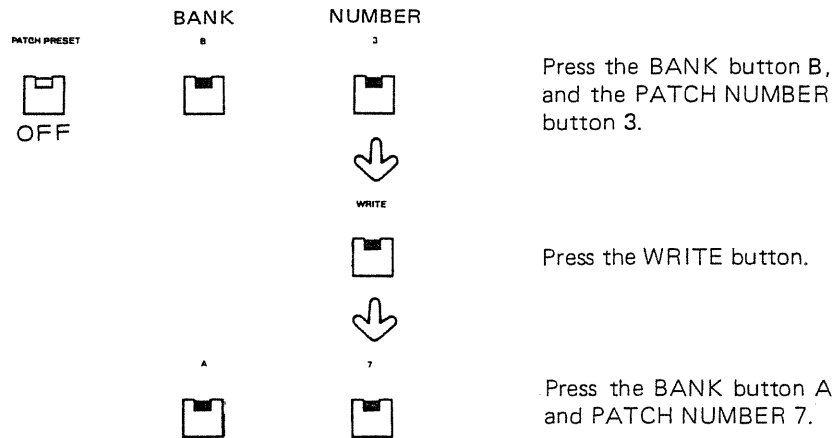

《NOTE》

Please be sure to press the BANK button first, then the PATCH NUMBER button. If you press the PATCH NUMBER button 7 first, the patch will be written into B-7.

*The color of the Memory Protect indicator (green or orange) will make this job a lot easier.

*This function is particularly useful when the Patch Shift function (see P. 33) is being used.

- Copying a Patch Preset

A Patch Preset can be copied and Patch Shifted.

► Copying the Patch Preset A-1 to C-6.

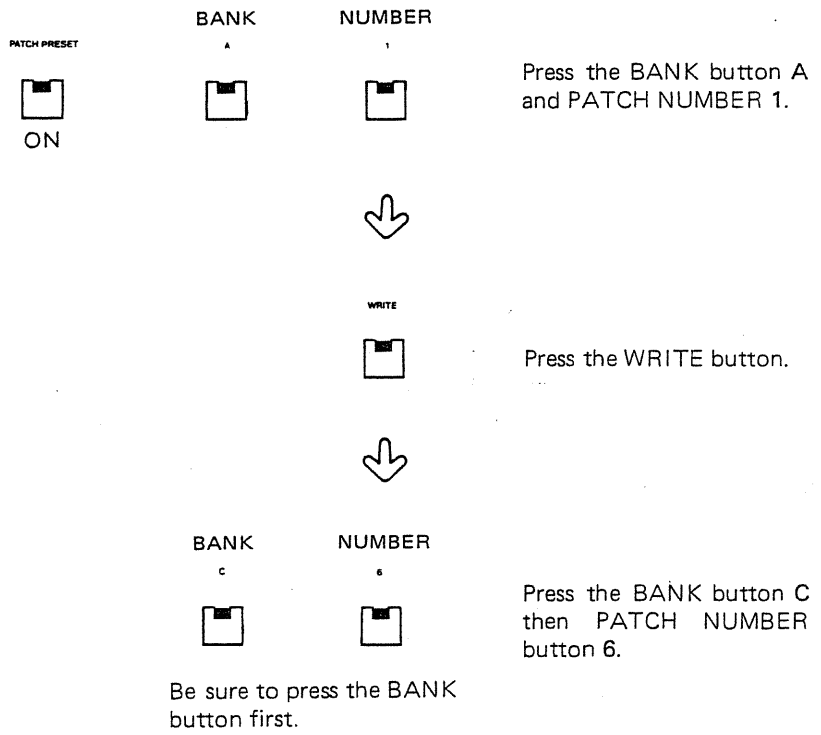

► Patch shift of the Patch Presets.

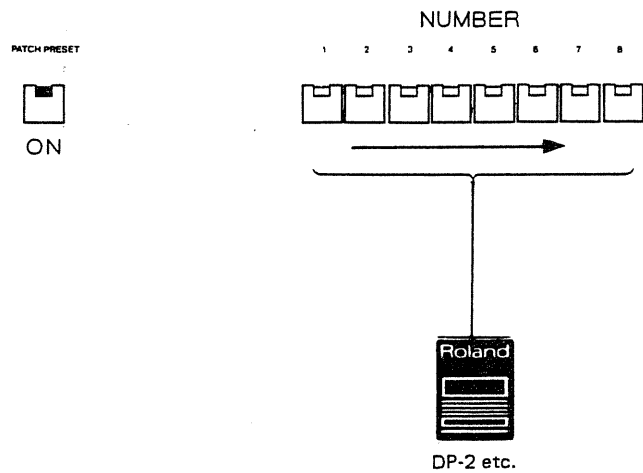

(B) Using the Tape Memory function

By saving and loading the Banks, it is possible to retain all the Patch Memories.

*Collecting the Patches you like into one Bank without erasing any Patch Memory.

► **Example** Arranging the Banks without erasing the existing data.

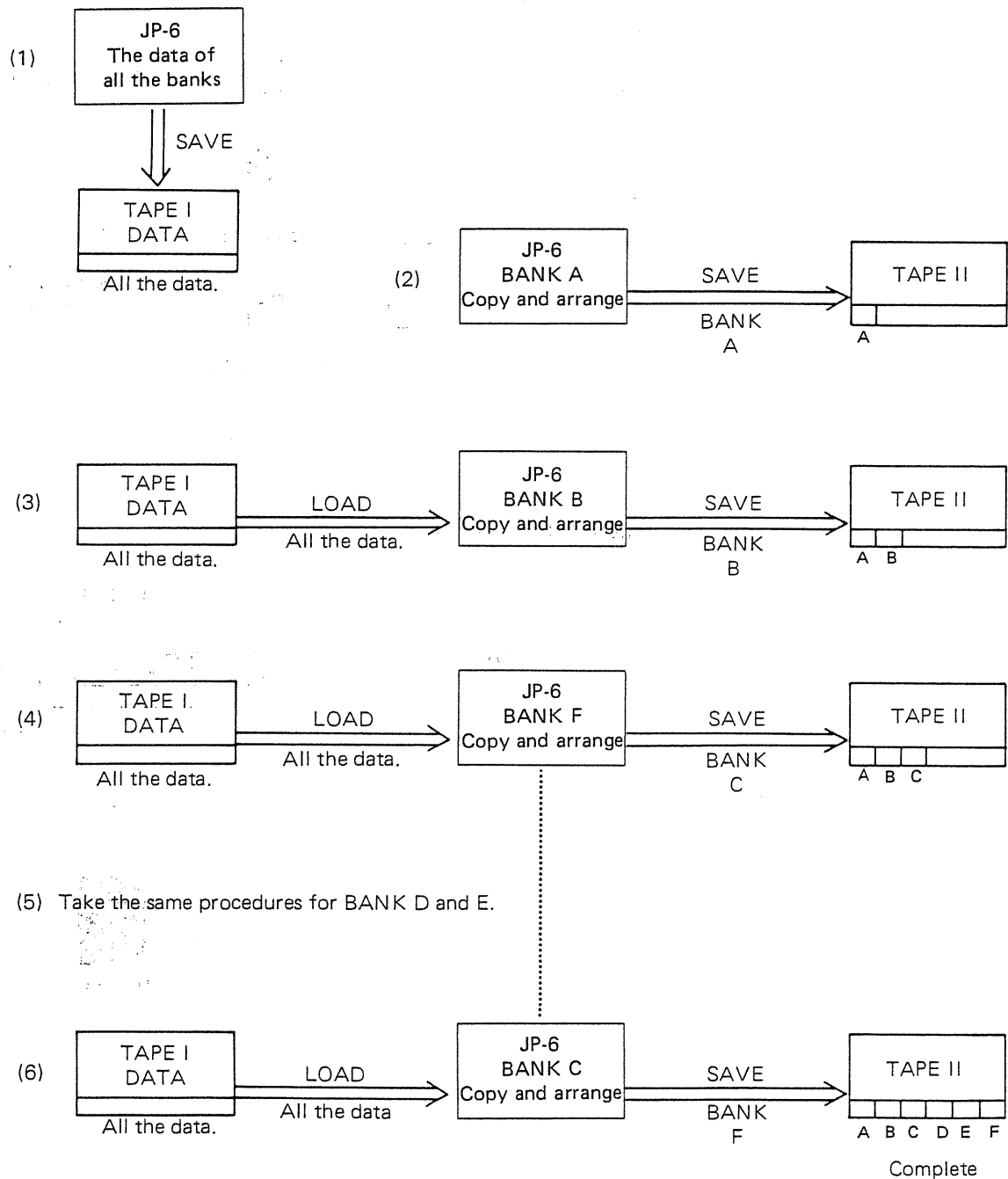

-
- (1) Save all the Patch Memories into the Tape I.
 - (2) Copy the Patches you like into Bank A, and save the whole Bank into the Tape II.
 - (3) Load the data of the Tape I into the JP-6, and copy some Patches you like into Bank B. Then save the whole data of Bank B into the Tape II. In this case, save it just after Bank A data.
 - (4) Load the data of the Tape I to the JP-6, and again select some patches you like and copy them into Bank C. Save the whole data of Bank C into the Tape I. Again be sure that it comes after Bank B data.
 - (5) Repeat the same procedure for Bank D and E.
 - (6) Load the data of the Tape I into the JP-6 and select the Patches you like and copy them into Bank F. Save the whole data of Bank F into the Tape II.

*Now you can use the data of the Tape II at any time you need by loading the Bank data separately into the JP-6.

*It is even more convenient to give a Data Name to each Bank data. For instance, you can give Data Name A to the Bank A data and Data Name B to the Bank B and so on. If you wish to load only the Bank B data, just assign the Data Name B, and play the tape from the beginning. Then only the Bank B data will be loaded. (If you choose the Data Name which is not saved in the tape, nothing will be loaded even though the tape is played up to the end.)













SPECIFICATIONS

- Jupiter-6
- 6 Voice Programmable Polyphonic Synthesizer

Keyboard 61 key, 5 Octaves: C-scale

VOLUME

Manual Section

VCO-1	WAVEFORM ( ,  ,  , ) RANGE (32' ~ 2' chromatic adjustment) CROSS MOD (ENV-1, MANUAL)
VCO-2	WAVEFORM ( ,  ,  , NOISE) RANGE (Low, 32' ~ 2' chromatic adjustment, High) High 2' ~ 0.5' or more Low 1.5Hz ~ 50Hz TUNE (± 50 cent)
SYNC	VCO-1 → VCO-2 VCO-2 → VCO-1
VCO MOD	LFO (10 oct.) ENV-1 (5 oct.) VCO MOD selector (VCO-1/VCO-2)
PWM	PW (50% ~ 0%) PWM PWM selector (ENV-1/LFO)
MIXER	SOURCE MIX (VCO-1, VCO-2)
VCF	Mode (LPF/24dB, HPF/24dB, BPF/12dB) CUTOFF FREQ (5Hz ~ 30kHz) RESONANCE ENV (10 oct. or more) ENV selector (ENV-1, ENV-2) LFO (10 oct. or more) KEY FOLLOW (0 ~ 120%)
VCA	ENV-2 LEVEL (Max. 60dB) LFO
ENV-1 (for VCO, VCF, PWM)	Attack Time (Max. 18s) Decay Time (Max. 20s) Sustain Level Release Time (Max. 20s) KEY FOLLOW (0 ~ 120%) POLARITY ( , )
ENV-2 (for VCF, VCA)	Attack Time (Max. 18s) Decay Time (Max. 20s) Sustain Level Release Time (Max. 20s) KEY FOLLOW (0 ~ 120%)
LFO-1	WAVEFORM ( ,  ,  , RANDOM) RATE (0.04 ~ 100Hz, RANDOM=0.04 ~ 400Hz) Delay Time (0 ~ 2s)

Memory Panel Section

Memory	Patch Presets (Bank 4 x Patch Number 8=32 Presets) Patch Memories (Bank 6 x Patch Number 8=48 Memories) MANUAL button WRITE button Memory Protect indicator
PANEL MODE	LOWER, UPPER
KEY MODE	SPLIT-1 (LOWER 4 notes, UPPER 2 notes) SPLIT-2 (LOWER 2 notes, UPPER 4 notes) WHOLE
ASSIGN	Mode (SOLO, UNISON, SOLO-UNISON, POLY-1, POLY-2) DETUNE (± 50 cent)
ARPEGGIO	RATE (1 ~ 25Hz) RANGE (1, 2, 3, 4 oct.) Mode (UP, DOWN, U & D, D & U)
GLIDE	TIME (0 ~ 1.6 sec/oct.) Mode (PORTAMENTO, GLISSANDO)
HOLD	HOLD button (ON/OFF)
BALANCE	UPPER/LOWER
BENDER	BENDER button (ON/OFF)
TAPE MEMORY	SAVE button VERIFY button LOAD button TAPE MEMORY button
TUNING	TUNE MASTER TUNE (± 50 cent)

Control Panel Section

BENDER	BENDER lever BEND selector (VCO-1, VCO-2) BEND WIDE (± 3 oct. or more) VCO SENS (± 1 oct.) VCF SENS (± 5 oct.)
LFO-2	MOD VCO SENS (± 100 cent or more) VCF SENS (± 4 oct.) RATE (1Hz ~ 10Hz) RISE TIME (50ms ~ 1 sec.)

Rear Panel

OUTPUT	1/4 Standard jack (level: 0/-15/-30 dBm) XLR Connector (imp: 600 Ω) Headphone jack (Stereo/8 Ω)
External Control	ARPEGGIO CLOCK IN (1 step/1 pulse = 2.5V or more) PATCH SHIFT (DP-2) PEDAL HOLD (DP-2) VCA CONTROL (-20dB, FV-200) VCF CONTROL (+2 oct. ~ -6 oct., FV-200)
TAPE MEMORY	MEMORY PROTECT (ON/OFF/ON) LOAD SAVE
MIDI	DIN Connector (OUT, IN)
POWER switch	
Power Consumption	30W
Dimension	1063(W) x 434(D) x 120(H)mm 41-7/8(W) x 17-1/16(D) x 4-3/4(H) in.
Weight	16 kg/35 lb. 4 oz.
Accessories	Power cable, Connecting cord

Options

- Headphone RH-10
- Aluminum Case TB-6



- Foot Volume FV-200
- Pedal Switch DP-2



MODEL JP-6 MIDI Implementation Chart

Function.....		Transmitted	Recognized	Remarks
Basic Channel	Default Changed	1, 2 ×	1, 2 ×	ver 1, 2 OLD MIDI
Mode	Default Messages Altered	3 OMNI OFF, POLY *****	1 OMNI ON/OFF, POLY MONO→OMNI ON	
Note Number	True voice	36-96 *****	0-127 36-96	
Velocity	Note ON Note OFF	× 9n v=64 fixed × 9n v=0	× ×	n=0 or 1
After Touch	Key's Ch's	× ×	× ×	
Pitch Bender		×	×	
Control Change		×	×	
Prog Change	True #	○ (0-31) *****	○ (0-31) 0-31	
System Exclusive		×	×	
System Common	Song Pos Song Sel Tune	× × ○	× × ○	
System Real Time	Clock Commands	× ×	× ×	
Aux Messages	Local ON/OFF All Notes OFF Active Sense Reset	× ○ (123) * × ×	× ○ (123-127) ** × ×	** ver 1,2 : 125-127 ver 3,4 : 123-127
Notes		When Power up, next mode messages are sent. ver 1,2 POLY ON ver 3,4 All Notes OFF, OMNI OFF, POLY ON * ver 1,2 : 127 ver 3 : 127, 124, 123 ver 4 : 123		

Mode 1 : OMNI ON, POLY
 Mode 3 : OMNI OFF, POLY

Mode 2 : OMNI ON, MONO
 Mode 4 : OMNI OFF, MONO

○ : Yes
 × : No

MODEL JP-6

MIDI Implementation

1. TRANSMITTED DATA

Status	Second	Third	Description
1001 0000	0kkk kkkk	0100 0000	Note on
1001 0001	0kkk kkkk	0100 0000	Note on (lower only) kkkkkkk = 36 - 96
1001 0000	0kkk kkkk	0000 0000	Note off
1001 0001	0kkk kkkk	0000 0000	Note off (lower only) kkkkkkk = 36 - 96
1100 0000	0ppp pppp		Program Change
1100 0001	0ppp pppp		Program Change ppppppp = 0 - 31
1011 0000	0111 1011	0000 0000	ALL NOTES OFF
1011 0001	0111 1011	0000 0000	ALL NOTES OFF (lower only)
1011 0000	0111 1100	0000 0000	OMNI OFF
1011 0001	0111 1100	0000 0000	OMNI OFF
1011 0000	0111 1111	0000 0000	POLY ON
1011 0001	0111 1111	0000 0000	POLY ON
1111 0110			Tune

notes:
 In WHOLE mode, the JP-6 sends messages in only channel 1.
 In SPLIT mode, channel 1 and 2 are allocated to the upper and lower half of the keyboard respectively.

When power is applied, following messages are sent.
 ch-1 ALL NOTES OFF, OMNI OFF, POLY ON

When PATCH PRESET button is pressed, following messages are sent.
 OFF messages for being ON notes,
 ch-1 (and ch-2) ALL NOTES OFF, OMNI OFF, POLY ON
 ch-1 (and ch-2) PROGRAM CHANGE,
 NOTE ON messages for being pressed notes.

When all notes turn OFF.

version	messages
3	ch-1 (or ch-2) ALL NOTES OFF, OMNI OFF, POLY ON
4	ch-1 (or ch-2) ALL NOTES OFF

2. RECOGNIZED RECEIVE DATA

When power is first applied, receiver's mode is OMNI ON, POLY mode.

Status	Second	Third	Description
1000 0000	0kkk kkkk	0vvv vvvv	Note OFF
1000 0001	0kkk kkkk	0vvv vvvv	Note OFF (lower only)
1000 nnnn	0kkk kkkk	0vvv vvvv	Note OFF (in OMNI mode) kkkkkkk = 0 - 127 (36 - 96) velocity ignored
1001 0000	0kkk kkkk	0000 0000	Note OFF
1001 0001	0kkk kkkk	0000 0000	Note OFF (lower only)
1001 nnnn	0kkk kkkk	0000 0000	Note OFF (in OMNI mode) kkkkkkk = 0 - 127 (36 - 96) velocity ignored
1001 0000	0kkk kkkk	0vvv vvvv	Note ON
1001 0001	0kkk kkkk	0vvv vvvv	Note ON (lower only)
1001 nnnn	0kkk kkkk	0vvv vvvv	Note ON (in OMNI mode) kkkkkkk = 0 - 127 (36 - 96) vvvvvvv = 1 - 127, velocity ignored
1100 0000	0ppp pppp		Program Change
1100 0001	0ppp pppp		Program Change
1100 nnnn	0ppp pppp		Program Change (in OMNI mode) ppppppp = 0 - 31
1011 0000	0111 1011	0000 0000	ALL NOTES OFF
1011 0001	0111 1011	0000 0000	ALL NOTES OFF (lower only)
1011 0000	0111 1100	0000 0000	OMNI OFF (ALL NOTES OFF)
1011 0001	0111 1100	0000 0000	OMNI OFF (ALL NOTES OFF)
1011 0000	0111 1101	0000 0000	OMNI ON (ALL NOTES OFF)
1011 0001	0111 1101	0000 0000	OMNI ON (ALL NOTES OFF)
1011 0000	0111 1110	0mmm mmmm	MONO ON (ALL NOTES OFF)
1011 0001	0111 1110	0mmm mmmm	MONO ON (ALL NOTES OFF)
1011 0000	0111 1111	0000 0000	POLY ON (ALL NOTES OFF)
1011 0001	0111 1111	0000 0000	POLY ON (ALL NOTES OFF)
1111 0110			Tune

Notes:
 Mode messages (123 - 127) are also recognized as ALL NOTES OFF.

Mode messages are recognized as follows:

	: POLY ON	: MONO ON
OMNI OFF (s7C)	: OMNI = OFF	: OMNI = ON *
	: POLY	: POLY
OMNI ON (s7D)	: OMNI = ON	: OMNI = ON
	: POLY	: POLY

* In this mode, only 'POLY ON' message can change to OMNI OFF.

Recognized channels defer to the KEY mode and MIDI mode, as follows:

KEY mode	MIDI mode	recognized channel number	
		voice messages	mode messages
WHOLE	POLY, OMNI OFF	ch-1	ch-1, ch-2
	POLY, OMNI ON	all channels	ch-1, ch-2
	MONO, OMNI OFF		
SPLIT	POLY, OMNI OFF	ch-1 for upper, ch-2 for lower	ch-1, ch-2
	POLY, OMNI ON	all ch for upper	ch-1, ch-2
	MONO, OMNI OFF		
	MONO, OMNI ON		

MODEL

JP-6

MIDI Implementation Chart

Function.....		Transmitted	Recognized	Remarks
Basic Channel	Default Changed	1, 2 *	1, 2 *	ver 1,2 : OLD MIDI (CH2 : Lower) * ver 1,2,3,4 : X 6 : O
Mode	Default Messages Altered	3 OMNI OFF, POLY *****	* OMNI ON/OFF, POLY MONO→OMNI ON	* ver 1,2,3,4 : Mode 1 6 : Mode 3
Note Number	True voice	36-96 *****	0-127 36-96	The Note Number message that gives less than 5 ms from Note ON to Note OFF cannot be received
Velocity	Note ON Note OFF	X 9n v=64 fixed X 9n v=0	X X	ver 1,2,3,4 : n=0or1 ver 6 : n changes depending on the channel setting
After Touch	Key's Ch's	X X	X X	
Pitch Bender		X	X	
Control Change		X	X	
Prog Change	True #	O (0-31) *****	O (0-31) 0-31	
System Exclusive		X	X	
System Common	Song Pos Song Sel Tune	X X O	X X O	
System Real Time	Clock Commands	X X	X X	
Aux Messages	Local ON/OFF All Notes OFF Active Sense Reset	X O (123) * X X	X O (123-127) ** X X	** ver 1,2 : 125-127 ...OLD MIDI ver 3, : 123-127 ver 4,6 : 123-127...MIDI 1.0
Notes		When Power up, next mode messages are sent. ver 1,2 POLY ON ver 3,4,6 All Notes OFF, OMNI OFF, POLY ON * ver 1,2 : 127 ver 3 : 127, 124, 123 ver 4,6 : 123		

Mode 1 : OMNI ON, POLY
Mode 2 : OMNI OFF, POLY

Mode 3 : OMNI ON, MONO
Mode 4 : OMNI OFF, MONO

O : Yes
X : No

MODEL JP-6 MIDI Implementation

1. TRANSMITTED DATA

Status	Second	Third	Description
1001 aaaa	Okkk kkkk	0100 0000	Note on
1001 bbbb	Okkk kkkk	0100 0000	Note on (lower only) kkkkkkk = 36 - 96
1001 aaaa	Okkk kkkk	0000 0000	Note off
1001 bbbb	Okkk kkkk	0000 0000	Note off (lower only) kkkkkkk = 36 - 96
1100 aaaa	Oppp pppp		Program Change
1100 bbbb	Oppp pppp		Program Change PPPPPPP = 0 - 31
1011 aaaa	0111 1011	0000 0000	ALL NOTES OFF
1011 bbbb	0111 1011	0000 0000	ALL NOTES OFF (lower only)
1011 aaaa	0111 1100	0000 0000	OMNI OFF
1011 bbbb	0111 1100	0000 0000	OMNI OFF
1011 aaaa	0111 1111	0000 0000	POLY ON
1011 bbbb	0111 1111	0000 0000	POLY ON
1111 0110			Tune

notes:

	version 3,4	version 6
aaaa	0000	MIDI channel - 1
bbbb	0001	aaaa + 1

if aaaa = 1111, then bbbb = 0000
When power is applied, aaaa = 0000

In following description, 'A' and 'B' represent aaaa + 1 and bbbb + 1 respectively.

In WHOLE mode, the JP-6 sends messages in only channel A.

In SPLIT mode, channel A and B are allocated to the upper and lower half of the keyboard respectively. Where A is aaaa + 1, B is bbbb + 1.

When power is applied, following messages are sent.
ch-1 ALL NOTES OFF, OMNI OFF, POLY ON

When MIDI channel is changed, following messages are sent. (version 6)
OFF messages for being ON notes,
Old ch-A (and ch-B) ALL NOTES OFF, OMNI OFF, POLY ON
New ch-A (and ch-B) ALL NOTES OFF, OMNI OFF, POLY ON
NOTE ON messages for being pressed notes.

When PATCH PRESET button is pressed, following messages are sent.
OFF messages for being ON notes,
ch-A (and ch-B) ALL NOTES OFF, OMNI OFF, POLY ON
ch-A (and ch-B) PROGRAM CHANGE,
NOTE ON messages for being pressed notes.

When all notes turn OFF.

Version	Messages transmitted
3	ch-A (or ch-B) ALL NOTES OFF, OMNI OFF, POLY ON
4,6	ch-A (or ch-B) ALL NOTES OFF

2. RECOGNIZED RECEIVE DATA

When power is first applied, receiver's mode is set as follows:

Version	Mode
3,4	OMNI ON, POLY
6	OMNI OFF, POLY

(While 'TUNE' button is pressed.)

When MIDI channel is changed, the OMNI mode will be turned OFF.

Status	Second	Third	Description
1000 aaaa	Okkk kkkk	Ovvv vvvv	Note OFF
1000 bbbb	Okkk kkkk	Ovvv vvvv	Note OFF (lower only)
1000 nnnn	Okkk kkkk	Ovvv vvvv	Note OFF (in OMNI mode) kkkkkkk = 0 - 127 (36 - 96) velocity ignored
1001 aaaa	Okkk kkkk	0000 0000	Note OFF
1001 bbbb	Okkk kkkk	0000 0000	Note OFF (lower only)
1001 nnnn	Okkk kkkk	0000 0000	Note OFF (in OMNI mode) kkkkkkk = 0 - 127 (36 - 96) velocity ignored
1001 aaaa	Okkk kkkk	Ovvv vvvv	Note ON
1001 bbbb	Okkk kkkk	Ovvv vvvv	Note ON (lower only)
1001 nnnn	Okkk kkkk	Ovvv vvvv	Note ON (in OMNI mode) kkkkkkk = 0 - 127 (36 - 96) velocity ignored
1100 aaaa	Oppp pppp		Program Change
1100 bbbb	Oppp pppp		Program Change
1100 nnnn	Oppp pppp		Program Change (in OMNI mode) ppppppp = 0 - 31
1011 aaaa	0111 1011	0000 0000	ALL NOTES OFF
1011 bbbb	0111 1011	0000 0000	ALL NOTES OFF (lower only)
1011 aaaa	0111 1100	0000 0000	OMNI OFF (ALL NOTES OFF)
1011 bbbb	0111 1100	0000 0000	OMNI OFF (ALL NOTES OFF)
1011 aaaa	0111 1101	0000 0000	OMNI ON (ALL NOTES OFF)
1011 bbbb	0111 1101	0000 0000	OMNI ON (ALL NOTES OFF)
1011 aaaa	0111 1110	0000 mmmm	MONO ON (ALL NOTES OFF)
1011 bbbb	0111 1110	0000 mmmm	MONO ON (ALL NOTES OFF)
1011 aaaa	0111 1111	0000 0000	POLY ON (ALL NOTES OFF)
1011 bbbb	0111 1111	0000 0000	POLY ON (ALL NOTES OFF)
1111 0110			Tune

Notes:

	version 3,4	version 6
aaaa	0000	MIDI channel - 1
bbbb	0001	aaaa + 1

if aaaa = 1111, then bbbb = 0000
When power is applied, aaaa = 0000

nnnn : 0000 - 1111

In following description, 'A' and 'B' represent aaaa + 1 and bbbb + 1 respectively.

Mode messages (123 - 127) are also recognized as ALL NOTES OFF.

Mode messages are recognized as follows:

	POLY ON	MONO ON
OMNI OFF (\$7C)	OMNI = OFF	OMNI = ON *
	POLY	POLY
OMNI ON (\$7D)	OMNI = ON	OMNI = ON
	POLY	POLY

* In this mode, only 'POLY ON' message can change to OMNI OFF.

Recognized channels defer to the KEY mode and MIDI mode, as follows:

KEY mode	MIDI mode	recognized channel number	voice messages	mode messages
WHOLE	POLY, OMNI OFF	ch-A	ch-A	ch-A, ch-B
	POLY, OMNI ON	all channels	ch-A	ch-A, ch-B
	MONO, OMNI OFF			
SPLIT	POLY, OMNI OFF	ch-A for upper, ch-B for lower	ch-A	ch-A, ch-B
	POLY, OMNI ON	all ch for upper	ch-A	ch-A, ch-B
	MONO, OMNI OFF			
	MONO, OMNI ON			

 Roland®

10172

UPC 10172



18981