 **BOSS**®

KM-6B

Mixer

INSTRUCTIONS

- Please read these instructions carefully for proper operating procedures for the BOSS KM-6B.

■ PANEL PARTS – NAME AND FUNCTION

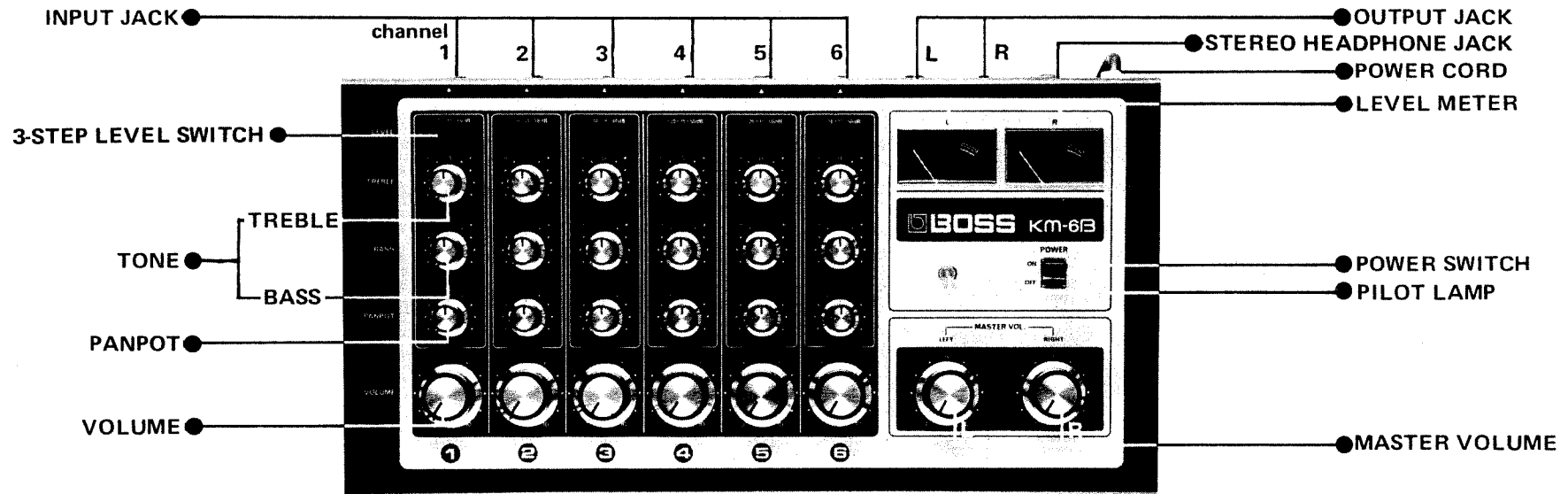

- **INPUT JACK** receives microphone and instrument for mixing.
- **OUTPUT JACK** connects mixed signal to separate right and left amplifiers, echo chamber, and others.
- **LEVEL SWITCH** changes input level to three steps to accord with the input device (-20/-35/-50dB). Set to -50dB for microphone, -35dB for guitar, etc. and -20dB for synthesizer.
- **TONE CONTROL** adjusts the level of treble and bass according to the instrument connected to each input jack.
TREBLE: Normal tone with knob at "0" graduation. Turn knob clockwise (↻) from "0" to intensify treble, and

- counterclockwise (↺) to de-emphasize treble.
- BASS:** Normal tone with knob at "0" graduation. Turn knob clockwise (↻) from "0" to intensify bass, and counterclockwise (↺) to de-emphasize bass.
- **PANPOT** determines the distribution of each input source in the mixed outputs. When PANPOT of an input channel is set to CENTER, the corresponding input is produced both from right and left outputs equally. When PANPOT is gradually turned clockwise (↻), the sound of the input channel gradually moves to the right output. When PANPOT is gradually

- turned counterclockwise (↺), sound of the input channel gradually moves to the left output.
- **MASTER VOLUME** controls level of mixed signal of R and L output separately.
RIGHT controls level of RIGHT output. When the knob is turned clockwise (↻), the level is increased, and counterclockwise (↺), the level is decreased.
LEFT controls level of LEFT output. When the knob is turned clockwise (↻), the level is increased, and counterclockwise (↺), the level is decreased.
- **VOLUME** (channel 1 – channel 6) controls the level of each input channel. To bring out any instrument or vocal sound during

- performance, turn the knob of corresponding channel clockwise (↻). To de-emphasize, turn knob counterclockwise (↺).
- **LEVEL METER** is a stereophonic VU meter that indicates the level of both output channels. If the meter pointer goes into the plus range (red section), the sound may be distorted. Best quality sound is obtained at the border of green and red section (0dB point), where the output level is -0dB.
- **STEREO HEADPHONE JACK**
- **POWER SWITCH**
- **POWER PILOT LAMP** lights up when power is switched on.

BEFORE USING KM-6B

- KM-6B operates on AC mains. It may heat up slightly, but that is not a sign of trouble.
- While not in use, set POWER switch to OFF.
- Avoid using KM-6B in very dusty location, or under high temperature or humidity conditions.

■ CONNECTING KM-6B

● TO STEREO SOUND PRODUCER

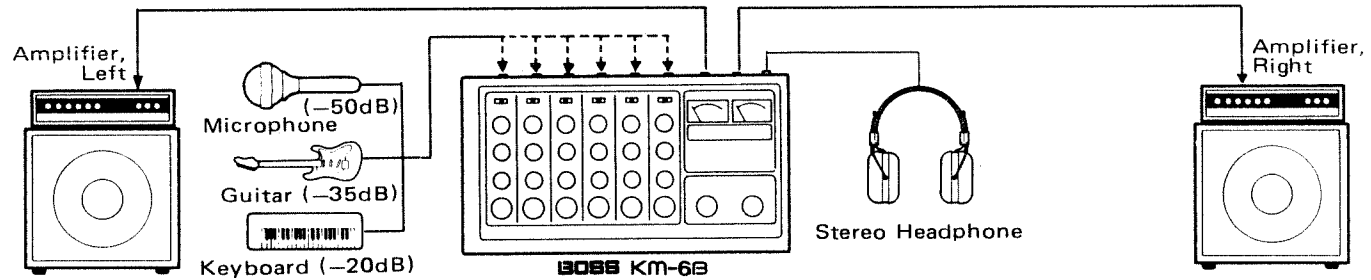

● TO GRAPHIC EQUALIZER

For stereophonic application, use two graphic equalizers (BOSS GE-10).

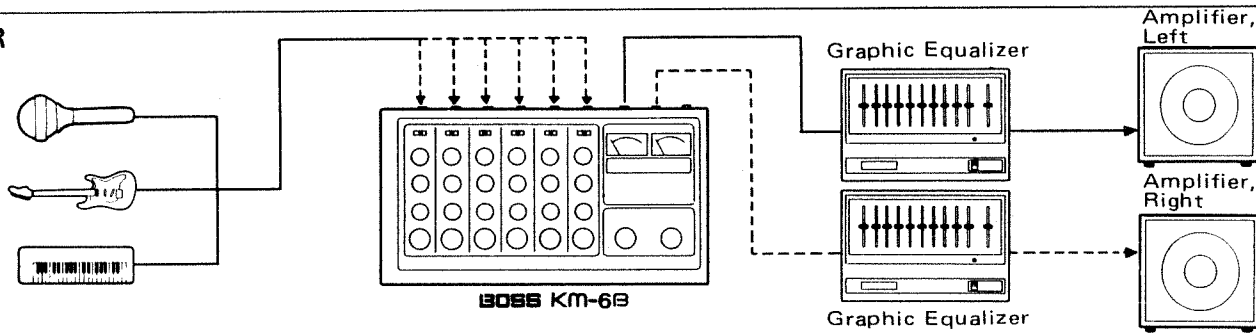

● TO ECHO CHAMBER IN MULTIPERFORMANCE

One channel produces echo effect and the other, unmodified sound.

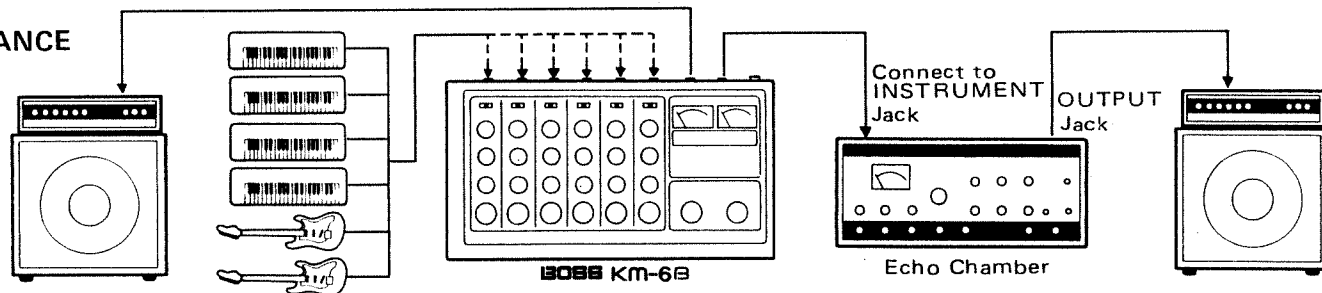

■ GOING INTO ACTION

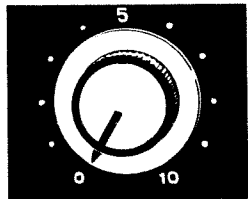

1 After completing all cord connections, set all knobs on the panel to zero (0) position.

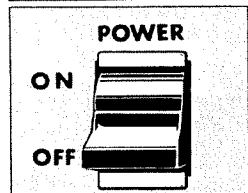

2 Make sure that POWER switch is set to OFF, and plug power cord into outlet.

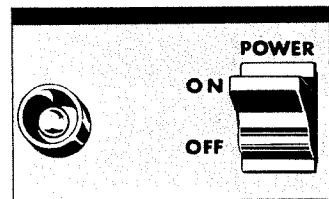

3 KM-6B is ready to produce mixed sound.

4 Set POWER switch to ON, and power pilot lamp and level meter lamp will light up.

5 Set level switches to proper position.

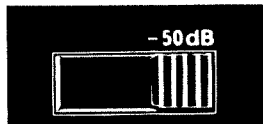

◀ To -50dB when connecting microphone.

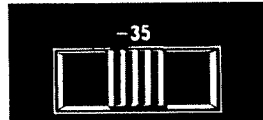

◀ To -35dB when connecting electric guitar, etc.

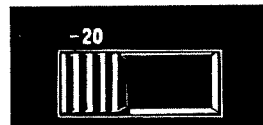

◀ To -20dB when connecting synthesizer, etc.

6 Set PANPOT to proper position to obtain maximal mixing results.

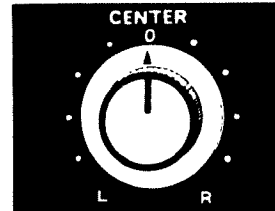

▲ To R for sound from right channel only.

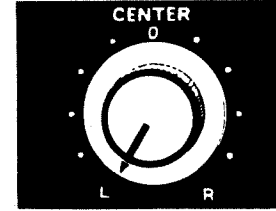

▲ To CENTER for sound from both channel outputs.

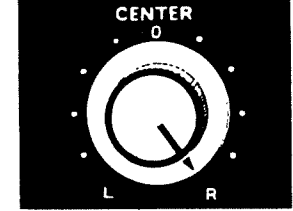

▲ To L for sound from left channel only.

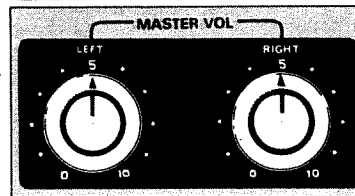

7 Set both L and R MASTER VOLUME to "5" graduation.

8 Set each input channel volume to proper position. Turn the knob to clockwise (↻) to intensify given instrument, and counterclockwise (↺) to de-emphasize.

- When connecting three or more instruments, adjust each channel volume to proper position and then readjust R and L MASTER VOLUME.
- VOLUME of channel not in use should be set to zero (0) position.

9 Move tone controls, TREBLE and BASS knobs of each channel to proper position to produce optimum sound.

10 Level meter indicates sound level of R and L outputs. If the pointer goes up into the plus range (red section), the sound may be distorted. In that case reduce the volume of each input channel or master volume. The best sound is produced at the border of green and red sections.

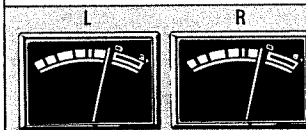

- If the sound is distorted even when total sound level is reduced with MASTER VOLUME, readjust volume of each channel separately.

HIGH OPERABILITY WITH INCLINED INSTALLATION

KM-6B is provided with side angles on both sides of the body, to make it possible to mount on a standard 19-inch rack. Furthermore simply by changing the position of two screws, each on the right and left sides, the unit can be used in an inclined posture to enhance the operability.

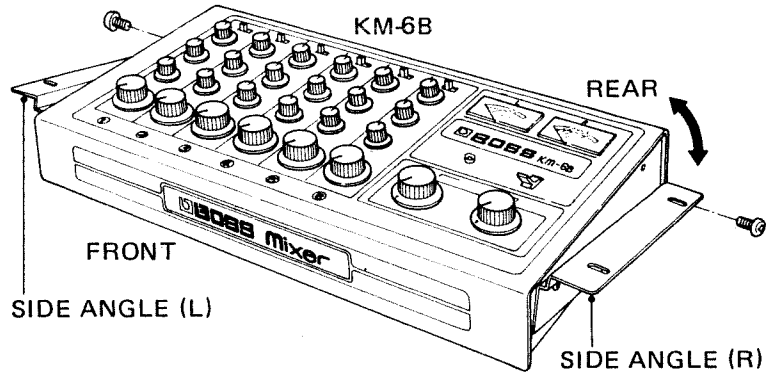

MOUNTING METHOD

1. INCLINED MOUNTING

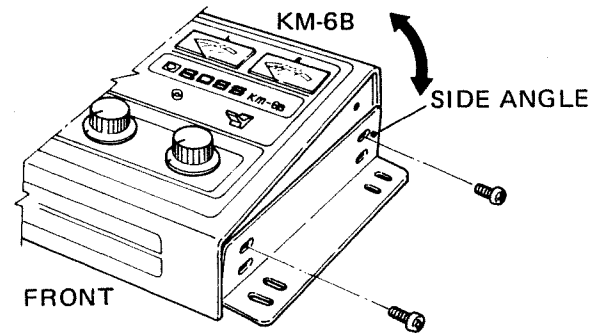

2. WITH SIDE ANGLE FACING OUTSIDE

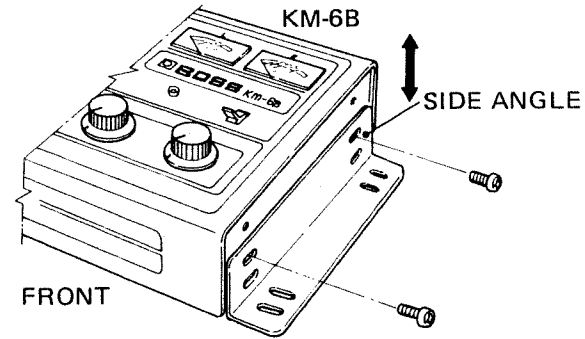

3. WITH SIDE ANGLE FACING INSIDE

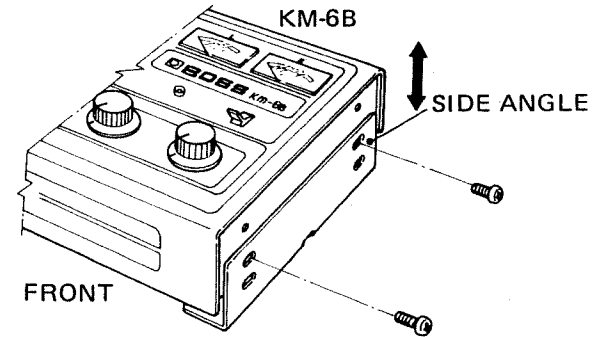

■ KM-6B MAJOR SPECIFICATIONS

Power consumption:	4W
Input sensitivity:	-50dB/-35dB/-20dB (3.1mV/18mV/100mV)
Input impedance:	3.9k (-50dB) 33k (-35dB, -20dB)
Output level:	0dB (1V)
S/N ratio:	Over 70dB
Control:	Channel volume control 6 Treble tone control 6 Bass tone control 6 Panpot 6 Level switch (-50dB/-35dB/-20dB). 6 Power switch 1
Main control:	Master volume (LEFT/RIGHT) 2
Output:	LEFT/RIGHT 2 Stereo headphone jack (Imp. 8Ω) 1
Semiconductors:	14 IC's 6 transistors 8 diodes 1 LED
Dimensions:	480(width) x 85(height) x 220(depth)mm
Weight:	3.8kg

■ Specifications are subject to change without prior notice.

■ BLOCK DIAGRAM

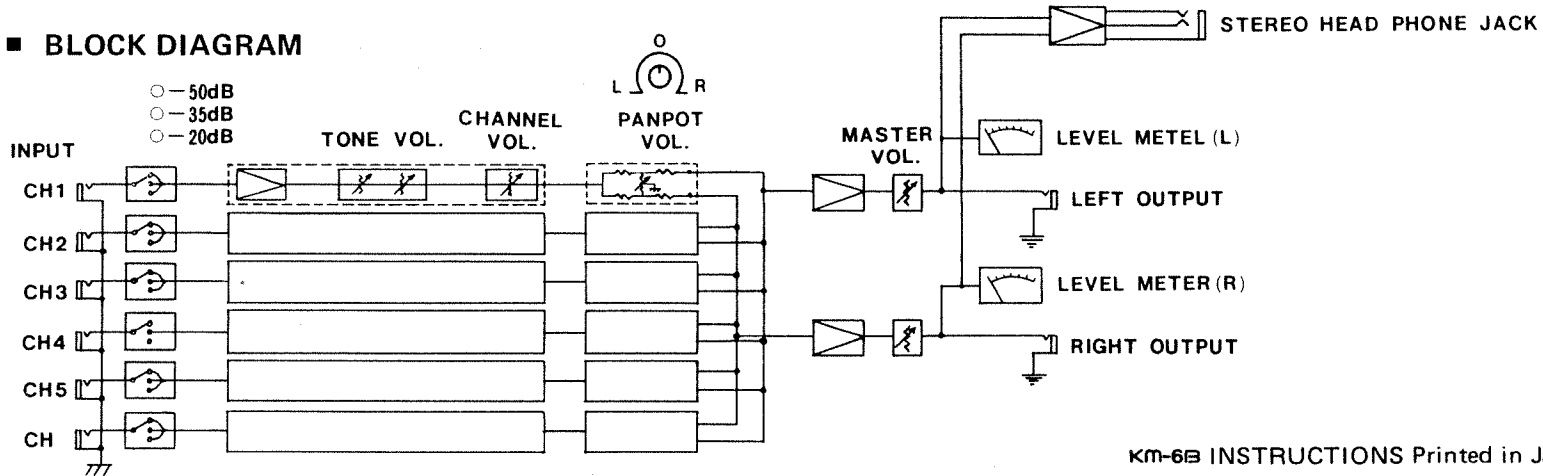

 Roland®

10176

UPC 10176



10176

 **BOSS**