

Roland®





DIGITAL INTELLIGENT PIANO

---

# KR-770

Owner's Manual

Before using this unit, carefully read the sections entitled: "IMPORTANT SAFETY INSTRUCTIONS" (p. 2), "USING THE UNIT SAFELY" (p. 3), and "IMPORTANT NOTES" (p. 7). These sections provide important information concerning the proper operation of the unit. Additionally, in order to feel assured that you have gained a good grasp of every feature provided by your new unit, this manual should be read in its entirety. The manual should be saved and kept on hand as a convenient reference.

	<b>CAUTION</b> RISK OF ELECTRIC SHOCK DO NOT OPEN	
<b>ATTENTION:</b> RISQUE DE CHOC ELECTRIQUE NE PAS OUVRI		
<b>CAUTION:</b> TO REDUCE THE RISK OF ELECTRIC SHOCK, DO NOT REMOVE COVER (OR BACK). NO USER-SERVICEABLE PARTS INSIDE. REFER SERVICING TO QUALIFIED SERVICE PERSONNEL.		



The lightning flash with arrowhead symbol, within an equilateral triangle, is intended to alert the user to the presence of uninsulated "dangerous voltage" within the product's enclosure that may be of sufficient magnitude to constitute a risk of electric shock to persons.



The exclamation point within an equilateral triangle is intended to alert the user to the presence of important operating and maintenance (servicing) instructions in the literature accompanying the product.

INSTRUCTIONS PERTAINING TO A RISK OF FIRE, ELECTRIC SHOCK, OR INJURY TO PERSONS.

## IMPORTANT SAFETY INSTRUCTIONS

### SAVE THESE INSTRUCTIONS

**WARNING** - When using electric products, basic precautions should always be followed, including the following:

1. Read all the instructions before using the product.
2. Do not use this product near water — for example, near a bathtub, washbowl, kitchen sink, in a wet basement, or near a swimming pool, or the like.
3. This product should be used only with a cart or stand that is recommended by the manufacturer.
4. This product, either alone or in combination with an amplifier and headphones or speakers, may be capable of producing sound levels that could cause permanent hearing loss. Do not operate for a long period of time at a high volume level or at a level that is uncomfortable. If you experience any hearing loss or ringing in the ears, you should consult an audiologist.
5. The product should be located so that its location or position does not interfere with its proper ventilation.
6. The product should be located away from heat sources such as radiators, heat registers, or other products that produce heat.
7. The product should be connected to a power supply only of the type described in the operating instructions or as marked on the product.
8. The power-supply cord of the product should be unplugged from the outlet when left unused for a long period of time.
9. Care should be taken so that objects do not fall and liquids are not spilled into the enclosure through openings.
10. The product should be serviced by qualified service personnel when:
  - A. The power-supply cord or the plug has been damaged; or
  - B. Objects have fallen, or liquid has been spilled onto the product; or
  - C. The product has been exposed to rain; or
  - D. The product does not appear to operate normally or exhibits a marked change in performance; or
  - E. The product has been dropped, or the enclosure damaged.
11. Do not attempt to service the product beyond that described in the user-maintenance instructions. All other servicing should be referred to qualified service personnel.

**For the USA**

This product may be equipped with a polarized line plug (one blade wider than the other) . This is a safety feature. If you are unable to insert the plug into the outlet, contact an electrician to replace your obsolete outlet. Do not defeat the safety purpose of the plug.

**For Canada**

For Polarized Line Plug

**CAUTION:** TO PREVENT ELECTRIC SHOCK, MATCH WIDE BLADE OF PLUG TO WIDE SLOT, FULLY INSERT.  
**ATTENTION:** POUR ÉVITER LES CHOCs ÉLECTRIQUES, INTRODUIRE LA LAME LA PLUS LARGE DE LA FICHE DANS LA BORNE CORRESPONDANTE DE LA PRISE ET POUSSER JUSQU' AU FOND.

**For the U.K.**

**IMPORTANT:** THE WIRES IN THIS MAINS LEAD ARE COLOURED IN ACCORDANCE WITH THE FOLLOWING CODE.

BLUE: NEUTRAL  
 BROWN: LIVE

As the colours of the wires in the mains lead of this apparatus may not correspond with the coloured markings identifying the terminals in your plug, proceed as follows:  
 The wire which is coloured BLUE must be connected to the terminal which is marked with the letter N or coloured BLACK.  
 The wire which is coloured BROWN must be connected to the terminal which is marked with the letter L or coloured RED.  
 Under no circumstances must either of the above wires be connected to the earth terminal of a three pin plug.

# USING THE UNIT SAFELY

## INSTRUCTIONS FOR THE PREVENTION OF FIRE, ELECTRIC SHOCK, OR INJURY TO PERSONS

### About ⚠ WARNING and ⚠ CAUTION Notices

<b>⚠ WARNING</b>	Used for instructions intended to alert the user to the risk of death or severe injury should the unit be used improperly.
<b>⚠ CAUTION</b>	Used for instructions intended to alert the user to the risk of injury or material damage should the unit be used improperly. * Material damage refers to damage or other adverse effects caused with respect to the home and all its furnishings, as well to domestic animals or pets.

### About the Symbols

	The ⚠ symbol alerts the user to important instructions or warnings. The specific meaning of the symbol is determined by the design contained within the triangle. In the case of the symbol at left, it is used for general cautions, warnings, or alerts to danger.
	The ⓧ symbol alerts the user to items that must never be carried out (are forbidden). The specific thing that must not be done is indicated by the design contained within the circle. In the case of the symbol at left, it means that the unit must never be disassembled.
	The ⚡ symbol alerts the user to things that must be carried out. The specific thing that must be done is indicated by the design contained within the circle. In the case of the symbol at left, it means that the power-cord plug must be unplugged from the outlet.

### ALWAYS OBSERVE THE FOLLOWING

#### ⚠ WARNING

- Before using this unit, make sure to read the instructions below, and the Owner's Manual.
- Do not open or perform any internal modifications on the unit.
- Avoid damaging the power cord. Do not bend it excessively, step on it, place heavy objects on it, etc. A damaged cord can easily become a shock or fire hazard. Never use a power cord after it has been damaged.
- In households with small children, an adult should provide supervision until the child is capable of following all the rules essential for the safe operation of the unit.
- Protect the unit from strong impact. (Do not drop it!)
- Do not force the unit's power-supply cord to share an outlet with an unreasonable number of other devices. Be especially careful when using extension cords—the total power used by all devices you have connected to the extension cord's outlet must never exceed the power rating (watts/amperes) for the extension cord. Excessive loads can cause the insulation on the cord to heat up and eventually melt through.
- Before using the unit in a foreign country, consult with your dealer, or qualified Roland service personnel.

#### ⚠ CAUTION

- Always grasp only the plug on the power-supply cord when plugging into, or unplugging from, an outlet or this unit.
- Try to prevent cords and cables from becoming entangled. Also, all cords and cables should be placed so they are out of the reach of children.
- Never climb on top of, nor place heavy objects on the unit.
- Never handle the power cord or its plugs with wet hands when plugging into, or unplugging from, an outlet or this unit.
- If you need to move the instrument, take note of the precautions listed below. At least two persons are required to safely lift and move the unit. It should be handled carefully, all the while keeping it level. Make sure to have a firm grip, to protect yourself from injury and the instrument from damage.
  - Disconnect the power cord.
  - Raise the adjuster at the bottom of the pedal.
  - Close the lid.
  - Fold down the music stand.
- Before cleaning the unit, turn off the power and unplug the power cord from the outlet (p.7).
- Whenever you suspect the possibility of lightning in your area, pull the plug on the power cord out of the outlet.
- Be careful when opening/closing the lid so you do not get your fingers pinched (p.9). Adult supervision is recommended whenever small children use the unit.

# Introduction

We'd like to take a moment to thank you for purchasing the Roland KR-770 Digital Piano. With the KR-770's easy-to-operate keyboard and automatic accompaniment, you will find it truly enjoyable to play. In order to enjoy reliable performance for many years to come, please take the time to read this manual in its entirety.

## Main Features

### One Touch Program That Prepares for Play Instantly at the Touch of a Button

Piano button for Piano play settings  
Organ button for Organ play settings  
Arranger button for Style Play settings

### Up to 300 Types of Tones and 120 Types of Styles Built In

Support for a wide range of musical genres  
Expanded number of Styles on the included Style disk

### Piano Tones with Stereo Sampling and Digital Effects

Re-creates the sounds of a high-quality concert grand piano

### Hammer-action Keyboard

Realistic piano performances are possible

### Ample 64 Voices

Up to 64 voices can be played simultaneously

### A Simple Yet Versatile Composer Is Built In

Simple recording  
Playback of commercial music data  
A wide-ranging Composer menu

- 16 Track Sequencer
- Chord Sequencer
- Song Edit
- Style Composer
- Style Converter

### Microphone Input Jack

Equipped with an echo adjustment function



### General MIDI System

The General MIDI System is a set of recommendations which seeks to standardize the MIDI support features of sound generating devices. Sound generating devices and musical data (disks) carrying the General MIDI logo conform to the General MIDI specifications. This means that whenever you play music data marked with the General MIDI logo, the musical response will be identical when played on any device which also carries the General MIDI logo.



### GS Format

Roland developed the GS Format to standardize the response of sound generators when MIDI is used for the production of music. By using a GS Format sound generating device, you can be assured that you will always obtain a faithful, high-quality rendition of any commercially available music data that carries the GS Format logo.

The KR-770's sound generator fully supports both the General MIDI system and the GS Format—so you can use music data that is designed for either standard.



### SMF Music Data

The KR-770 is capable of playing Standard MIDI Files, such as "SMF Music Data" (720 KB/1.44 MB format 3.5 inch floppy disks).

Copyright © 1996 ROLAND CORPORATION

All rights reserved. No part of this publication may be reproduced in any form without the written permission of ROLAND CORPORATION.

# Contents

	Introduction .....	4
	Important Notes .....	7
	Before Using the Unit .....	9
	Panel Descriptions.....	12
	Basic Operation and How to Read the Display .....	16
<b>Chapter 1</b>	<b>1. Overview of the KR-770</b>	
<b>Quick-Start</b>	An Introduction to the Functions—[Demo] Button .....	17
	<b>2. The KR-770's Performance Functions</b>	
	One Touch Program	
	Let's Try a Piano Performance—The One Touch Program [Piano] Button.....	19
	Let's Turn On the Metronome .....	19
	Let's Use the Pedal.....	20
	Let's Try an Organ Performance—The One Touch Program [Organ] Button.....	20
	Let's Try Playing a Style—The One Touch Program [Arranger] Button.....	21
	Let's Play "When the Saints Go Marching In" .....	22
	Let's Try Some Drum Sounds and Effects—The [Drums/SFX] Button.....	24
	Let's Listen to Some Music Data—Playing Back Disk Performances.....	24
	Let's Sing Using the Microphone.....	26
<b>Chapter 2</b>	<b>1. Tones</b>	
	Selecting Tones .....	27
	Adding Effects to Tones .....	28
	Adding Reverberation to the Tone—The [Reverb] Slider.....	28
	Adding Various Effects to Tones—DSP Effect .....	28
	Adding Breadth to Tones—Chorus Effect.....	28
	Changing the Sound's Pitch by Octaves—Octave Shift .....	29
	Playing Using One Tone for the Entire Keyboard—Whole Keyboard Play.....	29
	Playing With Different Tones in the Left and Right Hand—Split Play .....	30
	Sounding Two Layered Tones—Layer Play.....	31
	<b>2. Style Play</b>	
	Settings for Playing in Style Play .....	32
	Selecting Styles .....	33
	Starting and Stopping Styles .....	33
	Adjusting the Tempo of a Style.....	36
	Adjusting Accompaniment and Melody Volume Balance—The [Balance] Slider .....	36
	Switching Style Arrangements.....	36
	Arrangement Type.....	36
	Accompaniment Pattern Type .....	37
	Easy Fingering for Chords—Chord Intelligence .....	38
	Using Style Disks.....	39
	Adding Harmony to the Melody—The [Melody Intelligence] Button.....	40
	Adjusting the Volume of Each Part—The Part Volume Buttons .....	41
	<b>3. Recording and Playback</b>	
	Recording Performances (Normal Recording).....	42
	Playing Back Recorded Performances.....	44
	Erasing Recorded Performances .....	46
	Saving Recorded Performances to Disk—Save.....	46
	Saving After Converting Data to SMF Format.....	47
	Saving User Styles .....	48

<b>Chapter 3</b>	<b>1. Composer Menu</b>	
	Operating of the Composer Menu .....	49
	Recording Multiple Voices—16 Track Sequencer .....	49
	Using the Chord Sequencer Function .....	50
	Changing the Recording Method—Recording Mode .....	51
	Using New Disks—Formatting .....	51
	Using Built-in Styles to Create Your Own Style—Style Composer .....	52
	Creating an Original Style—Style Converter .....	53
	Editing a Recorded Performance—Song Edit .....	54
	<b>2. Function Menu</b>	
	Operating Procedure for the Function Menu .....	58
	● Piano Screen Functions .....	58
	Changing the Metronome Volume and Beat .....	58
	Changing the Touch of the Keys .....	58
	Changing the Keyboard's Tuning—Tuning .....	59
	Repeatedly Playing Back the Same Section—The Marker Function .....	59
	● Organ Screen Functions .....	60
	Using the Arranger Function .....	60
	Turning the Lower Tone On and Off/Changing the Split Point .....	60
	● Basic Screen Functions .....	61
	Changing Arranger Settings .....	61
	Changing Chord Tone and Bass Tone .....	61
	<b>3. Registering Panel Settings and/or Performance Function</b>	
	Registering Panel Settings—User Program .....	62
	Saving User Programs to Disk .....	62
	Registering Program Functions—The Pad Buttons .....	63
	Changing How the Pedals Work .....	64
	<b>4. Utility Menu</b>	
	Operating Procedure for the Utility Menu .....	65
	Adjusting the Pitch—Master Tuning .....	65
	Changing the Keyboard Touch/Changing the Key—Transpose .....	65
	Changing the Volume and Beat of the Metronome .....	66
	Changing the Type of Reverb or Chorus Effect .....	66
	Choosing an Expansion Tone .....	67
	Adjusting the Contrast of the Display .....	67
	Switching Off the Display of Lyrics .....	67
	Setting the Bend Range .....	67
	Using MIDI to Change Tone on an External Instrument—Send Program Change .....	67
	Changing the MIDI Send Channel/Setting MIDI Local Control .....	68
	Arranger Update for User Programs .....	68
	Memory Backup .....	69
	Returning to the Initial Settings—Factory Preset .....	69
	Linking the Keyboard Performance Data and 16 Track Sequencer Data .....	69
	<b>5. Connecting MIDI Devices and Computers .....</b>	<b>70</b>
<b>Chapter 4</b>	Troubleshooting .....	72
<b>Appendix</b>	Tone/Style List .....	74
	Expansion Tone List .....	76
	Error Message List .....	78
	Intelligent Chord List .....	80
	Drum Set List .....	82
	DSP Effect List .....	84
	Profiles of Demo Song's Composer .....	85
	MIDI Implementation Chart .....	86
	Specification .....	87
	Index .....	88

# Important Notes

In addition to the items listed under "IMPORTANT SAFETY INSTRUCTIONS" and "USING THE UNIT SAFELY" on pages 2 and 3, please read and observe the following:

## Power Supply

- Do not use this unit on the same power circuit with any device that will generate line noise (such as an electric motor or variable lighting system).
- Before connecting this unit to other devices, turn off the power to all units. This will help prevent malfunctions and/or damage to speakers or other devices.

## Placement

- This device may interfere with radio and television reception. Do not use this device in the vicinity of such receivers.
- Observe the following when using the unit's floppy disk drive. For further details, refer to "Before Using Floppy Disks" (p.8).
  - Do not place the unit near devices that produce a strong magnetic field (e.g., loudspeakers). Install the unit on a solid, level surface.
  - Do not move the unit or subject it to vibration while the drive is operating.
- Do not expose the unit to direct sunlight, place it near devices that radiate heat, leave it inside an enclosed vehicle, or otherwise subject it to temperature extremes. Excessive heat can deform or discolor the unit.

## Maintenance

- For everyday cleaning wipe the unit with a soft, dry cloth or one that has been slightly dampened with water. To remove stubborn dirt, use a mild, non-abrasive detergent. Afterwards, be sure to wipe the unit thoroughly with a soft, dry cloth.
- Never use benzene, thinners, alcohol or solvents of any kind, to avoid the possibility of discoloration and/or deformation.

## Repairs and Data

- Please be aware that all data contained in the unit's memory may be lost when the unit is sent for repairs. Important data should always be backed up on a floppy disk, or written down on paper (when possible). During repairs, due care is taken to avoid the loss of data. However, in certain cases (such as when circuitry related to memory itself is out of order), we regret that it may not be possible to restore the data, and Roland assumes no liability concerning such loss of data.

## Additional Precautions

- Please be aware that the contents of memory can be irretrievably lost as a result of a malfunction, or the improper operation of the unit. To protect yourself against the risk of losing important data, we recommend that you periodically save a backup copy of important data you have stored in the unit's memory and on a floppy disk.
- Unfortunately, it may be impossible to restore the contents of data that was stored on a floppy disk and in the unit's memory once it has been lost. Roland Corporation assumes no liability concerning such loss of data.
- Use a reasonable amount of care when using the unit's buttons, sliders, or other controls; and when using its jacks and connectors. Rough handling can lead to malfunctions.
- Never strike or apply strong pressure to the display.
- When connecting / disconnecting all cables, grasp the connector itself—never pull on the cable. This way you will avoid causing shorts, or damage to the cable's internal elements.
- A small amount of heat will radiate from the unit during normal operation.
- To avoid disturbing your neighbors, try to keep the unit's volume at reasonable levels. You may prefer to use headphones, so you do not need to be concerned about those around you (especially when it is late at night).
- When you need to transport the unit, package it in the box (including padding) that it came in, if possible. Otherwise, you will need to use equivalent packaging materials.
- Do not pull the music stand too far forward when setting/releasing its latches.

### Before Using Floppy Disks

#### Handling the Floppy Disk Drive

- Install the unit on a solid, level surface in an area free from vibration. If the unit must be installed at an angle, be sure the installation does not exceed the permissible range: upward, 0°; downward, 0°.
- Avoid using the unit immediately after it has been moved to a location with a level of humidity that is greatly different than its former location. Rapid changes in the environment can cause condensation to form inside the drive, which will adversely affect the operation of the drive and/or damage floppy disks. When the unit has been moved, allow it to become accustomed to the new environment (allow a few hours) before operating it.
- To insert a disk, push it gently but firmly into the drive—it will click into place. To remove a disk, press the EJECT button firmly. Do not use excessive force to remove a disk which is lodged in the drive.
- Never attempt to remove a floppy disk from the drive while the drive is operating (the indicator is brightly lit); damage could result to both the disk and the drive.
- Remove any disk from the drive before powering up or down.
- To prevent damage to the disk drive's heads, always try to hold the floppy disk in a level position (not tilted in any direction) while inserting it into the drive. Push it in firmly, but gently. Never use excessive force.

#### Handling Floppy Disks

- Floppy disks contain a plastic disk with a thin coating of magnetic storage medium. Microscopic precision is required to enable storage of large amounts of data on such a small surface area. To preserve their integrity, please observe the following when handling floppy disks:
  - Never touch the magnetic medium inside the disk.
  - Do not use or store floppy disks in dirty or dusty areas.
  - Do not subject floppy disks to temperature extremes (e.g., direct sunlight in an enclosed vehicle). Recommended temperature range: 10 to 50° C (50 to 122° F).
  - Do not expose floppy disks to strong magnetic fields, such as those generated by loudspeakers.
- Floppy disks have a "write protect" tab which can protect the disk from accidental erasure. It is recommended that the tab be kept in the PROTECT position, and moved to the WRITE position only when you wish to write new data onto the disk.

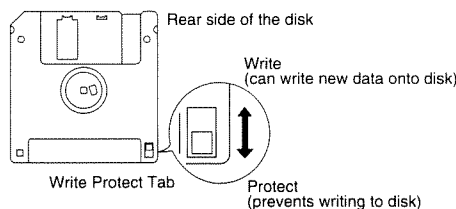

- Disks containing performance data for this unit should always be locked (have their write protect tab slid to the "Protect" position) before you insert them into the drive on some other unit (except the PR-300, or a product in the HP-G, MT, KR, or Atelier families), or into a computer's drive. Otherwise (if the write protect tab remains in the "Write" position), when you perform any disk operations using the other device's disk drive (such as checking the contents of the disk, or loading data), you risk rendering the disk unreadable by this unit's disk drive.
- The identification label should be firmly affixed to the disk. Should the label come loose while the disk is in the drive, it may be difficult to remove the disk.
- Put the disk back into its case for storage.

\* GS (  ) is a registered trademark of Roland Corporation.

\* Apple® is a registered trademark of Apple Computer, Inc., in the United States and other countries.

\* Macintosh™ is a trademark of Apple Computer, Inc., in the United States and other countries.

\* IBM PC® is a registered trademark of International Business Machines Corporation in the United States and other countries.



# Before using the unit

## Setting Up the Music Rest

The music rest sets up easily, its two sections folding as shown in the diagram below. When you want to put the stand away, hold it firmly with your hands, undo the fittings, and slowly collapse the rest.

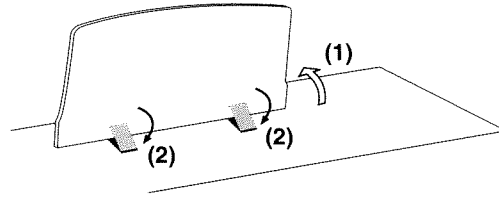

## Opening and Closing the Lid

When opening the unit, hold the lid at the center with both hands, then gently lift the lid and slide it along its slot. To close it, slowly pull the lid toward you until it stops, then gently lower the lid.

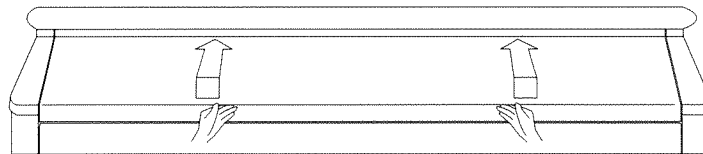

- \* When opening or closing the unit, be sure to grasp the center part of the lid. If you grasp the lid at both ends, your fingers may get caught in the lid's slot. Likewise, please open and close the lid slowly to prevent your fingers from being pinched.
- \* For safety, be sure to close the lid before moving the unit.

## Connecting the Power Cord

1. Place the [Power] switch at the left side of the instrument at Off.
2. After plugging the power cord included with your instrument into the AC inlet jack located on the back of the unit, plug the other end of the cord into a wall socket.

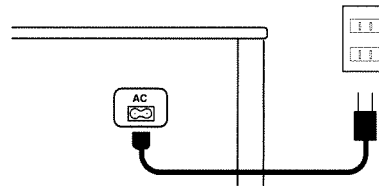

- \* Please use only the power cord that supplied with the KR-770.
- \* If you are not going to be using the unit for an extended period, unplug the power cord from the socket.

## Adjusting the Adjuster

Lower the adjuster at the bottom of the pedal (by rotating it clockwise), so that it touches the floor. If you have the piano placed on carpet, lower it until it pushes into the carpet.

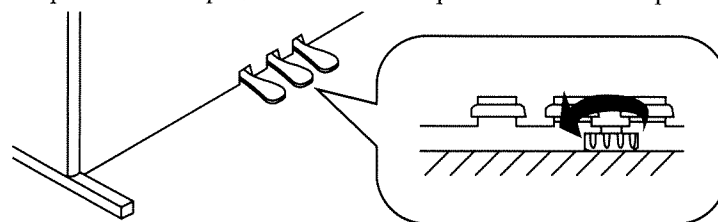

- \* When you move the piano, disconnect the power cord and raise the pedal's adjuster. Then lift the piano while keeping it level, and move it with care, so that you do not drop it on your feet, or get your hands caught.

### Turning on the Instrument

1. Before turning the instrument on, lower the volume with the [Volume] slider on the left side of the panel.
2. Press the [Power] switch on the left side of the panel.  
Several seconds after the power is turned on you will be able to hear sounds played on the keyboard.

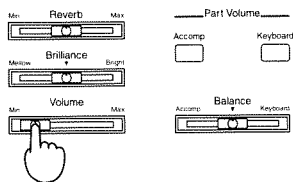

The power is ON when the switch is pressed.

The power is OFF when the switch is pressed again.

- \* In order to protect its circuits, the instrument requires a few moments after turning the power on before it is ready for operation.

### Using Headphones

This unit features two headphones jacks. Two people can use headphones simultaneously, making it convenient during lessons or when playing pieces with another person. The headphones jacks are at the lower left of the unit. When headphones are connected, the keyboard's speaker stops playing, and the sound then comes from the headphones. You can enjoy performing without worrying about bothering anyone around you, even at night.

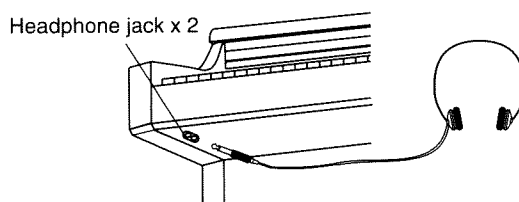

The volume of the headphones is adjusted using the main [Volume] slider.

- \* Please use stereo headphones.
- \* Listening at excessive volume levels for extended periods may result in impaired hearing—please take appropriate cautions.

### Using a Microphone

With the Microphone input featured with the KR-770, you can use a microphone. Sing along karaoke-style using music data as background, do voice-overs while playing the keyboard—you can enjoy singing in a wide variety of situations. The microphone jack is located at the lower right of the rear panel.

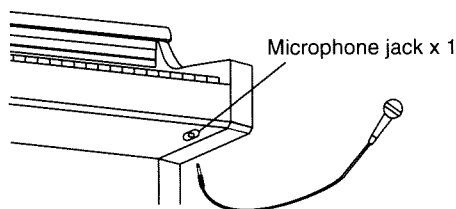

Adjust the microphone volume by using the unit's Microphone [Volume] knob. To adjust the amount of echo to the sound, use the Microphone [Echo] knob.

- \* We ask you to remember to be conscious of the volume level when playing late at night or early in the morning.
- \* Please use the microphone from your home karaoke set. If you are buying a microphone to be used especially with the KR-770, please consult the dealer where you purchased this instrument.

<Cautions with Using the Microphone>

If the volume control on the microphone is turned up when it is plugged into the unit, noise may be produced by the speakers. Please lower the microphone volume on the unit before plugging it in. Depending on the positioning of the microphone relative to the unit's speaker, a "howling" noise may be produced. If this happens, point the microphone in a different direction, or lower the microphone volume.

**Connecting Audio Equipment and Other Electronic Instruments**  
**—The Input and Output Jacks**

With the KR-770, you can play sounds from this instrument through other speakers, as well as have sounds from devices such as CD players play through its speakers.

● **Sending Audio to External Equipment**

Before connecting the KR-770 to another piece of equipment, turn off the power to both devices. When you wish to play sounds from the KR-770 through external speakers, or record your music using a tape recorder, connect the devices by plugging one end of the cable into the Output R/L jack on the rear panel of the instrument, and the other end into the AUX IN or LINE IN jack of the accompanying keyboard amplifier or mixer.

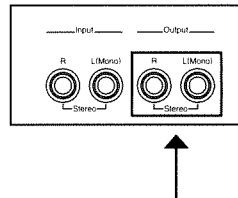

\* If you are connecting the unit to a device with a monaural input, be sure to connect the unit by using the Output L (Mono) jack.

After you have connected the equipment, the next step is to turn on the power. If this is not done in the correct sequence, there can be a danger of malfunction, or even blown speakers.

1. Turn on the power to the KR-770.
2. Turn on the power to the connected device.  
 When switching off the power, turn off the devices in the reverse order.

● **When Playing Sounds From External Equipment Through The KR-770's Speaker(s)**

Before connecting this instrument to another piece of equipment, turn off the power to both devices. When you want to play sounds from another device such as a CD player or additional synthesizer, connect the equipment by plugging one end of the connecting cable into the Input L/R jack on the rear panel of the KR-770, and the other end into the LINE OUT jack of the connected device.

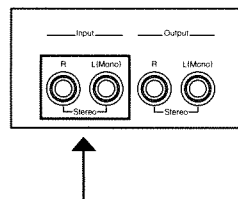

\* If you are connecting the unit to a device with a monaural output, be sure to use the Input L (Mono) jack on this unit.

After you have connected the equipment, the next step is to turn on the power. If this is not done in the correct sequence, you risk causing a malfunction, or even blown speakers.

1. Turn on the power to the connected device.
2. Turn on the power to the KR-770.  
 When switching off the power, turn off the devices in the reverse order.

# Panel Descriptions

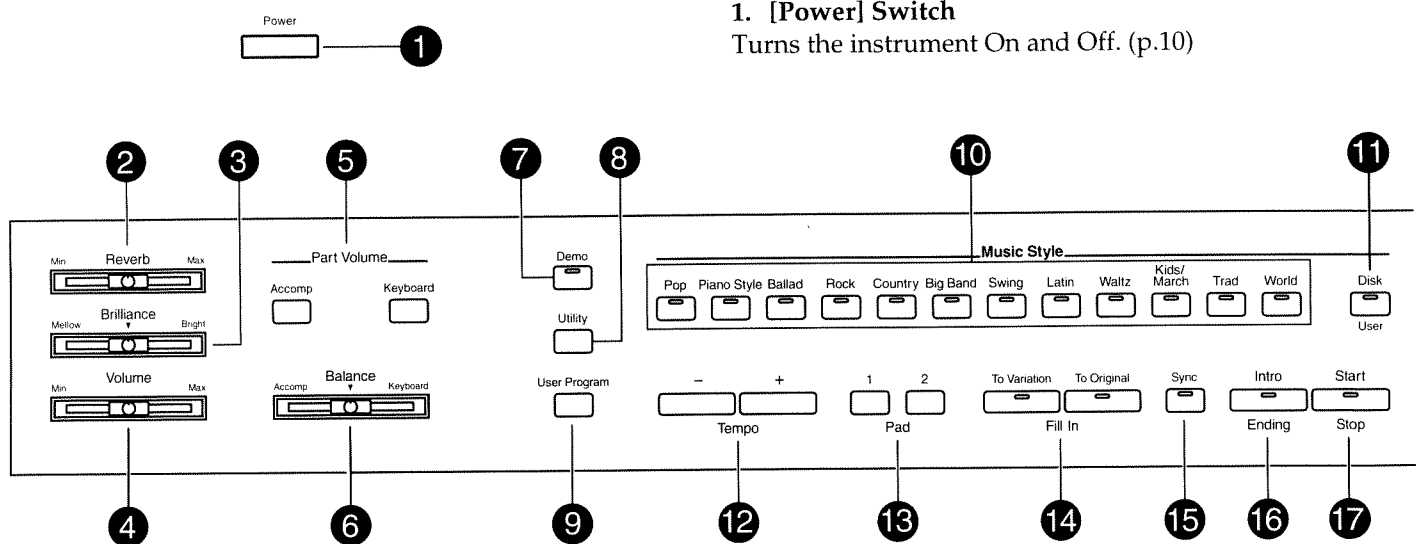

## 1. [Power] Switch

Turns the instrument On and Off. (p.10)

## 2. [Reverb] Slider

Adjusts the level of the reverb effect. (p.28)

## 3. [Brilliance] Slider

Adjust the level of brilliance of the sound. Moving the slider to the right increases the brightness of the tone, and moving it to the left makes the sound more subdued.

## 4. [Volume] Slider

Adjusts the instrument's overall volume.

## 5. Part Volume Button

Adjust the volume of each individual part in a Performance. (p.41)

## 6. [Balance] Slider

With this, during the performance of a Style, you can adjust the balance of the volume levels of the accompaniment and the melody. (p.36)

## 7. [Demo] Button

You can view an introduction to the functions of the KR-770 on the screen, and with a game-like program, learn how to identify sound and chords. (p.17)

## 8. Utility Button

This is used to make various Performance settings. (p.65)

## 9. [User Program] Button

Program panel settings as "User Programs," and call up recorded User Programs. (p.62)

## 10. Style Group Button

Selects Music Style group. (p.33)

## 11. [Disk/User] Button

Used to call up either Disk Styles (p.39) or User Styles. (p.52)

## 12. Tempo Button

Provides adjustment of the tempo during a performance. (p.36)

## 13. Pad Button

With this button you can assign various functions relating to performances. (p.63)

## 14. Fill In Button

- Used to select the accompaniment pattern for a Music Style. (p.37)
- Used to switch from the accompaniment pattern to a Fill-In during a performance. (p.37)

## 15. [Sync] Button

Allows you to start a Music Style with the timing used when you start playing the keyboard. (p.34)

## 16. [Intro/Ending] Button

Press this button when you want to start a Style performance with an intro, or when you want an ending to close the performance. (p.34)

## 17. [Start/Stop] Button

Used to start or stop a Style performance. (p.34)

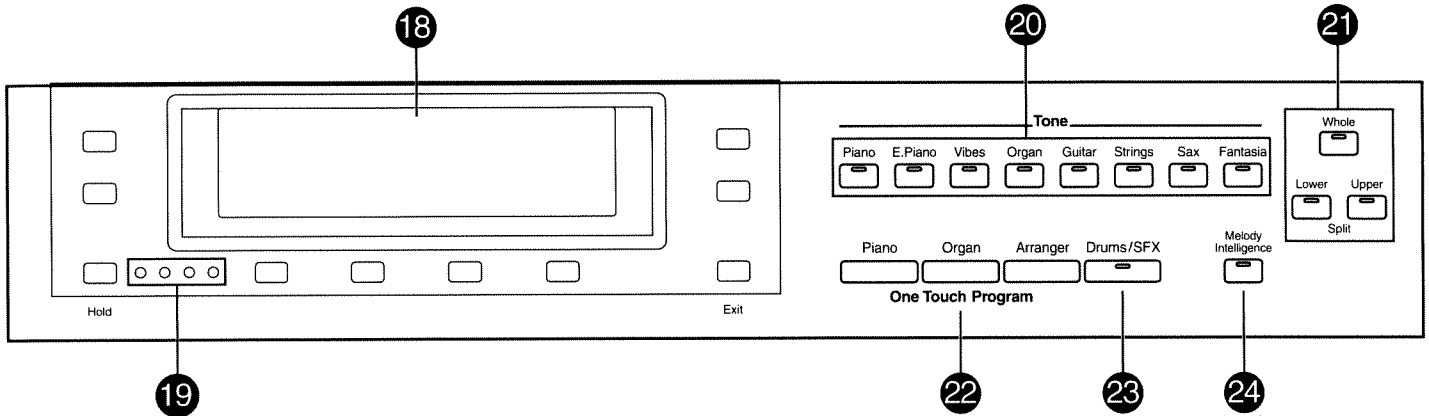

## 18. Display

Displays various information relating to the current operation.

## 19. Beat Indicator

This indicator flashes in time to the beat of the selected Style or Performance data.

## 20. Tone Group Button

Used to select a Tone Group. (p.27)

## 21. Part Buttons

The lit indicators on the Part button allow you to easily check which Part is currently selected.

### [Whole] Button

Use this button when you want to select one tone for the entire keyboard. (p.29)

Can be used in Piano Style Arranger play. (p.32)

### [Lower] Button

This button is pressed when the keyboard is in Split Play. (p.30)

It is used to adjust the Lower tone. (p.30)

### [Upper] Button

It is used to adjust the Upper tone. (p.30)

## 22. One Touch Program Button

This feature makes it possible to instantly access a desired Performance with one touch, no matter what the current panel settings are. (p.19)

## 23. [Drums/SFX] Button

When pressed, allows Drum Sounds and Effects to be played. (p.24)

## 24. [Melody Intelligence] Button

This is used when you want to add a harmony to be added to the melody being played. (p.40)

## Panel Descriptions

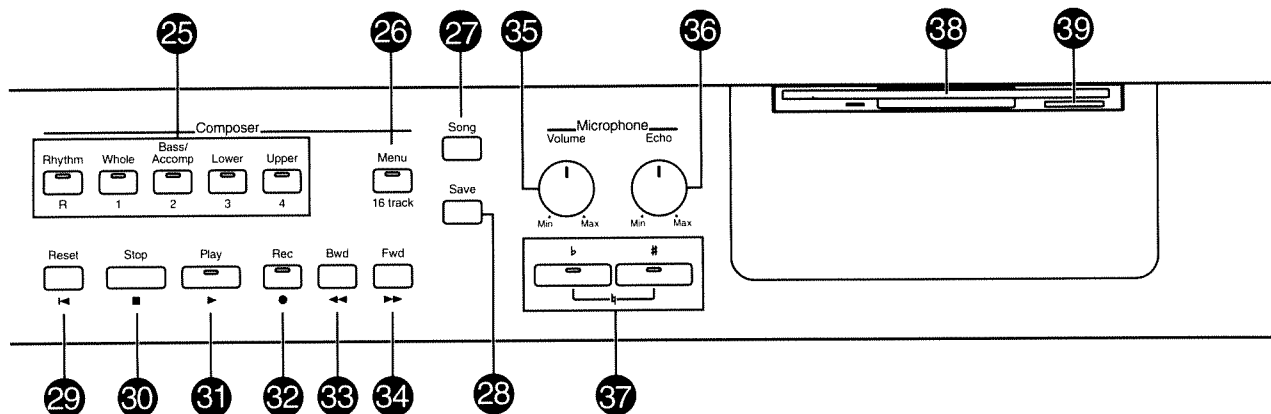

### 25. Track Button

Used to select the tracks to be recorded on or muted. (p.42)

### 26. [Menu] Button

Used to select menus used in various recording functions such as 16 Track Sequencer, Style Composer, and Edit. (p.49)

### 27. [Song] Button

Used to select performances on floppy disks. (p.24)

### 28. [Save] Button

Press this button to save recorded material to floppy disks. (p.46)

### 29. [Reset] Button

Pressing this button returns you to the beginning of the song.

### 30. [Stop] Button

Stops playback or recording of the music being played.

### 31. [Play] Button

Used to begin playback of a performance.

### 32. [Rec] Button

Press this button to begin recording a performance.

### 33. [Bwd] Button

"Rewinds" the song/data sequentially.

### 34. [Fwd] Button

Used to "Fast Forward" through the musical data.

### 35. Microphone [Volume] Knob

Adjusts the volume of the microphone connected to the KR-770. (p.26)

### 36. Microphone [Echo] Knob

Adjusts the amount of echo added to the microphone input. (p.26)

### 37. [b]/[#] Buttons

Changes the key of the performance data. (p.26)

### 38. Disk Drive

Used when carrying out such functions as playing back material recorded on floppy disks, or saving recorded performances to floppies.

### 39. Eject Button

Pressed when you want to eject the floppy disk.

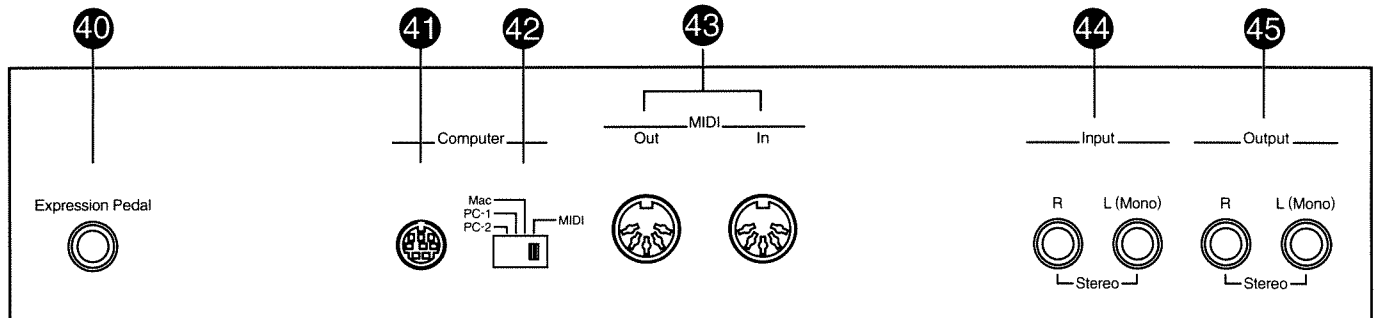

### 40. Expression Pedal Jack

When an expression pedal (sold separately) is connected here, you can control the volume with your foot.

### 41. Computer Connector

When you want to exchange performance data between this unit and a computer, plug in the computer output cable into this connector. (p.70)

### 42. Computer Switch

This switch is set before connecting external MIDI devices or computers to the KR-770. (p.70)

### 43. MIDI Connectors

The MIDI cable plugs into this connector when you are going to exchange MIDI performance information with an external MIDI device. (p.70)

### 44. Input [R]/[L (MONO)] Jacks

You can play output from tape recorders and CD players by connecting these sources to the KR-770's input terminal. (p.11)

### 45. Output [R]/[L (MONO)] Jacks

When you wish to play sounds from the KR-770 through other speakers, or record the output with a tape recorder, use this connector to connect cables to such equipment. (p.11)

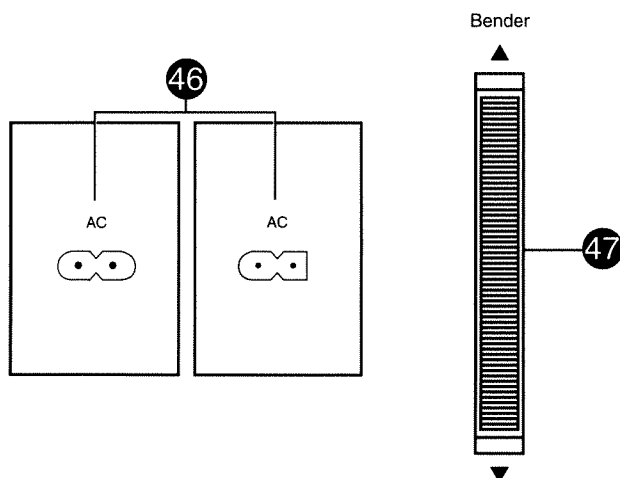

### 46. AC Inlet

The AC power cable connects here. (p.9)  
AC Inlet jack located on the back of the unit.

### 47. Bender (Pitch Bend Wheel)

If you move the wheel forward or backward while a note is sounding, the pitch will change smoothly. Moving the wheel away from you raises the pitch, and moving the wheel toward you lowers the pitch.

\* You cannot use the Pitch Bend function for the Lower Part.

\* You can change the range of the pitch. (see. p.67).

# Basic Operation and How to Read the Display

This instrument features a large-sized screen on which various information is displayed. Numerous operations involve using this display screen.

## Typographic Conventions Used in this Owner's Manual

This Owner's Manual uses the following typographic conventions to indicate panel buttons and items appearing on the display.

[ ] : This indicates a button or slider on the panel.

Example: Press the Tone Group [Piano] button.

< > : This indicates an item appearing on the display. To choose such an item, press the corresponding button (located below or to the side of the item).

Example: Press <Func...> on the display.

## The Basic/Home Screen

During ordinary performances, the following "Basic Screen" will appear in the display.

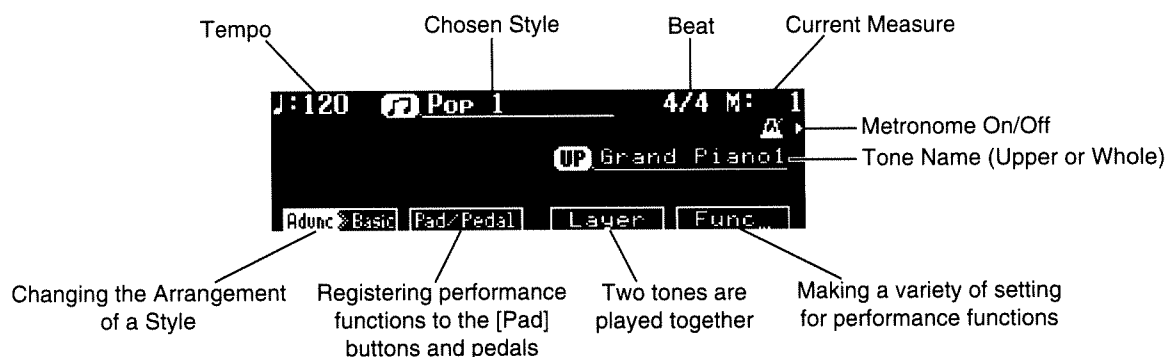

## How to Perform Operations Using the Screen



Go to the previous page      Go to the next page

## Changing Screen Pages—<Page ►►►◀◀◀ Page>

Some screens may be composed of multiple pages.

By pressing <Page ►►► you will continue to the next page.

Pressing <◀◀◀ Page> returns you to the previous page.

## Retaining a Screen—The [Hold] Button

Depending on the screen being displayed, after several seconds you will be returned to the previous screen, or to the Basic screen. At times when you do not want the screen to change, you can keep the current screen in the display by pressing the [Hold] button.

## Returning to the Previous Screen, or to the "Basic" Screen—The [Exit] Button.

By pressing the [Exit] button, you will be returned to the previous screen, or to the Basic screen.

\* You can adjust the contrast of the display. Please refer to "Adjusting the contrast of the Display" (p.67).



# 1-1 Overview of the KR-770

## An Introduction to the Functions—[Demo] Button

Let's use the display to take a look at the functions the KR-770 has to offer. Just follow along on the display.

1. **Press the [Demo] button.**  
A "Demo screen" like the one below appears on the display. The Demo screen is made up of three pages.
2. **Press <▲> and <▼> at the right of the display to change the Demo screen.**  
The screen changes, allowing you to view the introduction to other functions.
3. **Press a button at the bottom of the display to choose an item.**  
A screen showing the functions and operation of the selected item appears.
4. **Press the [Demo] button to end the Demo Screen.**  
*\* If you wish to make other settings, press the [Demo] button to end the Demo screen.*

## How to Use the Demo for <Sound>

You can listen to a demo performance that uses the KR-770's built-in Tones.

1. **At the Demo screen, press <Sound>.**
2. **Press <Demo> at the bottom right of the display.**
3. **Use the buttons at the side of the display to choose the instrument you want.**  
A demo song using that instrument is played.  
The number of demo songs varies according to the instrument. When the first song ends, the next one starts to play.
4. **You can listen to the second Demo performance by pressing the same button again.**  
Each time you press the button, the next song is played.  
The performance stops automatically when all songs have been played.  
*\* Please refer to "Profiles of Demo Song's Composer" (p.85) for the information of demo songs.*  
*\* All rights reserved. Unauthorized use of this material for purposes other than private, personal enjoyment is a violation of applicable laws.*  
*\* No data for the music that is played will be output from MIDI Out.*

## Using <Language> to Choose the Language of the Screens

The Basic menu and part of the Demo menu can be displayed in other languages.

1. **At the Demo screen, press <Language>.**
2. **Use the buttons at the side of the display to choose the language.**  
*\* The settings reverts to the original language when the power is switched off. If you want to save the setting even when the power is turned off, take a look at "Memory Backup" (p.69).*

### How to Use <Game>

Selecting <Game> lets you play a note-guessing or chord-guessing game.

1. **At the Demo screen, choose <Game>.**
2. **Use the buttons at the bottom of the display to choose a game.**  
From left to right, the games displayed are "Guess the Note," "Guess the Chord," and "Chord Practice."
  - Guess the Note.....Listen to the sound that's played, and guess what note it is.
  - Guess the Chord .....Listen to the chord that's played, and guess what notes are used to make it up.
  - Chord Practice .....Look at the chord and try to play it.

Here's how the game progresses.

3. **Use the buttons at the bottom of the display to choose either "Beginner" or "Advanced."**  
The problem appears on the display.  
↓  
A few seconds after the problem is shown, the first hint appears in the center of the screen.  
↓  
After a few more seconds, the second hint appears in the center of the screen.  
↓  
Try to answer before time runs out.  
The faster you guess correctly, the better your score.

# 1-2. The KR-770's Performance Functions

## One Touch Program

By pressing the One Touch Program [Piano], [Organ], or [Arranger] buttons, you will be able to immediately access desired performances with just one touch, regardless of what the current panel settings are.

## Let's Try a Piano Performance—The One Touch Program [Piano] Button

This is the default setting when the power is turned on.

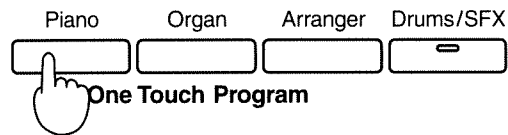

### 1. Press the One Touch Program [Piano] Button.

A picture of a piano will appear on the screen, and at this point a piano performance can be played using the entire keyboard.

The piano tone setting will be set to "Grand Piano 1."



This screen is called the "Piano Screen."

## Let's Try Adjusting the Piano Tone—Opening and Closing the Lid

With the KR-770, you can simulate the change in tone of a grand piano that comes about when the piano's lid is opened more, or less.

### 1. Press the One Touch Program [Piano] Button, and the Piano screen will appear.

Pressing <▲Open> and <▼Close> adjusts the amount of the "opening" of the piano lid.

Each time you press the <▲Open> button, the lid of the piano shown on the screen will open more, creating a brighter tone.

Each time you press the <▼Close> button, the lid of the piano shown on the screen will close more, creating a mellower tone.

## Let's Turn On the Metronome

The KR-770 features a metronome function. When you want to practice using a precise tempo, try playing the metronome to keep in time.

Each time you press the button to the right of the metronome shown above the display, the metronome will be turned on or off.

When desired, adjust the tempo with the Tempo [+] and [-] buttons.

Pressing the [+] and [-] buttons simultaneously will return the keyboard to the default standard tempo.

\* You can change the metronome's volume and beat. Please refer to "Changing the Volume and Beat of the Metronome" (p. 58, 66).

\* The metronome's beat and tempo will be the same as that of the presently selected Style.

## 1-2. The KR-770's Performance Functions

### Let's Use the Pedal

When the KR-770 is turned on, or when the One Touch Program [Piano] button is pressed, the three pedals function in the following manner:

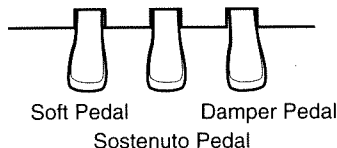

- Soft Pedal                      Pressing the Soft pedal yields a softer tone.
- Sostenuto Pedal              When you step on the Sostenuto pedal, only the tone of the depressed keys are sustained. There is no effect on the tone of notes played afterward.
- Damper Pedal                 Pressing the Damper pedal the overall tone is sustained.

\* *The functions of the three pedals differ in Style Play and Split Mode.*

### The Function Menu—<Func...>

This feature is used to make settings for the various functions related to Piano performances. For more detailed information, please refer to "Piano Screen Functions" (p.58).

This instrument features many tones besides the piano tone. If you should want to play using a different tone, please refer to "Selecting Tones" (p.27).

### Let's Try an Organ Performance

#### —The One Touch Program [Organ] Button

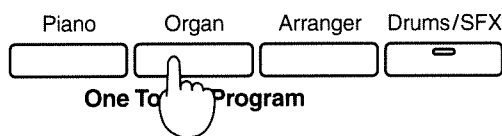

#### 1. Press the One Touch Program [Organ] Button.

A picture of an organ will appear on the screen, with the keyboard being split at F#3 into Lower (left hand) and Upper (right hand) keys.

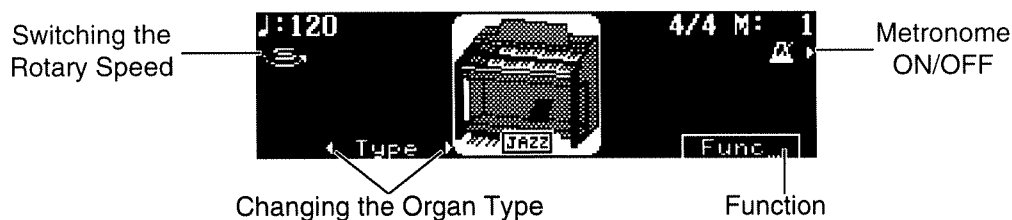

This screen is called the "Organ Screen."

A Jazz Organ tone, "Lower Organ 1" in the Lower keys and "Jazz Organ 1" in the Upper keys, has been preset.

### Let's Try Adjusting the Rotary Effect—Rotary Speed

The Jazz Organ tone has a rotary effect added to it. This simulates the effect obtained when a speaker is rotated.

Change the speaker rotation speed by switching between the two available speeds: each press of the button toggles the rotation speed between S (Slow) and F (Fast).

### Let's Select an Organ Type—< ◀ Type><Type ▶ >

Use < ◀ Type> and <Type ▶ > to make your selection.

The selected organ type is retained until power is turned off. Any time after you have chosen an organ type, you can begin playing using that selection merely by pressing the One Touch Program [Organ] button.

\* *When the power is switched off, the organ type is reset to "Jazz Organ."*

### The Function Menu—<Func...>

This feature is used to make settings for the various functions related to organ performances.

For more detailed information, please refer to "Organ Screen Functions" (p.60).

## Let's Try Playing a Style—The One Touch Program [Arranger] Button

The KR-770 comes with an "Arranger" function which makes it possible for you to enjoy playing ensemble performances of various musical genres—all by yourself!

From prepared Music Styles in each musical genre, this Arranger function automatically creates and plays accompaniment to match the chords being played. This kind of performance using the Arranger function is called "Style Play."

### A Simple Explanation of How to Use Style Play

Before actually trying to use Style Play, let's first take a look at the sequence of procedures involved.

**1. Press the One Touch Program [Arranger] Button.**

The keyboard is now split at F#3 into accompaniment in the Lower (left hand) keys and the Upper (right hand) keys.

**2. Select a Style.**

**3. Play a chord in the Lower keys, and the accompaniment will start.**

An intro plays at the beginning of the piece, so the melody begins to play in the Upper keys after the intro is completed.

Adjust the pace of the accompaniment with the Tempo button.

The following features allow you to make simple chord settings:

- You can set chords with one finger (see "Easy Fingering For Chords" (p.38))
- It is not necessary to hold down one chord until the next one is played. After playing one chord, you can then go ahead and lift your hands from the keyboard, allowing you to get ready to play the next chord.

**4. When the performance is over, press the [Intro/Ending] Button.**

What do you think? Do you see how that goes together?

Now let's try actually Style Play at the next step.

## 1-2. The KR-770's Performance Functions

### Let's Play "When The Saints Go Marching In"

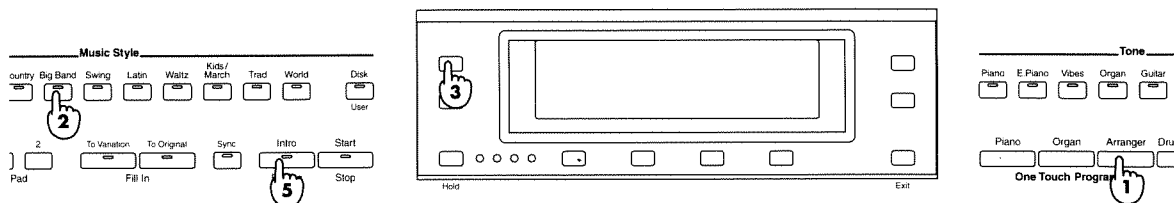

1. Press the One Touch Program [Arranger] Button.

The "Basic Screen" will appear in the display, and when you play the Style, the chords being played are shown.



2. Select the [Big Band] button from the Style Group.
3. From the list of Styles shown in the display, select <Jazz Band>.



The Style ("Jazz Band") has now been selected.

After a few seconds, the Basic Screen returns to the display.

4. When you play the "Do" (C chord) key in the score below, the accompaniment will begin playing.

At the beginning, a eight-measure intro is played, so after the intro is finished, you can begin playing the melody.

Let's try playing while learning how to play the "Right" and "Left" shown beneath the score.

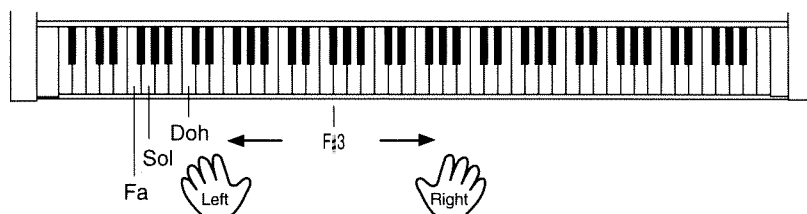

If you want to slow down the accompaniment, press the Tempo [-] button.

If you would rather speed the accompaniment up, press the Tempo [+] button.

Pressing the [+] and [-] buttons simultaneously will return the keyboard to the default standard tempo.

5. When the performance is over, press the [Intro/Ending] Button.

If you would like to start the performance playing again, press the [Sync] button. After that, when you play "Do" (C chord) in the lower keys, the accompaniment will begin playing.

\* There are many ways to start and stop a Style. Please refer to "Starting and Stopping Styles" (p.33).

# When The Saints Go Marching In

American Traditional

**Right** C E F G C E F  
**Left** Doh

**Right** G C E F G E C E  
**Left**

**Right** D E E D C C E G  
**Left** Sol Doh

**Right** G F E F G E C D  
**Left** Fa Doh Sol

**Right** C C E F C  
**Left** Doh Doh

To Variation      Intro/Ending

**Once you feel you know your way around when playing on the keyboard, let's try adding some changes while the song is playing.**

Where "To Variation" is indicated in the music, press the Fill In [To Variation] button.  
 Did that change the feeling of the song?

**Choosing a different Style creates a different mood in the performance**

Let's check out the various Styles, and try to find one that really goes well with the song.  
 Example: "March 4/4," "March 6/8" (Style Group: Kid's/March)  
 For more on how to select Styles, please refer to "Selecting Styles" (p.33).

\* If you want to perform using other tones in the Upper part, please refer to "Selecting Tones" (p.27).

## 1-2. The KR-770's Performance Functions

### Let's Try Some Drum Sounds and Effects—The [Drums/SFX] Button

You can have various drums and effects sound while you play the keyboard.

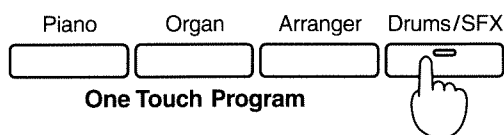

1. Press the [Drums/SFX] button.

"Drum Screen" set will appear in the display.

Depending on the key played, various drum sounds will be produced, while in the display, pictures of each drum will be shown.

- \* For more on each key's drum sound or effect, please refer to the "Drum Set List" (p.82).

If you press the [Drums/SFX] button once more, or press the [Exit] button, you will be returned to the previous screen.

### Let's Try Switching Drum Sounds and Effects

1. Press <SFX>.

"SFX Screen" will appear in the display.

Depending on the key played, various effects will be produced; while in the display, pictures representing each effect will be shown.

Press <Drums>.

The screen in the display will switch to the Drum Screen.

With each press of the button you will toggle between drums sounds and effects.

### Let's Select a Drum Set Type—< ◀ Type > ▶ >

1. Press < ◀ Type > ▶ >. Each time you press the button,

The drum set type will change, and the names of the drum sets appearing in the display will change.

- \* For more on drum set types, please refer to the "Drum Set List" (p.82).

### Let's Listen to Some Music Data—Playing Back Disk Performances

This unit features an internal disk drive. With this, you can enjoy material such as commercially available music data, or performances you have created and saved onto disk. You can play all of this back using the same procedures.

- \* Before using disks, please carefully read "Before Using Floppy Disks" (p.8).

1. Insert the music data disk into the floppy disk drive.

2. Press the [Song] button.

The following "Song Select Screen" will appear in the display.

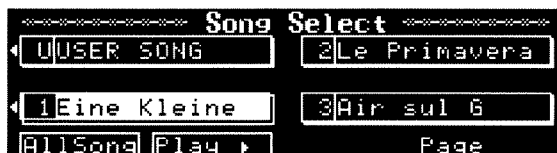



- \* If a performance has been recorded on the KR-770, you can't listen to the music data unless you delete the performance or save it to disk. In this case, press the [Song] button to display a screen like the one shown below.

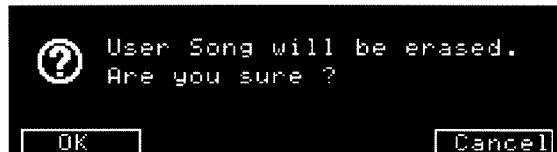

For more on how to erase or save data, please refer to "Erasing Recorded Performances" (p.46) or "Saving Recorded Performances to Disk" (p.46).

### Selecting and Playing Back Songs

3. By pressing the buttons next to the display screen, you can select the songs you want to listen to.  
When there are multiple pages in a Song Select Screen, use <Page ►►> and <◄◄ Page> to show other pages.
4. Press <Play ►> or the [Play] button.  
The performance will begin.  
After several seconds, the previous screen will return to the display.
  - \* For songs which do not begin on the downbeat of the first measure, "PU" (Pickup) will appear in the display when the song begins. After that, measure numbers will be displayed.
5. The program stops automatically when the performance is finished.  
To stop while the performance is running, press <Stop ■> or the [Stop] button.  
If you press the [Reset] button, the performance stops and is rewound to the beginning of the first measure.

### When You Want to Play All Songs One After Another

- 3'. Press <All Song>.  
The entire group of songs will begin playing in order.  
The set will repeat if you do not stop the performance.
- 4'. To stop while the performance is running, press <Stop ■> or the [Stop] button.  
If you press the [Reset] button, the performance stops and is rewound to the beginning of the first measure.

### Rewinding and Fast Forwarding

By pressing the [Fwd] and [Bwd] buttons, you can play back any section of a song by advancing to later measures or returning to previous ones.  
Each press of one of the buttons moves you ahead or back one measure at a time, and when you hold the button down, the movement is continuous.

- \* Depending on the performance data, rewinding and fast forwarding may take considerable time.
- \* You can also play parts containing music data yourself. Please refer to "Temporarily Muting Sounds on Specific Tracks" (Track Mute) (p.44).
- \* If any of the music data is marked, only that portion can be repeated. For more detailed information, please refer to "Repeatedly Playing Back the Same Section." (p.59).

## 1-2. The KR-770's Performance Functions

### Let's Sing Using the Microphone

Let's hook up a microphone and try singing some karaoke. You can adjust the key as well as the amount of echo added to the sound.

Here, we will demonstrate how to use the karaoke function using a music data disk sold by Roland.

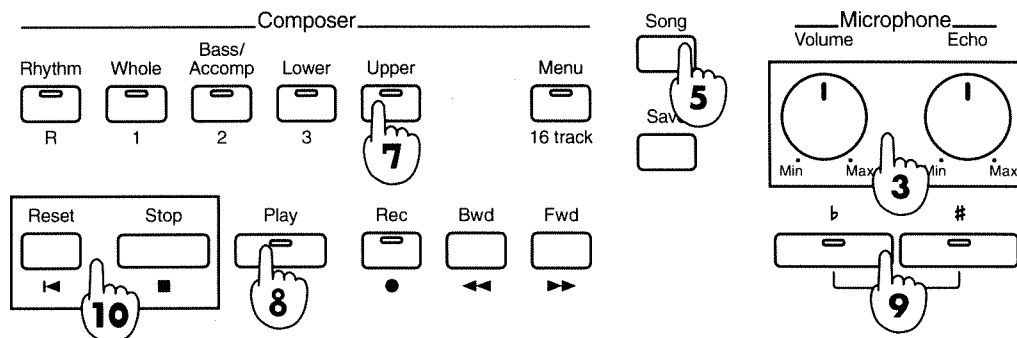

1. Before connecting the microphone, first lower the microphone volume by turning the Microphone [Volume] control all the way to "Min".
2. Plug the microphone cable into the Microphone jack.
3. Using the Microphone [Volume] and [Echo] knobs, adjust the microphone's volume and the amount of echo.
4. Insert the music data disk into the floppy disk drive.
5. Press the [Song] button.  
The Song Select screen will appear.
6. Select a song using the buttons located to the side of the display screen.
7. Press the Composer [Upper] button, and the button's indicator will go out.  
This is done to prevent the melody from sounding.
8. Press <Play ►> or the [Play] button.  
Playback will begin, but without the melody sounding. Go ahead and sing along with the accompaniment!
9. If you find the key difficult to sing in, try adjusting the key with the [b] and [#] buttons.  
Each time you press the [b] button, the key will be lowered a semitone; each time you press the [#] button, the key will be raised a semitone.  
Pressing the [b] and [#] buttons simultaneously will return the data to the original key.
10. The song stops automatically when the performance is finished.  
To stop while the performance is running, press <Stop ■> or the [Stop] button.

# 2-1. Tones

## Selecting Tones

There are many onboard tones besides the piano tone available on this keyboard. The tones are divided into eight separate categories. These categories are called tone groups.

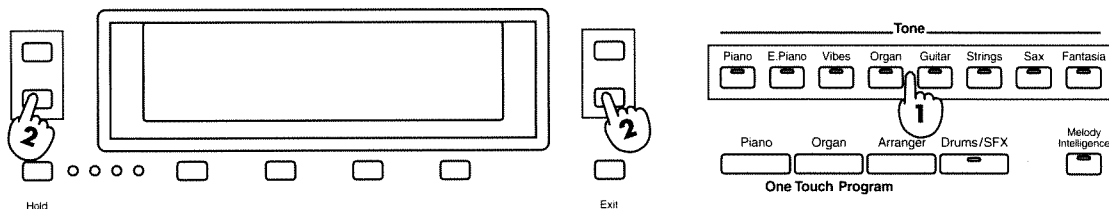

## Selecting a Tone Group

1. Press the Tone Group Button.

The button's indicator will go on, and the following "Tone Select Screen" will appear in the display.



## Selecting Tones (Normal)

There are numerous tones in each tone group. After choosing a Tone Group, let's choose a tone from the Tone Select screen.

2. Select a tone by pressing the buttons to the side of the display screen.

The name of the tone selected will be highlighted in the display.

Try playing the keyboard to confirm that the tone indeed has been changed to the one you selected.

The Style Select screen is composed of multiple pages. Use <Page ►►> and <◀◀ Page> to bring up other pages to the screen.

- \* When you want to try out a number of different tones from one tone group, pressing the [Hold] button will fix the Tone Select screen in the display window, so it becomes unnecessary to press the same tone group button over and over, making the procedure more convenient.
- \* The number of tones in each group varies. For a look at the number of tones, tone names, etc., please refer to the "Tone List" (p.74).
- \* By selecting Expansion Tones, you can enjoy a greater number of tones. Please refer to "Selecting Expansion Tones" (p.67).
- \* You can alter the tones in various ways, such as adding interesting effects to them, or changing their pitch by an octave. Please refer to "Adding Effects to Tones" (p.28) and "Changing the Sound's Pitch by Octaves—Octave Shift (p.29).

### Adding Effects to Tones

#### Adding Reverberation to the Tone—The [Reverb] Slider

Reverb is the reverberation effect added to tones that makes them sound as though they are being played in a concert hall.

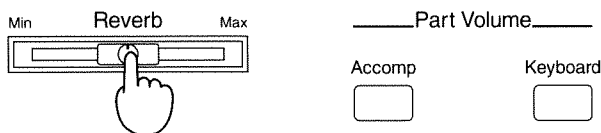

1. Adjust the amount of reverb effect by using the [Reverb] Slider.

Moving the slider all the way to the right gives maximum reverb, and moving completely to the left end removes all reverb from the sound.

- \* You can select from a number of different types of reverb. (p.66)
- \* The adjustment in reverb affects only the tone currently selected when the keyboard is being played. You cannot adjust the sound of the accompaniment or of sounds played back with the Composer function.

#### Adding Various Effects to Tones—DSP Effect

You can add different effects to tones.

For more detailed information, please refer to “DSP Effect List” (p.84).

1. Select <DSP...> from the Tone Select screen.

The screen will change, and a screen like the one shown below will appear in the display.

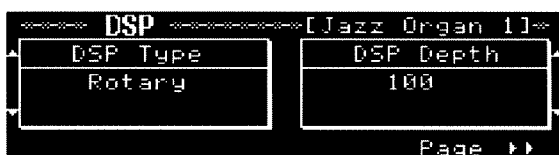

2. Select the type with the buttons to the left of the display, and select the amount of the effect with the buttons to the right of the display.

When you wish to remove the DSP Effect, select “OFF” from the Type screen.

- \* You can not add multiple DSP effects simultaneously.
- \* When you set Upper, Lower or Whole with the Rotary Effect, you can switch the rotation speed with the button at the upper left of the display.

#### Adding Breadth to Tones—Chorus Effect

You can add a chorus effect to Tones. Chorus is an effect that creates a more spacious, “fatter” sound.

1. After pressing <DSP...> on the Tone Select screen, press <Page ▶▶>.

The screen will change, and a screen like the one shown below will appear in the display.



- Turn the effect on and off with the buttons to the left of the display, and select the amount of the effect with the buttons to the right of the display.  
After several seconds, the previous screen will return to the display.
- \* You can select from and switch between a number of different types of chorus. Please refer to “Changing the Type of Reverb or Chorus Effect” (p.66).

## Changing the Sound’s Pitch by Octaves—Octave Shift

Octave Shift is a function that changes the pitch of a sound in octave steps. You can set Octave Shift on every tone and in each Part. For example, say that the Octave Shift of the E.Piano 1 tone in the Upper Part is set to “0,” and the Octave Shift of the E.Piano 1 tone in the Lower Part is set to “+1” (raising the tone one octave)—even though it is the same tone, you can change the settings for the different Parts.

- Select a tone on which to use Octave Shift from the Tone Select screen.
  - Select the value (amount) of the change you want by pressing <Octave>.  
You can raise or lower the pitch a maximum of two octaves.  
After several seconds, the Basic screen will return to the display.
- \* When power to the instrument is turned on, the most appropriate pitch for each tone is set according to its Octave Shift setting.
- \* Although when the instrument is turned off, Octave Shift values are returned to preset numbers, you can save these values in the KR-770’s memory. Please refer to “Memory Backup” (p.69).
- \* You cannot use Octave Shift while in Whole Keyboard Play.

## Playing Using One Tone for the Entire Keyboard

### —Whole Keyboard Play

Playing the keyboard while using the same tone for every key is known as “Whole Keyboard Play.” Even when you press the One Touch Program [Piano] button, Whole Keyboard Play is engaged.

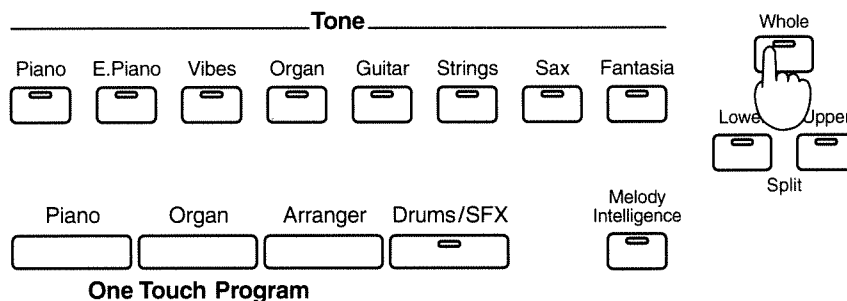

- Press the Part [Whole] button.  
The button’s indicator will go on, and the tone selected for the Upper Part will be extended to the entire keyboard.
- \* If you press the Part [Whole] button while in Style Play, you will go into “Piano Style Arranger Play” (see p.32).

### Playing With Different Tones in the Left and Right Hand—Split Play

You can have one key on the keyboard, acting as a border, divide the keyboard into a Lower (left hand) part and an Upper (right hand) part, and perform with different tones in each of the parts. Playing while the keyboard is divided into Lower and Upper parts is known as “Split Play.”

The point or key where the division takes place is called the Split Point.

The Split Point is reset to F #3 when the instrument is turned on. The Split Point is included in the Lower Part.

Even when you press the One Touch Program [Organ] button and select “Jazz Organ,” Split Play is engaged.

#### When Splitting

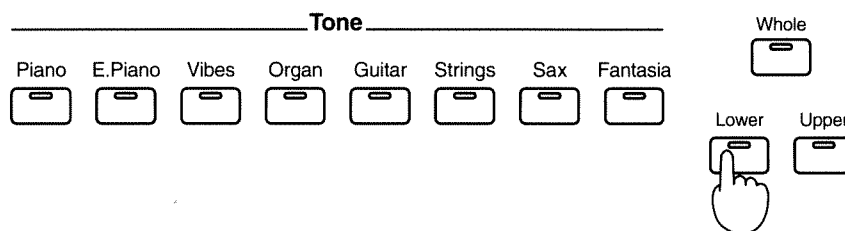

##### 1. Press the Part [Lower] button.

The Part button's indicator for both [Upper] and [Lower] will turn on, and at that point the keyboard will split.

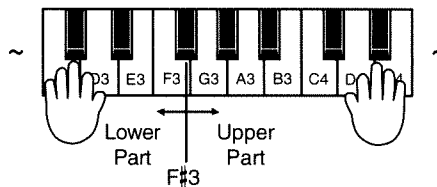

Try playing the keyboard to confirm that different tones are being played in the Lower and Upper Parts. When in Split Play, tone names in the Lower and Upper Parts are displayed on the Basic screen.



The tone in the Upper Part is the tone selected in Whole mode before the keyboard is split. A prerecorded tone is used in the Lower part. When the KR-770's power is turned on, the Lower tone is set to “Strings.”

#### When Changing Tones

##### 1. Press the button for the part (the [Lower] button or the [Upper] button) whose tone you wish to change.

The position of the < ► > on the Basic screen will change.

\* The part whose tone you will be able to change is the one shown on the Basic screen with the < ► > next to its name.

##### 2. Press the Tone Group button.

The Tone Select screen will appear in the display.

##### 3. Select a tone.

After several seconds, the Basic screen will return to the display.

- \* When you change the tone of a Part with the <▶> pointing at it, it is not necessary to press the Part button.
- \* You can change the location where the keyboard is split. Please refer to “Turning the Lower Tone On and Off/Changing the Split Point” (p.60).
- \* Pitch may change when the keyboard is split. This is due to the setting most appropriate for a selected tone when it is in Octave Shift.

## Sounding Two Layered Tones—Layer Play

Having two sounds layered and playing simultaneously is called “Layer Play.” For example, you can do something like layer and then play a performance using a piano tone and strings. When playing a performance in Layer play, Press <Layer> on the Basic screen. Press it again and you can cancel the Layer Play.

- \* The Lower Part cannot play in Layer play.
- \* When you make Layer settings, pre-select tones you like for the tone groups.  
Example: We will layer piano and strings, then play the result.

1. Press the Tone Group’s [Piano] button.
2. Press <Layer> on the Basic screen.



3. Press the Tone Group’s [Strings] button.  
The indicator in the buttons of the two Tone Groups you have just selected will go on. Try playing the keyboard to confirm that the keyboard is producing the sounds of the two layered tones. The two are called “Upper Tone” and “Layer Tone.”
- \* In Layer Play, the Tone Select buttons become the selection button of Layer Tone.  
When you want to change the “Upper Tone,” after you cancel the Layer play, select a tone, the press <Layer> once more.
  - \* By pressing two tone group buttons simultaneously, you can go into Layer Play.

# 2-2 Style Play

## Settings for Playing in Style Play

1. Pressing the One Touch Program [Arranger] button will create the following Style Play settings:
    - The Sync Start function, with the Styles' intro is in standby (p.34);
    - The keyboard will be split at F#3, with the Lower part used for accompaniment and the Upper part used for melody;
    - A Tempo and Upper Tone appropriate for the selected style;
- \* You can change the location where the keyboard is split. Please refer to "Turning the Lower Tone On and Off/ Changing the Split Point" (p.60).
- \* In Style Play, the most appropriate pitch for the Upper part's tone is set automatically. If you want to change this, please refer to "Changing the Sound's Pitch by Octaves" (p.29).
- \* You can also change only the Style, while leaving the tone and tempo just as they are. Please refer to "Changing Arranger Settings" (p.61).

## When you want the entire keyboard to allow you to play chords —Piano Style Arranger

If you press the Part [Whole] button after pressing the One Touch Program [Arranger] button, the entire keyboard will be set to recognize the chords you play. You can perform Styles with the feeling of playing a regular piano, using both hands over the entire keyboard without having to worry about the split point. This function is called "Piano Style Arranger Play."

- \* When in Piano Style Arranger Play, you cannot use the Chord Intelligence function (p.38). Play chords using normal fingering.

### <<What is a Style?>>

There are many kinds of music throughout the world, each with its own characteristics. Jazz has a "Jazzy" feel, classical music seems "classical." You can say that the "mood" of any style of music is a combination of rhythm and tempo, instruments used, melody, and phrasing.

The sum of the elements that make up such a musical genre is called a Music Style.

With each Style, you can manipulate rhythm, bass, instruments that comprise the accompaniment, or even just enjoy playing around with the rhythms.

The KR-770 has been loaded with numerous internal Styles in order to allow you to perform in the mode of many of the world's various musical styles.

For more on how to select Styles, please refer to "Selecting Styles" (p.33).



## Selecting Styles

This unit comes with numerous internal Styles. The Styles are divided by genre into twelve groups. These groups are called “Style Groups.”

### Selecting a Style Group

**1. Press the Style Group button.**

The button’s indicator will go on, and the “Style Select screen,” like the one shown below, will appear in the display.



### Selecting a Style

There are numerous Styles in each Style group. After choosing a Style group, let’s choose a Style from the Style Select screen.

**2. Select a Style by pressing the buttons to the side of the display screen.**

The name of the Style selected will be highlighted in the display.

Try playing the keyboard to confirm that the tone indeed has been changed to the one you selected.

The Style Select screen is composed of multiple pages. Use the <Page ►►> and <◄◄ Page> buttons to bring up other pages to the screen.

**3. Let’s try Playing the Lower Keyboard**

When you press a key, the Style will begin to play.

- \* When you want to try out a number of different Styles from one Style group, pressing the [Hold] button will fix the Style Select screen in the display window, so it becomes unnecessary to press the same Style group button over and over, making this procedure very convenient.
- \* When you are in One Touch Arranger play, each time you change Styles, “Sync Start with Intro” goes into standby. (p.34)
- \* The number of Styles in each group varies. For a look at the number of Styles, Style names, etc., please refer to the “Style List” (p.75).
- \* When the Style is not playing, chord tones will be expressed when played on the Lower keyboard.

## Starting and Stopping Styles

Besides being able to start and stop Styles in the usual way, you can also start Styles with musical introductions (“intros”) and finish them up with special endings. Intros and endings with phrasing that best matches the selected Style are played.

You can also start a Style Playing when you press keys in the Lower (left hand) part. (p.34) This is called “Sync Start.”

- \* You can also select only a Style’s rhythm to play along with by starting the Style while the keyboard is not in Arranger mode.

### Start

#### Pressing the Button to Start

##### ● Starting with an Intro

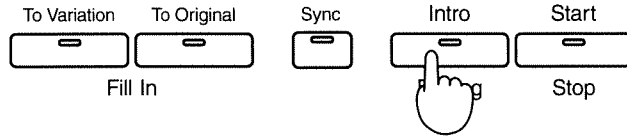

##### 1. Press the [Intro/Ending] button.

The Style, with intro, will begin playing.

During the intro, the [Intro/Ending] button's indicator will be lit, and when the intro is over, the indicator will go off.

##### ● Starting Without an Intro

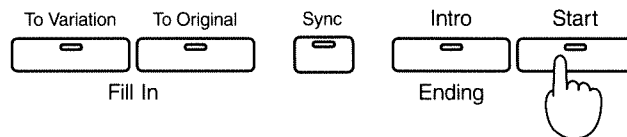

##### 1. Press the [Start/Stop] button.

The Style will begin playing.

#### Starting a Style By Playing Lower Keyboard (Sync Start)

##### ● Starting with an Intro

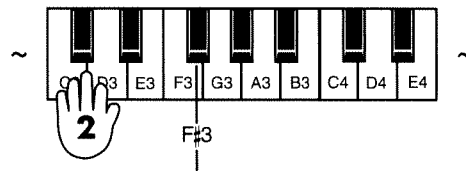
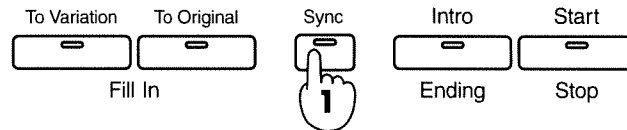

##### 1. Press the [Sync] button.

The [Sync] button's indicator will turn on, and the Beat Indicator and [Intro/Ending] button indicators will begin flashing.

##### 2. Play on the Lower Keyboard

The Style, with intro, will begin playing.

During the intro, the [Intro/Ending] button's indicator will be lit, and when the intro is over, the indicator will go off.

If you wish to cancel Sync Start, just press the [Sync] button once more.

#### <When You Want to Shorten/Simplify the Intro>

##### 1. Press the [Sync] button.

The button's indicator will be lit.

##### 2. Press the Fill In [To Original] button.

The button's indicator will begin flashing.

### 3. Play on the Lower keyboard.

The Style will play, beginning with a short intro.

#### ● Starting Without An Intro

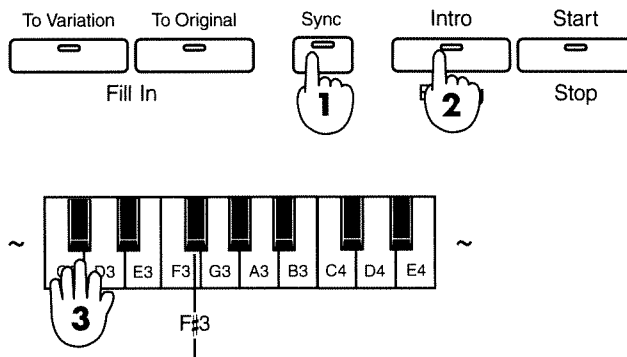

#### 1. Press the [Sync] button.

The [Sync] button's indicator will turn on, and the Beat Indicator and [Intro/Ending] button indicator will flash.

#### 2. Press the flashing [Intro/Ending] button, and the indicator will go off.

#### 3. Play on the Lower keyboard.

The Style will begin playing.

## Stopping

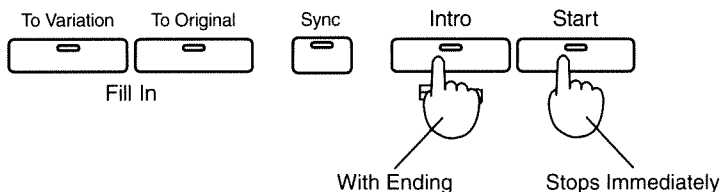

#### ● Stopping a Style With an Ending

##### 1. Press the [Intro/Ending] button.

During the ending, the [Intro/Ending] button's indicator will be lit, and when the ending is over, the indicator will go off.

#### <When You Want to Shorten/Simplify the Ending>

##### 1. Press the Fill In [To Original] button.

The button's indicator will flash.

##### 2. While the [To Original] button's indicator is flashing, press the [Start/Stop] button.

#### ● When You Want to Stop Immediately

##### 1. Press the [Start/Stop] button.

\* The number of measures in intros and endings varies with the Style.

\* Using the Pad button or the pedal, you can fade in (whereby the volume gradually increases) to the start of a Style, or fade out (whereby the volume gradually decreases) to the end of a Style. Please refer to "Registering Program Functions—The Pad buttons" (p.63) or "Changing How the Pedals Work" (p.64).

### Adjusting the Tempo of a Style

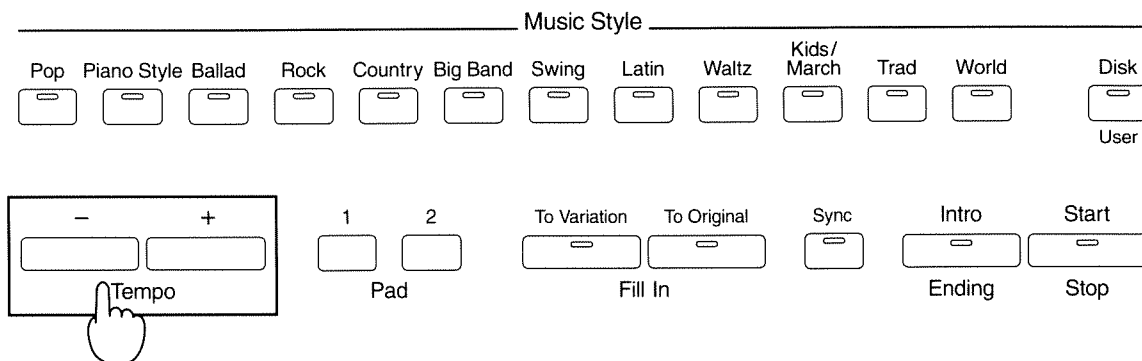

1. Pressing Tempo [+] speeds the tempo up, and pressing Tempo [-] slows it down. Tempo values are shown in the upper left part of the display. Additionally, you can confirm tempo and beat by looking at the Beat Indicator. Pressing the [+] and [-] buttons simultaneously will return the keyboard to the default standard tempo.

### Adjusting Accompaniment and Melody Volume Balance —The [Balance] Slider

You can adjust the balance of volume of the accompaniment and melody in the Upper keyboard.

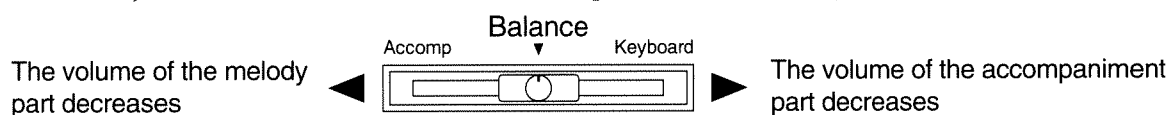

1. Adjust the volume balance with the [Balance] slider.

### Switching Style Arrangements

In each Style, you can select the particulars of the orchestration (arrangement) and accompaniment pattern type. You can do this before starting a Style, or you can make switches during performance of the Style.

#### Arrangement Type

There are two types of arrangement: Advanced and Basic.

The arrangement type is set to "Advanced" when power to this instrument is turned on.

Each time you press the button, you will toggle between Advanced and Basic Arrangement.

Advanced : more complex arrangement with more accompanying instruments.

Basic : simple arrangement with fewer accompanying instruments.

1. Press <Advnc < Basic> or <Advnc > Basic> on the Basic screen.

The correspondence between types of arrangement and what is shown on the display is as follows :

Screen	Arrangement Type
<Advnc < Basic>	Appears when Basic Arrangement is selected. Press <Advnc < Basic> to switch to Advanced Arrangement.
<Advnc > Basic>	Appears when Advanced Arrangement is selected. Press <Advnc > Basic> to switch to Basic Arrangement.

## Accompaniment Pattern Type

There are two types of accompaniment pattern: Original and Variation. The accompaniment pattern type is set to "Original" when power to the instrument is turned on.

Original : basic accompaniment patterns  
 Variation : altered accompaniment patterns

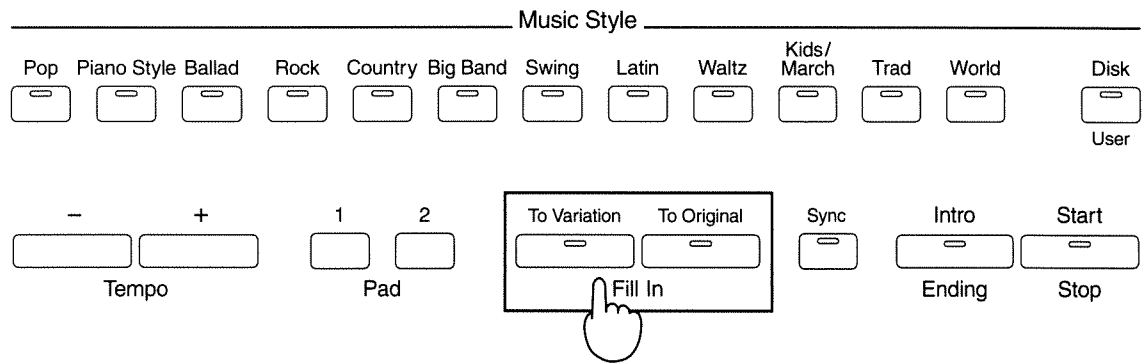

### 1. Press <To Variation> or <To Original> on the Basic screen.

The correspondence between types of accompaniment pattern and what is shown on the display is as follows:

<u>Button</u>	<u>Accompaniment Pattern Type</u>
[To Variation] button :	for Variation accompaniment patterns
[To Original] button :	for Original accompaniment patterns

Additionally, if you press these buttons during a performance, you can change the accompaniment by adding a slightly different performance. Such a performance is called a "fill-in." The Fill In feature adds phrasing most fitting for the selected Style.

When you press the button for the accompaniment pattern type other than the one selected, then the accompaniment pattern will switch after the fill-in has been inserted.

Using Original patterns for the quiet sections in the first part of a song, and Variations for the climaxes in the later sections is very effective.

- \* If you stop a Style when in One Touch Arranger, the accompaniment pattern will be set automatically to Original.

### Easy Fingering for Chords—Chord Intelligence

When performing a Style, you play chords in the left hand. Now you can play from seven representative chord types, even with the simplest fingerings.

For example, to play a “C” chord you ordinarily would need to press three keys: “C,” “E,” and “G.” However, on this instrument, you can get the chord to be sounded simply by playing the chord root “C”; you don’t have to play the other two notes. This function is called “Chord Intelligence.”

\* *Chord Intelligence is normally set to “On,” but you can turn the function off. Please refer to “Changing Arranger Settings” (p.61).*

How the keys are played is shown in the following table. In this table of the various keys to be played, “C” is the root. For other chords, please refer to the “Intelligent Chord List” (p.80).

- Major (□): Play the chord root. □: Chord root

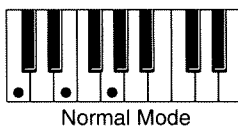
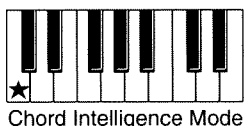

- Minor (□ m): Play the root and the third key above it.

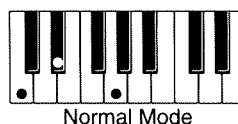

- Seventh (□ 7): Play the root and the second key below it.

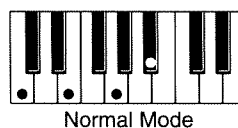
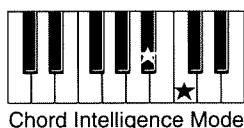

- Major Seventh (□ M7): Play the root and the first key below it.

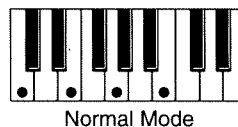

- Minor Seventh (□ m7): Play the root, the third key above it, and the second key below it.

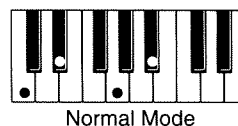

- Diminished (□ dim): Play the root and the sixth key above it.

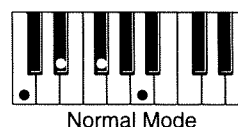

- Minor Major Seventh (□ mM7): Play the root, the first key below it, and the third key above it.

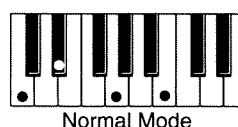

\* *Chords can also be selected by ordinary fingering, but the chord played and the chord recognized may be different, depending on the chord.*

## Using Style Disks

Besides the Styles that come built-in with the keyboard, there are additional Styles on the Style Disk included with this unit. These Styles are called Disk Styles. You can call up Disk Styles with the [Disk/User] button.

To find these Style names and numbers, please refer to the "Style List" (p.75).

\* Please note that if you select a Style from the Disk after calling up one of your own original Styles (User Styles) from the KR-770's memory bank, that Style you created will be erased! If you want to save your User Style, please refer to "Saving User Styles" (p.48).

### Calling Up Disk Styles with the [Disk/User] button

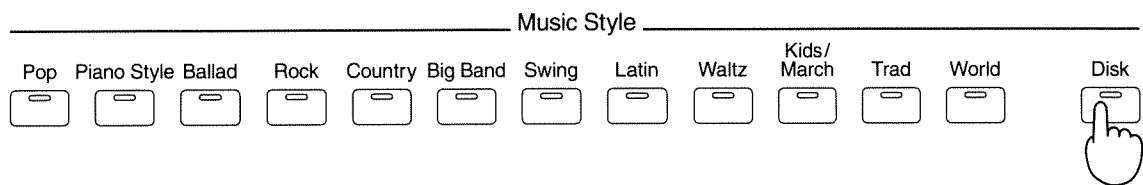

1. **Insert the Style Disk into the disk drive.**
  2. **Press the [Disk/User] button.**  
The Style name will appear in the display.
  3. **Using the buttons next to the display, select the Style you want to call up.**  
The name of the selected Style will be highlighted.  
After the reading of the disk into the keyboard's memory is finished, the [Disk/User] button's indicator stays on. The selected Style can now be called up with the [Disk/User] button.
  4. **Play the Lower keyboard.**  
The Style will begin to play.
- \* If the power is turned off, the Style called up with the [Disk/User] button will be erased. Also, when the power is turned on "Easy Listen" will be called up.
- \* When selecting a Disk Style, you cannot choose an Upper tone to fit a Style.

### When Selecting Styles Called Up with the [Disk/User] Button

1. **Press the [Disk/User] button.**  
The name of the Style called up with the [Disk/User] button will be shown in the display.
2. **Play the Lower keyboard.**  
The Style will begin to play.

### Adding Harmony to the Melody—The [Melody Intelligence] Button

Melody Intelligence is a function that automatically adds harmony to melodies played in the right hand.

These harmonies are based on the chords played on the Lower keyboard.

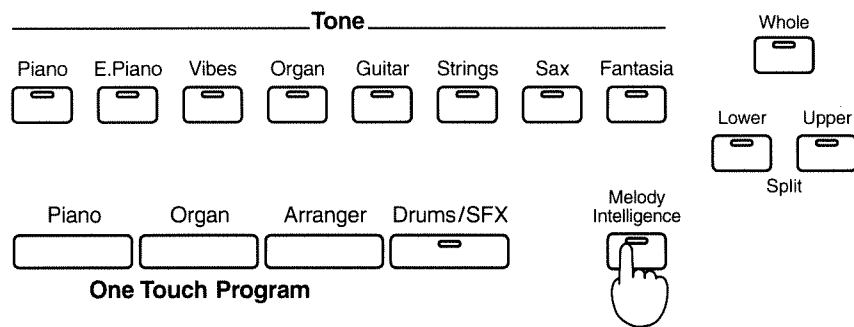

1. Using the [Melody Intelligence] button, switch Melody Intelligence on and off.

When you press the button and the indicator turns on, harmony will then be added to the melody.

A screen like the one shown below will appear in the display.



2. Using the buttons next to the display, select a type.

This screen is composed of five pages.

Use the <Page ►►> and <◀◀ Page> buttons to bring up other pages to the screen.

#### Melody Intelligence Types

Duet	Broadway
Organ	Gospel
Combo	Romance
Strings	Latin
Choir	Country Guitar
Block	Country Ballad
BigBand	Waltz Organ
Country	Octave Type 1
Traditional	Octave Type 2

After several seconds, the previous screen will return to the display.

- \* When "Full Auto" or "Tempo Lock" has been selected as the type of automatic settings for the Arranger (p.61), the type of Melody Intelligence that is set may vary, according to the Style.
- \* Among the Melody Intelligence types, some have tones which change automatically, or will sound in only a part of the Upper keyboard when played.



## Adjusting the Volume of Each Part—The Part Volume Buttons

The [Balance] slider adjusts the balance of the overall accompaniment volume and the that of the melody (Upper, Whole), but with the Part Volume button, you can adjust the volume of each part, or prevent a part from even sounding.

There are actually two buttons that comprise the Part Volume button: [Accomp] and [Keyboard].

The [Accomp] button is used to adjust the accompaniment volume, and the [Keyboard] button is for adjusting the volume of the keyboard being played.

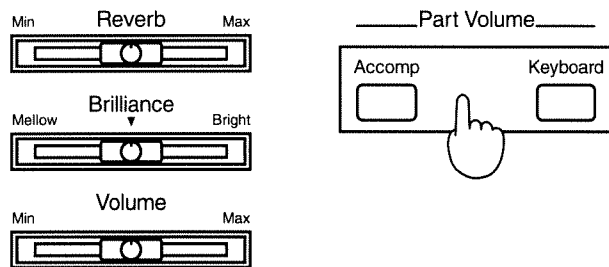

### When You Want to Adjust the Volume of the Rhythm, Bass, Accompaniment, or Chord Tone

1. Press the Part Volume [Accomp] button.

For each part, a bar graph and numerical value are displayed on the screen.

The correspondence between the parts and what is shown on the screen is as follows:

<Rhythm> .....Rhythm  
 <Bass>.....Accompaniment Bass and Bass Tone (P.61)  
 <Accomp>.....Accompaniment  
 <Chord> .....Chord Tone

2. Select the part you wish to adjust using the buttons below the screen.
3. With the <▲> and <▼> buttons, adjust the volume.  
 Pressing the <▲> button increases the volume, and pressing the <▼> decreases the volume.

### When You Want to Adjust the Volume of the Drums, SFX, Lower, Upper, or Layer

1. Press the Part Volume [Keyboard] button.

For each part, a bar graph and numerical value are displayed on the screen.

The correspondence between the parts and what is shown on the screen is as follows:

<Drs/SFX>.....Drums and SFX  
 <Lower> .....Lower  
 <Layer> .....Layer  
 <Upper> .....Upper

2. Select the part you wish to adjust using the buttons below the screen.
3. With the <▲> and <▼> buttons, adjust the volume.  
 Pressing the <▲> button increases the volume, and pressing the <▼> decreases the volume.

# 2-3 Recording and Playback

## Recording Performances (Normal Recording)

This unit comes with "Composer," a feature which functions like a tape recorder. So you can record your own performances, as well as play performances using commercially available music data. You can store one song at a time. When you record a song, the performance data is automatically separated and recorded onto five separate tracks.

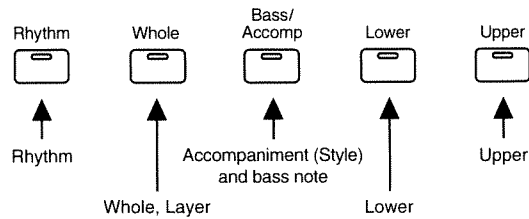

### <<What is a Track?>>

On devices like tape recorders, sounds that are played back on the left speaker and those that are played back on the right speaker are recorded onto separate places on the tape. These separate "places" where this sort of recording of material is done are called "tracks."

## Let's Try Recording Something

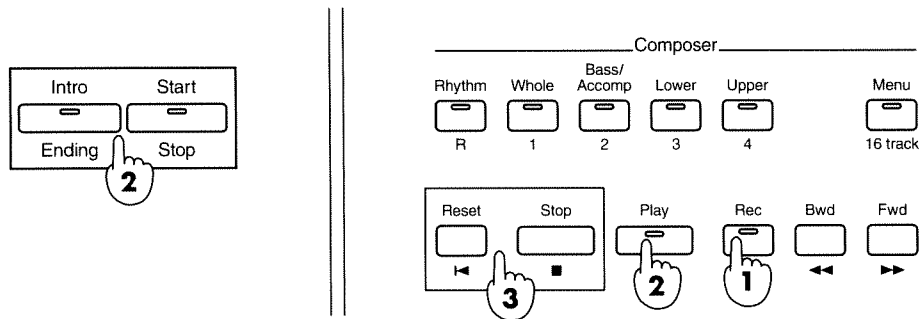

### 1. Press the [Rec] button.

The recording function goes into standby mode.

The [Rec] button's indicator will be on, and the [Play] button's indicator will begin flashing.

Once again, the tracks onto which the performance is recorded are selected automatically, and the track button's indicator will flash when it is recording.

Only when in Whole Keyboard mode you can record any track except the Rhythm. In that case, the track whose button was the last one pressed will be recorded.

- \* If a disk has been inserted in the disk drive, or after a disk performance has finished, then when you want to record your own performance, press the [Song] button, and the Song Select screen will appear on the display. Select <U : User Song> at the upper left of the display, and after that press the [Rec] button, and operation 2 will begin.

### 2. Begin recording.

When you are ready to record a Style performance . . . start the Style, and recording begins.

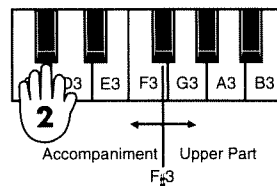

At other times—press the [Play] button. Two measures of count-in will sound, after which recording will begin.

When recording begins, the [Play] button's indicator changes from a flashing to a constant light.

### 3. When the performance is finished, press the [Stop] or [Reset] button.

The indicator on the button for the track on which the performance was recorded will change from a flashing to a constant light.

- \* Recording will also stop if, while a Style is playing, you stop the Style by pressing either the [Intro/Ending] button or the [Start/Stop] button.
- \* You can also set it so recording can be continued after the ending of a performance. Please refer to "Changing the Recording Method" (p.51).
- \* While there is a performance in the KR-770, you will be unable to select songs from a disk. After either saving the recorded performance to disk (see p.46) or erasing the performance (see p.46), you will then be able to select songs from the disk.
- \* You cannot add multiple DSP effects simultaneously, so when recording on multiple tracks while overdubbing a performance, or when playing a performance along with the playback of a song, you may encounter times when you won't be able to add effects.

### <Cautions to Take After Recording>

If, after recording, the power is turned off, the recorded performance will be erased.

When you want to save performances you've recorded, please refer to "Saving Recorded Performances to Disk-Save" (p.46).

### If You Make a Mistake in a Performance

With the process described below, you can fix your recordings.

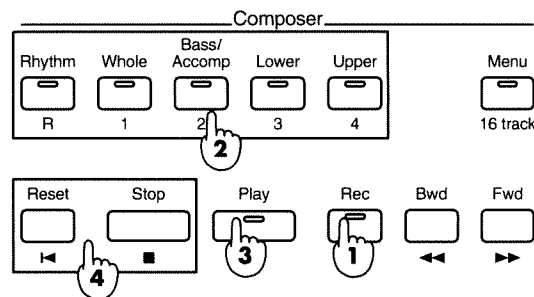

#### 1. Press the [Rec] button.

The button's light will go on.

#### 2. Press the button for the track you want to fix.

The track button's indicator and the [Play] button's indicator will flash.

#### 3. Press the [Play] button.

Two measures of count-in will sound, after which recording will begin.

#### 4. When the performance is ended, press the [Stop] button or the [Reset] button.

If you want to cancel the operation during recording, press the [Stop] button.

- \* When the re-recorded performance is shorter than the original, previous version, that previous version will remain. If you want the previous performance to be completely erased, please re-record after erasing the previous version. Please refer to "Erasing Recorded Performance" (p.46).
- \* If you want to start recording somewhere other than at the beginning, then, using the [Bwd] and [Fwd] buttons, go to the measure where you will start recording, and press the [Rec] button. Press the [Play] button, recording will begin after two measures of the count-in sounding.
- \* Normally, during the re-recording process, a previous performance which has been recorded over is erased, but you can, without erasing that performance, layer the two recordings. Please refer to "Changing the Recording Method" (p.51).

### Playing Back Recorded Performances

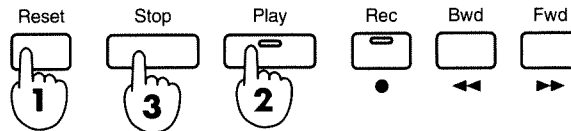

1. **Press the [Reset] button.**  
This will “rewind” you to the beginning of the performance.
  2. **Press the [Play] button.**  
The recorded performance will begin to play.  
You can play after advancing to later measures or returning to previous ones.
  3. **The song stops automatically when the performance is finished.**  
To stop while the performance is running, press the [Stop] or the [Reset] button.
- \* *By pressing the [Play] button while holding down the [Stop] button, you can have the performance play back after two measures of metronome count.*

### Temporarily Muting Sounds on Specific Tracks (Track Mute)

After selecting specific tracks, you can temporarily prevent those tracks from sounding, or “mute” them.

In instances such as when you might want to play just one part of a song on a commercial music disk, just mute the track for that part. This playing in place of the recorded, but muted part is called “Minus-One Play.” You can also record your Minus-One Play. Please refer to “Recording Minus-One Play” (p.44).

1. **Press the button for the track you wish to mute.**  
The button’s indicator will go out.  
When the button’s indicator for any track is out, that track’s sound will not be played back.  
When you press the track button once more, the button’s indicator will turn on again, and the sound on that track will be played back again.

### Recording Minus-One Play

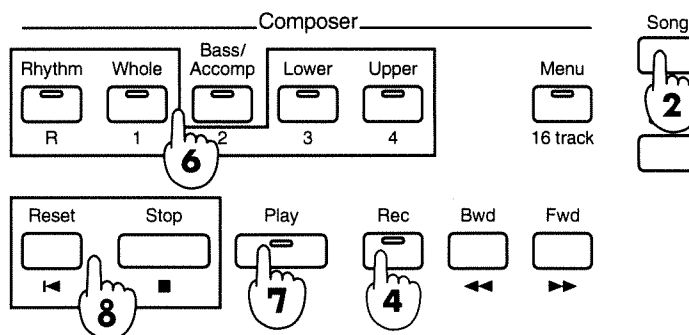

1. **Insert a music data disk into the disk drive.**
2. **Press the [Song] button.**  
The Song Select screen will appear on the display.
3. **With the buttons located to the side of the display, select a song.**

4. **Press the [Rec] button.**  
The button's indicator will turn on.
5. **Since the track which a performance is to be recorded on is determined according to its current status, make your choice from the following performance status list based on the track on which you want to record.**

<u>Desired Track</u>	<u>Operation</u>
[Whole]	After pressing the One Touch Program [Piano] button, select Whole Keyboard Play.
[Lower], [Upper]	After pressing the Part [Lower] button, select Split Play.
[Rhythm]	After pressing the [Drums/SFX] button, select Drums or SFX performances.

- \* *You cannot record using the [Bass/Acomp] track.*
  - \* *If you select a track other than the ones shown above, nothing will be recorded on that track. Additionally, whatever performance already on that track will be erased.*
6. **Press the button for the track onto which you want to record.**  
The button's indicator will start flashing.
  7. **Press the [Play] button.**  
Two measures of count-in will sound, and then recording will begin.
  8. **When the performance is ended, press the [Stop] button or the [Reset] button.**  
When you stop recording of the performance, the button's indicator for the track you were recording on will change from a flashing to steady light.
- \* *When saving Minus-One Play you have recorded to disk, please refer to "Saving Recorded Performances to Disk—Save" (p.46). Due to copyright protection, you may not be able to save from some commercially available music data disks.*
  - \* *When recording using music data performances, if you record in [Whole] track mode, the tone in the Lower and Upper keyboard you are playing may change to the recorded tone.*

### Playing Back Performances Without Changing the Tempo

There are songs on some music data disks where the tempo changes, adding swelling pulse to the song. When you use this kind of song in a Minus-One Play, you may find it difficult to follow these tempo changes. For that kind of situation, let's try keeping the tempo from changing during playback.

1. **While holding down the Composer [Stop] button, press either the Tempo [+] or [-] button.**  
The tempo will be highlighted in the display.
- \* *If at this point you select another song, or carry out the above step one more time, you will be returned to playback with changing tempo.*

## 2-3 Recording and Playback

### Erasing Recorded Performances

Erase the performance you recorded.

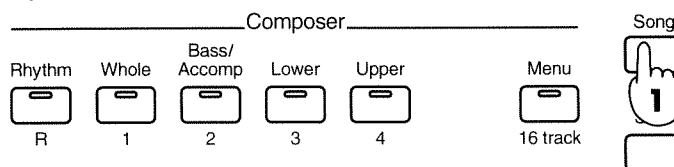

**1. Press the [Song] button.**

A message will appear in the display, asking you to confirm that you want to erase the performance, if you have not saved the performance on the disk yet. When you want to erase the data, press <OK>.

If you want to cancel the operation, press <Cancel>.

After the performance has been erased, the Song Select screen will appear in the display.

**2. Press <U : User Song> at the upper left of the display.**

### Saving Recorded Performances to Disk-Save

Recorded performances are erased when the power is turned off. When you want to keep a performance, please use the method shown below. This process of saving performances you have recorded is known simply as "Save."

The number of songs that can be saved onto a disk depends on the amount of performance data they contain, but the maximum number of songs you can save is ninety-nine songs.

\* *New disks or disks which have been used on other equipment cannot be used just as they are. Please refer to "Using New Disks-Formatting" (p.51).*

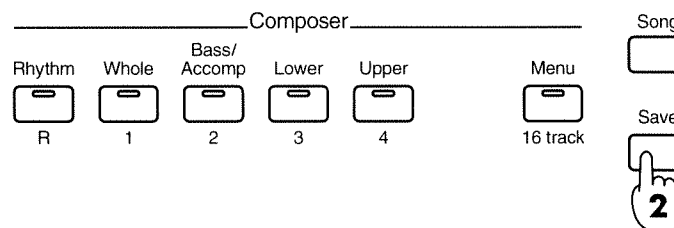

**1. Insert a disk you want to record on into the disk drive. Make sure the write protect tab is set to "Write" (p.8).**

You can save onto the following disks:

- New disks formatted on this machine.
- Disks on which performances recorded on this machine are saved.

**2. Press the [Save] button.**

A screen like the one shown below will appear in the display.

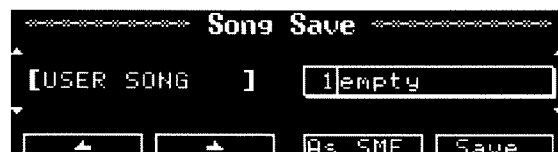

**3. With the <▲> and <▼> buttons to the right of the screen, add a song number.**

You can choose from numbers 1-99. Numbers previously entered on the disk will be highlighted. Selecting one of these numbers will cause the previous one to be overwritten.

4. Choose a name for the performance with <◀> and <▶> below the screen and the <▲> and <▼> buttons to the left of the screen.

The characters you can use to do this are listed below:

Blank ! " # \$ % & ' ( ) \* + , - . / 0 1 2 3 4 5 6 7 8 9 : ; < = > ? @  
 A B C D E F G H I J K L M N O P Q R S T U V W X Y Z [ \ ] ^ \_  
 ` a b c d e f g h i j k l m n o p q r s t u v w x y z { } | ~

5. When it is all right to do the save, press <Save>.
 

If you are going to listen to the saved performance, please refer to "Let's Listen to Some Music Data-Playing Back Disk Performances" (p.24).  
 If you want to cancel the save, press [Exit].

\* If you get an error message sometime during the procedure, please refer to the "Error Message List" (p.78).

### Saving After Converting Data to SMF Format

In some cases you will not be able to play back performances on other instruments in the same form that they were recorded on this instrument. In such cases, by converting the performances recorded on this unit to the widely-used SMF data format, you will then be able to play them back on other instruments.

The number of songs that can be saved onto a disk depends on the amount of performance data they contain.

1. When the performance you want to convert is on a floppy disk, insert the disk into the disk drive.
 

After you press the [Song] button, the Song Select screen will appear in the display. Select a performance, and press the [Play] button to start playback.
2. Substituting SMF Data Disks.
 

You can save onto the following disks.

  - New disks formatted on this machine;
  - Disks on which performances recorded on this machine are saved.
3. Press the [Save] button.
4. Select a number with <▲> and <▼> to the left of the screen.
 

You can choose from numbers 1-99. Numbers previously entered on the disk will be highlighted. Selecting one of these numbers will cause the previous one to be overwritten.
5. Choose a name for the performance with <◀> and <▶> below the screen and the <▲> and <▼> buttons to the left of the screen.
6. When you press <As SMF> on the screen.
 

If you want to cancel the operation, press the [Exit] button.

\* You cannot convert performances other than those recorded on this instrument.

\* You can play back performances on other instruments using the GS format. However, depending on the GS Format instrument you use, expression numbers may be insufficient, and the sounds themselves may differ.

\* If you get an error message sometime during the procedure, please refer to the "Error Message List" (p.78).

\* Due to copyright protection, you may not be able to save as SMF format from some commercially available music data disks.

\* If you are going to use disks formatted with this instrument on other instruments, prevent accidental overwriting by setting the disk's write protect tab to "Protect."

### Saving User Styles

You can save User Styles (see p.52) onto floppy disks. You can call up Styles that have been saved to disk in the same way you do with Style disks.

**1. Insert the disk with your User Styles saved on it into the disk drive.**

You can save onto the following disks:

- New disks formatted on this machine;
- Disks on which User Styles created on this machine are saved.

**2. Press the [Disk/User] button from Style Group.**

The Style Select Screen will appear in the display.

**3. Press <Save>.**

**4. Select a number with the <▲> and <▼> buttons to the left of the screen.**

You can choose from numbers 1-99. Numbers previously entered on the disk will be highlighted. Selecting one of these numbers will cause the previous one to be overwritten.

**5. Choose a name for the performance with the <◀> and <▶> below the screen and the <▲> and <▼> buttons to the left of the screen.**

Please refer to "Saving Recorded Performances to Disk" (p.47) for the list of characters you can use to designate performances.

**6. When it is all right to do the save, press <Save>.**

\* *If you want to cancel the operation, press [Exit] button.*

\* *You can call up Styles that have been saved to disk in the same way you do with Style disks. Please refer to "Using Style Disks" (p.39).*

\* *Depending on the Style, saving may take considerable time.*



# 3-1 Composer Menu

## Operating of the Composer Menu

### 1. Press the Composer [Menu] button.

A "Composer Menu screen" such as the following appears on the display.



You can choose from the seven types of function on the Composer menu.

#### 16trk Sequencer (p.49)

You can achieve multiple-voice recording that uses 16 tracks.

#### Chord Sequencer (p.50)

You can input chords one at a time to create the accompaniment.

#### Recording Mode (p.51)

This changes the recording method.

#### Disk Format (p.51)

This formats a floppy disk.

#### Style Composer (p.52)

You can combine a Style with each part.

#### Style Converter (p.53)

This creates a Style from the performance data.

#### Song Edit (p.54)

This edits the performance data.

### 2. Use the buttons next to the display to select the function.

The Composer Menu screen has two pages.

Use <Page ▶▶> and <◀◀ Page> to bring up the other page.

To cancel the operation, press the [Exit] button. The display then returns to the original screen.

## Recording Multiple Voices —16 Track Sequencer

The Composer on the KR-770 has a built-in "16 Track Sequencer" that can record multiple voices using 16 tracks. You can use this 16 Track Sequencer to record performances for up to 16 instruments, overlaying them Part by Part, to create a single song. Because 16 Track Sequencer records the performance for a single type of Tone on one track, it cannot be used to record Split or Layer Play.

### 1. At the Composer Menu screen, press <16trk Sequencer>.

The "16 Track Sequencer screen" such as the following appears on the display.



The Part [Whole] button also lights up and the KR-770 is set up for Whole Keyboard performance.

### 2. Use <◀> and <▶> to the lower right of the display to choose the track you wish to record.

The currently selected track appears in reverse video on the display.

\* Drum or SFX performances can only be recorded on the "D" or "S" tracks.

### 3. Get ready to play.

Choose the Tones and make the necessary settings for the performance.

You can use <VOL+> and <VOL-> to the left of the display to set the volume level for each track.

\* To regist the volume, press the [Reset] button while holding the [Rec] button.

### 4. Press the [Rec] button, then press the [Play] button.

Two bars are counted down, and after that recording starts.

### 5. Press the [Stop] button to stop recording.

A "□" appears next to the track that was recorded.

### 6. Repeat steps 2, 3, 4, and 5 to record each track.

You can delete the data for a selected track by pressing the <CLR>.

If you want to start recording while a performance is in progress, use the Composer [Fwd] and [Bwd] buttons to move to the desired measure.

## Muting or Playing Selected Track

### <Mute>

Choosing a track and pressing <Mute> causes the performance for that track to be muted out. A "□" of dotted lines appears on-screen next to the muted track. Each press of the <Mute> toggles muting on or off.

### <Solo>

Choosing a track and pressing <Solo> causes only the performance for that part to be heard. Each press of the <Solo> toggles solo play on or off.

## 3-1 Composer Menu

\* Different types of DSP effects cannot be applied to more than one part, so DSP effects may not be applied correctly when a multiple-voice performance is recorded on a number of tracks.

\* The relationship between tracks and MIDI channels is as follows.

Track	1	2	3	4	5	6	7	8	9	D	S	12	13	14	15	16
MIDI channel	1	2	3	4	5	6	7	8	9	10	11	12	13	14	15	16

\* When using 16 Track Sequencer, the Composer's five Track buttons do not function.

\* Set the beat of the Metronome before recording with 16 Track Sequencer. The performance that you record uses the Metronome setting in effect before 16 Track Sequencer is used.

### Using the Chord Sequencer Function

Using the Chord Sequencer function makes it possible to create an accompaniment simply by entering the chord progression one chord at a time. By using Chord Sequencer to create the accompaniment ahead of time, then playing the melody along with the accompaniment you've created, you can create a Style performance simply even if playing chords is not your strong suit.

#### 1. Press <Chord Sequencer> at the Composer Menu screen.

A "Chord Sequencer Screen" like the one below appears on the display.

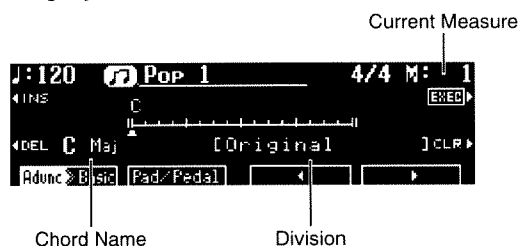

(\* For more information on divisions, check out "Muting Selected Parts for Each Division" (p.53).)

#### 2. Use the Style Group buttons to choose a Style.

After several seconds, the display returns to the Chord Sequencer screen.

#### 3. Use <INS> to insert the desired number of blank measures in the song you wish to input.

4. Use the <◀> and <▶> at the bottom right of the display or the [Bwd] and [Fwd] button to move the cursor (▲) to the position where the chord and division are to be input.

#### 5. To enter a chord, play the chord on the lower keyboard.

The chord display above the measure serves as a guide for entering chords. Check out the chords next to the division display for the actual chord.

Entry item :      Operation

#### Entering an Intro or Ending:

Press the [Intro/Ending] button.

#### Changing the Arrange type:

Press <Advnc ▶ Basic> (or <Advnc ◀ Basic>).

#### Entering a Fill-in:

Press the Fill In button.

(If you assign the functions to pads or pedals, you can also enter divisions such as "Break.")

You can insert and delete measures by pressing <INS>, <DEL>, and <CLR> next to the display.

#### <INS>

Inserts a single blank measure at the position of the cursor.

#### <DEL>

Deletes a single measure after the position of the cursor, and shifts all the bars beyond by one measure.

#### <CLR>

Deletes the information (chords and divisions) at the position of the cursor.

\* When entering a fractional chord such as "Fm/C", the Leading Bass function is used.

Take a look at "Registering Program Functions" (p.63) for more information on Leading Bass.

#### 6. Press the Composer [Play] button to check what's been done.

The accompaniment you've created is played, starting from the position of the cursor.

Press the Composer [Stop] button to stop the performance.

#### 7. When you've finished inputting the accompaniment, press <EXEC> at the right-hand side of the display.

After several seconds, the display returns to the Composer Menu screen.

#### 8. Press the Composer [Play] button.

The accompaniment you've created is played, so try playing the melody along with the accompaniment as backing.

\* Once <EXEC> has been pressed, what you've input cannot be done over. Make sure everything has been entered correctly before you press <EXEC>.

\* An Intro can only be input at the start of a song.

\* Entering an Intro causes a number of measures corresponding to the Intro's length to be inserted automatically.

## Changing the Recording Method —Recording Mode

You can select the recording method and the way that recording is stopped.

1. At the Composer Menu screen, press <Recording Mode>.

A screen like the one below appears on the display.



2. Use the buttons on the left side of the display to select the recording method (Rec Mode) and use the buttons on the right side of the display to select how recording ends.

### Recording Method (Rec Mode)

#### Replace :

This is the usual recording mode. When a performance is recorded on a specified track, recording progresses as the performance is deleted. This method is called "Replace Recording" (default setting).

#### Mix :

This records over a previously recorded performance. This method is used when recording overtop the same track. It is used at times such as when recording overtop a drum performance to create a rhythm part. This method is called "Mix Recording."

#### Punch In/Out :

During playback of a performance, you can press a pedal (or a Pad button) at the desired spot to begin recording. Pressing the pedal (or the Pad button) again cancels recording and returns to the playback state. This can be used to re-record a certain passage. This method is called "punch-in recording."

Punch-in recording can only be performed when "Punch In/Out" has been set as the pedal (or the Pad button) function. To perform recording, be sure to set the pedal function before you start. Check out "Changing How the Pedals Work" (p.64) "Registering Program Functions—The Pad Buttons." (p.63) for more information on pedal and Pad button settings.

\* *Punch-in recording erases the previously recorded performance as it records.*

### Method of Stopping (Rec Stop)

#### Arranger Stop :

When the Arranger stops, recording ends at the same time.

#### Composer Stop :

Pressing the Composer [Stop] button ends recording. Recording can be continued until the Composer [Stop] button is pressed, even after the Style ends.

## Using New Disks—Formatting

In order to use new disks or disks which have been used on other equipment, it will be necessary to "format" such disks.

\* *When a disk is formatted, all the data stored on it is completely erased. Be absolutely sure that it is acceptable to format the disk before you carry out the process.*

1. After confirming that the write protect tab on the disk you are going to format is in the "Write" position (see p.8), insert the disk into the disk drive.

2. Press <Disk Format> on the Composer Menu screen.

A screen like the one shown below will appear in the display.



3. If you want to proceed with the format, press <OK>.

When the format begins, a countdown will begin on the screen.

If you want to cancel the operation, press the <Cancel> shown on the screen, or press the [Exit] button.

\* *If you get an error message sometime during the procedure, please refer to the "Error Message List" (p.78).*

\* *During formatting, do not try to remove the disk from the disk drive. Doing so may result in damage.*

### Using Built-in Styles to Create Your Own Style—Style Composer

A built-in Style is made up of five Parts: “Rhythm,” “Bass,” “Accompaniment 1,” “Accompaniment 2,” and “Accompaniment 3.”

The KR-770 has a function called “Style Composer” that lets you combine the Parts from different Styles to create your own Style. A Style made with this Style Composer is called a “User Style.”

The tempo of a User Style is established by the Rhythm part’s Style tempo. When you wish to change the tempo, press the [Tempo] button to adjust.

\* A User Style is deleted when the power is turned off. If you want to save a User Style, check out “Saving User Styles” (p.48).

#### 1. At the Composer Menu screen, press <Style Composer>.

The rhythm for the currently selected Style is played back, and a screen like the one below appears on the display.



The Part names are displayed at the center of the screen. The Part that appears in reverse video is the currently selected Part.

\* The Track buttons correspond to the Parts as follows.

Part	Display	Track button
Rhythm	R	[Rhythm]
Bass	Bass	[Bass/Acomp]
Accompaniment 1	A1	[Lower]
Accompaniment 2	A2	[Upper]
Accompaniment 3	A3	[Whole]

#### 2. Use the Style Group buttons and the buttons next to the display to choose the desired rhythm Style.

Every time you change the Style, the rhythm that is played back changes.

After several seconds, the display returns to the Style Composer screen.

#### 3. After you’ve chosen the rhythm, use <◀> and <▶> at the lower right the display to choose the Part you wish to change.

You can also choose a Part by pressing the Track buttons.

The Part sound you select here is added to the Rhythm you chose earlier, and the result is played back.

#### 4. Repeat steps 2 and 3 to make the settings for each Part.

You can use <VOL+> and <VOL-> to the left of the display to set the volume level for each track.

#### 5. After you’ve decided on the Style, press the <EXEC> button.

The User Style is saved to the [Disk/User] button.

You can also use the Composer [Rec] button to save.

To stop the operation, press the [Exit] button.

\* You can press <Advnc ▶ Basic> (or <Advnc ◀ Basic>) at the lower left of the display to change the Arrange type.

\* Only certain types of data can be assigned to a Part for each Style. For example, you can’t assign a bass Part to “A1.”

\* Depending on the Style and division, some Parts may not contain data.

\* Combining of parts can only be done with internal style.

### If You Want to Remake a User Style

\* Take a look at left chart for the correspondences between Track buttons and Parts.

#### 1. At the Composer Menu screen, press <Style Composer>.

The User Style is played back and the Track button’s indicators that correspond to the Parts light up.

#### 2. Use <◀> and <▶> at the bottom of the display to choose the Part on screen that you wish to revise.

You can also choose the Part to be revised by pressing the corresponding Track button to make the button’s light come on.

#### 3. Use the Style Group buttons and the buttons next to the display to choose the desired Style.

Every time the Style is changed, the Parts that are played back change.

#### 4. Use <◀> and <▶> at the bottom of the display to choose the next Part to be changed.

#### 5. Repeat steps 2, 3, and 4 to make the settings for each of the Parts.

Pressing the <CLR> button causes the Part being selected not to be heard.

#### 6. After you’ve decided on the Style, press the <EXEC> button.

You can also save the Style by pressing the Composer [Rec] button.

### Muting Selected Parts for Each Division

"Division" is a word that refers to the state of play. Here are the six divisions that exist during Style Play.

- **Intro** When the intro is being played
- **Original** When an original accompaniment pattern is being played
- **Variation** When a variation accompaniment pattern is being played
- **Fill-in to Variation** When a fill-in to variation is being played
- **Fill-in to Original** When a fill-in to original is being played
- **Ending** When the ending is being played

With the KR-770, you can silence (mute out) selected Parts for each division of a User Style.

Example :

Muting out Accompaniment 1 when playing a variation accompaniment pattern.

#### 1. At the Composer Menu screen, press <Style Composer>.

The User Style is played back and the Track button indicators that correspond to the Parts light up.

#### 2. Press the Fill In [To Variation] button to make the setting for a variation accompaniment pattern

(That makes this the division to be muted).

If the division is one that changes after a few seconds (Intro, Ending or Fill-in), carry out the next step while the division is in effect (for example, while the intro is being played).

#### 3. Use <◀> and <▶> at the bottom of the display to choose "A1" then press <Mute>.

(Use <◀> and <▶> at the bottom of the display to choose the Part you wish to mute out, then press <Mute>.)

Accompaniment 1 is muted, and the light for the Track [Upper] button's indicator goes out.

Muting is toggled on or off each time you press <Mute>.

Another way to perform muting is to hold down Composer [FWD] button and press the Track button that corresponds to the Part you wish to mute out. In this case, each press of the Track button toggles between playback (light lit) and muting (light dark) of the Part.

#### 4. After you've decided on the Style, press the <EXEC> button.

You can also register the Style by pressing the Composer [Rec] button.

## Creating an Original Style —Style Converter

The KR-770 has a function for cutting out part of a performance and creating a new Style. This function is called "Style Converter."

Using Style Converter, you can make your own original Styles from performances created with 16 Track Sequencer.

#### 1. Use 16 Track Sequencer to record a performance of "Major," "Minor," or "Seventh" type.

\* Take a look at p.49 for an explanation of how to use the 16 Track Sequencer.

Because only certain tracks can be handled as Style data, you should record the performance on the following tracks.

Track	Style Part
2	Bass
7	Accomp1
8	Accomp2
9	Accomp3
D	Rhythm

If you're creating a Style with many changes, it's probably a good idea to give attention to divisions such as the Intro, Fill-ins, and Ending as you record.

#### 2. At the Composer Menu screen, press <Style Converter>.

A screen like the one below appears on the display.



#### 3. For each division, select the bars to be cut out, key, chord type, and other settings.

Use <◀> and <▶> at the bottom of the display to choose the items to be set, and use the buttons on the left to change the settings.

Press <CLR> to disable a setting.

- Division :** Type of accompaniment pattern
- From :** Starting measure to cut out of the performance
- For :** Number of bars from the starting measure
- Key :** Key of the cut-out performance
- Chord :** Chord type of the cut-out performance (Select Major, Minor, or Seventh.)

#### 4. Press the [Play] button to listen to the cut-out portion.

The performance is played back.

## 3-1 Composer Menu

5. After you've checked all the divisions that you want to make settings for, press <EXEC>.

The Style is saved to the [Disk/User] button.

\* For information on divisions, see p.53.

\* Only certain tracks can be handled as Style data. If the performance has been recorded with the Composer, or if the performance data is not on the specified tracks, use Track Exchange at the Edit screen to change the tracks. Take a look at "Swapping and Copying Tracks—Track Exchange/Track Copy" (p.57).

\* If "Fill to Variation" or "Fill to Original" has been chosen for "Division", only one measure can be cut out.

\* Preset selections are used for divisions which are not selected.

\* The following are recommended as data which can be handled as Style data. Including data other than any of these may produce unexpected results.

- Performance information from the keyboard
- Reverb Depth
- Chorus Depth

\* Once the <EXEC> has been pressed, the previous settings cannot be recovered.

### Editing a Recorded Performance —Song Edit

The KR-770 has eight functions that you can use to edit the performances that you've recorded.

#### Note

Once editing has been performed, it may not be possible to go back to the state of things before editing, or the settings that have been made may produce unwanted results. Performances that use Arranger in particular may end up with an accompaniment that is strange and inappropriate. We recommend that you save your performance to disk before editing it.

#### Steps for Editing

1. At the Composer Menu screen, press <Song Edit>. An "Edit screen" like the one below appears on the display.



2. Use the buttons next to the display to choose the editing function.

The Edit screen has two pages.

Use <Page >>> and <<< Page> to bring up the other page.

For information on the steps for the functions described, refer to the pages that are listed for each one.

1. Changing the Tempo and Volume of a Performance—Set up (p.54)
2. Aligning Imperfect Notes—Quantize (p.55)
3. Erasing a Performance—Erase (p.56)
4. Copying a Measure—Copy (p.55)
5. Deleting a Measure—Delete (p.56)
6. Inserting a Blank Measure—Insert (p.56)
7. Changing the Key—Transpose (p.56)
8. Swapping and Copying Tracks—Track Exchange/Track Copy (p.57)

\* To stop an operation, press the [Exit] button.

#### Editing a Performance Saved on Disk

Insert the disk in the disk drive and play back the performance one time. Then edit it.

#### Changing the Tempo and Volume of a Performance—Setup

Changing the Tempo and Volume of a Performance—Setup

1. Before going into the Song Edit screen, set the tempo by pressing the Tempo button, and set the volume of track you want to change in the 16 Track Sequencer screen.

2. Press <Setup> from the Edit screen. The display will change, and a screen like the one shown below will appear.



3. Press <Execute>. The tempo and volume of the recorded performance are changed.

\* After step 1, you can also change the setting by pressing the [Reset] button while holding down the [Rec] button.

\* Changes in the tempo and volume that are made by pressing the Tempo buttons and Part Volume buttons, or using the [Balance] slider are only set temporarily. You can't change the original tempo and volume of the recorded performance this way.

## Aligning Imperfect Notes—Quantize

You can take a performance to correct recorded notes to the specified timing. This is called “quantizing.” For instance, say that you wanted to record with quarter-note timing, but the actual timing was a little off—slightly ahead or late. In this case, you can quantize with quarter-note timing (1/4) to produce timing that is accurate.

### 1. Press <Quantize>.

A screen like the one below appears on the display.

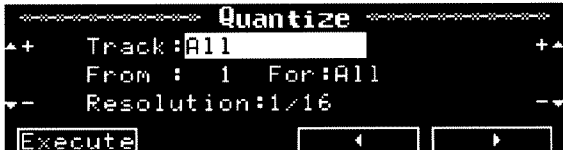

### 2. Use <◀> and <▶> at the bottom of the display to choose the item, then use <+> and <-> next to the display to select the value.

**Track :** Track number

Selecting “All” chooses all tracks.

**From :** The starting measure

**For :** The number of bars from the starting measure

Selecting “All” chooses everything from the starting measure to the end of the song.

**Resolution :** Timing at which the notes are to be organized. Select the length of the shortest note occurring in the performance data to be quantized (or an even shorter length).

### 3. When you’ve finished making the settings, press <Execute>.

## Erasing a Performance—Erase

Erase is a function that erases a portion of the selected song, making the erased area blank.

This operation works like a rubber eraser to erase written notes from a score.

\* *Once notes have been erased, they cannot be restored.*

### 1. Press <Erase>.

A screen like the one below appears on the display.

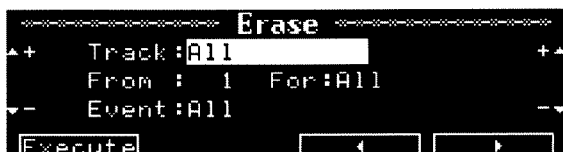

### 2. Use <◀> and <▶> at the bottom of the display to choose the item, then use <+> and <-> next to the display to select the value.

**Track :** Track number

**From :** The starting measure

**For :** The number of bars from the starting measure. Selecting “All” chooses everything from the starting measure to the end of the song.

**Event :** Type of data to be erased

“All” : All data

“Note” : Keyboard performance data (information when the keyboard is played)

“Except Note” : Data other than keyboard performance data (information on the damper pedal, soft pedal, etc.)

“Tempo” : Tempo data (changes in tempo in the performance)

Tempo changes occurring during the performance disappear, and the initial tempo remains constant throughout the song.

\* *Selecting “Tempo” as the Event erases all tempo data, regardless of what Track numbers have been selected.*

### 3. When you’ve finished making the settings, press <Execute>.

## Copying a Measure—Copy

This copies a portion of a performance to another bar on the same track. This is used when you want to repeat a similar phrase.

\* *Any performance existing at the copy destination is overwritten by what is copied.*

### 1. Press <Copy>.

A screen like the one below appears on the display.

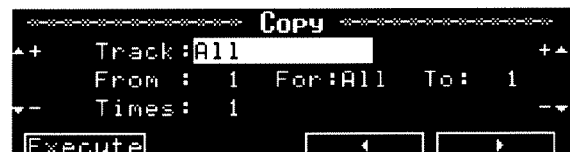

### 2. Use <◀> and <▶> at the bottom of the display to choose the item, then use <+> and <-> next to the display to select the value.

## 3-1 Composer Menu

### Track : Track number

Selecting "All" chooses all tracks.

### From : The starting measure

### For : The number of bars from the starting measure

Selecting "All" chooses everything from the starting measure to the end of the song.

### To : The copy destination measure

Selecting "End" chooses the end of the song.

### Times : The number of times to copy

3. When you've finished making the settings, press <Execute>.

## Deleting a Measure—Delete

This deletes a portion of a performance.

When a portion of a performance is deleted, any following portion of the performance is shifted forward.

\* Once a measure has been deleted, it cannot be restored.

### 1. Press <Delete>.

A screen like the one below appears on the display.



2. Use <◀> and <▶> at the bottom of the display to choose the item, then use <+> and <-> next to the display to select the value.

### Track : Track number

Selecting "All" chooses all tracks.

### From : The starting measure

### For : The number of bars from the starting measure

Selecting "All" chooses everything from the starting measure to the end of the song.

3. When you've finished making the settings, press <Execute>.

## Inserting a Blank Measure—Insert

Insert is a function that inserts a blank measure at a specified position in a performance.

### 1. Press <Insert>.

A screen like the one below appears on the display.

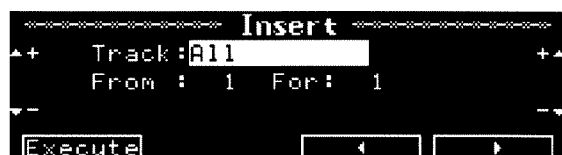

2. Use <◀> and <▶> at the bottom of the display to choose the item, then use <+> and <-> next to the display to select the value.

### Track : Track number

Selecting "All" chooses all tracks.

### From : The starting measure

Selecting "End" chooses the end of the song.

### For : The number of bars from the starting measure

Selecting "All" chooses everything from the starting measure to the end of the song.

3. When you've finished making the settings, press <Execute>.

## Changing the Key—Transpose

You can change the key of each track in semitone steps.

### 1. Press <Transpose>.

A screen like the one below appears on the display.

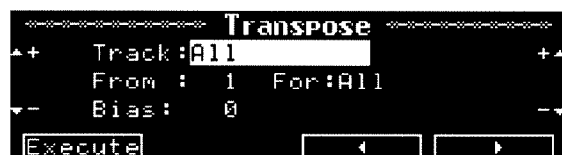

2. Use <◀> and <▶> at the bottom of the display to choose the item, then use <+> and <-> next to the display to select the value.

### Track : Track number

Selecting "All" chooses all tracks.

### From : The starting measure

### For : The number of bars from the starting measure

Selecting "All" chooses everything from the starting measure to the end of the song.

### Bias : Amount of transposition

A value within the range of -24 to +24 (in semitone steps) can be specified.

3. When you've finished making the settings, press <Execute>.



## Swapping and Copying Tracks —Track Exchange/Track Copy

This can swap track numbers or copy the contents of one track to another track.

1. Press <Trk Exchng/Copy>.

A screen like the one below appears on the display.



2. Use <◀> and <▶> at the bottom of the display to choose the item, then use <+> and <-> next to the display to select the value.

**Mode** : Track Exchange Swaps tracks  
: Track Copy Copies a track

3. When you've finished making the settings, press <Execute>.

\* When copying a track, any performance existing at the copy destination is overwritten by what is copied.

# 3-2 Function Menu

With the Basic, Piano, and Organ screens, there are various convenient functions you can use for working with performances.

## Operating Procedure for the Function Menu

1. Press <Func...>. The Function menu will appear on the screen.
2. Select a function with the buttons below the display.
3. Set the function with the buttons to the side of the display.

### <Piano Screen Functions>

## Changing the Metronome Volume and Beat

1. Press <Metronome>. "Volume" and "Beat" will appear in the display. Ten volume levels will be displayed.

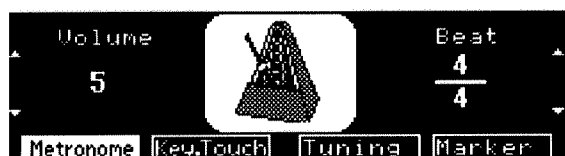

2. Using the buttons next to the display, adjust the volume and beat.

- \* The volume is set to "5" when the power is turned on.
- \* Beat is set by pressing the Style Group button, then changing the beat for those Styles.
- \* You cannot change the beat while in Style mode or when you are using the Composer function.

## Changing the Touch of the Keys

You can adjust the touch of the keyboard, with five levels to choose from.

1. Press <Key Touch>, and the touch level will appear in the right of the screen. Refer to this setting when making settings as you play the keyboard.



- \* The force you used to finger the keyboard is displayed on the left-hand side of the screen. You can refer to this when setting the touch as you play the keyboard.

2. Move "▼" with the button to the right of the screen.

Each time you move the arrow, the touch level changes. The keyboard touch and the "▼" symbol correspond in the following way:

### "▼" Symbol Position

LIGHT

HEAVY

Medium

### Keyboard Touch

Gives the keyboard a light feel. This setting makes performances easy to play, even for children who aren't so strong.

Gives the keyboard a heavy feel. Allows more emotional expression during dynamic play. This setting is useful for those who play with a strong touch, or those who want to do disciplined training.

A normal setting. This setting gives the touch closest to that of an acoustic piano.

- \* You can also change the keyboard touch with the Utility menu (p.65).

## Changing the Keyboard's Tuning —Tuning

You can select the tuning of the keyboard.

### ● Stretch Tuning

“Stretch Tuning” is a method of tuning unique to pianos. Compared with equal tuning, pitches in a piano’s lower range are adjusted lower, and in the upper range the pitch is adjusted higher. When the power is turned on, the piano tuning is set to “ON.”

### ● Temperament

“Temperament” is another method of tuning. With it you can perform Baroque and Classical pieces with the tuning of those periods.

1. When you press <Tuning>, a screen like the one shown below will appear in the display.

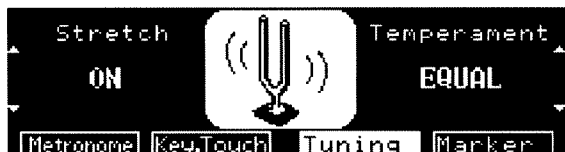

### Stretch Tuning

2. Set the Stretch Tuning ON/OFF with the buttons to the left of the display.

The following shows the relationship of the Stretch Tuning ON/OFF and the type of tuning:

**ON** : Like an acoustic piano, the lower range is tuned a little low, and the upper range a little high.

**OFF** : All pitches are tuned equal.

### Temperament

2. Set the tuning method with the buttons to the right of the display.

You can choose from the following seven types of tuning.

#### EQUAL

The most common kind of tuning today. In this tuning, an octave is divided into twelve equal parts.

#### PYTHAGOREAN

Uses the Pythagorean scale. Devised by Pythagoras, the fourth and fifth are kept from becoming ambiguous in this tuning.

#### JUST (MAJOR)

In this tuning, the third and fifth are kept from becoming too ambiguous.

#### JUST (MINOR)

With this tuning you can achieve the same effect in a minor key that you do in a major key.

#### MEAN TONE

A partial compromise of the Just (Major) tuning, to make transposition possible.

#### WERCKMEISTER

A combination of mean tone and Pythagorean tunings.

#### KIRNBERGER

An improvement of the mean tone and Just (Major) tunings, it is a tuning which allows greater freedom of transposition.

When performing with these alternative tunings, you need to specify the fundamental tones (the root for a major tuning, the sixth for minor) to match the key of the song you are performing.

When you are performing ensemble with another instrument, please tune to the fundamental tones of that instrument.

3. Set the Keynote by pressing the Key while holding down <Tuning>, when you wish to choose any other temperament than EQUAL.

\* When you make tuning changes, it affects the tuning of all of the sounds, including those on disk.

## Repeatedly Playing Back the Same Section—The Marker Function

When playing back music data or performances you have recorded, you can mark places you want to play back over and over. At the touch of a button, you can go to a marked point, or even have a section repeat automatically.

Marks are placed at the beginning of measures.

This feature is very convenient when, while playing Minus-One Play, you want to practice difficult passages by repeating them over and over. This function is called the “Marker” function.

1. Press <Marker>.

The “Marker Screen, like the one shown below, will appear in the display.

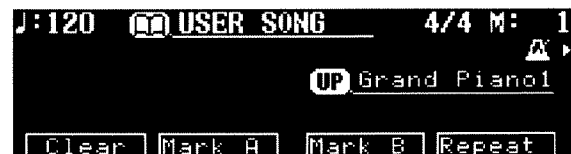

### Playing Back From a Marked Location

You can place marks at two locations in a song. When you put a marker in a song, playback will start from the beginning of the measure where the marker is put.

Ex. : Going to the fifth measure and starting playback.

## 3-2 Function Menu

2. Go to the target measure by pressing the [Fwd] and [Bwd] buttons.

The measure number appears in the upper right of the screen.

3. Press <Mark A> at the fifth measure.

<Mark A> changes to show "A:5."

4. Press the [Play] button.

Playback of the performance will begin at measure five.

5. Press <A:5>.

The performance will return to the beginning of the fifth measure, and begin playing back again.

\* While you can use <Mark A> and <Mark B> in the same song, you cannot put a marker at an earlier point than where <Mark A> is located.

\* With good timing you can press <Mark A>, <Mark B> during playback of a song. In such a case, the marker will be placed at the downbeat of the measure closest to where the button was pressed.

### Repeated Playback

Ex.: Repeating Playback of Measures 5- 8

2. Go to the target measure by pressing the [Fwd] and [Bwd] buttons.

The current measure number appears in the upper right of the screen.

3. Press <Mark A> at measure five.

The display changes to show "A:5."

4. Press <Mark B> at measure nine. The display changes to show "A:9."

Now, Mark A has been placed at measure five, Mark B at measure nine.

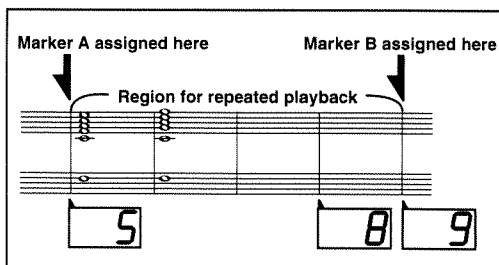

5. Press <Repeat>.

The song will return to measure five, where Mark A is located.

6. Press the [Play] button.

Measures five through eight will play back repeatedly.

\* If a song only has a Mark A, then if you press <Repeat>, the song will repeat between Mark A and the end of the song.

Likewise, if a song only has a Mark B, then if you press [Repeat], the song will repeat between the beginning of the song and Mark B.

### Erasing Marks

While holding down <Clear>, press either <A:(the measure number)> or <B:(the measure number)>.

### <Organ Screen Functions>

- For information on Marker operations, take a look at p.59.

## Using the Arranger Function

In the Organ screen, even if you press the [Start/Stop] or [Intro/Ending] buttons, only the Style's rhythm will sound, but while using the One Touch Arranger function, you can still perform Styles.

1. Press <Arranger>, and a screen like the one shown below will appear in the display.



2. Using the button to the side of the display, you can turn the Arranger function on and off.

Arranger is set to "OFF" when the power is turned on.

## Turning the Lower Tone On and Off/Changing the Split Point

You can switch the Lower Tone on and off.

You can change the Split Point anywhere from B1 to B6.

1. Press <Split>, and a screen like the one shown below will appear in the display.



### Turning the Lower Tone On and Off

2. Switch the Lower Tone on and off using the button to the left of the display.

## Changing the Split Point

- Using the button to the right of the display, select the Split Point.

Each time you press the button, the Split Point will shift one key.

\* After carrying out procedure 1, you can change the Split Point even just by pressing the key where you want the keyboard to be split while holding down <Split>.

### <Basic Screen Functions>

- The information on Split operations, take a look at p.60
- The information on Marker operations, take a look at p.59

## Changing Arranger Settings

When the power is switched on, choosing a Style may cause the tempo and Upper tones to be selected automatically, or may automatically switch on Chord Intelligence. You can use the procedure described below to change these settings.

- Press <Auto>. A screen like the one shown below will appear in the display.



### Changing the type of automatic settings

- Select what you are going to change with the button to the left of the display.

#### Full Auto :

When the Style is changed, the Upper tone, the tempo and other functions are automatically changed to best suit the new Style.

#### Tone Lock :

Even if the Style is changed, the tone is not.

#### Tempo Lock :

Even if the Style is changed, the tempo is not.

#### Tone, Tempo Lock :

Even if the Style is changed, the Tone and the Tempo are not.

#### OFF :

Even if the Style is changed, the Tone, Tempo and other functions are not.

\* "Full Auto" is set to be switched on by default.

## Chord Intelligence ON/OFF

- Set the Chord Intelligence ON/OFF with the buttons to the right of the display.

\* Chord Intelligence is set to be switched on by default. For more detailed information about Chord Intelligence, please refer to p.38.

## Changing Chord Tone and Bass Tone

When you stop performance of a Style, the Lower keyboard will sound if played. This is called "Chord Tone." When Chord Tone is playing, the chord root, or Bass Tone also sounds.

Ordinarily these tones are predetermined, but they can be changed through the following procedure.

- Press <Chord>.

A screen like the one shown below will appear in the display.

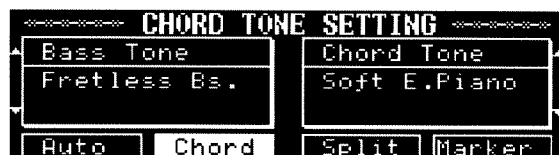

- Select the Bass Tone using the buttons to the left of the display, and the Chord Tone with the buttons to the right of the display.

When you don't want the Bass Tone or Chord Tone to sound, Select "OFF."

\* Some tones can be used with hold function. When such tones are played, the last notes will be held until the next notes are played.

\* When the power is turned on, <Chord Tone> is set to "Soft E.Piano" and <Bass Tone> is set to "Fretless Bs."

# Registering Panel Settings and/or Performance Function

## Registering Panel Settings —User Program

You can register the panel settings to the [User Program] button. Registered panel settings are called a "User Program." A User Program can be called up easily, which makes it handy for registering often-used panel settings.

1. Make the panel settings that you want to register.

2. Press the [User Program] button.

A "User Program screen" like the one below appears on the display.



3. While holding down <Write>, use the buttons to the side of the display to choose a User Program Number.

After a few seconds, the display returns to the original screen.

\* You cannot register settings to <Manual>.

\* When the power is switched on, a few User Programs are registered as examples.

\* You can change the name of a User Program. Check out "Changing the Name of a User Program" (p.62).

\* Do not turn the unit off until the operation is completed.

## Calling Up Panel Settings from the [User Program] Button

1. Press the [User Program] Button

The User Program screen (top figure) is displayed.

2. Use the buttons to the side of the display to choose a User Program Number.

\* Choosing <Manual> changes the panel settings to the ones in effect before the User Program was called up.

\* You can change the speed of the timing at which settings for a Style performance are called up. Check out "Arranger Update for User Programs" (p.68).

## Changing the Name of a User Program

You can change the name given to a User Program.

1. At the User Program screen, hold down the [User Program] button and choose the User Program Number.

A screen like the one below appears on the display.



2. Use <◀> and <▶> at the bottom of the display and <▲> and <▼> on the left of the display to assign a name.

A list of the characters you can use is shown on p.47.

3. Press <Execute>.

\* Do not turn the unit off until the display returns to the User Program screen.

## Saving User Programs to Disk

You can register up to 32 User Programs, including Manual settings, on the KR-770. These 32 User Programs make up one set, and up to 99 sets can be saved on a disk.

\* User Programs can only be saved on a disk that has been formatted by the KR-770. If you're using an unused disk, first format it (p.51), then carry out the following steps.

1. Make sure the write-protect tab on the disk to be used is set to "Write" (see p.8), then insert the disk in the disk drive.

2. Press the [User Program] button.

The User Program screen is displayed.

3. Press <Disk...>.

A screen like the one below appears on the display.



4. Use <▲> and <▼> on the right of the display to assign a number.

You can select any number from 1 to 99. Numbers already in use on the disk appear in reverse video. If you choose a number in reverse video, it is overwritten.

5. Use <◀> and <▶> at the bottom of the display and <▲> and <▼> on the left of the display to assign a name.

A list of the characters you can use is shown on p.47.

6. Press <Save> at the bottom right of the display.

\* To stop the operation, press the [Exit] button.

\* Do not turn the unit off while "Saving..." still appears in the display.

## Calling Up a User Program on Disk

1. Insert the floppy disk on which the User Program is saved into the disk drive.
2. Press the [User Program] button.  
The User Program screen is displayed.
3. Press <Disk...>.
4. Use <▲> and <▼> on the right of the display to choose the User Program.
5. Press <Load> at the bottom right of the display.  
\* To stop the operation, press <Cancel>.
6. Press <OK>.

## Registering Program Functions - The Pad Buttons

You can assign a wide variety of performance-related functions to the two Pad buttons on the panel. After the functions have been registered, they can be called up simply by pressing the buttons.

1. At the Basic screen, press <Pad/Pedal>.  
A screen like the one below appears on the display.



2. Use <▲> and <▼> to the side of the display to choose the functions for "Pad 1" and "Pad 2."  
The following chart explains the on-screen displays and the functions.

1. **Leading Bass**  
This switches the Leading Bass function on or off. During normal Style Play, the root of the chord played is used as the bass note, but when the Leading Bass function is used, the lowest note of the chord actually played is used as the bass note. This means that the bass note changes when an inverted chord is used.  
\* If you register the function to the pedal, the Leading Bass function is in effect for as long as the pedal is depressed.
2. **Break**  
During Style Play, you can stop the accompaniment for one measure by pressing the pad button.
3. **Fill In To Var.**  
This has the same effect as the Fill In [To Variation] button (see p.37).
4. **Fill In To Org.**  
This has the same effect as the Fill In [To Original] button (see p.37).
5. **Fill In**  
This inserts a Fill-in, but the accompaniment pattern thereafter does not change.
6. **Original/Variation**  
This changes to Original or Variation without inserting a Fill-in.
7. **Basic/Advanced**  
This has the same effect as pressing <Advnc < Basic> or <Advnc > Basic>.
8. **Simple Intro/Ending**  
A simple Intro or Ending is selected when this button is pressed.
9. **Melody Intelligence**  
This has the same effect as the [Melody Intelligence] button (see p.40).
10. **Arranger Intro/Ending**  
This has the same effect as the [Intro/Ending] button.
11. **Arranger Start/Stop**  
This has the same effect as the [Start/Stop] button.
12. **Fade In/Out**  
Pressing this button, you can fade in (whereby the volume gradually increases) to the start of a Style, or fade out (whereby the volume gradually decreases) to the end of a Style.

## Registering Panel Settings and/or Performance Function

### 13. Chorus On/Off

This toggles the Chorus effect for Whole or Upper Tones on or off.

### 14. Rotary Speed Fast/Slow

This changes the speed of the Rotary effect.

### 15. DSP ON/OFF

This toggles the DSP effect on or off.

### 16. Glide

When this button is pressed, the pitch drops momentarily, then gradually rises to its original level. This is effective when used to play a Hawaiian guitar and the like.

### 17. Composer Play/Stop

This has the same effect as the [Play] or [Stop] buttons.

### 18. Metronome ON/OFF

This toggles the Metronome on or off.

### 19. Punch In/Out

Recording is started when this button is pressed. For details, check out "Changing the Recording Method—Recording Mode" (p.51).

\* To stop an operation, press the [Exit] button.

### 24. Bend Down

This drops the pitch of the Upper, Layer Part. (\* You can change the range of the pitch. See "Setting the Bend Range" on p.67.)

After a few seconds, the display returns to the previous screen.

\* When the One Touch Program [Piano] button is pressed, "Left" becomes "Soft" and "Center" becomes "Sostenuto."

## Changing How the Pedals Work

You can change the functions of the left and center pedals.

1. At the Basic screen, press <Pad/Pdl>.

2. Press <Page ►►>.

3. Use <▲> and <▼> to the side of the display to switch the functions of the left pedal (Left) and the center pedal (Center).

The following chart and the chart under "Registering Program Functions—The Pad Buttons" (p.63) explain the on-screen displays and the functions.

### 20. Soft for Upper

The pedal becomes the Soft pedal (affecting the Upper Part or the Whole Part).

### 21. Sostenuto for Upper

The pedal becomes the Sostenuto pedal (affecting the Upper Part or the Whole Part).

### 22. Damper for Lower

The pedal becomes the Damper pedal (affecting only the Lower Part).

### 23. Bend Up

This raises the pitch of the Upper, Layer Part. (\* You can change the range of the pitch. See "Setting the Bend Range" on p.67.)



# 3-4 Utility Menu

The Utility Menu offers a wide variety of functions for performances other than the ones we've seen so far.

## Operating Procedure for the Utility Menu

### 1. Press the [Utility] button.

The Utility Menu screen appears, giving access to the Utility Menu.

### 2. Use <Page ►►> or <◄◄ Page> to change pages and choose the function you want.

The Utility Menu is made up of 14 pages.

Screen page	Function (Page in the Owner's Manual)
1	Master Tuning (p.65)
2	Key Touch/Transpose (p.65)
3	Metronome Volume and Beat (p.66)
4	Reverb/Chorus Effect Type (p.66)
5	Expanded Tone Selection (p.67)
6	LCD Contrast (p.67)
7	Lyric Display On/Off (p.67)
8	Bend Range (p.67)
9	Send Program Change (p.67)
10	MIDI Send Channel/Local Control (p.68)
11	Arranger Update For User Program (p.68)
12	Memory Backup (p.69)
13	Factory Preset (p.69)
14	Linking the Keyboard and 16 Track Sequencer (p.69)

### 3. Use the buttons to the side and at the bottom of the display to make the settings for each of the functions.

To return to the settings in effect when the power was first turned on, press <▲> and <▼> to the side of the display at the same time.

When settings have been made, the display automatically returns to the original screen after a few seconds. You can also return the display to the original screen by pressing the [Exit] button.

*\* If you want to cancel the operation, press the [Exit] button before changing any settings.*

The display returns to the original screen.

## Adjusting the Pitch—Master Tuning

If you're playing along with another instrument, you'll have to adjust the pitch of the note that is used for reference. Ordinarily, the middle A key is used as the standard, and the pitch of middle A in Hertz ("Hz") is adjusted to match the other instrument. The pitch of this note is called the "standard pitch." When the power is switched on, the KR-770's standard pitch is set to 440 Hz.

This adjustment of the standard pitch is called "Master Tuning."

### 1. At the Utility Menu screen, press <Page ►►> and <◄◄ Page> to display a screen like the following.



### 2. Use the buttons on the side of the display to set the standard pitch.

The standard pitch can be adjusted within a range of 415.3 to 466.2 Hz.

*\* This tuning affects all sounds, including performances played back from a disk.*

## Changing the Keyboard Touch/ Changing the Key—Transpose

### 1. At the Utility Menu screen, press <Page ►►> or <◄◄ Page> to display a screen like the following.



### Keyboard Touch

You can vary the touch of the keyboard along a range of five steps.

### 2. Use the buttons on the left of the display to change the key touch.

The keyboard touch corresponds to on-screen displays as follows :

Display	Keyboard touch
Super Light	will play fortissimo with the slightest touch.
Light	will play fortissimo with a touch weaker than ordinary, so the keyboard feels lighter than usual. With this setting, even weaker children will find it easy to play.
Medium	Normal setting, with a touch closest to that of an acoustic piano.
Heavy	fortissimo can't be produced without playing with a stronger touch than usual, so the keyboard feels heavier.
Super Heavy	You can play fortissimo only with the strongest touch. You can add more feeling when playing dynamically. A useful setting for those who normally play with a strong touch, or for those who want to strengthen their fingers.

## 3-4 Utility Menu

\* You can also change the keyboard touch with the functions under the Piano menu (p.58).

### Transpose

You can change the key of what you play without changing the position of your fingers on the keyboard.

For instance, when performing Minus-One Play (p.44) using SMF data in a difficult key with many sharps and flats, you can leave the backing performance in the original key and transpose only the part you play to a key that is easier to finger.

### 2. Use the buttons on the right of the display to select the amount of transposition.

The current setting (-6 to 0 to 5) appears on the display. The key changes in semitone steps.

Ex : When you select "2" for the value of Transpose.

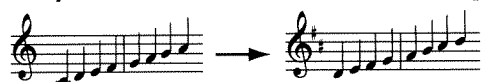

This is played,...      ...this is what you hear.

\* Accompaniment during Style Play also changes in the same way as the Upper part.

## Changing the Volume and Beat of the Metronome

### 1. At the Utility Menu screen, press <Page ►►> and <◀◀ Page> to display a screen like the following.

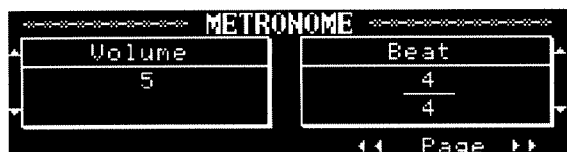

### 2. Press the buttons to the side of the display to adjust the volume and beat.

For volume, a larger value produces a louder sound.

\* When the Style Group button is pressed, the beat that has been set changes to the beat for that Style.

\* The beat cannot be changed during Style Play or when using the Composer.

## Changing the Type of Reverb or Chorus Effect

You can choose the type of Reverb or Chorus effect.

### 1. At the Utility Menu screen, press <Page ►►> and <◀◀ Page> to display a screen like the following.



### 2. Use the buttons on the left of the display to choose the Reverb type, and use the buttons on the right to choose the Chorus type.

#### Reverb Types

Room 1	Reverberations of a conference room
Room 2	Reverberations of a small live-stage house
Room 3	Reverberations with a feeling of spaciousness
Hall 1	Reverberations of a large concert hall
Hall 2	Reverberations of a small concert hall
Plate	Bright, metallic reverberations
Delay	A sound that is repeated like an echo
Pannig Delay	A delay sound that moves back and forth between the left and right speakers

#### Chorus Types

Chorus 1	A shallow chorus with slow undulations
Chorus 2	A shallow chorus with rapid undulations
Chorus 3	A deep chorus with slow undulations
Chorus 4	A deep chorus with rapid undulations
Feedback Cho.	A soft sound with an effect like a flanger
Flanger	Resonation like a jet taking off and landing
Short Delay	A delay with a short delay time
Short Dly (FB)	A short delay with many repetitions

\* The type selected is applied to all Tones.

## Choosing an Expansion Tone

In addition to the KR-770's built-in Tones, you can also play 300 types of Expansion Tones.

For more details about Expansion Tones, take a look at the "Expansion Tone List" (p.76).

\* Expansion Tones can be used in the following Parts.

Whole Keyboard Play

Upper Part for Style Play or Split Play

1. At the Utility Menu screen, press <Page ►►> and <◄◄ Page> to display a screen like the following.



2. Use the buttons on the side of the display to choose a Tone.

\* An Expansion Tone is only temporarily selected. If you change the performance mode (for example, if you change from Whole Keyboard Play to Split Play), the sound returns to the previously selected ordinary Tone.

\* A performance that uses Expansion Tones can be recorded with the Composer, but cannot be registered to a User Program.

## Adjusting the Contrast of the Display

You can adjust the contrast of the display within a ten-step range.

1. At the Utility Menu screen, press <Page ►►> and <◄◄ Page> to display a screen like the following.



2. Use the buttons on the side of the display to adjust the contrast.

## Switching Off the Display of Lyrics

When using the KR-770 to play music data containing lyrics the lyrics are automatically shown on the display. You can switch off this display of the lyrics.

1. At the Utility Menu screen, press <Page ►►> and <◄◄ Page> to display a screen like the following.

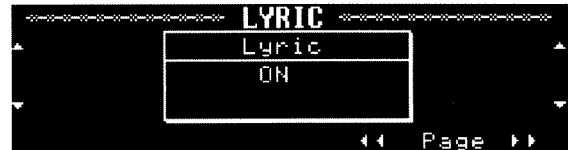

2. Use the buttons on the side of the display to set this on or off.

\* Lyrics on the display will disappear by pressing one of any panel buttons.

They will be displayed again by pressing the [Play] button.

## Setting the Bend Range

This sets the maximum amount of change (range) that control how much the pitch changes when using the Bender function.

1. At the Utility Menu screen, press <Page ►►> and <◄◄ Page> to display a screen like the following.



2. Use the buttons on the side of the display to set the value.

The value can be set to any number from 0 to 12 (in semi-tone steps, for a maximum of one octave).

## Using MIDI to Change Tones on an External Instrument

### —Send Program Change

"Program Change" refers to information for switching Tones.

When an external MIDI device is connected, you can change the tones on the external MIDI instrument by sending a Program Change.

1. At the Utility Menu screen, press <Page ►►> and <◄◄ Page> to display a screen like the following.

## 3-4 Utility Menu



2. Use the <◀> and <▶> buttons at the lower left of the display to move the item, and use the <▲> and <▼> buttons at the side of the display to change the value.

Display	Item	Value
CC 00	Bank Select MSB	0 to 127
CC 20	Bank Select LSB	0 to 127
PC	Program Change	1 to 128

\* Each time the <▲> or <▼> button is used to change the value, the information is sent to the external MIDI device.

\* These settings cannot be sent to the KR-770's built-in sound source.

\* The Channel used to sent the information is changed to the channel set according to "Changing the MIDI Send Channel."

### Changing the MIDI Send Channel/ Setting MIDI Local Control

These settings are made when an external MIDI device is connected.

1. At the Utility Menu screen, press <Page ▶▶> and <◀◀ Page> to display a screen like the following.

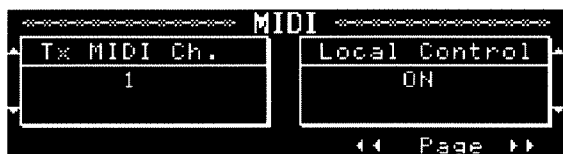

#### Changing the MIDI Send Channel

MIDI makes use of something called a "channel." By setting the KR-770 and external MIDI device to the same MIDI channel, you can use the KR-770 to do things like play sounds and switch tones on the external MIDI instrument. To do this, you need to change the MIDI send channel on the KR-770.

2. Use the buttons on the left of the display to choose the MIDI send channel.

The MIDI send channel (1 to 16) appears on the display.

\* MIDI messages sent from the external MIDI instrument are received on all channels.

\* All Keyboard information will be transmitted on one channel without regard to Split and Layer Settings.

\* Composer and Style Play cannot be sent.

#### Setting Local Control

The setting for Local Control is made when you want to exchange performance information with an external MIDI instrument. Performance information played with the keyboard is sent to the internal sound module when Local Control is on but is not sent to the internal sound module when off. (In either case, the performance information is sent out from the MIDI Out connector.)

#### ● When the External MIDI Instrument Is a Sequencer

Set Local Control to "OFF" and SOFT THRU on the sequencer to "ON." If these settings are not made, the performance on the KR-770 is sounded twice.

\* Refer to the owner's manual for your sequencer for more information on the SOFT THRU setting.

#### ● When the External MIDI Instrument Is a Synthesizer or Sound Module

No sound is produced by the KR-770 unless Local Control is on.

2. Use the buttons on the right of the display to toggle Local Control on or off.

The display shows "ON" or "OFF."

### Arranger Update for User Programs

You can set the timing that is used to call up settings for the Arranger when calling up a User Program.

1. At the Utility Menu screen, press <Page ▶▶> and <◀◀ Page> to display a screen like the following.



2. Use the buttons on the side of the display to set the timing.

**Instant:** Arranger-related settings are called up as soon as the User Program Number is pressed.

**Delayed:** Arranger-related settings are called up when the User Program Number has been depressed for several seconds.

You can call up settings for other than the Arranger by pressing and immediately releasing the User Program Number.

## Memory Backup

Some settings return to their initial values when the power is switched off. The Memory Backup function makes it possible to save such settings so that they don't revert to their initial values.

\* The following settings can be saved in memory.

- Display contrast
- Basic screen and Demo screen language
- Stretch Turing, Temperament
- Octave Shift
- Types and depth of DSP effects for each Tone
- Chorus effect on/off status for each Tone

1. At the Utility Menu screen, press <Page ►►► and <◄◄ Page> to display a screen like the following.



2. Press <Execute>.

3. Press <OK>.

\* To stop the operation, press the <Cancel>.

\* Do not turn the unit off until the display shows "Backup complete."

## Returning to the Initial Settings —Factory Preset

This returns all settings stored in the KR-770 to their initial values when shipped from the factory.

\* User Programs also return to the initial setting, so be sure to save important data first.

1. At the Utility Menu screen, press <Page ►►► and <◄◄ Page> to display a screen like the following.

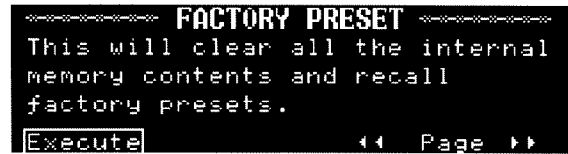

2. Preset <Execute>.

3. Press <OK>.

All settings are returned to their initial values.

\* To stop the operation, press the <Cancel>.

\* Do not turn the unit off until the display shows "Reset complete."

## Linking the Keyboard Performance Data and 16 Track Sequencer Data

This makes it possible to change the sounds of the keyboard by means of an external MIDI instrument.

1. At the Utility Menu screen, press <Page ►►► and <◄◄ Page> to display a screen like the following.



2. Use the buttons on the side of the display to toggle Link on or off.

The display shows "ON" or "OFF".

\* The linked MIDI channel becomes the channel for the track selected at the 16 Track Sequencer screen.

# 3-5. Connecting MIDI Devices and Computers

To exchange performance data between the KR-770 and external devices, this instrument features MIDI and Computer Connectors. By using these ports, you can connect external music equipment and enjoy even more creative ways of using the instrument.

## Connecting MIDI Devices

This instrument has two MIDI connectors, MIDI In and MIDI Out. By connecting these connectors with the MIDI connectors on external MIDI equipment, the instruments can control each other. For example, one machine can play sounds sent from the other, or change tones sent by the connected device.

### How Do I Connect MIDI Devices?

Set the Computer switch on the rear panel to the "MIDI" position. Using MIDI cables, connect the MIDI Connectors of this unit with those of the MIDI device.

\* When changing the position of the Computer switch, make sure that power to the KR-770 is turned OFF.

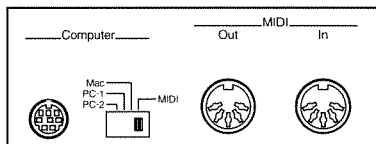

## About MIDI Connectors

Each of the MIDI Connectors works in the following way:

### ● MIDI OUT Connector

For sending performance data (such as that describing what is played on this keyboard) to connected MIDI equipment.

### ● MIDI IN Connector

For receiving MIDI information sent from external MIDI equipment. MIDI devices that receive MIDI information can do such things as play sounds, switch tones, etc.

When you use MIDI equipment to exchange performance information

Connect each of the MIDI Connectors and cables after referring to the chart below.

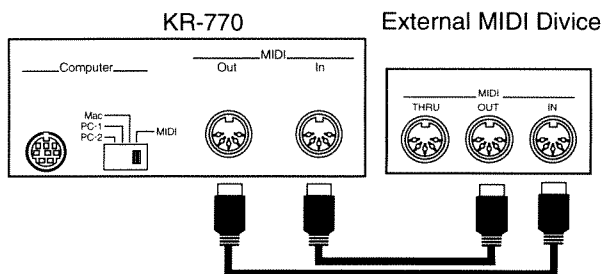

\* It is not absolutely necessary to use two MIDI cables to connect the equipment. Make your MIDI cable connections according to how you will use the equipment.

\* A publication containing a very detailed description of how to send and receive data using MIDI, the "MIDI Implementation," is sold separately. If you want to connect other MIDI devices for high-level uses, or need detailed information, please order or purchase this from your dealer.

## Connecting Computers

The KR-770 also features a Computer Connector. By connecting this connector with the computer's serial port, you can exchange performance information in both directions.

\* Please use a cable less than three meters in length to connect the computer to this unit. Using a cable three meters or longer may result in abnormal handling by the computer or the KR-770.

### How Do I Connect a Computer?

In order to match the baud rate (the rate at which the computer and the KR-770 send data) of this unit with your computer and software, please make the settings given in the following directions.

\* When changing the position of the Computer switch, make sure that power to the KR-770 is turned OFF.

### ● When Connecting Apple Macintosh Series Computers

Connect the modem port (or printer port) of Apple Macintosh computers to this instrument's Computer Connector using the RSC-15APL computer cable (sold separately). Set the Computer switch on the rear panel to "Mac."

Also, if you are using "Patch Bay" on the Macintosh, set the Interface Type (MIDI Interface Clock) to 1 MHz.

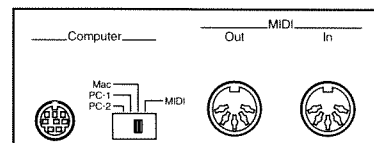

### ● Connecting IBM PC Computers

Connect the COM 1 or COM 2 ports on IBM PC computers to this unit's Computer Connector with the RSC-15AT computer cable (sold separately). Set the Computer switch on the rear panel to "PC-2."

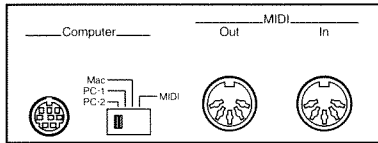

\* For more on baud rates and related subjects, please consult your software owner's manual.

For settings other than these, make settings to the MIDI send channels or local control on and off according to your needs.

### <Cautions>

\* Data output from the MIDI Out or computer terminals is only information about keys that are actually played.

\* When in composer, the system exclusive message from the MIDI In or computer terminal will not be called up.

\* When you want to control the keyboard tone from the computer or MIDI device, please follow the procedure below.

1. Set the KR-770's Local Control to Off.
2. Set the MIDI device or computer Soft through to On.
3. Connect the KR-770's MIDI Out to the MIDI In on the MIDI device, and the MIDI In to the MIDI device's MIDI Out. (In the case of a computer, connect only to the Computer Connector.

\* If you are going to use disks formatted with the KR-770 on other instruments or computers, prevent accidental overwriting by setting the disk's write protect tab to "Protect."

# Troubleshooting

## No Sound Is Played

- The [Volume] knob is turned down too low.
- Headphones are plugged in.
- the [Balance] knob is set to "Accomp." Move the knob to "Keyboard."
- The Part Volume button is set to "0" (see p. 41).

## No Sound Is Produced When the Keyboard Is Played

- With some performance data, the keyboard may be unresponsive after the data is played back. If this is the case, press the [Song] button and choose <U : User Song> at the upper left of the Song Select screen. Alternatively, delete the data you've recorded with the KR-770 (see p. 46).
- Local Control is set to "off." When Local Control is set to "off, no sound is produced when the keyboard is played. Set Local Control to "on."

## I Can't Choose a Tone or Style

- The Demo screen is displayed. Press the [Demo] button, then choose the Tone or Style.

## Sounds Drop Out

- The KR-770 can play a maximum of 64 notes simultaneously. The number of sounds may exceed 64 at times such as when playing while listening to a song on disk, or when you make extensive use of the Damper pedal during a performance. Sounds drop out when the total number of notes is more than 64.

## Performance Data on Disk Is Not Played Back Immediately

- SMF Music Data comes in two types: format 0 and format 1. In the case of format 1 data, some time is required before playback actually starts. Refer to the booklet that came with the SMF Music Data you're using for the format type.

## The Display Shows "PU" When Disk Performance Data Is Played Back

- When a song starts in the middle of a measure, the message "PU" (pickup) appears on the display when the song begins. After that, the measure number is displayed as usual.

## The [Fwd] Button Doesn't Fast-forward and the [Bwd] Button Doesn't Rewind

- You can't fast-forward or rewind while music data is being read in. The measure is shown in reverse video on the display while music data is being read in.

## The Tones Change

- If you change the style during Style play, the Upper tones and Tempo are also automatically changed to appropriate settings. If you wish to change only the Style without changing the Upper tones and Tempo, check out "Changing Arranger Settings" (p. 60).
- If music data contains a performance recorded to the [Whole] Track in Minus-One play, the Upper and Lower Parts may change to the same Tones as the performance.
- An Expansion Tone is only temporarily selected. If you change the performance mode (for example, if you change from Whole Keyboard play to Split play), the sound returns to the previously selected ordinary Tone.

## The Way a Tone Is Played Changes

- You can not add multiple DSP effects simultaneously, so when recording on multiple tracks while overdubbing a performance, or when playing a performance along with playback of a song, you may encounter times when you won't be able to add effects.

## I Can't Use Whole Keyboard Play

- When using the Arranger (that is, when the light for the One Touch Program [Arranger] button is lit up), Whole Keyboard play is not activated even when the Part [Whole] button is pressed. The entire keyboard is set up for chord recognition with Piano Style Arranger play (see p. 32). To activate Whole Keyboard play, press the One Touch Program [Piano] button.

## The Chord Intelligence Function Doesn't Work

- When using the Piano Style Arranger, chord recognition is activated when three or more keys are fingered at the same time.
- The Chord Intelligence function is off (see p. 60).

## The Pedals Don't Work

- The working of the left pedal and center pedal changes automatically during Style play or Split play, and can even be changed to entirely different functions. If this is the case, see "Changing How the Pedals Work" (p. 63). In addition, pressing the One Touch Program [Piano] button changes the left pedal to a Soft pedal and changes the center pedal to a Sostenuato pedal.



## I Can't Record Anything

- There is a disk in the disk drive, or performance data on disk was played back before the [Rec] button was pressed.  
If you want to record your own performance in such cases, press the [Song] button to display the Song Select screen. Choose <U : User Song> at the upper left of the display. Then press the [Rec] button. The [Play] button flashes, and you can now record.
- You're trying to redo a performance that was recorded once. To redo a recording, press the [Rec] button, then press the Track button for the track you wish to redo. The lights for the selected Track button and the [Play] button flash, and the track can now be recorded over (see p. 43).
- The recording mode is set to Punch In Recording. With Punch In Recording, recording starts when the pedal is depressed (or the Pad button is pressed), and stops when the pedal is depressed (or the Pad button is pressed) again (see p. 51).

## Certain Parts Are Not Heard When Listening to Performance Data on Disk

- The light for the Composer Track button is not lit.  
Press the Track button for the track that cannot be heard to make the button light come on.

## The Pitch Is Off

- The pitch has been shifted. Set the shift to "0" (see p. 65).
- The tuning is not correct. Revise the tuning settings (see p. 59, 65).

## I Can't Use Layer Play or Split Play

- The 16 Track Sequencer is in use. Because the performance of one type of Tone is recorded on one track, Split and Layer play cannot be recorded with the 16 Track Sequencer (see p. 49).

# Tone List

## Piano

Grand Piano1  
Grand Piano2  
UprightPiano  
Rock Piano  
Honky-tonk 1  
Honky-tonk 2  
MIDI Piano1  
MIDI Piano2

## E.Piano

E.Piano 1  
Soft E.Piano  
E.Piano 2  
Hard E.Piano  
60's E.Piano  
Clav.  
Harpsichord1  
Harpsichord2

## Vibes

Vibraphone  
Celesta  
Marimba  
Xylophone  
Glockenspiel  
Music Box  
Tubular-bell  
Santur  
Steel Drums  
Kalimba  
Barafon  
Vibra Bells

## Organ

Jazz Organ 1  
Jazz Organ 2  
Full Organ 1  
Full Organ 2  
Lower Organ1  
Lower Organ2  
Church Organ  
Organ Flute  
Theater Org.  
Trem.Flute  
Rock Organ 1  
Rock Organ 2  
Jazz Organ 3  
Jazz Organ 4

Full Organ 3  
Full Organ 4  
Pop Organ  
VS Organ  
Accordion  
Harmonica  
Jazz Organ 5  
Jazz Organ 6  
Full Organ 5  
Full Organ 6  
Jazz Organ 7  
Lower Organ3  
Full Organ 7  
Full Organ 8  
Metalic Org.  
Digi Church  
Pop Organ 1  
Pop Organ 2

## Guitar

Nylon Guitar  
Gut Guitar  
Steel Guitar  
12str Guitar  
Mandolin  
Banjo  
Hawaiian Gt.  
Muted Gt.  
JC E.Guitar  
Jazz Guitar  
Overdrive Gt  
DistortionGt  
Power Guitar  
Rock Rhythm  
Shamisen  
Koto

## Strings

Slow Strings  
Strings  
Violin  
Cello  
Choir  
Choir Oohs  
Pop Voice  
SynVox  
Harp  
Orchestra  
Syn.Strings1  
Warm Pad

## Sax

Blow Sax  
Soprano Sax  
Alto Sax  
Oboe  
Bassoon  
Clarinet  
Flute  
Blow Pipe  
Trumpet  
MutedTrumpet  
Trombone  
Fr.Horn Solo  
Brass 1  
French Horn  
Synth Brass1  
Synth Brass2

## Fantasia

Fantasia  
Brightness  
Harpvox  
Polysynth  
CC Solo  
Square Wave  
Saw Wave  
Saw  
Doctor Solo  
Syn.Calliope  
Charang  
Bass & Lead  
Pan Flute  
Shakuhachi  
Whistle  
Ocarina  
Metal Pad  
Sweep Pad  
Soundtrack  
Atmosphere  
Crystal  
Sitar  
OrchestraHit  
PizzicatoStr  
Acoustic Bs.  
A.Bass+Cymb1  
Fingered Bs.  
Picked Bass  
Fretless Bs.  
Slap Bass 1  
Organ Bass  
SynthBass101

# Style List

## Internal

### Pop

Pop 1  
Pop 2  
16BeatPop  
50's  
Pop 3  
Fusion  
16BtShuffle  
70's  
Pop 4  
Slow Dance  
Lovers  
Twist

### Piano Style

PianoBallad1  
PianoBallad2  
Stride Piano  
Nickel Odeon  
PianoBallad3  
PianoBallad4  
Club Piano  
Classical

### Ballad

Ballad 1  
16BtBallad 1  
Love Songs  
Torch Song  
Ballad 2  
16BtBallad 2  
50's Ballad

### Rock

Rock 1  
Rock 2  
UK Rock  
Rock'n'Shffl  
Rock 3  
Rock 4  
Rock 5  
Rock 6  
Rock'n'Roll1  
Rock'n'Roll2  
Rock'n'Roll3  
Rock Ballad

## Country

CountrySwing  
Twostep  
CntryBallad  
CntryWaltz 1  
Hoedown  
Bluegrass  
New Country  
ClassicCntry  
Outlaw  
Train Beat  
Country Rock  
CntryWaltz 2

## Big Band

Jazz Band  
Big Band 1  
BigBndBallad  
Boogie  
Standard  
Big Band 2

## Swing

Combo  
Medium Swing  
Shuffle  
Slow Swing  
Brush Swing

## Latin

BossaNova 1  
FastBosaNova  
Rio  
Rhumba  
BossaNova 2  
Beguine  
Mambo  
Chacha  
Salsa  
Merengue  
Tango 1  
Tango 2  
BossaNova 3  
Samba  
Calypso  
Lambada

## Waltz

Slow Waltz 1  
Waltz  
Vienna Waltz  
Musette  
Slow Waltz 2  
Pop Waltz  
Swing Waltz  
Jazz Waltz

## Kids/March

Kids 1  
Kids 2  
March 6/8  
March 4/4  
Kids 3  
Kids Waltz  
March 2/4  
Jungle

## Trad

Broadway  
Polka  
Foxtrot  
Hawaiian  
Gospel  
Dixieland  
Charleston

## World

Gt.Arpeggio1  
Kayou 1  
Techno  
House  
Gt.Arpeggio2  
Kayou 2  
Triplet Enka  
Enka  
Gt.Stroke  
Ondo  
8Beat Enka  
16Beat Enka  
NewJackSwing  
Hip-Hop  
Rap  
Easy 8Beat  
Easy 16Beat  
Easy 2Beat  
Easy Waltz

## Disk Style

Easy Listen1  
Easy Listen2  
Easy Listen3  
Easy Listen4  
Easy Listen5  
Easy Listen6  
Dance1  
Dance2  
Dance3  
Dance4  
Dance5  
Dance6  
Funk1  
Funk2  
Funk3  
JazzFunk  
Rhythm&Blues  
Blues1  
Blues2  
Five  
Afro & Swing  
Ragtime  
Rhumba1  
Rhumba2  
Showtime1  
Showtime2  
SlowFoxtrot  
FrenchWaltz  
Gospel1  
Gospel2  
Gospel3  
Baroque

# Expansion Tone List

No.	Tone Name	CC 0	CC 32	PC#	No.	Tone Name	CC 0	CC 32	PC#	No.	Tone Name	CC 0	CC 32	PC#
*001	Grand Piano1	08	64	001	*053	Jazz Organ 7	32	66	018	105	Mellow Gt.	01	02	027
*002	Grand Piano2	08	64	002	*054	Full Organ 1	00	65	017	*106	Hawaiian Gt.	08	64	027
*003	UprightPiano	16	64	001	*055	Full Organ 2	08	65	017	107	GS Hawaiian	08	00	027
*004	MIDI Piano1	00	65	001	*056	Full Organ 3	16	65	017	*108	JC E.Guitar	00	64	028
*005	MIDI Piano2	00	65	002	*057	Full Organ 4	32	65	017	109	Clean Gt.	00	00	028
006	Piano 1	00	00	001	*058	Full Organ 5	00	67	017	110	Chorus Gt.	08	00	028
007	Piano 1d	16	00	001	*059	Full Organ 6	08	67	017	*111	Muted Gt.	00	00	029
008	Piano 2	00	00	002	*060	Full Organ 7	16	67	017	112	Muted Dis.Gt	00	64	029
009	Piano 3	00	00	003	*061	Full Organ 8	32	67	017	113	Funk Gt.	08	00	029
010	EG+Rhodes 1	00	65	003	*062	Lower Organ1	00	66	017	114	Funk Gt.2	16	00	029
011	EG+Rhodes 2	00	66	003	*063	Lower Organ2	08	66	017	*115	Overdrive Gt	00	00	030
*012	Rock Piano	08	64	003	*064	Lower Organ3	16	66	017	*116	DistortionGt	00	64	031
*013	Honky-tonk 1	08	64	004	065	Organ 1	00	00	017	117	GS Dist.Gt.	00	00	031
*014	Honky-tonk 2	08	00	004	066	Organ 2	00	00	018	118	Dazed Guitar	00	65	031
*015	E.Piano 1	16	64	005	*067	Pop Organ	18	00	017	*119	Rock Rhythm	08	66	031
*016	E.Piano 2	16	64	006	*068	Pop Organ 1	16	00	017	120	Rock Rhythm2	00	66	031
017	E.Piano 3	00	65	006	*069	Pop Organ 2	08	64	017	121	Feedback Gt.	08	00	031
018	Hard Rhodes	00	65	005	*070	VS Organ	32	64	017	122	Feedback Gt2	09	02	031
019	Detuned EP 1	08	00	005	*071	Metalic Org.	32	66	017	*123	Power Guitar	08	65	031
020	Detuned EP 2	08	00	006	072	Detuned Or.1	08	00	017	124	Power Gt.2	08	64	031
*021	Soft E.Piano	08	64	005	073	Detuned Or.2	08	00	018	125	5th Dist.	18	02	031
022	FM+SA EP	16	02	005	*074	Rock Organ 1	00	64	019	126	Gt.Harmonics	00	00	032
*023	60's E.Piano	24	00	005	*075	Rock Organ 2	00	00	019	*127	Acoustic Bs.	00	64	033
*024	Hard E.Piano	00	64	006	076	Rotary Org.S	00	65	019	*128	A.Bass+Cymb1	00	65	033
025	St.FM EP	08	64	006	077	Rotary Org.F	00	66	019	129	GS Ac.Bass	00	00	033
026	Hard FM EP	08	66	006	*078	Organ Flute	00	64	020	*130	Fingered Bs.	00	64	034
027	E.Piano 1	00	00	005	*079	Church Organ	08	65	020	131	GS Fing.Bass	00	00	034
028	E.Piano 1v	16	00	005	*080	Digi Church	00	64	021	*132	Picked Bass	00	64	035
029	GS E.Piano2	00	00	006	*081	Theater Org.	16	64	020	133	GS Picked Bs	00	00	035
030	E.Piano 2v	16	00	006	*082	Trem.Flute	08	64	020	134	Mute PickBs.	00	65	035
*031	Harpsichord1	00	64	007	083	Pipe Org. Bs	32	65	018	*135	Fretless Bs.	00	00	036
*032	Harpsichord2	08	64	007	*084	Organ Bass	40	02	017	136	Mr.Smooth	05	02	036
033	Harpsichord	00	00	007	085	Reed Organ	00	00	021	*137	Slap Bass 1	00	00	037
034	Coupled Hps.	08	00	007	*086	Accordion	00	64	022	138	Slap Bass 2	00	00	038
035	Harpsi.o	24	00	007	087	Accordion Fr	00	00	022	139	Synth Bass 1	00	00	039
*036	Clav.	00	00	008	088	Accordion It	08	00	022	140	Synth Bass 2	00	00	040
037	Analog Clav.	00	64	008	*089	Harmonica	00	64	023	141	Synth Bass 3	08	00	039
*038	Celesta	00	00	009	090	GS Harmonica	00	00	023	142	Synth Bass 4	08	00	040
*039	Glockenspiel	00	00	010	091	Bandoneon	00	00	024	*143	SynthBass101	01	00	039
*040	Music Box	00	00	011	*092	Nylon Guitar	00	64	025	144	Reso SH Bass	16	02	039
*041	Vibraphone	00	64	012	*093	Gut Guitar	00	65	025	145	SH101 Bass	16	64	040
*042	Marimba	08	00	013	094	GS Nylon Gt.	00	00	025	146	Smooth Bass	19	02	040
*043	Barafon	08	64	013	095	Ukulele	08	00	025	147	Acid Bass	08	02	039
*044	Xylophone	00	00	014	096	Nylon Gt.o	16	00	025	*148	Violin	00	64	041
*045	Tubular-bell	00	00	015	*097	Steel Guitar	00	64	026	149	GS Violin	00	00	041
*046	Santur	00	64	016	098	Steel-str.Gt	00	00	026	150	Slow Violin	08	00	041
*047	Jazz Organ 1	32	00	018	*099	12str Guitar	08	64	026	151	Viola	00	00	042
*048	Jazz Organ 2	32	64	018	100	12-str.Gt	08	00	026	*152	Cello	00	64	043
*049	Jazz Organ 3	08	64	018	101	Nylon+Steel	08	65	026	153	GS Cello	00	00	043
*050	Jazz Organ 4	00	65	018	*102	Mandolin	16	64	026	154	Contrabass	00	00	044
*051	Jazz Organ 5	00	66	018	103	GS Mandolin	16	00	026	155	Tremolo Str	00	00	045
*052	Jazz Organ 6	08	66	018	*104	Jazz Guitar	00	00	027	*156	PizzicatoStr	00	00	046

# Expansion Tone List

No.	Tone Name	CC 0	CC 32	PC#	No.	Tone Name	CC 0	CC 32	PC#	No.	Tone Name	CC 0	CC 32	PC#
* 157	Harp	00	64	047	* 209	Blow Pipe	00	64	076	261	Converge	00	66	096
158	GS Harp	00	00	047	210	Bottle Blow	00	00	077	262	Celestial Pd	10	02	096
159	Timpani	00	00	048	* 211	Shakuhachi	00	00	078	263	Ice Rain	00	00	097
* 160	Strings	00	64	049	* 212	Whistle	00	00	079	* 264	Soundtrack	00	00	098
161	GS Strings	00	00	049	* 213	Ocarina	00	00	080	265	Ancestral	00	64	098
* 162	Slow Strings	00	64	050	* 214	Square Wave	00	00	081	266	Prologue	00	65	098
163	GS Sl.Str	00	00	050	215	Syn.Square	00	64	081	* 267	Crystal	00	00	099
164	Warm Strings	09	02	050	* 216	CC Solo	00	65	081	* 268	Vibra Bells	00	64	099
* 165	Orchestra	08	00	049	217	Square	01	00	081	269	Clear Bells	00	65	099
166	Choir Str.	11	02	049	218	FM Lead 1	01	64	081	270	ChristmasBel	00	66	099
* 167	Syn.Strings1	00	00	051	219	FM Lead 2	00	64	088	271	Soft Crystal	02	02	099
168	Syn.Strings2	00	00	052	220	JP8 Square	08	64	081	272	Digi Bells	09	02	099
169	Syn.Strings3	08	00	051	* 221	Saw Wave	00	00	082	273	Syn Mallet	01	00	099
* 170	Choir	32	00	053	* 222	Saw	01	00	082	* 274	Atmosphere	00	00	100
* 171	Pop Voice	00	00	054	223	Mg Lead	00	64	082	* 275	Harpvox	00	64	100
* 172	SynVox	00	00	055	224	P5 Saw Lead	01	64	082	276	Nylon Harp	00	65	100
* 173	Choir Oohs	00	64	055	* 225	Doctor Solo	08	00	082	277	Nylon+Rhodes	00	66	100
* 174	OrchestraHit	00	00	056	226	Rhythmic Saw	08	64	082	* 278	Brightness	00	00	101
* 175	Trumpet	00	64	057	227	Waspy Synth	16	02	082	279	Goblin	00	00	102
176	GS Trumpet	00	00	057	* 228	Syn.Calliope	00	00	083	280	Goblinson	00	65	102
* 177	Trombone	00	64	058	229	JP8 Pulse	00	64	083	281	50's Sci-Fi	00	66	102
178	Trombone 2	01	00	058	230	Pure PanLead	02	02	083	282	Echo Drops	00	00	103
179	GS Trombone	00	00	058	231	Chiffer Lead	00	00	084	283	Echo Bell	01	00	103
180	Tuba	00	00	059	232	Cheese Saw	00	64	084	284	Big Panner	00	64	103
* 181	MutedTrumpet	00	00	060	* 233	Charang	00	00	085	285	Ai-yai-a	01	64	103
* 182	French Horn	00	00	061	234	Reso Saw	00	64	085	286	Echo Pan	02	00	103
* 183	Fr.Horn Solo	00	64	061	235	Solo Vox	00	00	086	287	Echo Pan 2	02	64	103
* 184	Brass 1	00	00	062	236	RAVE Vox	00	64	086	288	Star Theme	00	00	104
185	Brass 2	08	00	062	237	5th Saw Wave	00	00	087	* 289	Sitar 2	01	00	105
* 186	Synth Brass1	00	00	063	238	5th Lead	00	64	087	* 290	Banjo	00	00	106
* 187	Synth Brass2	00	00	064	* 239	Bass & Lead	00	00	088	* 291	Shamisen	00	64	107
188	Synth Brass3	08	00	063	240	Big & Raw	01	02	088	292	GS Shamisen	00	00	107
189	Synth Brass4	08	00	064	* 241	Fat & Perky	02	02	088	* 293	Koto	00	00	108
190	AnalogBrass1	16	00	063	* 242	Fantasia	00	00	089	* 294	Kalimba	00	00	109
191	AnalogBrass2	16	00	064	243	Fantasia 2	00	64	089	295	Bagpipe	00	00	110
192	Soft Brass	01	02	064	* 244	Warm Pad	00	00	090	296	Fiddle	00	00	111
* 193	Soprano Sax	00	64	065	245	Soft Pad	00	64	090	297	Shanai	00	00	112
194	GS Sop.Sax	00	00	065	* 246	Polysynth	00	00	091	298	Tinkle Bell	00	00	113
* 195	Alto Sax	00	00	066	247	P5 Poly	00	64	091	299	Steel Drums	00	00	115
* 196	Blow Sax	00	64	067	248	80's PolySyn	01	02	091	* 300	Falling Down	07	64	126
197	Tenor Sax	00	00	067	249	Space Voice	00	00	092					
198	Baritone Sax	00	00	068	250	Heaven II	00	64	092					
* 199	Oboe	00	64	069	251	Bowed Glass	00	00	093					
200	GS Oboe	00	00	069	* 252	Metal Pad	00	00	094					
201	English Horn	00	00	070	253	Tine Pad	00	64	094					
* 202	Bassoon	00	00	071	254	Panner Pad	00	65	094					
* 203	Clarinet	00	00	072	255	Halo Pad	00	00	095					
204	Piccolo	00	00	073	256	JP8 Sqr Pad	00	64	095					
205	GS Flute	00	00	074	* 257	Sweep Pad	00	00	096					
* 206	Flute	00	64	074	258	Sweep Pad 2	00	64	096					
207	Recorder	00	00	075	259	Polar Pad	00	65	096					
* 208	Pan Flute	00	00	076	260	Ambient Pad	06	02	100					

\*: \* indicates a Tone overlap with the Normal Tone

CC0: value of controller number 0

CC32: value of controller number 32

PC#: program number

# Error Message List

When an error message is displayed, the KR-770 returns to the state it was in before the error occurred, and only the message remains displayed. When this occurs, press the [Exit] button to delete the error message.

## E.00

Description: To prevent copyright infringement, this music data cannot be saved to a disk other than the original disk.

Instructions: Save the data to the original disk.

## E.01

Description: This type of music data cannot be saved to disk.

Instructions: This music data is designed for enjoyment as playback-only data.

## E.02

Description: The write-protect tab on the disk is set to "Protect."

Instructions: Move the tab to "Write" (p. 8).

## E.03

Description: A master disk cannot be formatted or used to save data.

Instructions: Save the data to a formatted disk on the KR-770 (p. 51).

## E.04

Description: Cannot save to this type of disk.

Instructions: Save the following three types of data to dedicated disks. Alternatively, save the data to a newly formatted disk on the KR-770.

\* Performances recorded on the KR-770

\* Performances converted to SMF data using the KR-770

\* User Styles created on the KR-770

## E.05

Description: This file cannot be overwritten.

Instructions: Choose a different number to save the data. Alternatively, save the data to a different disk formatted with the KR-770.

## E.10

Description: No disk has been inserted into the disk drive.

Instructions: Insert a disk into the disk drive.

## E.11

Description: There is not enough space on the disk to save the data.

Instructions: Use a different disk formatted with the KR-770.

## E.12

Description: Data cannot be saved because the disk is not formatted.

Instructions: Use a disk formatted with the KR-770 (p. 51).

## E.13

Description: The disk was removed while saving or formatting.

Instructions: Repeat the procedure. After starting to save data or format the disk, do not remove the disk until a message is displayed indicating that the operation has been completed.

## E.14

Description: A corrupted sector was found on the disk.

Instructions: Use a different disk formatted with the KR-770.

## E.15

Description: Data cannot be saved to this disk.

Instructions: Use a disk formatted with the KR-770 (p. 51).

## E.20

Description: This type of disk cannot be read.

Instructions: Use Roland SMF Music Data or music data that supports Roland Piano Digital. If the disk is not formatted, format it with the KR-770 (p. 51).

## E.21

Description: This type of music data cannot be read.

Instructions: Use Roland SMF Music Data or music data that supports Roland Piano Digital. In addition, only User Programs saved with the KR-770 can be used.

## E.22

Description: The disk was removed while reading.

Instructions: Insert the disk and repeat the procedure. Do not remove the disk while recording or during standby for recording. At other times as well, do not remove the disk while the light for the disk drive is lit.

### E.23

Description: A corrupted sector was found on the disk.

Instructions: This music data cannot be used.

### E.24

Description: Disk read speed is not fast enough for playback.

Instructions: Press the [Stop] button once. Press the [Reset] button, then press the [Play] button again.

### E.25

Description: This music data cannot be played.

Instructions: The music data uses performance information that is not supported by the KR-770. This music data cannot be used.

### E.30

Description: Playback is impossible because the size of the music data is too large.

Instructions: You cannot record, fast-forward, rewind, or save this music data.

### E.31

Description: Recording is impossible because the size of the music data is too large.

Instructions: You cannot record, fast-forward, rewind, or save this music data. It should be enjoyed as playback-only data.

### E.32

Description: Recording was stopped.

Instructions: The amount of performance information is too large, and further recording is not possible.

### E.34

Description: Recording and playback are impossible because the size of the music data is too large.

Instructions: This music data cannot be used.

### E.35

Description: The Style data is too large, so it cannot be read or recorded.

Instructions: Delete a recorded performance (p. 46), or save a recorded performance to disk (p. 46).

### E.36

Description: The total size of the Style data you are trying to combine is too large, and the data cannot be combined and registered. Alternatively, the size of the disk Style data you are trying to read is too large, and the data cannot be read.

Instructions: Create the User Style with another combination. Alternatively, choose a different Style.

### E.40

Description: Too much MIDI data was sent from the external MIDI instrument at one time, and the unit could not process the data.

Instructions: Reduce the amount of MIDI data being sent to the KR-770.

### E.41

Description: A problem such as a loose MIDI cable or computer cable occurred.

Instructions: Make sure the MIDI cables and computer cables are correctly hooked up.

### E.42

Description: Too much performance data was sent to the Composer at one time, and recording could not be performed.

Instructions: Make the tempo slower and record the data again.

### E.43

Description: The setting of the Computer switch on the rear panel is incorrect, or the computer settings are incorrect.

Instructions: Switch off the power and set the Computer switch correctly, then turn the power back on. Alternatively, make sure the computer settings are correct.

### E.51

Description: You could not register the setting to the internal memory.

Instructions: Try the operation again. If you cannot register the setting to the internal memory, please contact qualified service personnel.

# Intelligent Chord List

● symbol: Indicates the constituent notes of chords.

★ symbol: Chords shown with an “★” can be played by pressing just the key marked with the “★” (see “Easy Fingering for Chord–Chord Intelligence” on p. 38).

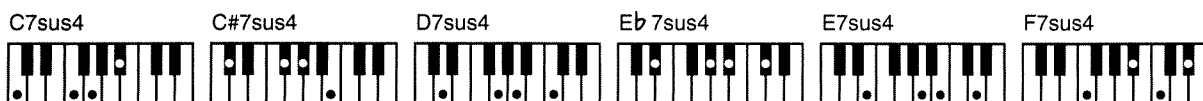
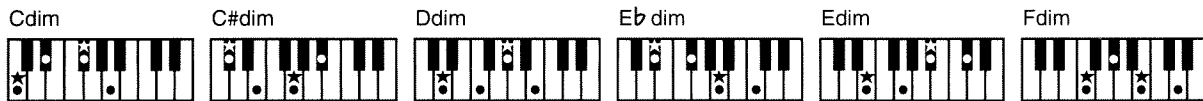



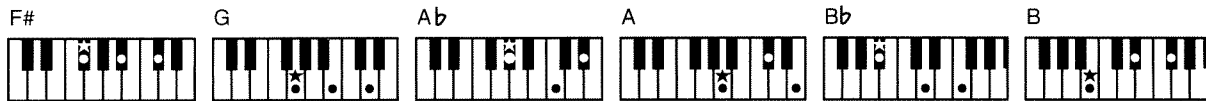

# Drum Set List

## ● Drum Set

PC#	1	9	17	25	26
CC32	64	64	0	0	0
Type	STANDARD	ROOM	POWER	ELECTRONIC	TR-808
25	Bar Chime	-----			
26	Finger Snap	-----			
27	High Q				
28	Slap				
29	Scratch Push [EXC7]				
30	Scratch Pull [EXC7]				
31	Sticks				
32	Square Click				
33	Metronome Click				
34	Metronome Bell				
35	Std Kick 2	Std Kick 1	Kick 2	Kick 2	Kick 2
C2 36	Std Kick 1	Room Kick	MONDO Kick	Elec BD	808 Bass Drum 1
37	Side Stick				808 Rim Shot
38	Std Snr 1	Room Snr 1	Gated SD	Elec SD	808 Snare Drum
39	Hand Clap				
40	Std Snr 2	Std Snr 1	Snare 2	Gated SD	Snare 2
41	Low Tom 2	Room Low Tom 2		Elec Low Tom 2	808 Low Tom 2
42	Closed Hi-hat 1 [EXC1]		Closed Hi-hat 2 [EXC1]	Closed Hi-hat 2 [EXC1]	808 CHH [EXC1]
43	Low Tom 1	Room Low Tom 1		Elec Low Tom 1	808 Low Tom 1
44	Pedal Hi-hat 1 [EXC1]		Pedal Hi-hat 2 [EXC1]	Pedal Hi-hat 2 [EXC1]	808 CHH [EXC1]
45	Mid Tom 2	Room Mid Tom 2		Elec Mid Tom 2	808 Mid Tom 2
46	Open Hi-hat 1 [EXC1]		Open Hi-hat 2 [EXC1]	Open Hi-hat 2 [EXC1]	808 OHH [EXC1]
47	Mid Tom 1	Room Mid Tom 1	Room Mid Tom 1	Elec Mid Tom 1	808 Mid Tom 1
C3 48	High Tom 2	Room Hi Tom 2	Room Hi Tom 2	Elec Hi Tom 2	808 Hi Tom 2
49	Crash Cymbal1				808 Cymbal
50	High Tom 1	Room Hi Tom 1	Room Hi Tom 1	Elec Hi Tom 1	808 Hi Tom 1
51	Ride Cymbal 1				
52	Chinese Cymbal			Reverse Cymbal	
53	Ride Bell				
54	Tambourine				
55	Splash Cymbal				
56	Cowbell				808 Cowbell
57	Crash Cymbal 2				
58	Vibra-slap				
59	Ride Cymbal 2				
C4 60	High Bongo				
61	Low Bongo				
62	Mute High Conga				808 High Conga
63	Open High Conga				808 Mid Conga
64	Low Conga				808 Low Conga
65	High Timbale				
66	Low Timbale				
67	High Agogo				
68	Low Agogo				
69	Cabasa				
70	Maracas				808 Maracas
71	Short Hi Whistle [EXC2]				
C5 72	Long Low Whistle [EXC2]				
73	Short Guiro [EXC3]				
74	Long Guiro [EXC3]				
75	Claves				808 Claves
76	High Wood Block				
77	Low Wood Block				
78	Mute Cuica [EXC4]				
79	Open Cuica [EXC4]				
80	Mute Triangle [EXC5]				
81	Open Triangle [EXC5]				
82	Shaker				
83	Jingle Bell				
C6 84	Bell Tree				
85	Castanets				
86	Mute Surdo [EXC6]				
87	Open Surdo [EXC6]				
88	-----	-----	-----	-----	-----

● Drum Set

	PC#	26	41	49
	CC32	64	64	0
	Type	DANCE	BRUSH	ORCHESTRA
	25			
26	27			Close Hi-hat [EXC1] Pedal Hi-hat [EXC1] Open Hi-hat [EXC1] Ride Cymbal
28				
29	30	Dance Snr 1		
31	32			
33	34			
35		Std Kick 1	Kick 2	Concert BD 2
C2	36	808 Bass Drum 2	Kick 1	Concert BD 1
	37	808 Rim Shot		
38	39	TR-909 Snr	Brush Tap Brush Slap Brush Swirl	Concert SD Castanets Concert SD
40		Dance Snr 2	Brush Low Tom 2	Timpani F
41	42	808 Low Tom 2	Closed Hi-hat 2 [EXC1]	Timpani F#
43	44	808 CHH [EXC1]	Brush Low Tom 1	Timpani G
45	46	808 CHH [EXC1]	Pedal Hi-hat 2 [EXC1]	Timpani G#
		808 Mid Tom 2	Brush Mid Tom 2	Timpani A
		808 OHH [EXC1]	Open Hi-hat 2 [EXC1]	Timpani A#
		808 Mid Tom 1	Brush Mid Tom 1	Timpani B
C3	48	808 Hi Tom 2	Brush Hi Tom 2	Timpani c
	49	808 Cymbal		Timpani c#
50	51	808 Hi Tom 1	Brush Hi Tom 1	Timpani d
52				Timpani d#
53	54			Timpani e
55	56	808 Cowbell		Timpani f
57	58			Concert Cymbal 2
59				Concert Cymbal 1
C4	60			
	61	808 High Conga		
62	63	808 Mid Conga		
64		808 Low Conga		
65	66			
67	68			
69	70	808 Maracas		
71				
C5	72			
	73	808 Claves		
74	75			
76	78			
77	80			
79	82			
81				
83				
C6	84			
	85	-----	-----	Applause
86	87			
88				

● SFX Set

	PC#	57
	CC32	0
	Type	SFX
	39	High Q
40		Slap
41	42	Scratch Push [EXC7]
43	44	Scratch Pull [EXC7]
45	46	Sticks
47		Square Click
		Metronome Click
		Metronome Bell
		Guitar sliding Finger
C3	48	Guitar cutting noise (down)
	49	Guitar cutting noise (up)
50	51	String slap of double bass
52		Fl.Key Click
53	54	Laughing
55	56	Screaming
57	58	Punch
59		Heart Beat
		Footsteps1
		Footsteps2
		Applause
		Door Creaking
C4	60	Door
	61	Scratch
62	63	Wind Chimes
64		Car-Engine
65	66	Car-Stop
67	68	Car-Pass
69	70	Car-Crash
71		Siren
		Train
		Jetplane
		Helicopter
		Starship
C5	72	Gun Shot
	73	Machine Gun
74	75	Lasergun
76		Explosion
		Dog
		Horse-Gallop
		Birds
		Rain
		Thunder
		Wind
		Seashore
		Stream
C6	84	Bubble
	85	Cat

PC# : Program Change Number  
 CC32 : Value of Control Change 32  
 \* Value of Control Change is set 0.

Blank : same percussion instruments as the Standard set  
 ----- : No sound  
 [EXC] : will not sound simultaneously with other percussion instruments of the same Number

# DSP Effect List

1. Overdrive: Distorts the sound a little
2. Distortion: Distorts the sound a lot
3. Phaser: Gives a swelling sound
4. Enhancer: Adds modulation to the sound
5. Auto Wah: Changes the tone in cycles
6. Compressor: Limits dynamic range by compressing higher volumes
7. Gate Reverb: A reverb that partially cuts off the lingering sounds
8. Rotary: Gives the effect of a rotating speaker
9. Hexa Chorus: Lends thickness and breadth to the sound
10. Tremolo Chorus: Gives a tremolo effect
11. Stereo Chorus: A stereo chorus
12. Stereo Flanger: Adds metallic reverberations to the sound
13. Step Flanger: A flanger with stepwise changes in pitch
14. Stereo Delay: Adds a delay to the stereo sound
15. Modulation Delay: A delay that adds undulations to the delayed sound
16. Triple Tap Delay: A three-way delay
17. Quadruple Tap Delay: A four-way delay
18. 2-Voice Pitch Shifter: Adds two pitch-shifted sounds to the original sound
19. Feedback Pitch Shifter: Adds a single pitch-shifted sound the original sound
20. Overdrive -> Chorus: The Overdrive and Chorus effects are linked together in series
21. Overdrive -> Flanger: The Overdrive and Flanger effects are linked together in series
22. Overdrive -> Delay: The Overdrive and Delay effects are linked together in series
23. Distortion -> Chorus: The Distortion and Chorus effects are linked together in series
24. Distortion -> Flanger: The Distortion and Flanger effects are linked together in series
25. Distortion -> Delay: The Distortion and Delay effects are linked together in series
26. Enhancer -> Chorus: The Enhancer and Chorus effects are linked together in series
27. Enhancer -> Flanger: The Enhancer and Flanger effects are linked together in series
28. Enhancer -> Delay: The Enhancer and Delay effects are linked together in series
29. Chorus -> Delay: The Chorus and Delay effects are linked together in series
30. Flanger -> Delay: The Flanger and Delay effects are linked together in series
31. Chorus -> Flanger: The Chorus and Flanger effects are linked together in series.
32. Sympathetic Resonance: When pressing the damper pedal, gives a resonance effect

# Profiles Of Demo Song's Composer

Song Number	Composer	
Piano 1	Scott Tibbs	©1996, Buoy Music
Piano 2	Scott Wilkie	©1996, Scott Wilkie for BeachHouse
Piano 3	Roland	©1996 Roland Corporation
Piano 4	J. S. Bach	
Organ 1	J. S. Bach	
Organ 2	Music Brains	©1996 Roland Corporation
Organ 3	Jonas Nordwall	©1996 Rodgers Instrument Corporation
Organ 4	Roland	©1996 Roland Corporation

Song Number	Composer	
Strings 1	Music Brains	©1996 Roland Corporation
Strings 2	-----	Spanish Traditional
Strings 3	W. A. Mozart	
Strings 4	F. Chopin	
Strings 5	Music Brains	©1996 Roland Corporation
Ensemble 1	Stewart Cary and Joe Millward	©1996 Roland Corporation U. S.
Ensemble 2	E. Grieg	

## Jonas Nordwall

A native of Portland, Mr. Nordwall received his Bachelor of Music Degree in 1970 from the University of Portland studying with Arthur Hitchcock. Additional study was done with Frederick Geoghegan, the noted English/Canadian organist. As a teenager, Jonas had the privilege to study with Richard Ellsasser, one of the greatest virtuoso organist of this century.

Besides serving as Director of Music for the First United Methodist Church in Portland, Oregon and as the Organist for the Oregon Symphony Orchestra.

He has been a featured recitalist for national conventons of the American Theatre Organ Society and was Organist of the year for 1987.

## Music Brains

This is a music creating company established on April 3rd 1992 in Tokyo where it has been mainly working. We make CD's, video BGM, CM, animation music, Karaoke, etc. in our own recording studio. Also, we develop electronic musical instruments, send players, publish manuals, etc. Regarding Roland SMF music data, we have created various titles with the theme of searching reality in music, and have been highly estimated.

Concerning this demonstration data, Yuuki Katoh has composed the gut guitar and Rock guitar data and Kenichiroh Shinzawa has composed the Organ demo under the direction of Takayuki Nagatani, our chief director.

## Scott Tibbs

Scott Tibbs has performed and conducted for several orchestral groups, including the Atlanta Symphony Orchestra, throughout the United States, Canada, Latin America, and Japan. His diverse compositional output ranges from numerous film, theater and television projects to the symphonic concert stage. For the past four years, he has been teaching music composition and theory at UCLA where he has received a Ph.D. degree in composition. He has performed with well-known artists Dizzy Gillespie, Bill Cosby, Jerry Sienfeld, and Bobby Shew, amongst numerous others.

## Scott Wilkie

Scott Wilkie is a keyboardist and composer originally from Detroit, Michigan. His work as a studio musician and sound designer can be heard on many projects.

He has performed live with various artists, including Ronnie Foster, Earl Klugh, Jeff Baxter, David Goldblatt, Ricky Lawson, Mike Miller and others. In addition, he has worked as a synth programmer, most recently for Disney's Broadway production of Beauty and the Beast.

For Roland, Scott appears frequently throughout the United States, Asia, Europe and South America as a clinician and product demonstrator.

Now living in Los Angeles, he performs with his own group and is involved as a musician and producer on various projects.

## Stewart Cary and Joe Millward

Stewart Cary and Joe Millward have been involved in musical performance and production over the last 20 years. Their company, The Works Music Productions, has been producing MIDI files for the last 10 years and was one of the first companies to offer MIDI files to the public. Mr. Cary and Mr. Millward are member of the Roland style development team and have been involved in the composition of numerous product demonstration songs.

# MIDI Implementation Chart

Function...	Transmitted	Recognized	Remarks	
Basic Channel Default Changed	1 1 — 16	1 — 16 1 — 16		
Mode Default Messages Altered	Mode 3 OMNI OFF, POLY *****	Mode 3 Mode 3, 4 (M = 1)	* 2	
Note Number : True Voice	15—113 *****	0 — 127 0 — 127		
Velocity Note ON Note OFF	O X 8n v = 64	O X		
After Touch Key's Ch's	X X	O O	* 1 * 1	
Pitch Bend	O	O	* 1	
Control Change	0, 32 O 1 X 5 X 6, 38 X 7 O 10 X 11 X 64 O 65 X 66 O 67 O 84 O 91 O 93 O 98, 99 X 100, 101 X	O O O O O O O O O O O O O (Reverb) O (Chorus) O O	* 1 * 1 * 1 * 1 * 1 * 1 * 1 * 1 * 1 * 1 * 1 * 1 * 1 * 1 * 1 * 1 * 1 * 1 * 1	Bank Select Modulation Portamento time Data entry Volume Panpot Expression Hold 1 Portamento Sostenuto Soft Portamento control Effect 1 depth Effect 3 depth NRPN LSB, MSB RPN LSB, MSB
Prog Change : True #	0—127 *****	O 0 — 127	* 1 Program Number 1 — 128	
System Exclusive	O	O		
System Common : Song Pos : Song Sel : Tune	X X X	X X X		
System Real Time : Clock : Commands	X X	X X		
Aux Message : All Sounds OFF : Reset All Controllers : Local ON/OFF : All Notes OFF : Active Sensing : System Reset	X X X X O X	O (120, 126, 127) O O O (123 — 127) O X		
Notes	* 1 O X is selectable * 2 Recognize as M = 1 even if M ≠ 1			

Mode 1 : OMNI ON, POLY  
Mode 3 : OMNI OFF, POLY

Mode 2 : OMNI ON, MONO  
Mode 4 : OMNI OFF, MONO

O : Yes  
X : No

# Specification

## Keyboard

88 Keys (Hammer-action mechanism)

## Keyboard Mode

Whole, Split, Layer, Split Arranger (Style Play), Piano Style Arranger, Manual Drum/SFX

## Touch Sensitivity

Super Light, Light, Medium, Heavy, Super Heavy

## Maximum Polyphony

64 notes

## Tones

8 Group 136 Variation  
(Tone Expansion Mode: 300 variation)

## Music Styles

Internal: 120 styles  
Disk: 32 styles

\* *Music Style Disk (MSA) can provide additional Music Style.*

## Manual Drum / SFX Sets

Drum Set: 8 / SFX Set: 1

## Programmable Music Styles

yes

## Effects

Reverb (8types), Chorus (8types), Sympathetic resonance, Rotary (Slow/Fast) and etc.

## Melody Intelligence

18 types

## User Programs

Internal: 32 memories  
Disk: Max,99 sets

## Composer

Tracks: 16 (Easy Mode: 5 tracks)  
Song: 1  
Note Storage: approx.30,000 notes  
Tempo: quarter note = 20 to 250  
Resolution: 120 ticks per quarter note  
Recording Method: Realtime

: Step (on Chord Sequencer Mode)

Playback: Standard MIDI File (Format 0/1), KR Songs  
Save: Standard MIDI File (Format 0), KR Songs

## Edit

Setup, Copy, Quantize, Erase, Delete, Insert, Transpose,  
Track exchange, Track Copy

## Disk Drive / Disk storage

3.5 inch Micro Floppy Disk Drive  
Disk Format : 720K bytes (2DD), 1.44M bytes (2HD)

Songs: Max. 99

Note Storage: approx. 120,000 notes (2DD),  
approx. 240,000 notes (2HD)

## Lyrics

yes

## Languages

4 languages (English, German, French, Japanese)

## Display

240 x 64 dots Graphic LCD with CFL backlighting

## Pedals

Damper, Soft, Sostenuato  
half-pedal recognition: Damper, Soft  
Assignable: Soft, Sostenuato

## Connectors

Output Jacks (mono/stereo)  
Input Jacks (mono/stereo)  
Microphone Jack with Echo  
Headphone Jack (stereo) x 2  
Expression Pedal Jack  
MIDI Connectors (in, out)  
Computer Connector

## Rated Power Output

60 W x 2

## Speakers

20 cm x 2, 5 cm x 2, 5cm x 2 (Monitor)

## Power Supply

AC 117 V, AC 230 V or AC 240V

## Power Consumption

189 W (117 V)/136 W (230 V)/136 W (240 V)

## Finish

Cherry Wood, Oak Wood

## Dimensions

1460 (W) x 548 (D) x 925 (H) mm  
57-1/2 (W) x 21-5/8 (D) x 36-7/16 (H) inches

## Weight

92.4 kg / 203 lbs 12 oz

## Accessories

Owner's Manual  
Music Style Disk (MSA)  
Blank Floppy Disk (MF-2HD)  
Power Cord

\* *In the interest of product improvement, the specifications and/or appearance of this unit are subject to change without prior notice.*

# Index

- A**
  - Advanced .....36
  - Arranger .....21
- B**
  - Balance Slider .....36
  - Basic .....36
  - Bend Range .....67
  - Break .....63
  - Bwd .....25
- C**
  - Chord Intelligence .....38
  - Chord Sequencer .....50
  - Chord Tone .....61
  - Chorus
    - Chorus .....28
    - Chorus Type .....66
  - Composer .....42
- D**
  - Disk Drive .....8, 14
  - Division .....53
- E**
  - Ending .....35
  - Expansion Tones .....67
- F**
  - Fade In/Out .....63
  - Fill In .....37
  - Format .....51
  - Fwd .....25
- G**
  - Glide .....64
- I**
  - Intro .....34
- L**
  - Layer Play .....31
  - Leading Bass .....63
  - Local Control .....68
- M**
  - Marker .....59
  - Melody Intelligence .....40
  - Metronome
    - Metronome .....19
    - Volume/Beat .....58, 66
  - Microphone
    - Echo .....26
    - Volume .....26
  - Minus One Play .....44
  - Mute .....44
- O**
  - Octave Shift .....29
  - One Touch Program
    - Arranger .....21
    - Piano .....19
    - Organ .....20
  - Original .....37
- P**
  - Part Button .....13
- Pedal**
  - Soft, Sostenuto, Dumper .....20
- Piano Style Arranger .....32
- Playback
  - Disk Performances .....24
  - Recorded Performances .....44
- Program Change .....67
- R**
  - Recording .....42
  - Recording Mode
    - Replace .....51
    - Mix .....51
    - Punch In .....51
  - Reverb
    - Reverb .....28
    - Reverb Type .....66
  - Rotary Effect .....20
- S**
  - Save
    - Performance Data .....46
    - SMF Format .....47
    - User Style .....48
    - User Program .....62
  - Song Edit
    - Set Up .....54
    - Quantize .....55
    - Erase .....55
    - Copy .....55
    - Delete .....56
    - Insert .....56
    - Transpose .....56
    - Track Exchange/Track Copy .....57
  - Split
    - Split .....30
    - Split Play .....30
    - Split Point .....30
  - Start (Music Style) .....33
  - Stop (Music Style) .....35
  - Style Composer .....52
  - Style Converter .....53
  - Style Disk .....39
  - Style Play .....21
  - Sync Start .....33
- T**
  - Tempo .....36
  - Track .....42
  - Transpose .....65
  - Tuning
    - Stretch Tuning .....59
    - Temperament .....59
    - Master Tuning .....65
- U**
  - User Style .....52
  - User Program .....62
- V**
  - Variation .....37
- W**
  - Whole Keyboard Play .....29
- 16 Track Sequencer .....49



# Information

When you need repair service, call your local Roland Service Station or the authorized Roland distributor in your country as shown below.

## ARGENTINA

**Instrumentos Musicales S.A.**  
Florida 638  
(1005) Buenos Aires  
ARGENTINA  
TEL: (01) 394 4029

## BRAZIL

**Roland Brasil Ltda.**  
R. Coronel Octaviano da Silveira  
203 05522-010  
Sao Paulo BRAZIL  
TEL: (011) 843 9377

## CANADA

**Roland Canada Music Ltd.**  
(Head Office)  
5480 Parkwood Way Richmond  
B. C., V6V 2M4 CANADA  
TEL: (0604) 270 6626

## Roland Canada Music Ltd.

(Toronto Office)  
Unit 2, 109 Woodbine Downs  
Blvd, Etobicoke, ON  
M9W 6Y1 CANADA  
TEL: (0416) 213 9707

## MEXICO

**Casa Veerkamp, s.a. de c.v.**  
Av. Toluca No. 323 Col. Olivar de  
los Padres 01780 Mexico D.F.  
MEXICO  
TEL: (525) 668 04 80

**La Casa Wagner de  
Guadalajara s.a. de c.v.**  
Av. Corona No. 202 S.J.  
Guadalajara, Jalisco Mexico  
C.P.44100 MEXICO  
TEL: (03) 613 1414

## PANAMA

**Productos Superiores, S.A.**  
Apartado 655 - Panama 1  
REP. DE PANAMA  
TEL: 26 3322

## U. S. A.

**Roland Corporation U.S.**  
7200 Dominion Circle  
Los Angeles, CA. 90040-3696,  
U. S. A.  
TEL: (0213) 685 5141

## VENEZUELA

**Musiclanc Digital C.A.**  
Av. Francisco de Miranda,  
Centro Parque de Cristal, Nivel  
C2 Local 20 Caracas  
VENEZUELA  
TEL: (02) 285 9218

## AUSTRALIA

**Roland Corporation  
Australia Pty. Ltd.**  
38 Campbell Avenue  
Dee Why West. NSW 2099  
AUSTRALIA  
TEL: (02) 982 8266

## NEW ZEALAND

**Roland Corporation (NZ) Ltd.**  
97 Mt. Eden Road, Mt. Eden,  
Auckland 3, NEW ZEALAND  
TEL: (09) 3098 715

## HONG KONG

**Tom Lee Music Co., Ltd.**  
Service Division  
22-32 Pun Shan Street, Tsuen  
Wan, New Territories,  
HONG KONG  
TEL: 2415 0911

## INDONESIA

**PT Galestra Inti**  
Kompleks Perkantoran  
Duta Merlin Blok E No.6—7  
Jl. Gajah Mada No.3—5,  
Jakarta 10130,  
INDONESIA  
TEL: (021) 6335416

## KOREA

**Cosmos Corporation  
Service Station**  
261 2nd Floor Nak-Won Arcade  
Jong-Ro ku, Seoul, KOREA  
TEL: (02) 742 8844

## MALAYSIA

**Bentley Music SDN BHD**  
No.142, Jalan Bukit Bintang 55100  
Kuala Lumpur, MALAYSIA  
TEL: (03) 2443333

## PHILIPPINES

**G.A. Yupangco & Co. Inc.**  
339 Gil J. Puyat Avenue  
Makati, Metro Manila 1200,  
PHILIPPINES  
TEL: (02) 899 9801

## SINGAPORE

**Swee Lee Company**  
BLOCK 231, Bain Street #03-23  
Bras Basah Complex,  
SINGAPORE 0718  
TEL: 3367886

## CRISTOFORI MUSIC PTE

LTD  
335, Joo Chiat Road SINGAPORE  
1542  
TEL: 3450435

## TAIWAN

**Siruba Enterprise (Taiwan)  
Co., LTD.**  
Room. 5, 9fl. No. 112 Chung Shan  
N.Road Sec.2 Taipei, TAIWAN,  
R.O.C.  
TEL: (02) 561 3339

## THAILAND

**Theera Music Co., Ltd.**  
330 Verng Nakorn Kasem, Soi 2,  
Bangkok 10100, THAILAND  
TEL: (02) 2248821

## BAHRAIN

**Moon Stores**  
Bad Al Bahrain Road,  
P.O.Box 20077  
State of BAHRAIN  
TEL: 211 005

## IRAN

**TARADIS**  
Mir Emad Ave. No. 15, 10th street  
P. O. Box 15875/4171 Teheran,  
IRAN  
TEL: (021) 875 6524

## ISRAEL

**Halilit P. Greenspoon &  
Sons Ltd.**  
8 Retzif Ha'aliya Hashnya St.  
Tel-Aviv-Yafo ISRAEL  
TEL: (03) 6823666

## JORDAN

**AMMAN Trading Agency**  
Prince Mohammed St. P. O. Box  
825 Amman 11118 JORDAN  
TEL: (06) 641200

## KUWAIT

**Easa Husain Al-Yousifi**  
P.O. Box 126 Safat 13002  
KUWAIT  
TEL: 5719499

## LEBANON

**A. Chahine & Fils**  
P.O. Box 16-5857 Gergi Zeidan St.  
Chahine Building, Achrafieh  
Beirut, LEBANON  
TEL: (01) 335799

## OMAN

**OHI Electronics & Trading  
Co. LLC**  
P. O. Box 889 Muscat  
Sultanate of OMAN  
TEL: 706 010

## QATAR

**Badie Studio & Stores**  
P.O.Box 62,  
DOHA QATAR  
TEL: 423554

## SAUDI ARABIA

**SAF Music Center**  
AL-Khobar 31952, P. O. Box 1366  
SAUDIARABIA  
TEL: (03) 898 3311

## Abdul Latif S. Al-Ghamdi

Trading Establishment  
Middle East Commercial Center  
Al-Khobar Dharan Highway  
W/hamood st.  
P. O. Box 3631 Al-Khobar  
31952 SAUDIARABIA  
TEL: (03) 898 2332

## SYRIA

**Technical Light & Sound  
Center**  
Khaled Ebn Al Walid St.  
P.O.Box 13520  
Damascus - SYRIA  
TEL: (011) 2235 384

## TURKEY

**Barkat Sanayi ve Ticaret**  
Siraselvler Cad. Guney Ishani No.  
86/6 Taksim, Istanbul TURKEY  
TEL: (0212) 2499324

## U.A.E

**Zak Electronics & Musical  
Instruments Co.**  
Zabeel Road, Al Sherooq Bldg.,  
No. 14, Grand Floor DUBAI  
U.A.E.  
P.O. Box 8050 DUBAI, U.A.E  
TEL: (04) 360715

## EGYPT

**Al Fanny Trading Office**  
9, Ebn Hagar Ai Askalany Street,  
Ard El Golf, Heliopolis, Cairo,  
11341 EGYPT  
TEL: (02) 4171828  
(02) 4185531

## MAURITIUS

**Philanne Music Center**  
4th, Floor Noll, Happy World  
House Sir William Newton Street  
Port Luis MAURITIUS  
TEL: 242 2986

## REUNION

**FO - YAM Marcel**  
25 Rue Jules MermanZL  
Chaudron - BP79 97491  
Ste Clotilde REUNION  
TEL: 28 29 16

## SOUTH AFRICA

**That Other Music Shop  
(PTY) Ltd.**  
11 Melle Street (Cnr Melle and  
Juta Street)  
Braamfontein 2001  
Republic of SOUTH AFRICA  
TEL: (011) 403 4105

**Paul Bothner (PTY) Ltd.**  
17 Werdmuller Centre Claremont  
7700  
Republic of SOUTH AFRICA  
TEL: (021) 64 4030

## AUSTRIA

**E. Dematte & Co.**  
Neu-Rum Siemens-Strasse 4  
A-6040 Innsbruck P.O.Box 83  
AUSTRIA  
TEL: (0512) 26 44 260

## BELGIUM/HOLLAND/ LUXEMBOURG

**Roland Benelux N. V.**  
Houtstraat 1 B-2260 Oevel-  
Westerio BELGIUM  
TEL: (014) 575811

## BELORUSSIA

**TUSHE**  
UL. Mogilovskaja 4/4/175  
220001 MINSK  
TEL: (0172) 252-059

## CYPRUS

**Radex Sound Equipment Ltd.**  
17 Diagorou St., P.O.Box 2046,  
Nicosia CYPRUS  
TEL: (02) 453 426  
(02) 466 423

## DENMARK

**Roland Scandinavia A/S**  
Langebrogade 6 Post Box 1937  
DK-1023 Copenhagen K.  
DENMARK  
TEL: 32 95 3111

## FRANCE

**Guillard Musiques Roland**  
ZAC de Rosarge Les Echets 01700  
MIRIBEL FRANCE  
TEL: 7226 5060

## Guillard Musiques Roland (Paris Office)

1923 rue Léon Geoffroy 94400  
VITRY-SUR-SEINE FRANCE  
TEL: (1) 4680 86 62

## FINLAND

**Roland Scandinavia As,  
Filial Finland**  
Lauttasaarentie 54 B  
Fin-00201 Helsinki, FINLAND  
P. O. Box No. 109  
TEL: (0) 682 4020

## GERMANY

**Roland Elektronische  
Musikinstrumente  
Handelsgesellschaft mbH.**  
Oststrasse 96, 22844 Norderstedt,  
GERMANY  
TEL: (040) 52 60090

## GREECE

**V. Dimitriadis & Co. Ltd.**  
20, Alexandras St. & Bouboulinas  
54 St. 106 82 Athens, GREECE  
TEL: (01) 8232415

## HUNGARY

**Intermusica Ltd.**  
Warehouse Area 'DEPO' Pf.83  
H-2046 Torokbalint, HUNGARY  
TEL: (23) 338 041

## IRELAND

**The Dublin Service Centre  
Audio Maintenance Limited**  
11 Brunswick Place Dublin 2  
Republic of IRELAND  
TEL: (01) 677322

## ITALY

**Roland Italy S. p. A.**  
Viale delle Industrie, 8  
20020 Arese Milano, ITALY  
TEL: (02) 93581311

## NORWAY

**Roland Scandinavia Avd.  
Kontor Norge**  
Lilleakerveien 2 Postboks 95  
Lilleaker N-0216 Oslo  
NORWAY  
TEL: 273 0074

## POLAND

**P. P. H. Brzostowicz Marian**  
UL. Blokowa 32, 03624 Warszawa  
POLAND  
TEL: (022) 679 44 19

## PORTUGAL

**Caius - Tecnologias Audio e  
Musica, Lda.**  
Rue de Catarina 131  
4000 Porto, PORTUGAL  
TEL: (02) 38 4456

## RUSSIA

**PETROSHOP Ltd.**  
11 Sayanskaya Street Moscow  
11531, RUSSIA  
TEL: 095 901 0892

## SPAIN

**Roland Electronics  
de España, S. A.**  
Calle Bolivia 239 08020 Barcelona,  
SPAIN  
TEL: (93) 308 1000

## SWEDEN

**Roland Scandinavia A/S**  
Danvik Center 28 A, 2 tr.  
S-131 30 Nacka SWEDEN  
TEL: (08) 702 0020

## SWITZERLAND

**Roland (Switzerland) AG  
Musitronic AG**  
Gerberstrasse 5, CH-4410 Liestal,  
SWITZERLAND  
TEL: (061) 921 1615

## UKRAINE

**TIC-TAC**  
Mira Str. 19/108  
P.O.Box 180  
295400 Munkachevo, UKRAINE  
TEL: (03131) 414-40

## UNITED KINGDOM

**Roland (U.K.) Ltd., Swansea  
Office**  
Atlantic Close, Swansea  
Enterprise Park SWANSEA  
West Glamorgan SA7 9FJ,  
UNITED KINGDOM  
TEL: (01792) 702701



For the USA

## FEDERAL COMMUNICATIONS COMMISSION RADIO FREQUENCY INTERFERENCE STATEMENT

This equipment has been tested and found to comply with the limits for a Class B digital device, pursuant to Part 15 of the FCC Rules. These limits are designed to provide reasonable protection against harmful interference in a residential installation. This equipment generates, uses, and can radiate radio frequency energy and, if not installed and used in accordance with the instructions, may cause harmful interference to radio communications. However, there is no guarantee that interference will not occur in a particular installation. If this equipment does cause harmful interference to radio or television reception, which can be determined by turning the equipment off and on, the user is encouraged to try to correct the interference by one or more of the following measures:

- Reorient or relocate the receiving antenna.
- Increase the separation between the equipment and receiver.
- Connect the equipment into an outlet on a circuit different from that to which the receiver is connected.
- Consult the dealer or an experienced radio/TV technician for help.

Unauthorized changes or modification to this system can void the users authority to operate this equipment.  
This equipment requires shielded interface cables in order to meet FCC class B Limit.

For Canada

### **CLASS B NOTICE**

This digital apparatus does not exceed the Class B limits for radio noise emissions set out in the Radio Interference Regulations of the Canadian Department of Communications.

### **CLASSE B AVIS**

Cet appareil numérique ne dépasse pas les limites de la classe B au niveau des émissions de bruits radioélectriques fixés dans le Règlement des signaux parasites par le ministère canadien des Communications.

 Roland®

1905 - 770

UPC

1905 - 770



10981

Roland Corporation

1905 - 770A

