

SYNTHESIZER

# SH-1 INSTRUCTIONS

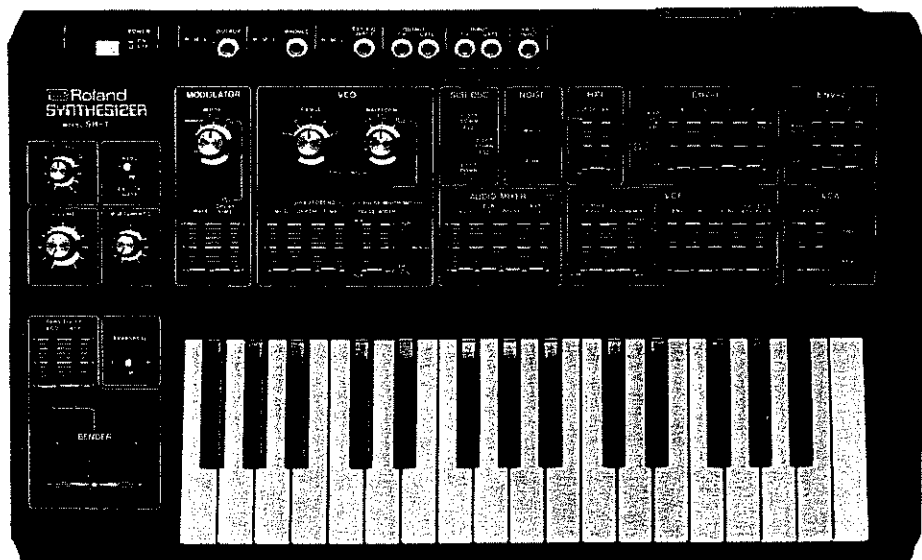

The SH-1 incorporates a sub-oscillator which adds a one- or two-octave lower pitch to the note played, thus widely expanding the sound.

The newly developed VCO and VCF guarantees stabilized pitch and tone quality.

The SH-1 is provided with an envelope follower to make synthesizer-like sounds from any type of sound source. It is also provided with a bender lever which greatly helps solo performance.

The SH-1 features versatile functions like those found on larger synthesizers and it is designed to be compact and easily operable even by beginners.

# PRECAUTIONS AND CONNECTION

## PRECAUTIONS

- Avoid using the synthesizer in very high or low temperature locations. Also keep it away from heaters and coolers since this type of equipment tends to affect circuit and pitch stability.
- Avoid using the synthesizer in very dusty or high-humidity places.
- If it is necessary to play the synthesizer in an area with neon or fluorescent lamps, keep the synthesizer as far away from these lamps as possible since they will induce high levels of noise. Sometimes, changing the angle of the synthesizer in relation to the lamps will help reduce noise.
- When connecting the synthesizer, plug the cord into the external amplifier first, then the other end into the SH-1 output. To disconnect, remove the cord from the synthesizer first, then from the amplifier.
- To clean the synthesizer, wipe with a cloth dampened with a neutral cleanser. Do not use solvents such as paint thinner.

## • COMBINING WITH ELECTRONIC ORGAN

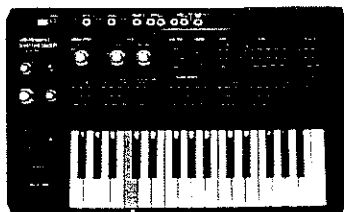

\*Tune to unison with middle C on the organ.

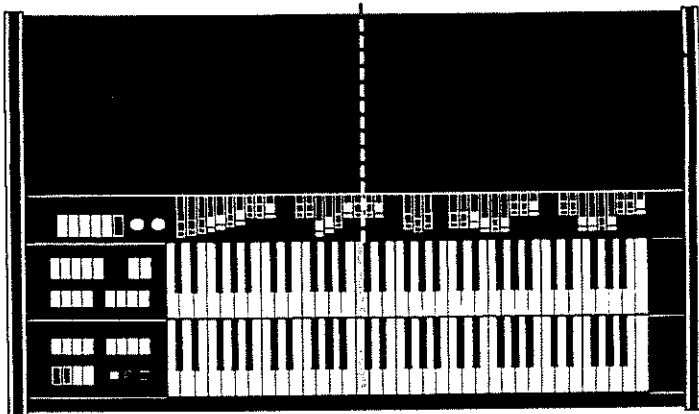

When playing an electronic organ in combination with the SH-1, set the units as illustrated above.

## • CONNECTING TO AMP

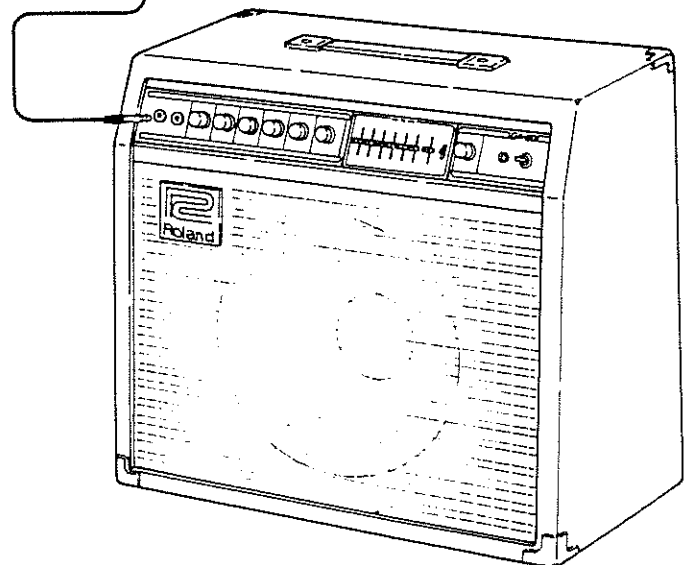
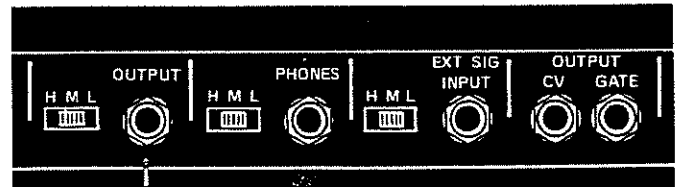

Connecting the SH-1 to an amplifier.

# CONTROLS AND BLOCK DIAGRAM

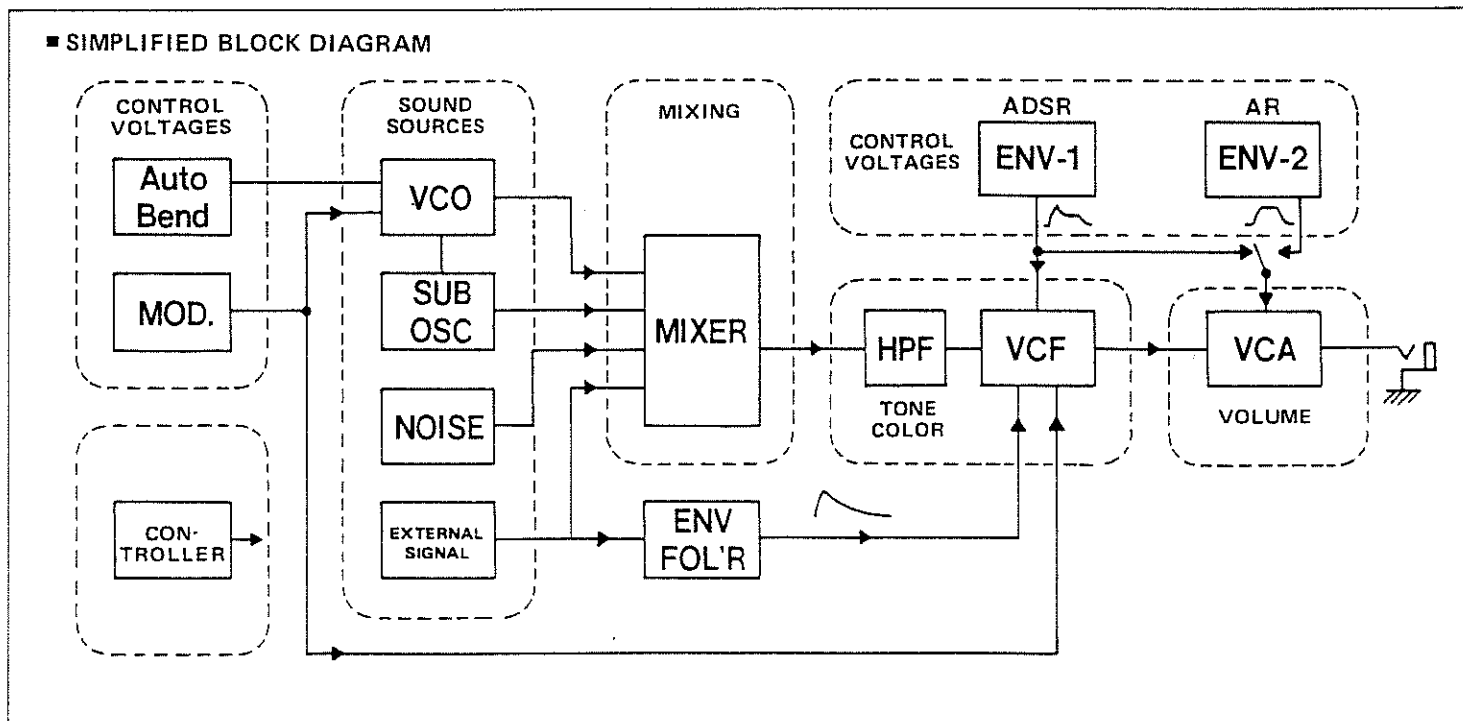
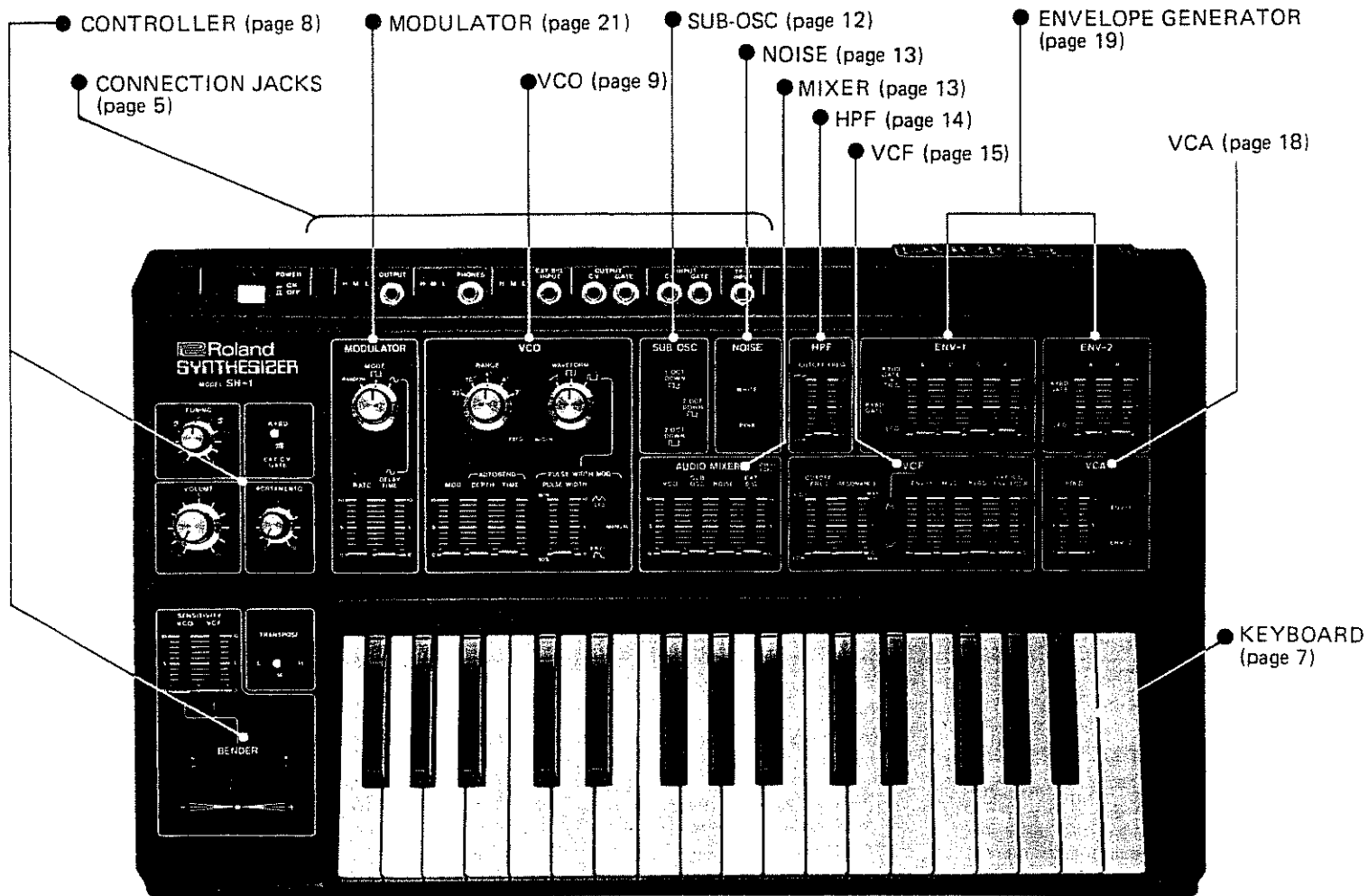

# THE ABC'S OF THE SYNTHESIZER

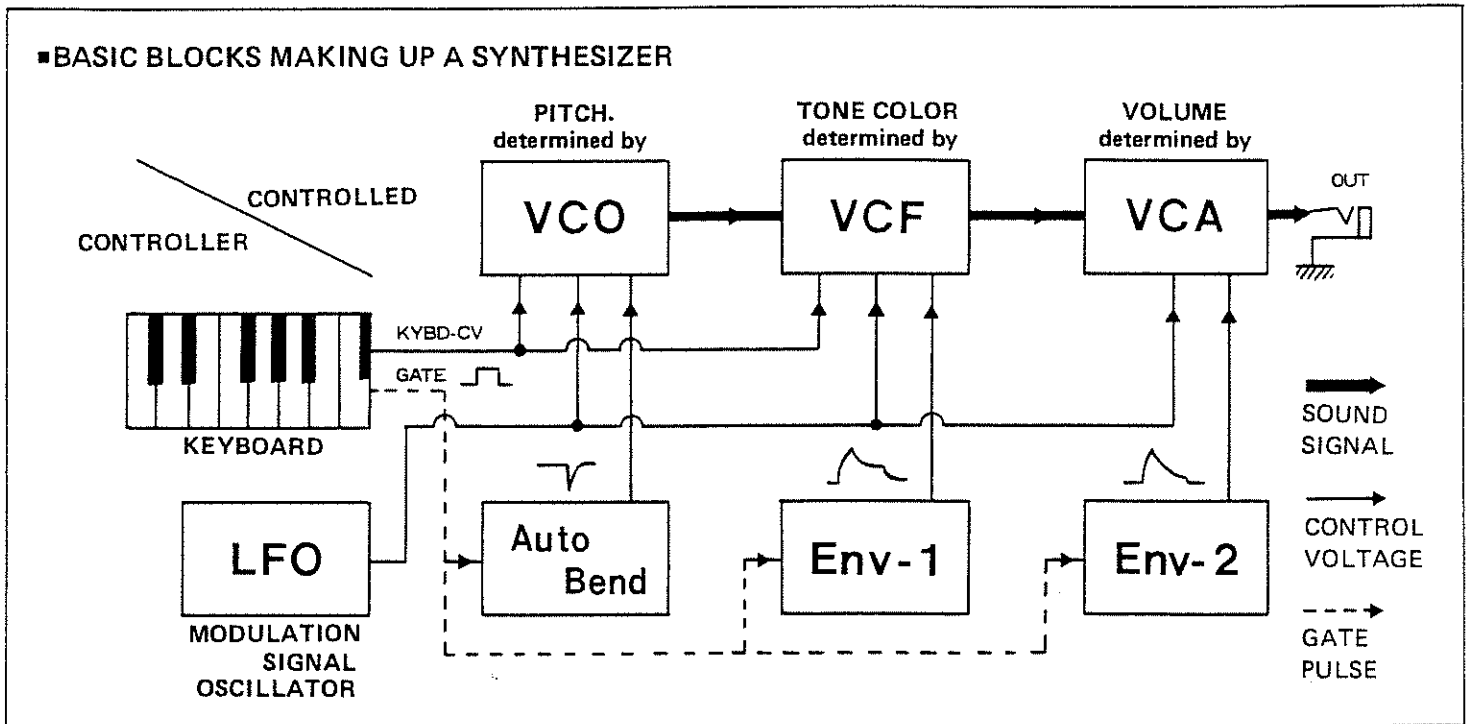

## ■ THE THREE QUALITIES OF SOUND

The three qualities of sound are: pitch, tone color, and loudness.

Sound is the result of physical vibration in objects. The pitch produced depends on the vibration rate. Fig. 1 shows that the higher the vibration rate, or the higher the frequency of the vibrations, the higher the pitch is. Frequency is measured in unit called the Hertz (Hz). If a sound source vibrates at a rate of 100 vibrations per second, it is said to have a frequency of 100Hz. The normal human ear can hear sounds with frequencies from about 20Hz to about 16,000Hz.

In synthesizers, pitch is controlled by the VCO (Voltage Controlled Oscillator). An oscillator is an electronic circuit which generates a waveform, or in this case, sound. Voltage controlled means that a voltage is used to control the frequency (pitch, in this case) of the oscillator; the higher the voltage, the higher the frequency. This, then, is the first quality of sound: pitch.

Fig. 1 shows what are known as sine waves, the simplest mode of vibration. The sound of a sine wave is very clean and pure. Most sound sources vibrate at many frequencies at the same

time, however. The lowest of the vibrations, and usually the strongest, is the one which we hear as the musical pitch of the sound source. The presence of these other frequencies is what gives a sound source its second quality: tone color.

The frequencies produced by the complex vibrations of a sound source are called harmonics. Harmonics are usually multiples of the pitch frequency. For example, consider a sound source which vibrates so as to produce a pitch with a frequency of 200Hz. The first harmonic would be 200Hz ( $1 \times 200 = 200$ ). The first harmonic is also called the fundamental because this is the frequency which gives the sound its musical pitch. The second harmonic would be  $2 \times 200$ , or 400Hz. The third harmonic would be  $3 \times 200$ , or 600Hz; the fourth harmonic  $4 \times 200$ , or 800Hz, etc.

Fig. 2 shows a square wave. Square waves produce a tone color much like that of a clarinet. Square waves contain only the odd numbered harmonics, or in other words, those frequencies which are one, three, five, nine, etc. times the frequency of the fundamental, or pitch frequency. The even numbered harmonics are missing. Tone color, then, is determined by the harmonic

content of the sound; the more harmonics there are, the brighter the tone color. In the synthesizer, tone color is controlled by the VCF (Voltage Controlled Filter). The VCO produces a basic sound wave rich in harmonics. The VCF is used to remove (or filter out) some of these harmonics thus controlling the harmonic content of the finished sound. The amount of the harmonics removed is controllable by a control voltage.

The third quality of sound, loudness, is determined in a synthesizer by the level or amplitude of the waveform, as shown in Fig. 3, and is controlled by the VCA (Voltage Controlled Amplifier).

The loudness of a sound changes during its production. Strike a piano key and the sound jumps the maximum loudness. Hold the key down and the sound slowly dies away. This pattern of loudness in a sound is called its envelope. The output of the envelope generator is a control voltage. This control voltage is used to control the VCA, thus shaping the loudness pattern of the output sound of the synthesizer.

FIG. 1 — SOUND PITCH = FREQUENCY

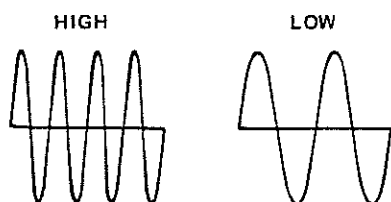

FIG. 2 — TONE COLOR = HARMONICS CONTENT

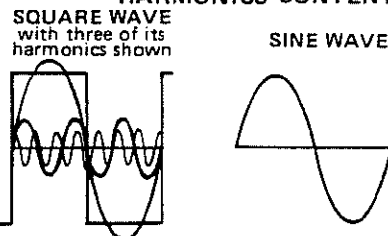
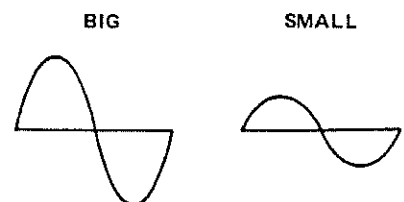
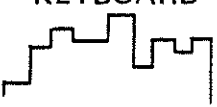



FIG. 3 — VOLUME = AMPLITUDE



CONTROLLED CONTROLLER	VCO PITCH = FREQUENCY	VCF TONE COLOR = HARMONIC CONTENT	VCA LOUDNESS = AMPLITUDE
<b>KEYBOARD</b> 	The most common use of the keyboard control voltage is for the control of the pitch of a VCO; the pitch produced will correspond to the key pressed.	The tone color of most instruments will vary with pitch; higher pitches often produce brighter tone colors, lower pitches darker tone colors. For this purpose, the VCF can be controlled by the keyboard.	The control of loudness by means of the keyboard is of little practical use; the SH-1 has no provision for this type of control.
<b>ENVELOPE</b> 	With some sounds, it is desirable to incorporate pitch changes during the production of each note. The SH-1 contains a special envelope generator (autobend) provided exclusively for this purpose.	The tone color of many instruments, particularly the wind instruments, changes during the production of each note. This effect can be produced with envelope generator control of the VCF. Raising the VCF RESONANCE control will produce sounds possible only on the synthesizer.	The loudness pattern (or articulation) of a sound is produced by using the output of the envelope generator to control the VCA.
<b>LFO (MODULATOR)</b> 	The LFO (Low Frequency Oscillator) produces low frequency wave forms. Using the LFO sine wave output to control the pitch of the VCO will produce vibrato effects. The LFO square wave output will produce trills.	With some sounds, the tone color will vary at the same rate as vibrato. This can be done with LFO control of the VCF. Raising the VCF RESONANCE control will produce "growl" effects.	The SH-1 does not provide for LFO control of the VCA; however, the square wave output of the LFO can be used for triggering the envelope generators to produce rapidly repeating notes.

### ■ BASIC SYNTHESIZER THEORY

In the synthesizer, then, the three qualities of sound are controlled by the VCO (pitch), VCF (tone color), and VCA (loudness). The tremendous versatility of the synthesizer is due to the principle of voltage control. The above table shows some of the possibilities.

The keyboard has two outputs: a control voltage and a gate pulse. The level of the control voltage will correspond to the last key pressed. The control voltage output is most often used to control the frequency of the VCO, thus, when a key is pressed, the VCO will produce the pitch which is related to that key. The keyboard produces a gate pulse each time a key is pressed. The gate pulse is most often used to trigger the envelope generator into operation. The control voltage output of the envelope generator, then, "opens" the VCA to let the sound wave out, thus the synthesizer produces sound each time a key is depressed.

The shape of the envelope is controlled by the envelope generator sliders. When the sliders are set, the envelope generator will generate a control voltage which corresponds to the shape of the desired envelope. When this control voltage controls the VCA, it regulates the loudness level

of the sound so that the loudness will rise and fall in the desired pattern. Fig. 4 shows the output sound wave when the envelope generator controls are set to produce a violin-like envelope, and Fig. 5 shows the output sound wave for a piano-guitar-like envelope.

The tone color of many types of sound will often change during the production of each note. This can be done with the synthesizer by using the output of the envelope generator to control the VCF.

There are two other sources of control voltage: the LFO (Low Frequency Oscillator) and the S/H (Sample and Hold), each of which can be used to control various synthesizer functions.

In the following pages, the functions of each of the synthesizer elements is explained in detail. When trying various sounds, try to analyze exactly what is happening; this will give you a better understanding of the synthesizer. Synthesizer sounds are very much enhanced by the use of effects units such as echo chambers, reverberators, chorus effects, phase shifters, flangers, etc, thus their use is highly recommended.

FIG. 4 - VIOLIN-LIKE SOUND

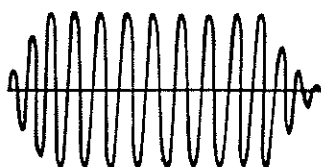

FIG. 5 - PIANO-LIKE SOUND

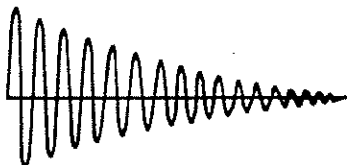
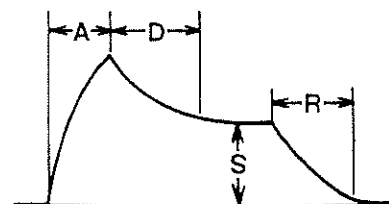
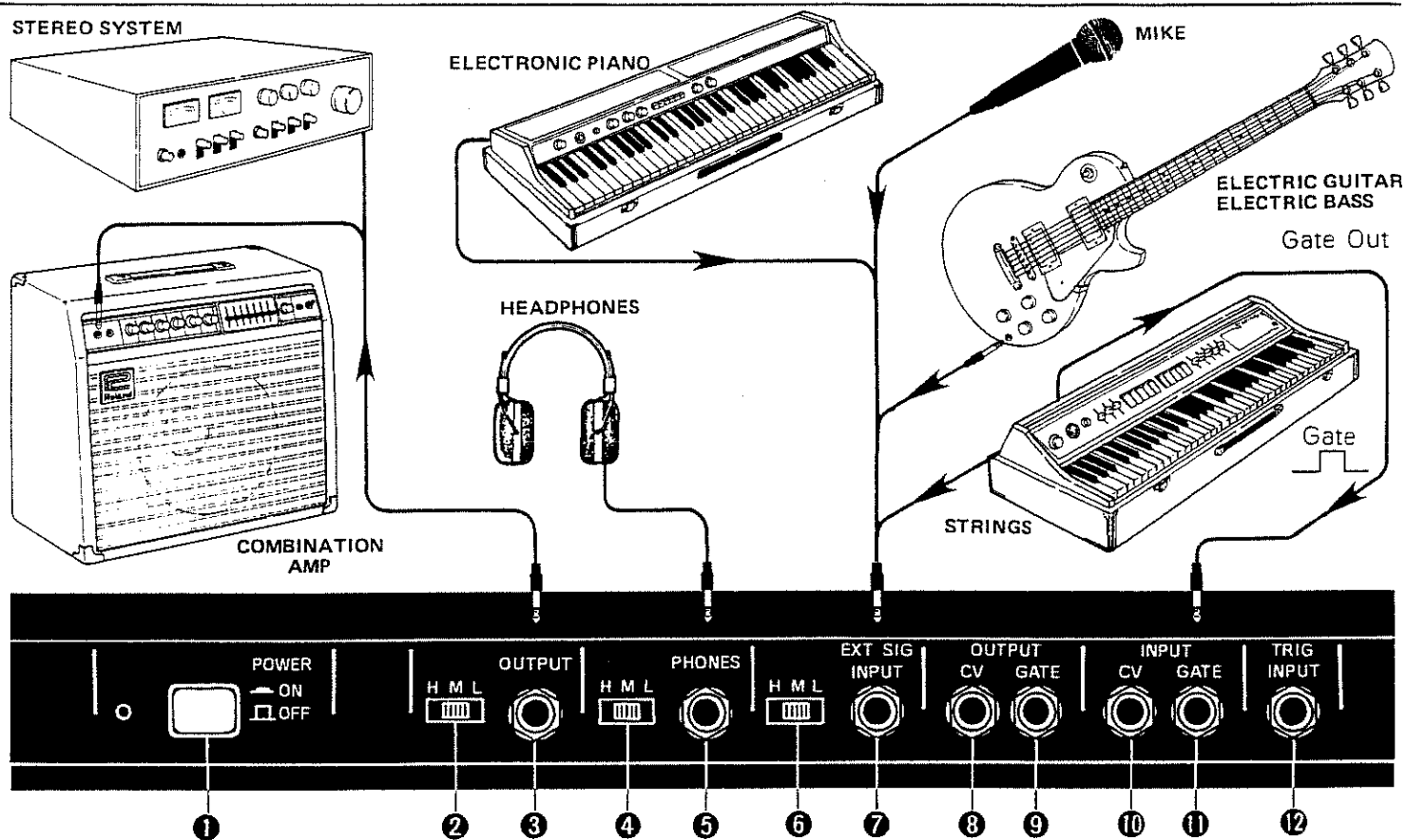

FIG. 6 - PARTS OF ENVELOPE



# CONNECTION METHODS - BASIC

## STEREO SYSTEM



### 1. POWER SWITCH

Push the Power switch and the LED (light emitting diode) will light, indicating the SH-1 is on.

NOTE: It requires about five minutes for the SH-1 circuits to completely stabilize. Keep this point in mind when using the SH-1 on stage or in recording sessions.

### 2. OUTPUT LEVEL

Set this switch to L, M, or H according to the input sensitivity of the amplifier used. Set to L or M for an ordinary guitar amplifier and to H for an audio amplifier or mixer.

### 3. OUTPUT

Connect to guitar amplifier, mixer, or audio amplifier. If you use an effects unit like an echo chamber, connect it between the output jack and the amplifier. When using audio amplifiers such as those in home stereo systems, use caution with the volume control because the synthesizer is capable of generating sound levels high enough to destroy the speakers.

### 4. PHONES OUTPUT LEVEL

This switch changes the output level at the PHONES jack. Set it at the position to suit the sensitivity of the headphones you use.

### 5. PHONES JACK

Connect headphones to this jack. Use headphones designed for normal home stereo systems. Roland RH-1 headphones

are suited for this purpose. The output level from this jack is constant, independent of the TOTAL VOLUME setting; therefore, you can turn down the volume from the speaker when adjusting sounds with the headphones. This is very convenient for setting sounds on stage.

### 6. EXT SIG INPUT LEVEL

This is a level changeover switch for the external input. Set to H for microphone, to M or H for an electric or electronic instrument. When connecting a tape recorder or other audio devices, set to L.

If the output level is low even when the EXT SIG control on the AUDIO MIXER is set to maximum, set the EXT SIG INPUT switch a step higher. If the sound is distorted by excessive input, change to a step lower.

### 7. EXT SIG INPUT

Connect external sources such as a microphone, electric guitar, electric piano, or strings to this jack.

As the SH-1 incorporates an envelope follower, the VCF can be controlled by the level of the signal from the external source to use the SH-1 as a kind of effects unit like automatic wah. When connecting the strings such as the Roland RS-202, connect the gate output also to make it possible to control the envelope generator of the SH-1 from the strings keyboard. With this setting, the VCF can be activated on brass chords producing sounds like a

polyphonic synthesizer.

### 8. CV OUTPUT

This jack outputs the control voltage from the SH-1 keyboard. Connect to the CV input of an external synthesizer or the MC-8 MicroComposer to control such devices with the SH-1 keyboard.

### 9. GATE OUTPUT

The gate output from the SH-1 keyboard can be taken from this jack. Connect to the gate input of an external synthesizer or the MC-8 MicroComposer for control of such devices with the SH-1 keyboard.

### 10. CV INPUT

In the same way as the Gate Input, control voltages from external sources can be connected to this jack.

When connecting external control voltages to control the SH-1, be sure to set the KEY MODE switch to EXT position. (See page 8, No. 2).

### 11. GATE INPUT

This jack receives gate pulses from sources such as the VK-6 or VK-9 Organ, the Model 104 (System 100) or Model 717A (System 700) Analog Sequencer, the MC-8 MicroComposer, the RS-202 String Synthesizer, etc.

### 12. TRIG INPUT

This jack receives external trigger pulses. When a +15V pulse is fed to this jack, the SH-1 gate is triggered.

# CONNECTION METHODS - APPLICATION

## 1. SH-1 + EXTERNAL SYNTHESIZER (SYSTEM 100 - Model 101/102, SYSTEM 700, SH-7)

When the SH-1 is connected with the System 700, System 100 (Model 101/102), SH-7, etc. the external synthesizer can be controlled from the SH-1 keyboard. It is also possible to control the SH-1 from the keyboard of the external synthesizer. Combined playing by two SH-1's is also effective.

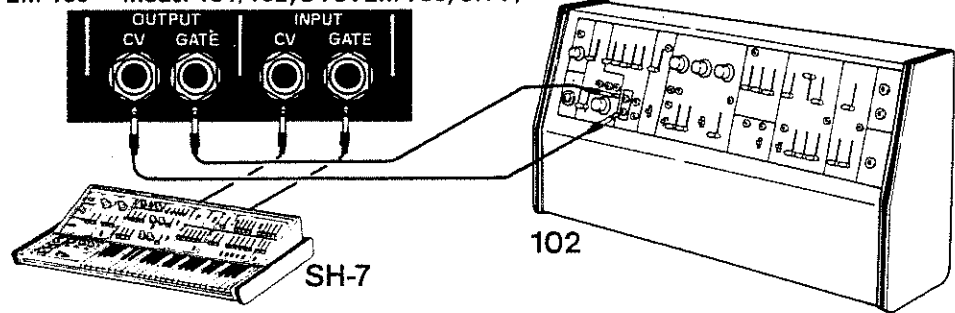

## 2. SH-1 + SEQUENCER (SYSTEM 700 - Model 717A, SYSTEM 100 - MODEL 104)

When the SH-1 is connected to an analog sequencer like the System 700 Model 717A or System 100 Model 104, automatic performance is possible. When using the System 700, up to 36 notes can be stored, and with the Model 104, up to 24 notes can be stored.

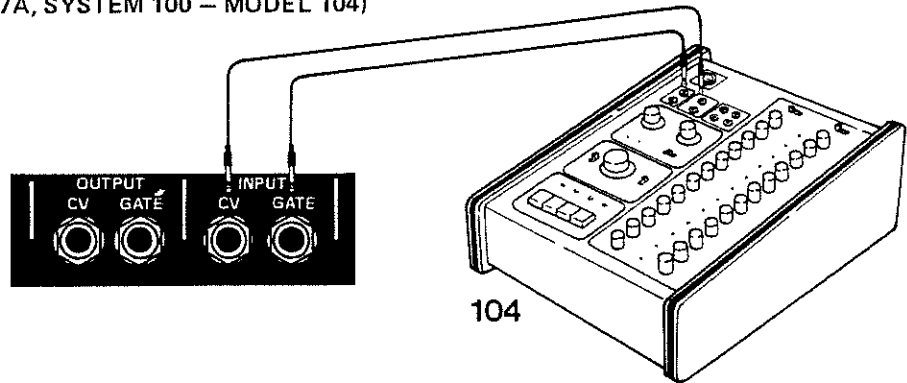

## 3. SH-1 + MICROCOMPOSER (MC-8)

When the SH-1 is combined with the MC-8 Microcomposer, performance of more than 5,300 notes can be carried out automatically. The note pitch and rhythm can be stored by use of the ten-keys. It is also possible to play the SH-1 to store the pitch and rhythm directly in the MC-8. When eight SH-1's are used with the MC-8, eight voices can be automatically played simultaneously.

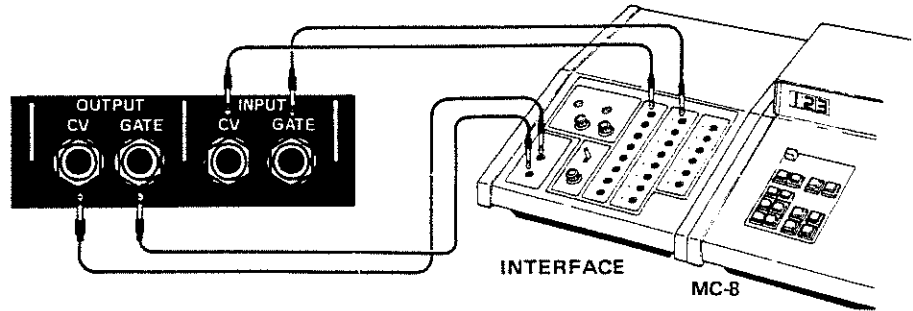

## 4. SH-1 + GUITAR SYNTHESIZER GR-500

When the SH-1 and GR-500 Guitar Synthesizer are combined, the SH-1 can be played using the GS-500 Guitar Controller.

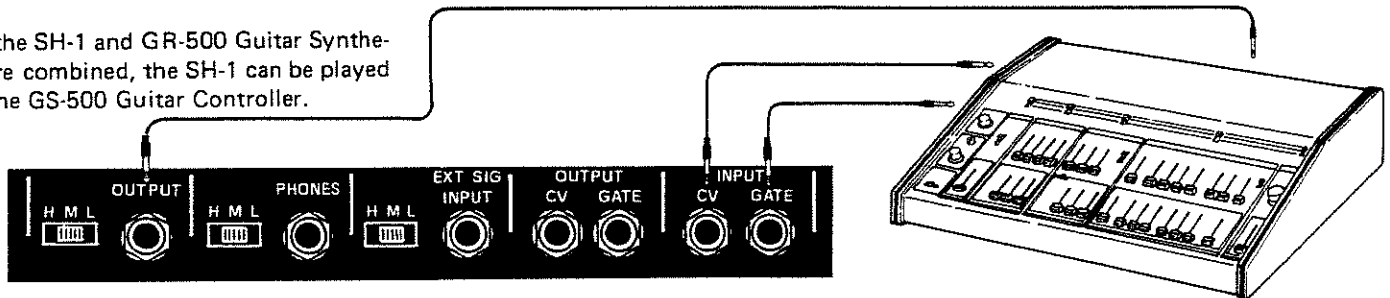

## 5. SH-1 + ORGAN VK-9/6

When the SH-1 and Organ VK-9/6 are combined, the SH-1 synthesizer sound can be produced by the upper manual of the organ, together with the organ sound.

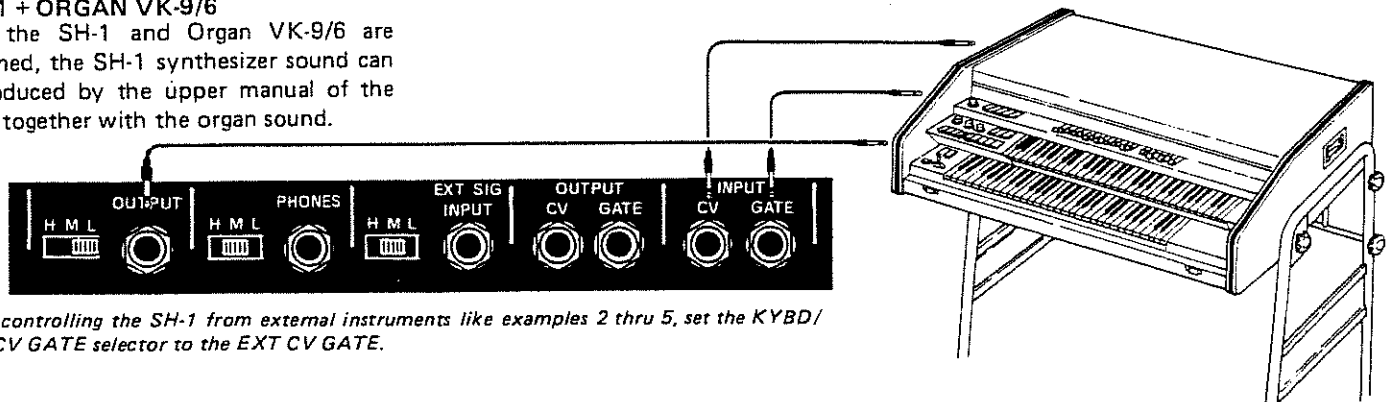

\* When controlling the SH-1 from external instruments like examples 2 thru 5, set the KYBD/EXT CV GATE selector to the EXT CV GATE.

# KEYBOARD

## ■KEYBOARD

The SH-1 keyboard has 32 keys for a range of 2-1/2 octaves, but by use of the VCO RANGE switch and with the CONTROLLER section TRANSCOPE switch, the SH-1 has a total pitch range of over eight octaves.

With the RANGE switch at 8' and the TRANSCOPE switch at M, the lowest C on the keyboard corresponds to middle C on the piano.

## ■KEYBOARD VOLTAGE

The keyboard produces a control voltage which corresponds to the key pressed. This control voltage is most often used to control a VCO so that it produces the pitch related to the key pressed.

The SH-1 uses the relation of 1 volt/1 octave (one volt per octave) which means that a one volt change in the control voltage will produce a one octave change in pitch.

The relation is very common and is used on most synthesizers and related equipment, including professional studio equipment as well as stage type equipment. This means that the SH-1 is compatible with most equipment used in all forms of electronic music.

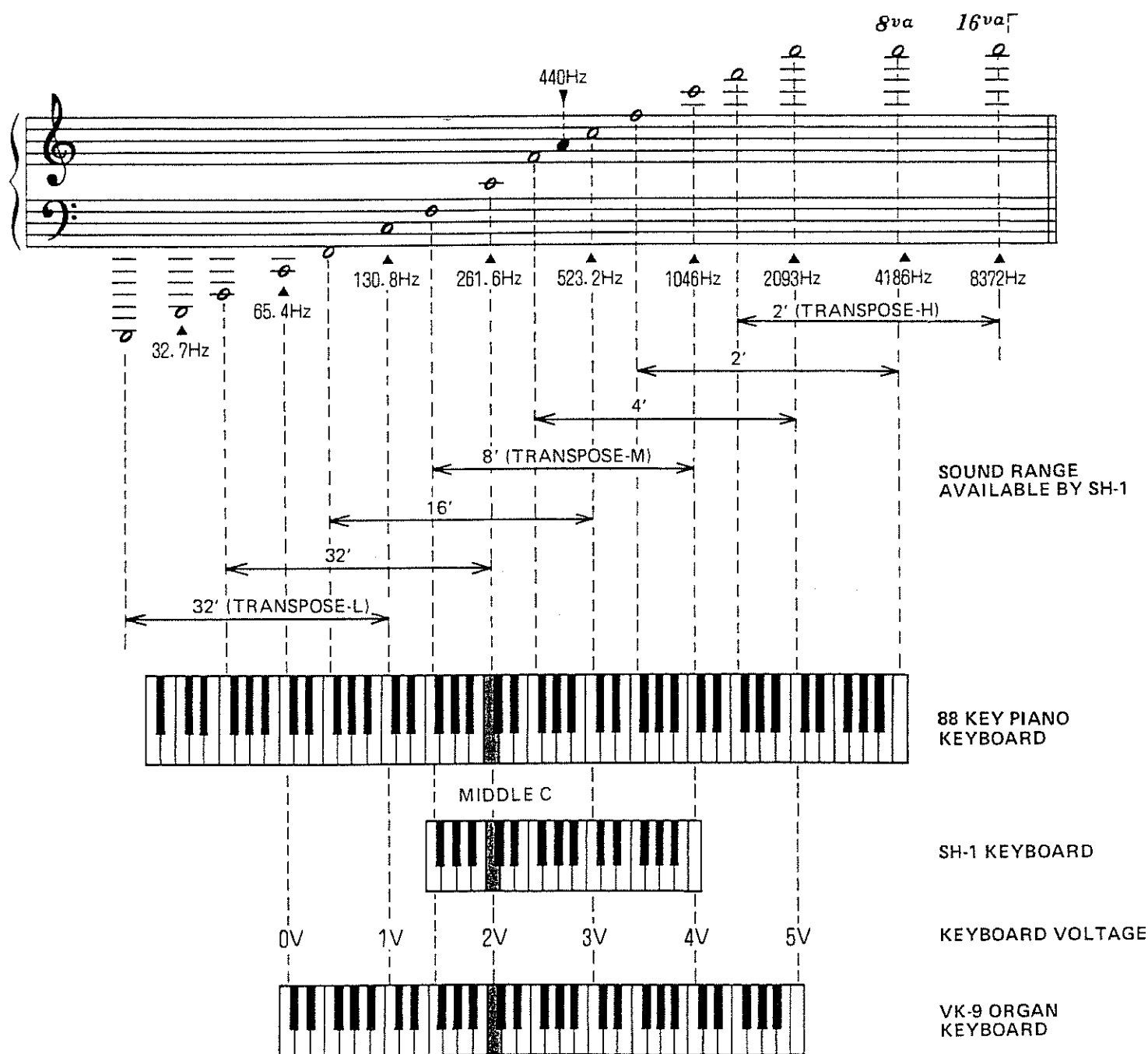



# CONTROLLER

## 1. TUNING

This controls the overall pitch of the SH-1. The tunable range is  $\pm 700$  cents (700 cents = perfect fifth), thus if C were the center pitch, the range would be from the F below to the G above. With this feature, the SH-1 can play transposing parts such as for trumpet or saxophone without having to rewrite the parts or transpose mentally. When first turning the SH-1 on, be sure to allow enough time for the circuits to stabilize before trying to tune accurately.

## 2. CV/GATE SELECTOR SWITCH

Set the selector switch to EXT CV/GATE when controlling the SH-1 with external signals from an organ, guitar, second synthesizer, sequencer, computer, string synthesizer (RS-202), etc.

In performance, this switch is convenient because it allows instant changes of control of the SH-1 between control by its own keyboard or from an external source.

When nothing is connected to the GATE and CV INPUT jacks, control will always be from the SH-1 keyboard no matter what the switch position is.

## 3. VOLUME

This controls the total volume of the output sound from SH-1. Changing the tone color by means of the VCF sometimes causes a change in the volume of sound. In such cases, the volume should be adjusted with this knob.

## 4. PORTAMENTO

Portamento is the sliding of a note from one pitch to another. The synthesizer is the only keyboard instrument which can produce portamento effects. Through the effective use of the SH-1 portamento feature you can create portamento effects like those sometimes used with trombone and violin playing.

The PORTAMENTO knob controls the time required for the change of pitch. As this knob is turned clockwise, the portamento time is increased. At the extreme counterclockwise position no portamento is in effect.

## 5. TRANSPOSE SWITCH

The TRANSPOSE switch transposes the keyboard pitches up or down one octave. L = LOW range; M = MIDDLE range, and H = HIGH range.

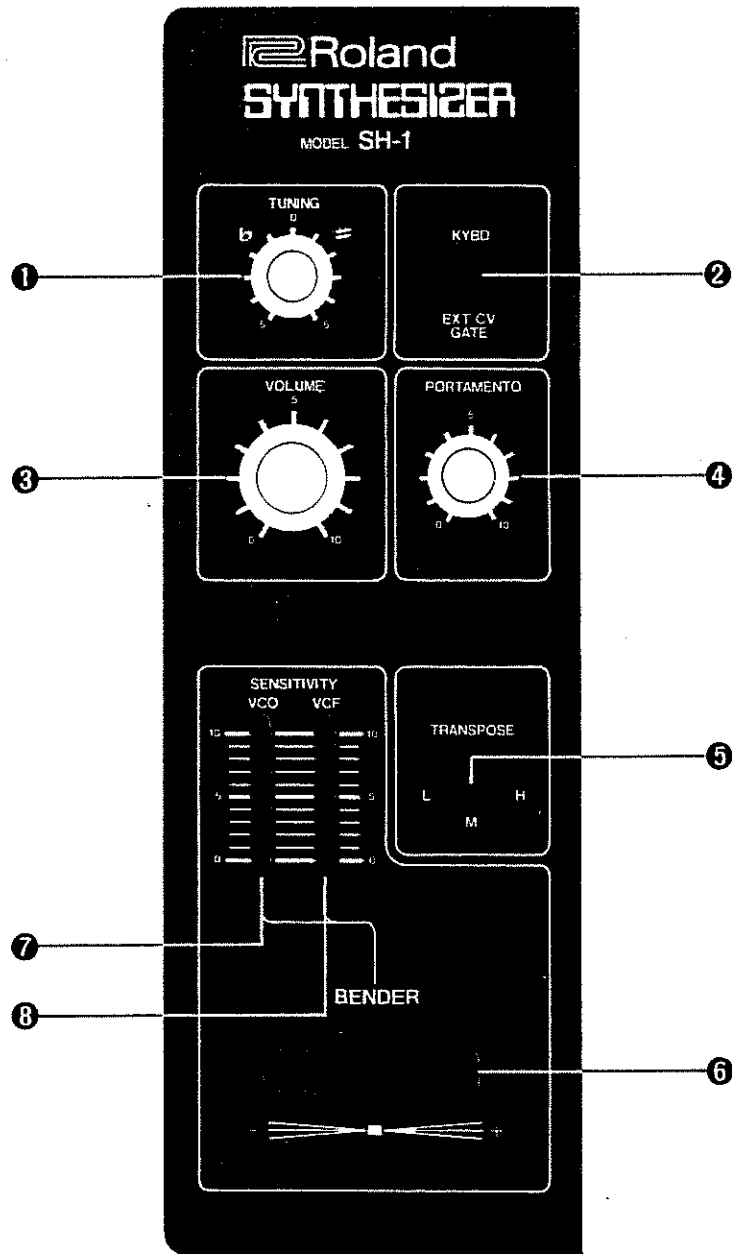

## 6. BENDER

This section functions for changing the pitch, tone color, or volume by means of the BENDER lever (6). The BENDER variation of the pitch is very effective for imitation of guitar choking.

The BENDER lever controls the bend effects. It has a click-stop at center with a spring return to center. When using the BENDER for control of LFO depth, the lever may be moved in either direction, the effect is the same.

## 7. SENSITIVITY SLIDER (VCO)

This slider controls the pitch variation range induced by the bender. At maximum, it is possible to get a  $\pm$ one octave variation. Set at around "2" for normal bending.

## 8. SENSITIVITY SLIDER (VCF)

This slider controls the tone color variation range induced by the bender. At the upper position, wah pedal effects are imitated by moving the bender lever. If the VCF CUTOFF frequency is set high, the tone color variation may be poor even when the lever is moved with the VCF Sensitivity slider at high position.

# VCO - VOLTAGE CONTROLLED OSCILLATOR

## ■ VCO (Voltage Controlled Oscillator)

The VCO is the primary sound source of the synthesizer and generates the basic waveforms. The frequency or pitch of these waveforms is controlled by a control voltage.

## ■ VCO CONTROL VOLTAGE INPUTS

The most important control of VCO pitch is by means of the keyboard control voltage and the BENDER control voltage. The keyboard control voltage is internally connected to the VCO. The BENDER control voltage is connected through the BENDER SENSITIVITY control.

Other sources of control voltage for control of the VCO are: MOD (Modulator) and AUTOBEND voltage, and the S/H. Each of these may be fed to the VCO in the amounts needed to produce the desired effects.

### 1. MOD (Modulator or LFO)

With the MOD slider at high position, the VCO is modulated by the output signals of Modulator. The VCO pitch will vary as shown in (1), (2), and (3) at the right, depending on the setting of the Modulator MODE switch.

(1) Pitch varies continuously to give vibrato effects.

(2) Pitch varies as in a trill.

(3) Pitch varies irregularly to give random notes.

### 2. AUTOBEND DEPTH

This control adds a change of pitch at the beginning of each note played. By raising this control, the VCO pitch is controlled by a voltage envelope as shown in (4) so that the sound starts with a lower pitch. The human voice, whistling, and other sound sources which begin on lower pitches will sound more real and natural using this.

### 3. AUTOBEND TIME

This controls the time required for the VCO to return to its normal pitch when using the AUTOBEND. Raising the slider increases the time. Normally, this slider is set between 0 and 5; special effects are obtained with higher settings.

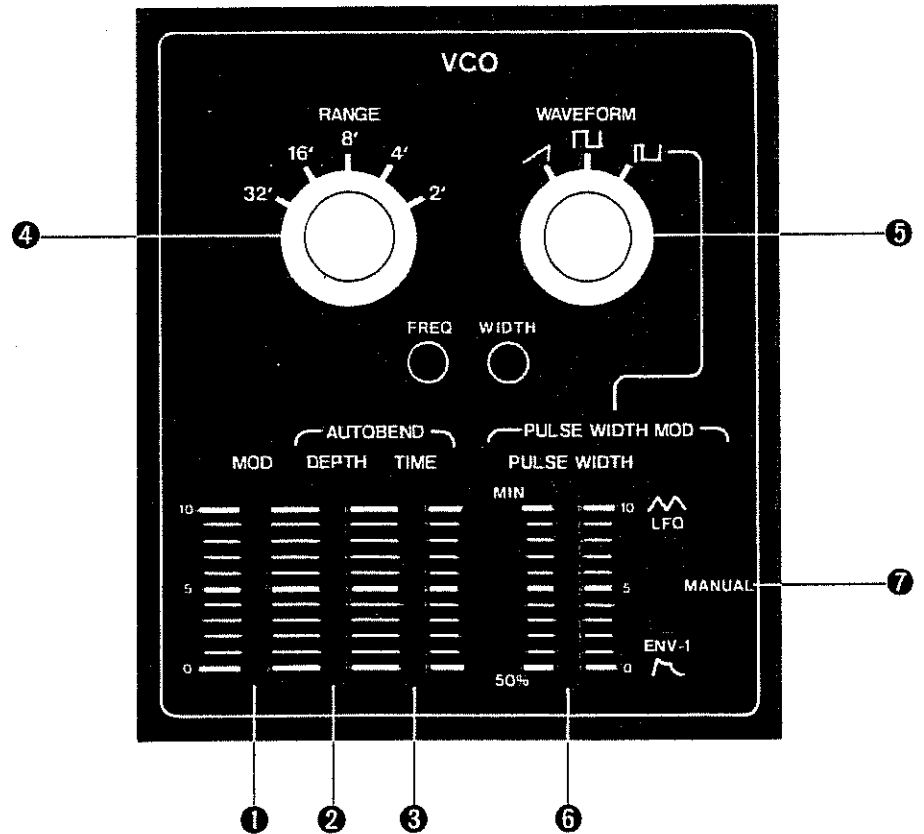

(1) MOD. (~~~~)

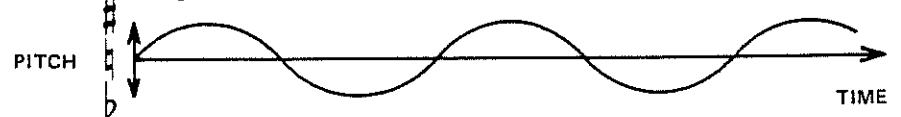

(2) MOD. (□□)

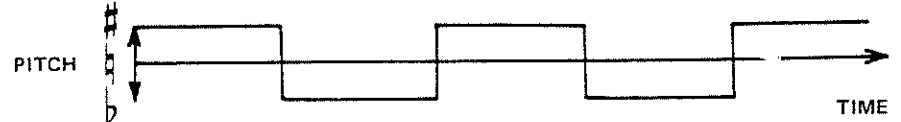

(3) MOD. (Random)

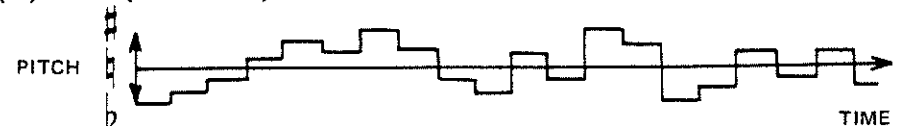

(4) AUTOBEND

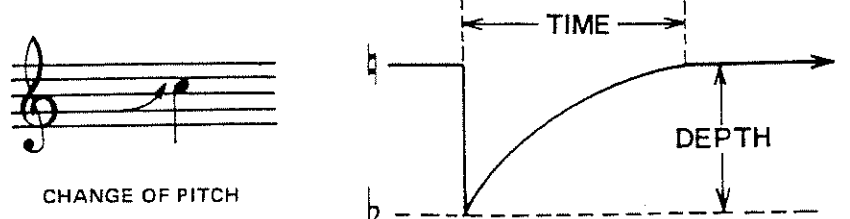

#### 4. RANGE SWITCH

This switch changes the VCO range in one octave jumps from 2' to 32', for a total range of five octaves. The 8' position of the RANGE switch is used for sounds in the middle sound range; the lowest C on the keyboard will produce the pitch of middle C. The 4' position produces pitches in the range one octave above 8', and the 2' position produces pitches two octaves above 8'. The 16' and 32' positions produce pitches one and two octaves below 8' respectively.

#### 5. WAVEFORM SWITCH

This switch selects the VCO output waveform.

##### (1) SAWTOOTH WAVEFORM ( / )

The sawtooth wave is very rich in harmonics and therefore is used very often. It is particularly suitable for brass and string sounds, and for sounds which only the synthesizer can produce.

##### (2) SQUARE WAVE ( □ )





The square wave is also rich in harmonics, but it contains only the odd numbered harmonics. The pure square wave has a sound quality very much like a clarinet. The clarinet and xylophone are common sounds synthesized with this waveform, as well as sounds peculiar to the synthesizer. One effect which is very often used is the continuous sound of the square wave (without envelope control) accompanied by portamento.

##### (3) PULSE WAVE ( ▭ )

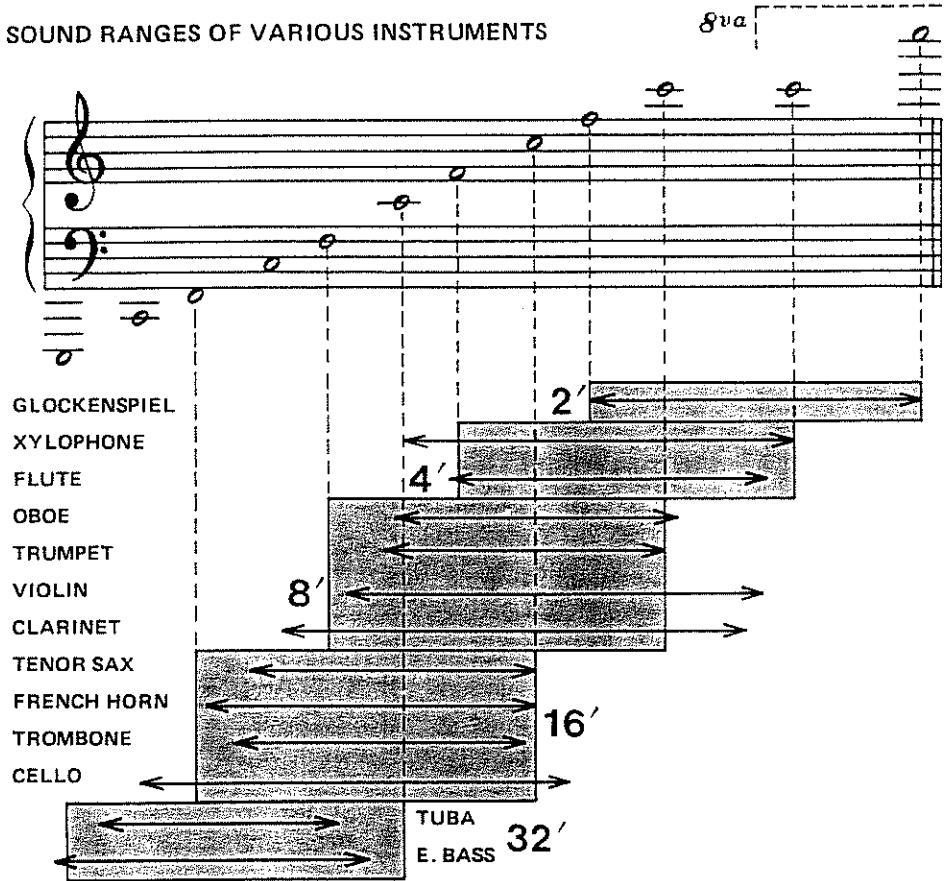
When the top and bottom portions of the square wave are unequal, the result is what is called a pulse wave. The harmonic content of the pulse wave will depend greatly on the width of the pulses. It is possible to modulate, or change the pulse width by means of the LFO or the envelope generator.

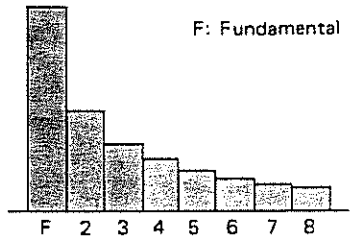
#### ■ SOUND RANGES OF VARIOUS INSTRUMENTS

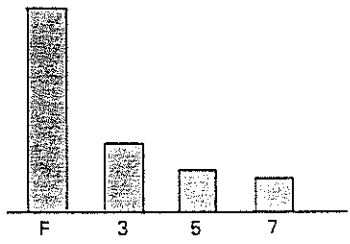

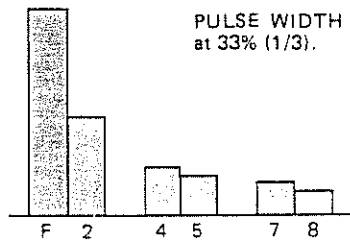
WAVEFORM	DESCRIPTION	HARMONIC CONTENT
 <p>SAWTOOTH</p>	<p>The sawtooth wave contains a fundamental sine wave and its integral harmonic sine waves at a fixed ratio. The level of each harmonic is as shown on the right. When fundamental content is 1, the content of <math>n</math>th harmonic is <math>1/n</math>.</p>	 <p>F: Fundamental</p>
 <p>SQUARE</p>	<p>The square wave contains a fundamental sine wave and its odd numbered harmonics at a fixed ratio. The level of each harmonic is the same as sawtooth wave: the content of <math>n</math>th harmonic is <math>1/n</math>; except that there are no even numbered harmonics.</p>	
 <p>PULSE</p>	<p>With pulse wave, the harmonic content greatly varies depending on the pulse width. It is characterized by a lack of the <math>n</math>th harmonic series when the pulse width is <math>1/n</math>. The example on the left lacks 3rd, 6th, and 9th harmonics because the pulse width is <math>1/3</math> (33%).</p>	 <p>PULSE WIDTH at 33% (1/3).</p>

# VCO - VOLTAGE CONTROLLED OSCILLATOR

## 6. PULSE WIDTH AND PULSE WIDTH MODULATION

Pulse width refers to the ratio of the widths of the top and bottom portions of the pulse wave. Pulse width is measured in percentages as shown in the drawing at the right. 10% pulse width produces a sound very rich in harmonics and is often used for synthesizing sounds such as the oboe, bassoon, and human voice. Note that a 50% pulse width is nothing more than a square wave.

In addition to using fixed pulse widths, it is possible to modulate the pulse wave so that the width of the pulses varies continually, as shown in the drawing at the right.

Using the LFO to modulate the pulse width produces chorus-like sounds. The output of the envelope generator can be used to modulate the pulse width to produce sounds very much like those of pizzicato strings.

With the PWM MODE switch at MANUAL, this control allows manual adjustment of the pulse width. Note that the lowest position, 50%, will produce a square wave. At the top is MIN (minimum) which produces a pulse width of about 10%.

With the PWM MODE switch set at LFO or ENV-1, this slider controls the depth of the LFO or ENV-1 modulation.

## 7. PWM MODE SWITCH

With this switch at MANUAL, the pulse widths may be set manually by means of the PULSE WIDTH MOD slider. In LFO, the pulse width will be modulated by the LFO output, and in ENV-1, by the output of ENVELOPE GENERATOR 1.

(1) PULSE WIDTH WAVEFORM

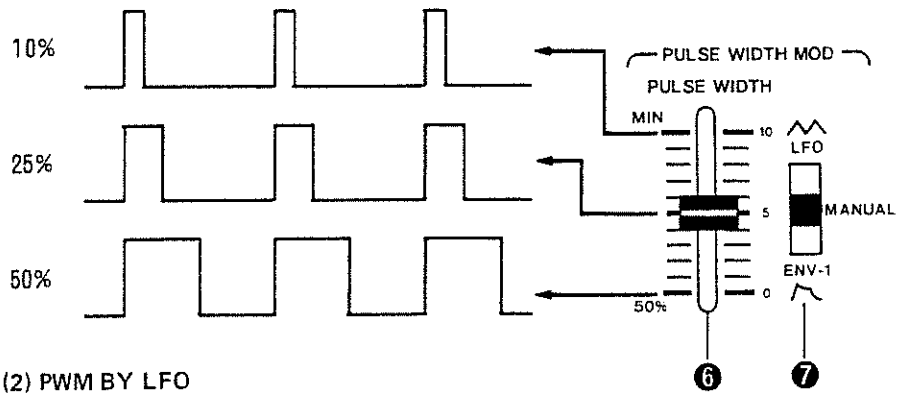

(2) PWM BY LFO

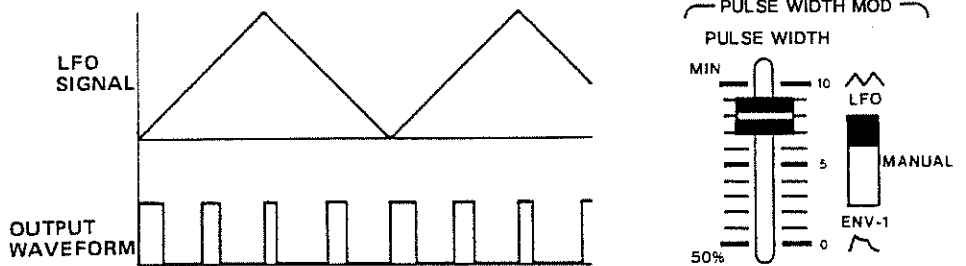

(3) PWM BY ENV-1

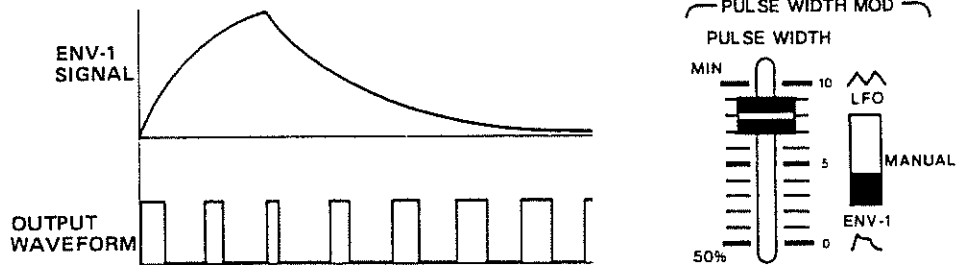

## WAVEFORMS AND HARMONICS

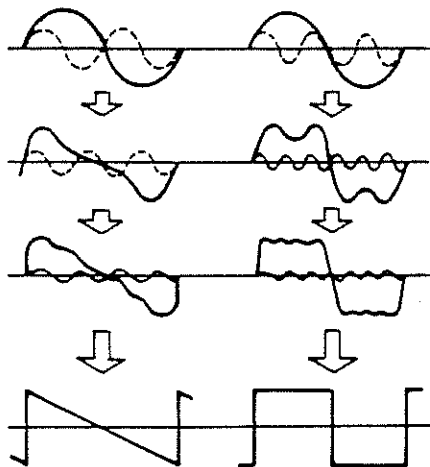

All waveforms except the sine wave can be generated by a combination of a fundamental sine wave of the pitch frequency and a group of sine waves which are multiples of the fundamental; therefore, any waveform can be synthesized by combining a fundamental sine waveform with a proper ratio of harmonics.

The drawing below shows a funda-

mental with its harmonics. The white notes are even numbered harmonics and the black notes are odd numbered harmonics. (True harmonics are actually slightly different from the pitches produced by the equally tempered scale.) All waveforms, except the sine wave, contain harmonics. It is this harmonic content that gives each sound its particular tone color.

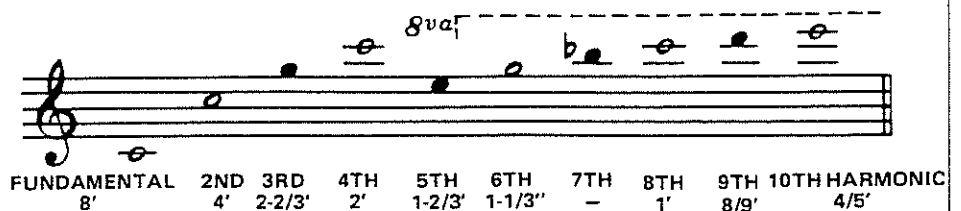

# SUB-OSCILLATOR

## Sub-oscillator

The sub-oscillator is actually a part of the VCO and generates a pitch one- or two-octaves lower than that of the VCO.

Three types of waves are available: a one-octave lower square wave, a two-octave lower square wave and a two-octave lower pulse wave.

Mixing the sub-oscillator output with the VCO output will give new dimensions to your sound, as if two VCO's were used.

Figure (1) shows the combination of a PWM wave from the VCO and a one-octave lower square wave, which can be used to synthesize accordion or organ sounds.

Figure (2) shows the combination of a square wave from the VCO and a two-octave lower square wave, which can be used to synthesize vibraphone sounds.

Figure (3) shows the combination of a pulse wave from the VCO and a two-octave lower pulse wave, which produces very heavy sounds suited for rock music and effective for ad-lib performance.

The correct adjustment of the AUDIO MIXER controls is very important since the sound will vary greatly with different balances.



### 1. 1 OCT DOWN (ACCORDION, ETC. See page 34.)

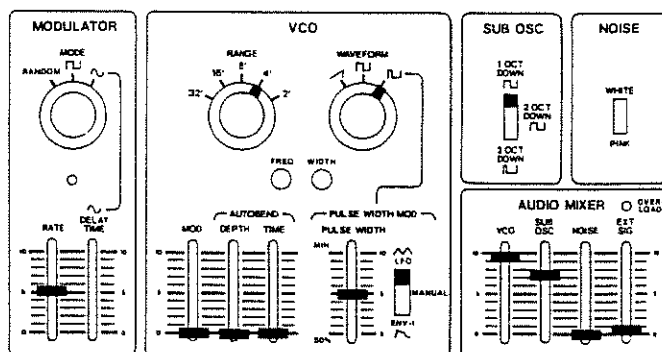
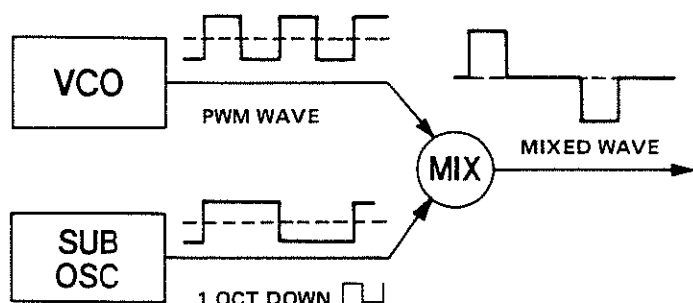

### 2. 2 OCT DOWN (VIBRAPHONE, ETC. See page 35.)

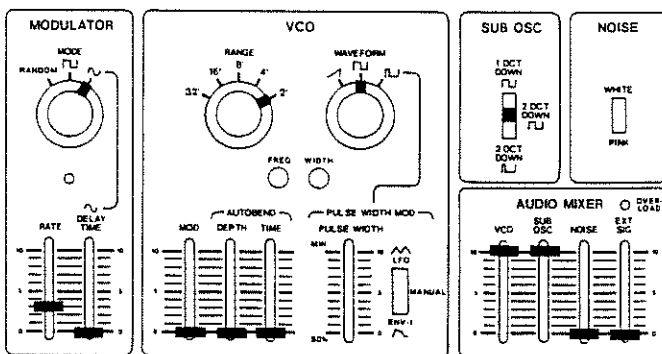
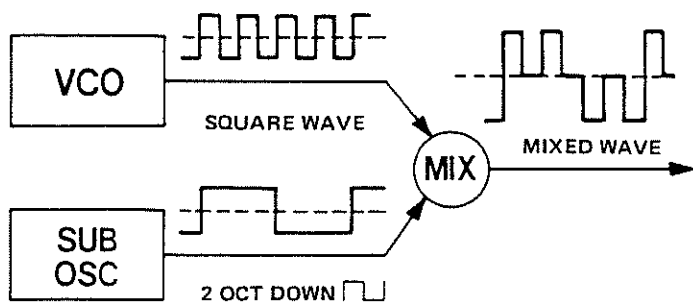

### 3. 2 OCT DOWN (VERY HEAVY SOUND FOR ROCK. See page 37.)

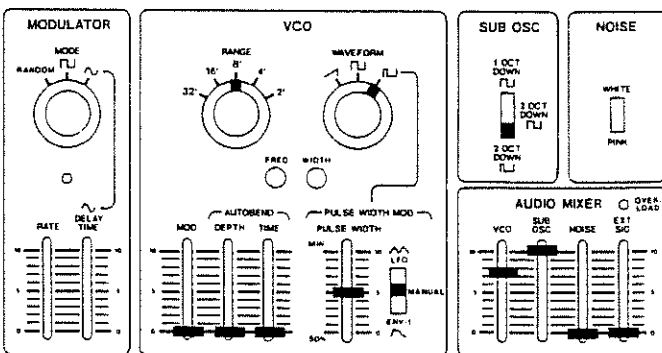
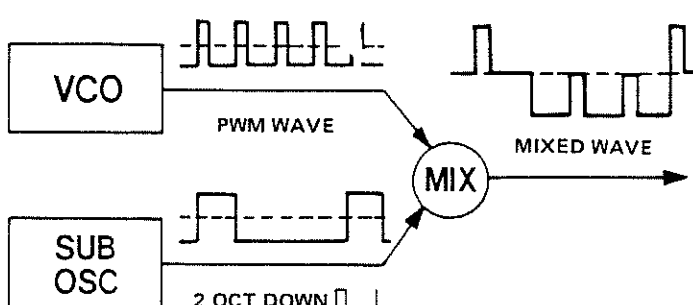

# NOISE GENERATOR AND AUDIO MIXER

## ■ NOISE GENERATOR

The NOISE GENERATOR is used as the sound source for effect sounds like wind, surf, and thunder.

Two types of noise are available: white noise and pink noise.

White noise is the random combination of all frequencies. This kind of noise is like the hissing sound which can be heard when an FM tuner is set at a point where there is no station broadcasting. Pink noise is similar, but has some of the higher frequencies filtered out to produce a sound more like a waterfall.

The random notes of the MOD (Modulator) are due to irregularly changing voltages produced by sampling the noise wave.

## ■ AUDIO MIXER

This mixer mixes outputs of the VCO, Sub-oscillator, Noise Generator, and the external input signal.

The OVERLOAD indicator lights when the external level is excessively high. The indicator is not related to the position of EXT SIG slider. Keep the external signal level so that the overload indicator goes on at the peak volume.

## ■ NOISE WAVEFORM

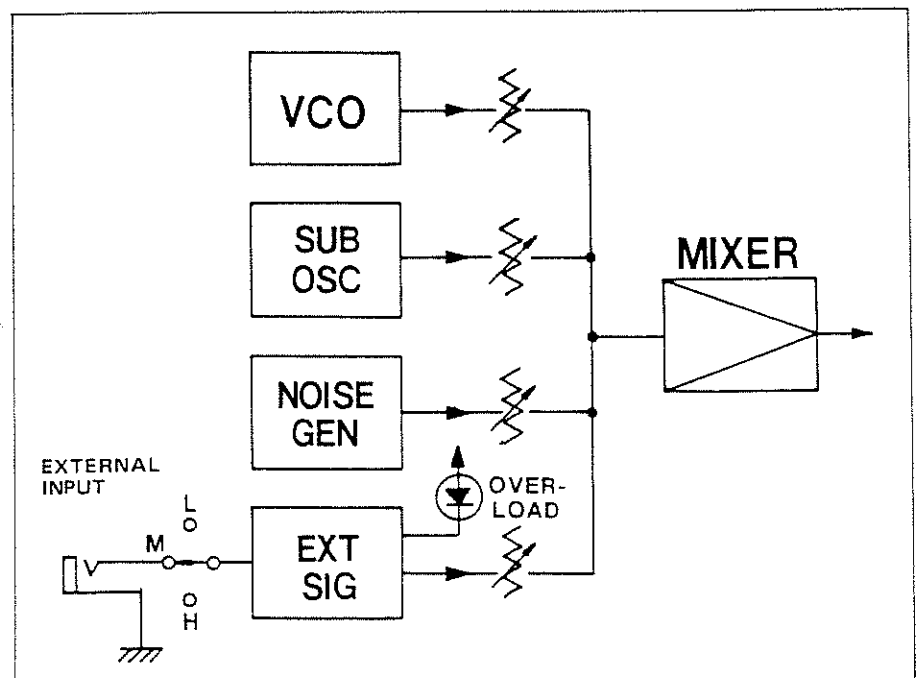
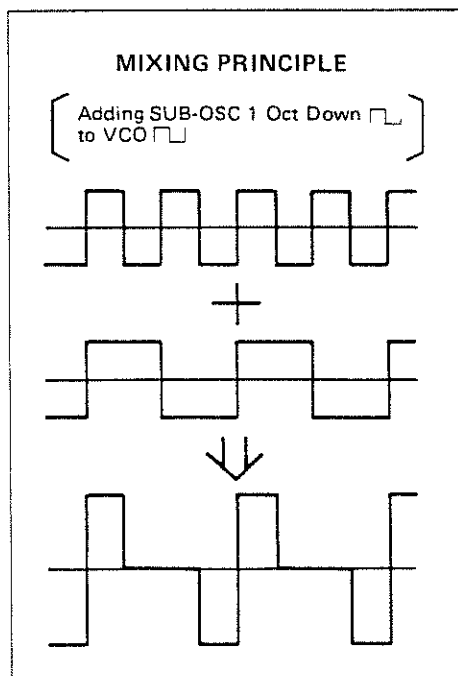
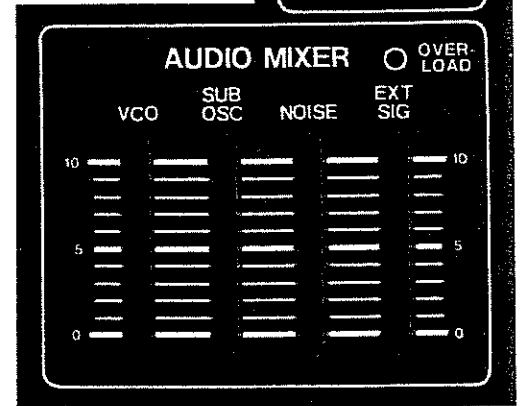
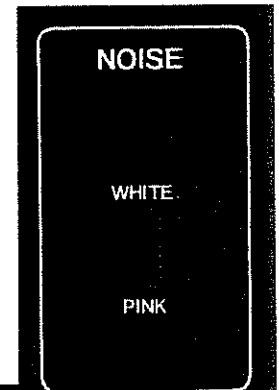
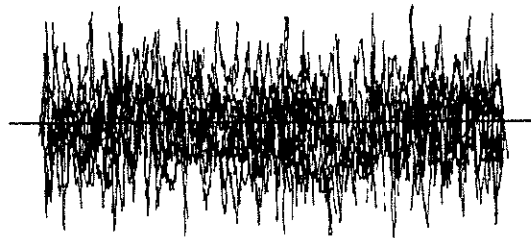

# HIGH PASS FILTER

## ■ HIGH PASS FILTER

Before entering the VCF, the signals mixed in the AUDIO MIXER pass through the HPF (High Pass Filter). The HPF blocks low frequencies and passes high frequencies. With the CUTOFF FREQ control at its lowest position, all sounds pass through the HPF without change; this may be thought of as its normal position. When the CUTOFF FREQ control is raised, the HPF will remove the lower harmonics from the sound source, thus brightening the sound. It is normal for higher positions of this control to produce lower levels of output sound; compensate for this by raising the VOLUME control.

The HPF can be used for synthesizing harpsichord and oboe sounds, for example.

## ■ WAVEFORM CHANGES IN THE HPF

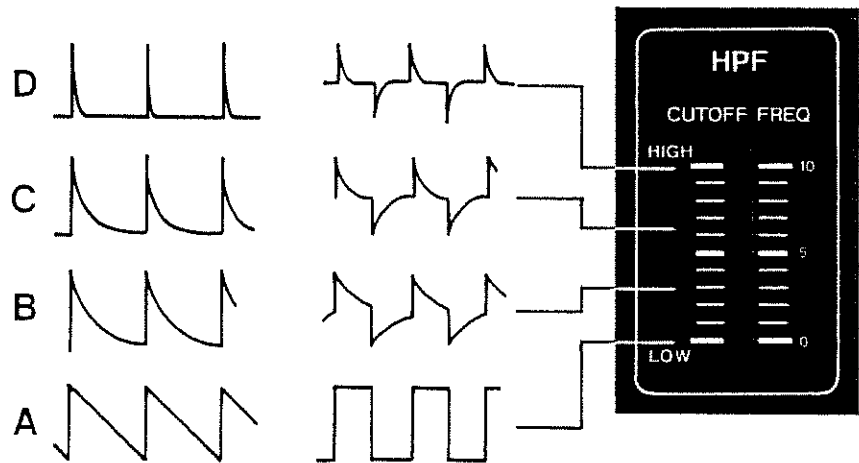

## ■ HPF FREQUENCY RESPONSE

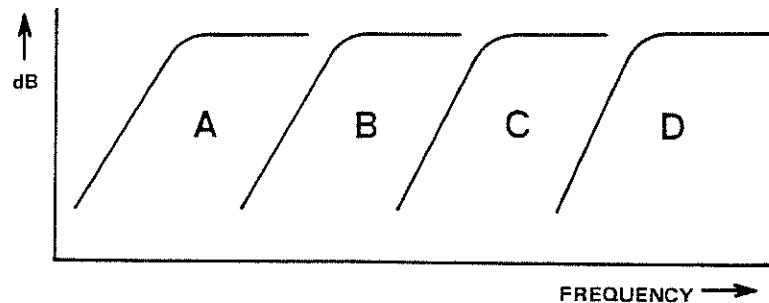

## ACTION TO BE TAKEN WHEN DESIRED SOUND CANNOT BE PRODUCED.

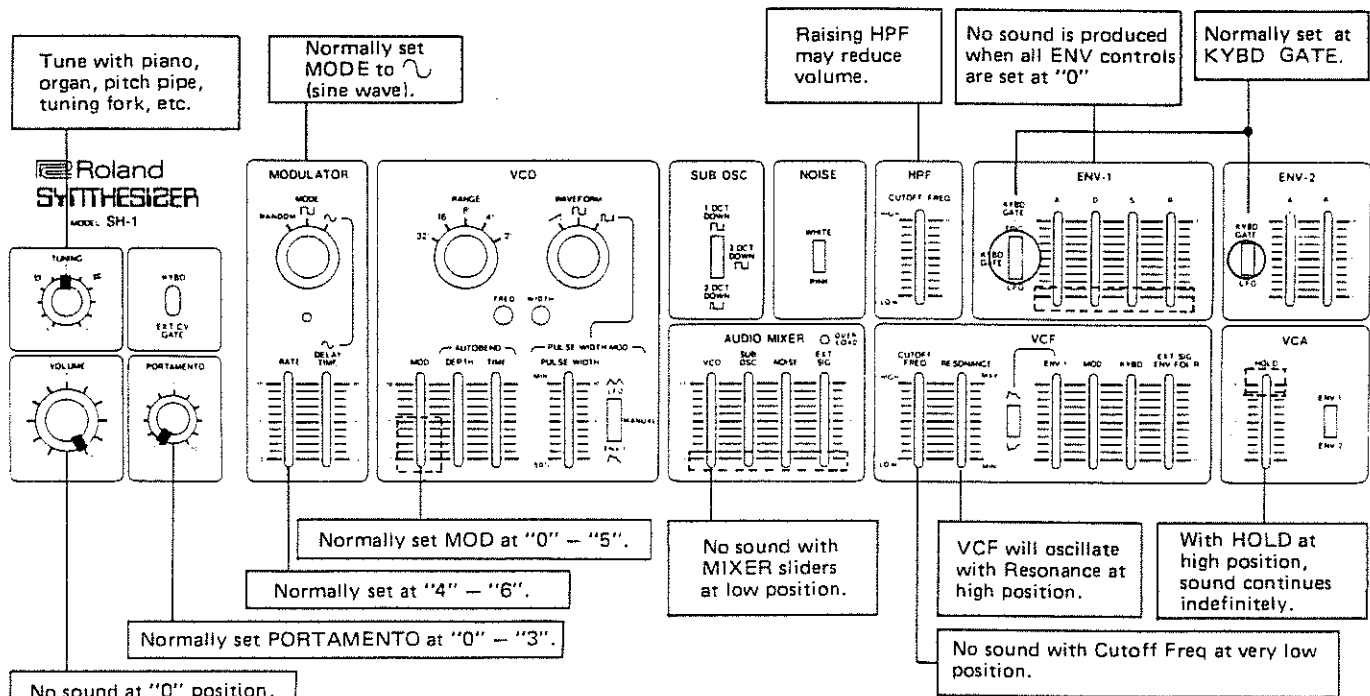

### ■ When no sound is produced at all check the following items.

- (1) Are the POWER switches of the SH-1 and amplifier on?
- (2) Are volume controls of the external amplifier, mixer, etc. raised?
- (3) Are connections correct? (See page 5.)
- (4) Are the cords defective?

# VCF - VOLTAGE CONTROLLED FILTER

## ■ VCF (VOLTAGE CONTROLLED FILTER)

The VCF is a low pass filter whose cutoff frequency (or filtering characteristics) can be controlled by means of a control voltage. The VCF, being a low pass filter, acts in a way opposite to that of the HPF. It passes low frequencies and blocks high frequencies.

The VCF is used to alter tone colors by cutting or boosting harmonics in the signals sent from the VCO or noise generator.

### 1. CUTOFF FREQ CONTROL

This control determines the frequencies which will be removed by the VCF. At its highest position, all sound passes through the VCF without change, thus this may be considered its normal position. If the control is slowly lowered, it will begin to shave off the upper harmonics of the sound passing through the VCF. In its lowest position, the VCF CUTOFF FREQ control will remove all frequencies so that the VCF blocks all sound.

NOTE: If the synthesizer produces no sound, this is one of the first things you should check.

Tone color is determined by the waveform, or the harmonic content, of the sound; the more harmonics there are, the sharper the waveform and the brighter the tone color. The fewer the harmonics there are, the more rounded the waveform will be and the softer the tone color.

The polarity of the envelope control voltage which reaches the VCF is determined by the ENVELOPE POLARITY switch (7). In the normal (↖) position, the VCF cutoff frequency point will rise, following the shape of the envelope, each time the envelope generator is triggered. Since the cutoff point rises, the CUTOFF FREQ control should be kept away from its HIGH position, otherwise the envelope will have no effect.

With the ENVELOPE POLARITY switch in the inverted (↘) position, the cutoff point of the VCF will fall, following the envelope pattern, thus, for this position, the CUTOFF FREQ control should be kept away from its LOW position for the envelope to affect the VCF.

The cutoff frequency is also affected by the KYBD slider. Compensate for this by adjusting the CUTOFF FREQ slider.

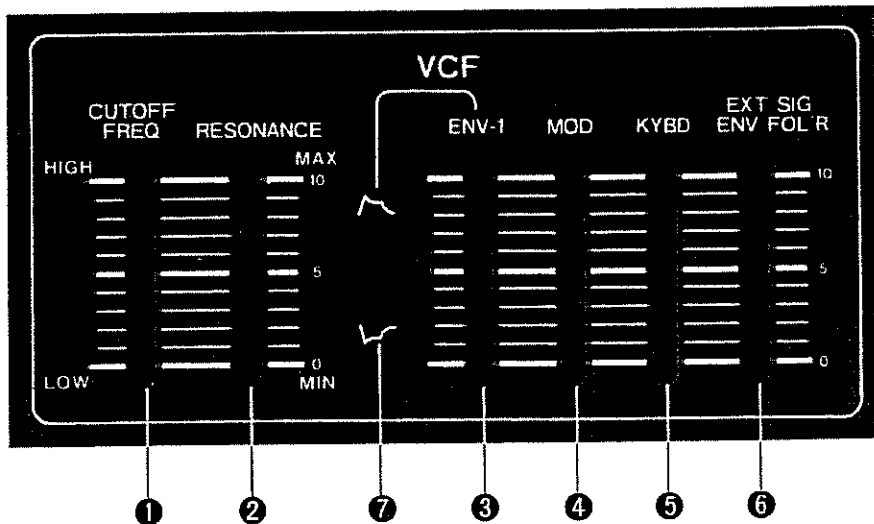

## ■ VCF FREQUENCY RESPONSE

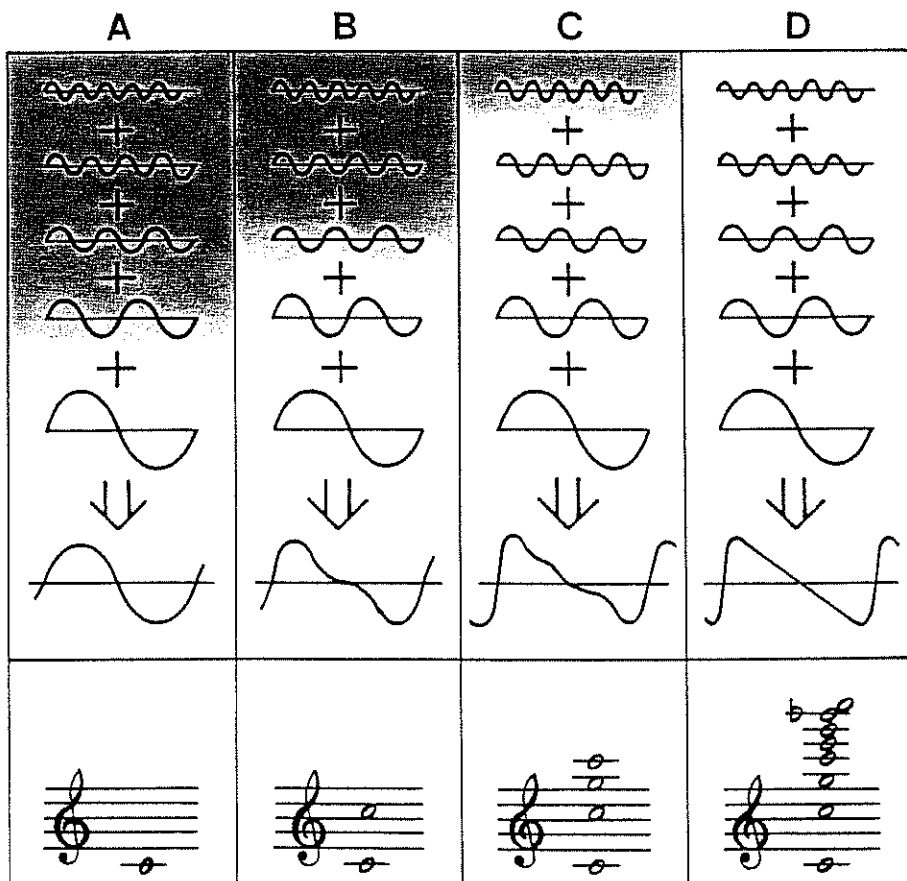
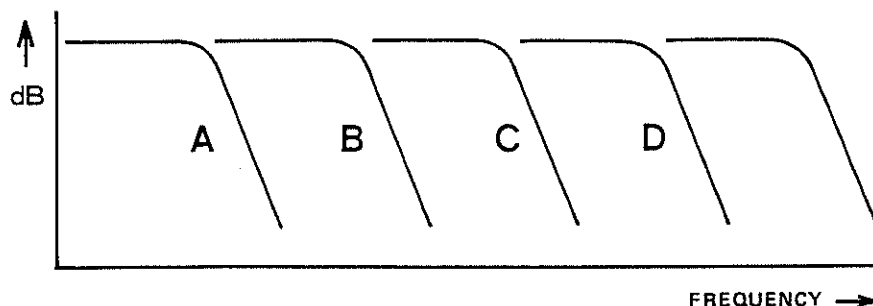



## 2. RESONANCE CONTROL

This control accents the frequencies at the cutoff point of the VCF. At "0", the RESONANCE control has no effect. The effect will become stronger, the higher the control is raised.

With the RESONANCE control at a high position, moving the CUTOFF FREQ slider will produce sounds peculiar to the synthesizer.

At about "8", the frequencies at the cutoff point are accented so strongly that the VCF starts to oscillate by itself, or in other words, it begins generating a sine wave even with no input to the VCF. The frequency of this sine wave will depend on the position of the VCF CUTOFF FREQ control.

When the KYBD slider is raised, the pitch can be controlled with the keyboard to play music. In addition, a variety of effect sounds are also obtained by the oscillating VCF.

When the resonance control is set at a high position, total volume may fall. The volume should be compensated for with the volume control.

## 3. ENV-1 CONTROL



With this control raised, the cutoff point of the VCF will change during the production of each note, following the pattern dictated by the setting of ENVELOPE GENERATOR 1. This type of VCF modulation is very often used with brass sounds.

For example, with the ENV-1 controls at around A=0, D=5, S=0, R=5, the  type envelope controls the VCF. The VCO waveform, a square wave in this case, is modified from A to E as shown at the right each time a key is depressed.

At the instant a key is depressed, the cutoff frequency is high and the original VCO wave passes unchanged.

As time passes, the envelope voltage falls and the cutoff frequency lowers, changing the waveform from B to D.

If the cutoff frequency slider is lowered below a certain level, signals are blocked as shown at E.

With the ENV-1 polarity in the inverted position () the VCO waveform changes in the opposite way. Normally, the Polarity switch is set in the normal position (). The inverted () envelope is used for producing special effects.

## ■ FUNCTION OF RESONANCE CONTROL

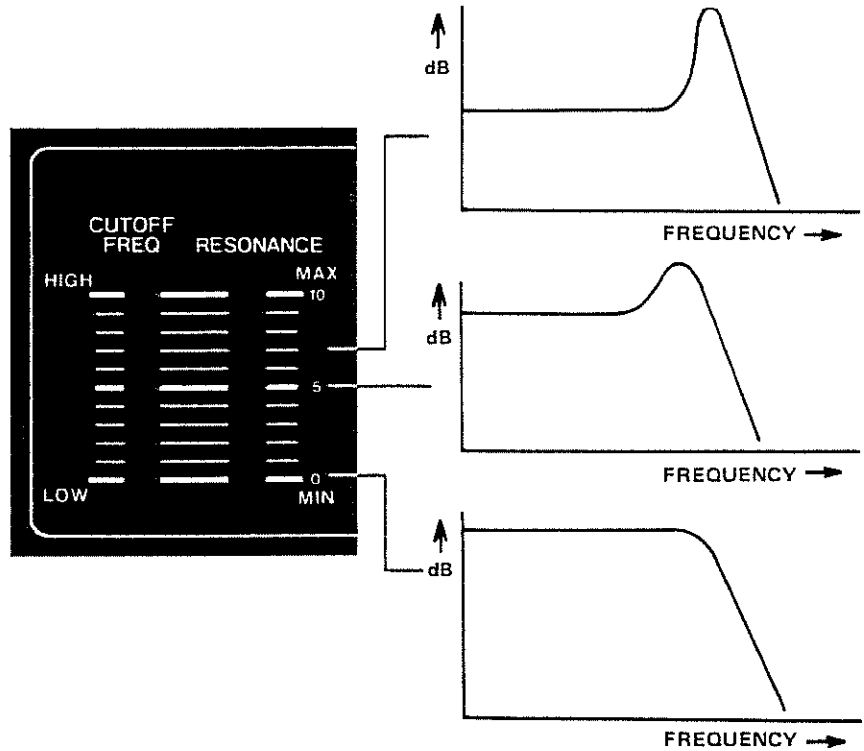

## ■ CONTROL OF VCF BY ENVELOPE ()

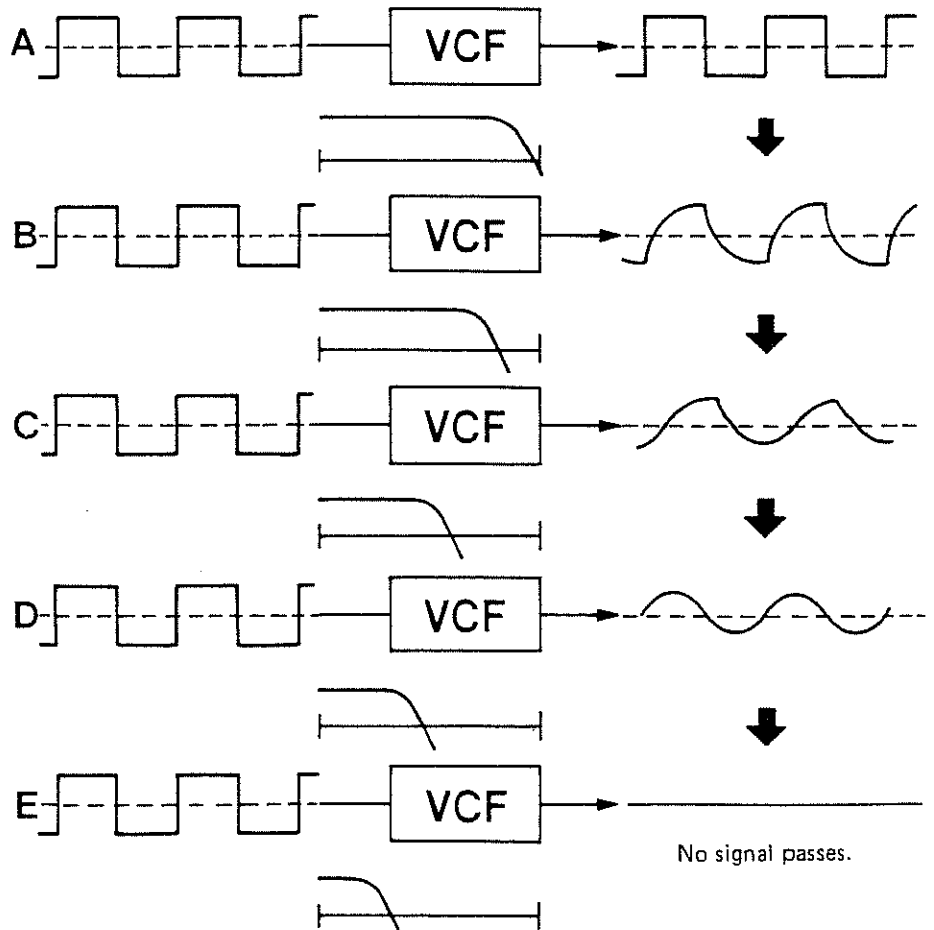

# VCF - VOLTAGE CONTROLLED FILTER

## 4. MOD (Modulator)

Controlling the VCF with the Modulator MODE switch at the (∞) position produces effects like continuous wah pedal movement. With the MOD slider at the maximum, growl or flutter effects are produced. With the RESONANCE slider at the lower position, tremolo effects are produced, which is a slight varying of the loudness.

With the Modulator MODE switch at RANDOM, the VCF response varies stepwise to produce very interesting tone color changes which are useful for processing noise or external signals.

## 5. KYBD CONTROL

This control allows control of the VCF cutoff point by means of the keyboard control voltage. The tone color of many instruments will change with pitch; this effect can be produced by means of keyboard control voltage control of the VCF cutoff point. When the slider is set at maximum, the VCF cutoff frequency will change at the rate of 1 volt/1 octave, and the VCF CUTOFF FREQ control will have to be set a little lower than it would be without keyboard control.

## 6. EXT SIG ENV FOL'R (ENVELOPE FOLLOWER) CONTROL

This control will allow the VCF cutoff point to follow the level of an external audio signal. To get effective wah effects, keep the external signal level so that the overload indicator goes on at the peak volume.

The best wah effects are obtained with instruments whose sounds decay slowly, such as guitars and pianos. It is also interesting when used with wind instruments and the human voice. See pages 47 and 48.

### ■ CONTROL VOLTAGES ON VCF

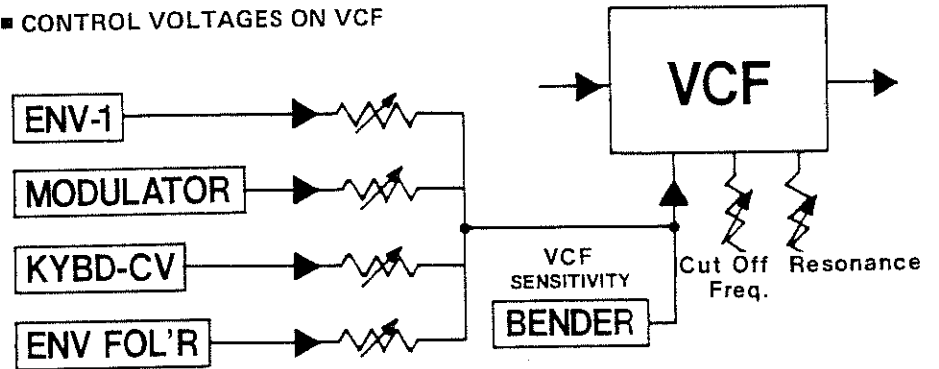

### ■ CONTROL OF VCF BY KYBD-CV

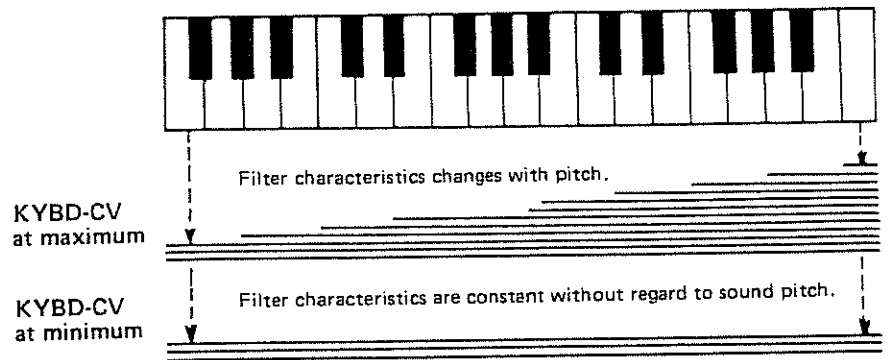

### ■ CONTROL OF VCF BY ENVELOPE FOLLOWER

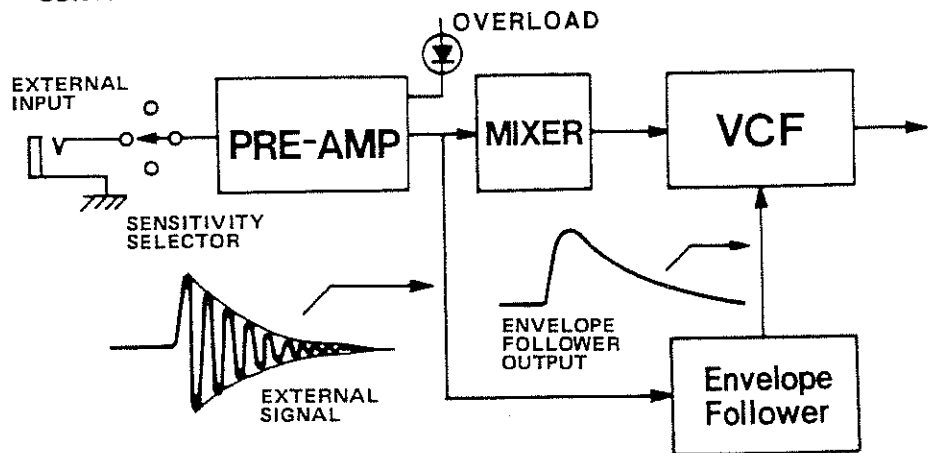

### ■ EXAMPLE OF SETTING TO USE ENVELOPE FOLLOWER

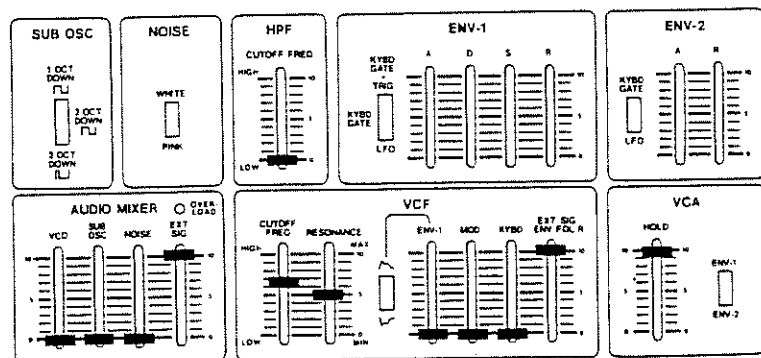

# VCA - VOLTAGE CONTROLLED AMPLIFIER

## ■ VCA (VOLTAGE CONTROLLED AMPLIFIER)

The VCA is an amplifier whose gain is controlled by a control voltage. In other words, the varying control voltage acts much like a volume control to any sound passing through the VCA. If the output of the envelope generator is used to control the VCA, then the sound passing through the VCA will take on a loudness pattern corresponding to the shape of the envelope voltage.

### 1. ENVELOPE SWITCH (ENV-1/ENV-2)

This switch decides which of the two envelope generators will control the VCA. At ENV-1, the envelope used for control of the VCF is also used for the control of the VCA.

Normally this is set at ENV-1, which has A (attack), D (decay), S (sustain), and R (release) controls. The ENV-2 has A (attack) and R (release) controls only and is convenient for synthesizing continuous sounds like the violin and organ.

When controlling the VCA by an envelope separately from the VCF (for brass instruments, for example), use ENV-2.

### 2. HOLD CONTROL

When there is no envelope, the VCA is "closed" and will not pass sounds. Raising the HOLD control will "open" the VCA to let sounds through. It is most often used when it is desirable to control the sound envelope entirely by means of the VCF, or when tuning the synthesizer, or when processing external sound sources.

When controlling the VCA with an envelope, set the HOLD slider at "0". If the HOLD slider is raised, the volume of sound cannot be controlled by the envelope as shown at the right. With the HOLD slider at "10", the VCA is completely "open" and sound is produced at a constant volume.

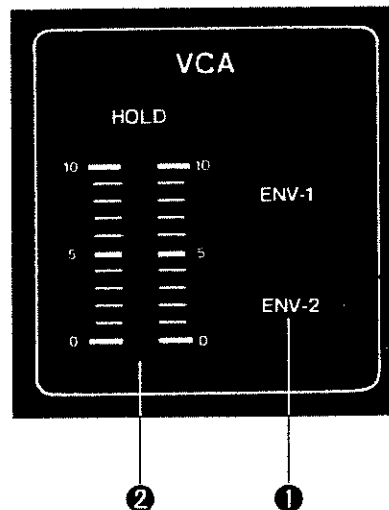

## ■ FUNCTION OF VCA

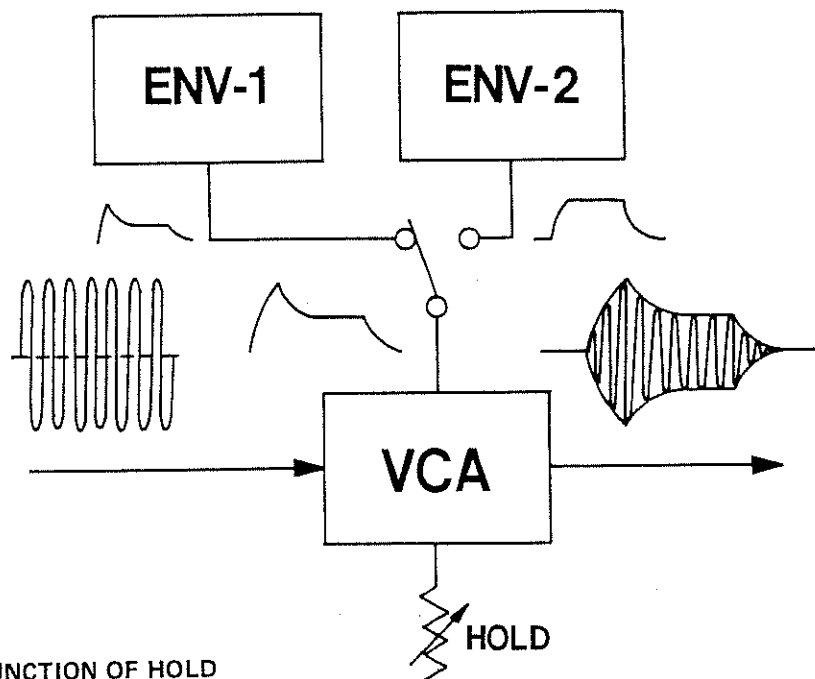

## ■ FUNCTION OF HOLD

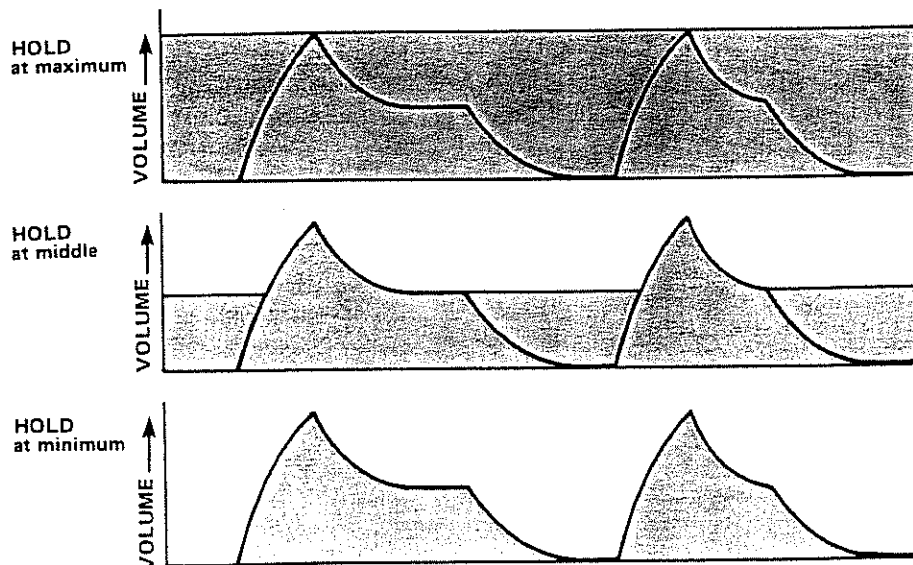

# ENVELOPE GENERATOR

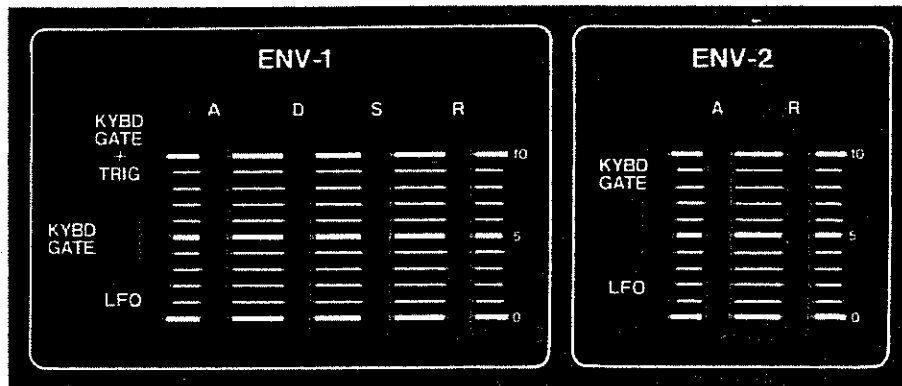

## ■ ENVELOPE GENERATOR

Depressing a key on the keyboard triggers the envelope generator into action. The envelope generator generates a control voltage which varies with time according to the control settings. This control voltage is used to control the VCF cutoff frequency point so as to vary the tone color during the production of a note, and/or it is used to control the VCA to give the output sound its loudness contour. The drawing on the right shows the four parts of an envelope.

The SH-1 incorporates two envelope generators. The VCF is controlled by the ENV-1, while the VCA can be controlled by either the ENV-1 or ENV-2.

ENV-1 has four controls: A (attack), D (decay), S (sustain), and R (release). ENV-2 has two controls: A (attack) and R (release) with a sustain level set permanently at maximum.

## ■ CONTROL BY ENVELOPE

When controlling the VCF and VCA with envelopes, four combinations are possible:

### 1. Controlling VCA with ENV-2

Only the VCA is controlled by the AR sliders of ENV-2 to synthesize the sound of strings, etc.

### 2. Controlling VCA with ENV-1

Only the VCA is controlled by ENV-1 to synthesize piano-like sounds.

### 3. Controlling both VCF and VCA with ENV-1

Both the VCF and VCA are controlled with ENV-1.

This mode is most frequently used.

### 4. Controlling the VCF with ENV-1 and the VCA with ENV-2

The VCF and VCA are controlled by different envelopes to synthesize brass sounds.

## ■ GATE TRIGGER SELECTOR SWITCH

This switch selects the pulse which will activate the envelope generator.

## ■ ENV-1 OUTPUT (ADSR)

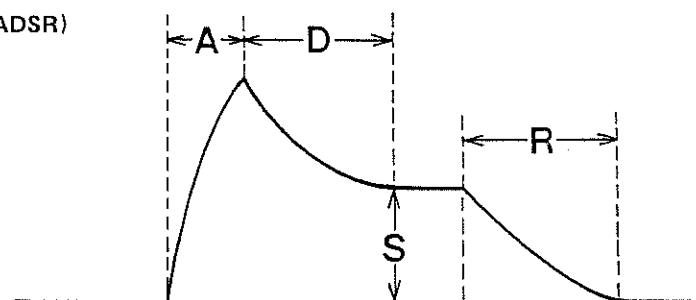

## ■ KYBD GATE

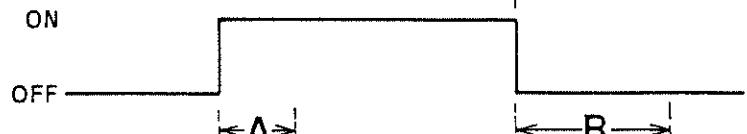

## ■ ENV-2 OUTPUT (AR)

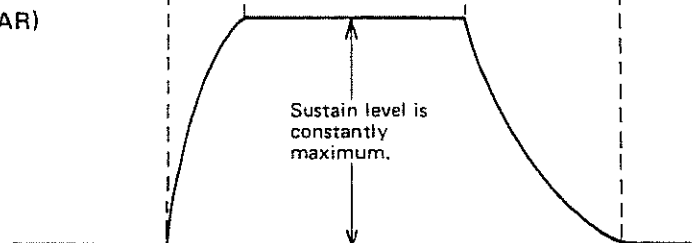

**A (ATTACK TIME) CONTROL** This slider controls the amount of time which is required for the voltage to reach its maximum level after a key is depressed. This is called attack time.

**D (DECAY TIME) CONTROL** This slider controls the amount of time required for the voltage to fall to the level set by the SUSTAIN control. This time is called decay time.

**S (SUSTAIN LEVEL) CONTROL** This slider determines the level to which the voltage will fall at the end of decay time. Once this level is reached (at the end of decay time) it will be held until the key is released. Note that if the SUSTAIN control is set at maximum, there will be no decay time since the voltage level cannot fall to maximum. With the SUSTAIN control at maximum, then, the DECAY control has no effect. Note that ATTACK, DECAY, and RELEASE control time elements and SUSTAIN controls level.

**R (RELEASE TIME) CONTROL** This slider determines the amount of time required for the voltage to fall to minimum level after the release of the key.

This switch is usually set at GATE + TRIG or GATE for triggering the envelope generator each time a key is depressed.

The gate portion of the keyboard output actually consists of two simultaneously generated pulses. The gate pulse is merely a constant voltage which appears any time one or more keys are in the depressed position. In other words, it is like the output of a light switch. Depressing one or more keys turns the voltage on; when all keys have been released, the voltage goes off.

The trigger pulse is a short pulse which is generated when a new key is depressed. When two or more keys are pressed, a trigger pulse will be produced each time the highest key in the group is depressed or released.

The GATE + TRIG position of this switch might be considered its normal position. This position will trigger the envelope generator for each note in a passage played legato as shown at (A). It is also useful for playing fast trills very easily. This is accomplished by holding down the lower note in the trill while repeatedly tapping on the key for the upper note of the trill. The GATE position of this switch is useful in legato passages where it is desirable to produce only one envelope for the complete phrase.

In the LFO position, depressing a key will cause the envelope generator to be triggered by the LFO. This is useful for producing rapidly repeating notes such as those sometimes used in mandolin playing. In addition, this position synchronizes the LFO output to the keyboard so that the pattern of repeated notes will always start the instant a key is depressed.

### FUNCTION OF GATE AND TRIGGER

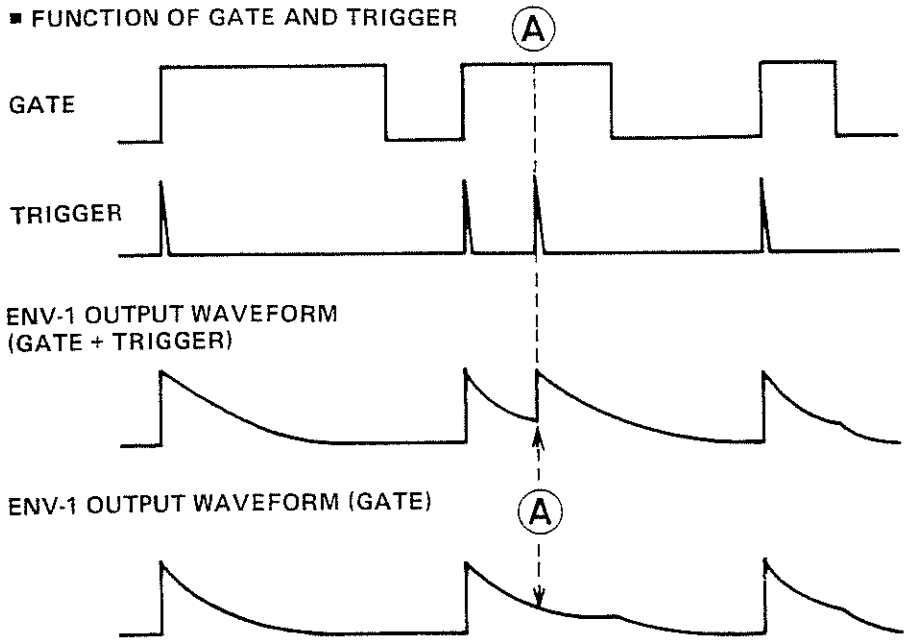

### ENVELOPE GENERATOR CONTROLLED BY LFO

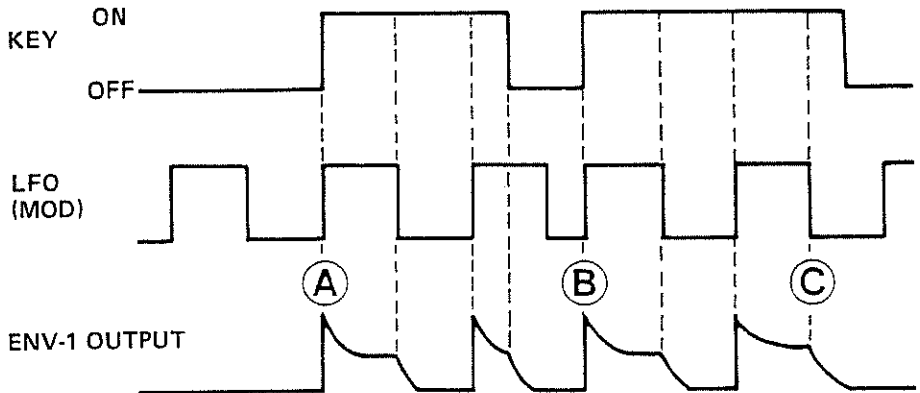

### ENVELOPES FOR VARIOUS INSTRUMENTS

	FLUTE	VIOLIN	TRUMPET	HARPSICHORD	XYLOPHONE
ENVELOPE WAVEFORM					
ADSR SETTING	2 0 10 2	3 0 10 2	2 4 5 2	0 4 0 4	0 2 0 2
CONTROLLED FUNCTION	VCF/VCA	VCA	VCF/(VCA)	VCA	VCF/VCA

# MODULATOR (LFO)

## ■ MODULATOR

The Modulator includes an LFO and an S/H as shown below.

The LFO is an oscillator which generates waveforms of a low frequency. The range is from about 0.2Hz to about 25Hz. The output of the LFO can be used for modulating the VCO, or VCF, and for triggering the envelope generators.

The S/H (Sample and Hold) produces random signals by sampling the output from the noise generator at a rate determined by the LFO (See opposite page).

### 1. MODE SWITCH

This switch determines which waveform will be used for VCO and VCF modulation. The  is the most commonly used waveform. Controlling the VCO, it produces vibrato effects, or pitches which sweep up and down. Controlling the VCF, it produces growl effects (with faster LFO rates) or tone color vibrato, which occurs in some instruments in conjunction with pitch vibrato.

The other positions are more often used for special effects. For example, using the square wave to modulate the VCO pitch will produce trills.

### 2. RATE CONTROL

The RATE slider controls the frequency of the modulator output. Raising the control increases the frequency. The frequency can be visually checked by means of the LED. For vibrato-like effects, this control is normally set at about "5".

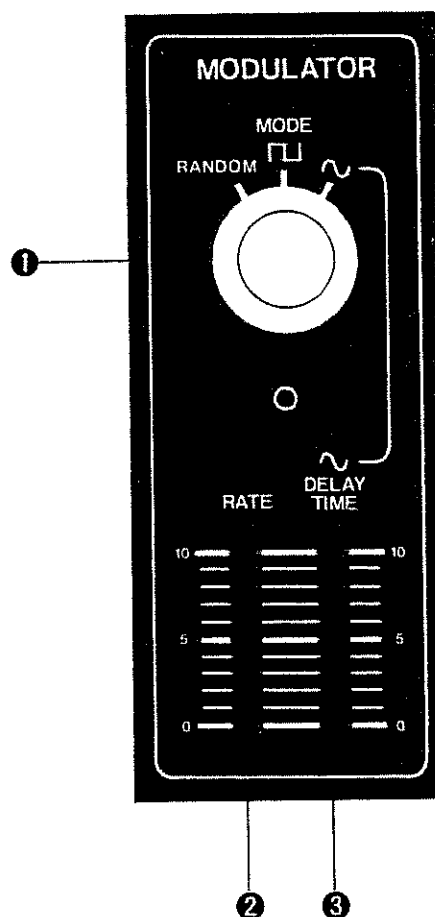

## ■ CONSTRUCTION AND FUNCTION OF MODULATOR

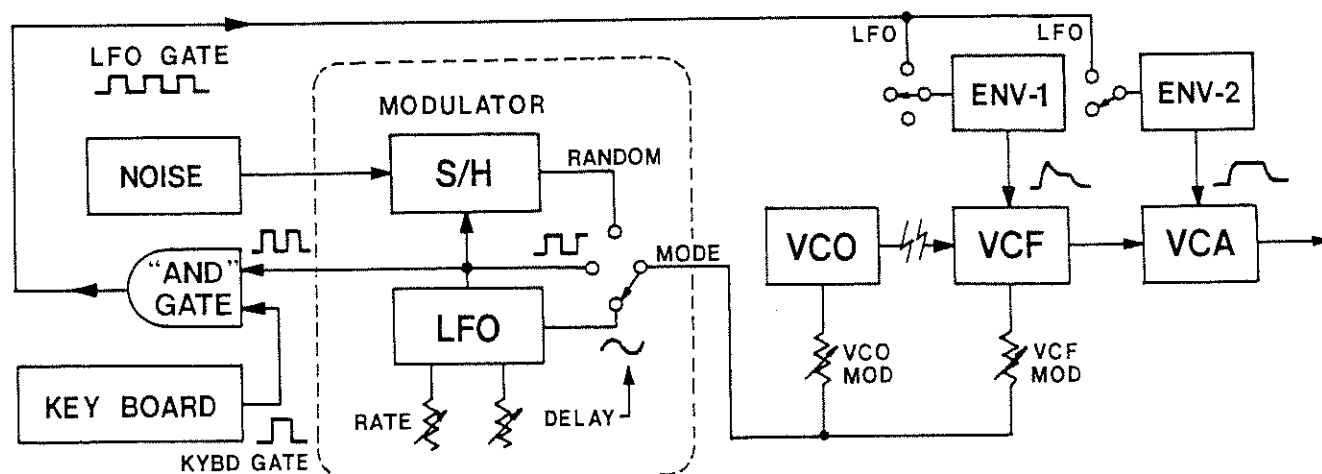

### 3. DELAY TIME CONTROL

When this control is raised, pressing a key on the keyboard will produce a delayed entry of the sine wave. This is especially effective for delayed vibrato effects, such as in the musical example shown at the right. The delayed sine wave is also useful for delayed growl or wah wah, and for delayed tremolo. If delayed entry of the sine wave is not desired, then this control must be set at "0".

### ■ GATE TRIGGER SWITCH

When the GATE TRIG switch of the envelope generator is set at the LFO position, the frequency of the LFO is locked to the keyboard gate pulse. What this means is that when a keyboard gate pulse appears, it triggers the LFO to begin its wave generating process from the beginning, or in other words from the highest level contained in the waveform. With some uses of the LFO, this is a desirable feature. The drawing at the right shows what happens to the LFO waveforms when a gate pulse occurs.

### ■ SAMPLE/HOLD

The S/H (Sample and Hold) produces random voltage sequences by sampling input waveforms. Each sample represents the voltage level at the instant the sample was taken. The HOLD portion of the circuit holds this voltage level until the next sample is taken. The result of this is a control voltage output which changes stepwise in random patterns. When used to control the VCO, this produces notes with random pitch patterns when the Envelope Generator GATE TRIG switch is set at LFO and a key on the keyboard is pressed, as shown below.

### ■ EXAMPLE OF DELAYED VIBRATO



### ■ KEY TRIGGER ACTING ON PHASE OF EACH WAVE

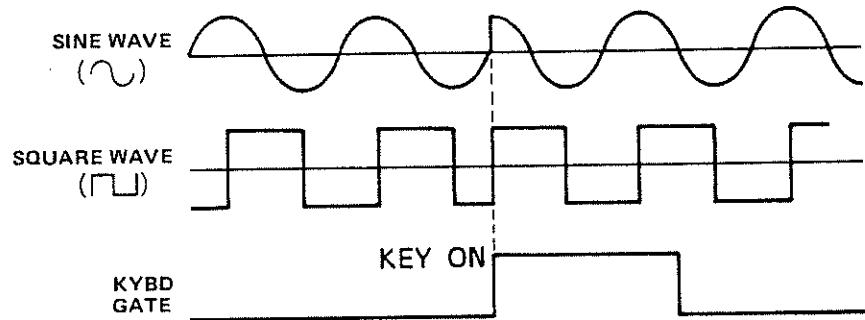

### ■ FUNCTION OF SAMPLE & HOLD

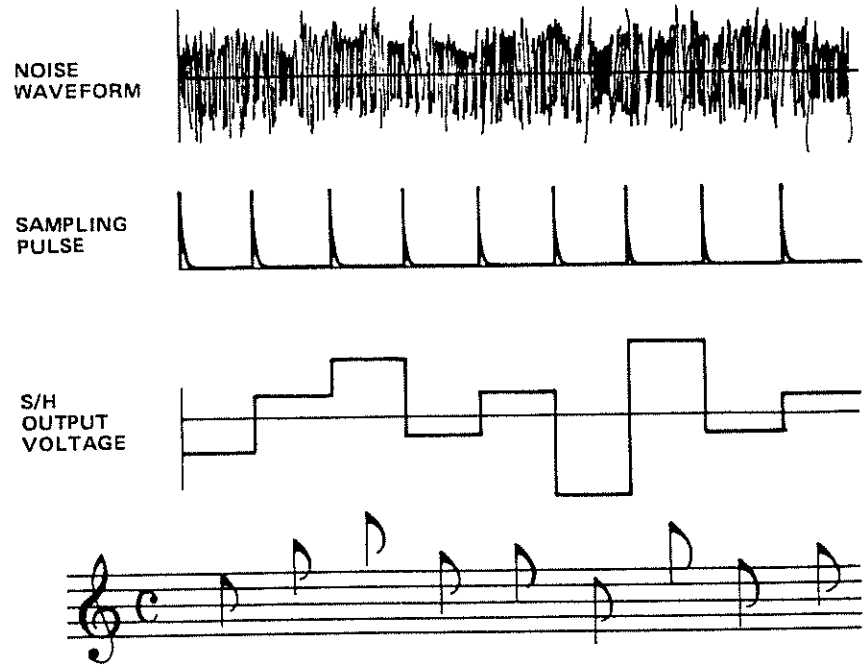

### ■ EXAMPLE OF SETTING FOR RANDOM NOTE

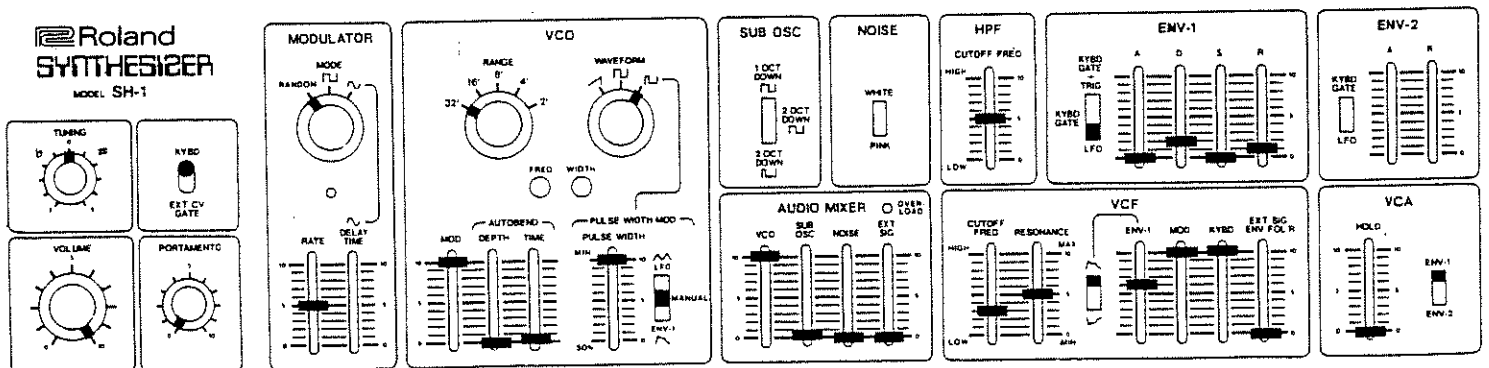

# SYNTHESIZING SOUNDS 1. WAVEFORM AND RANGE

■ Basic Setting (depressing key produces 8'  $\nearrow$  wave)

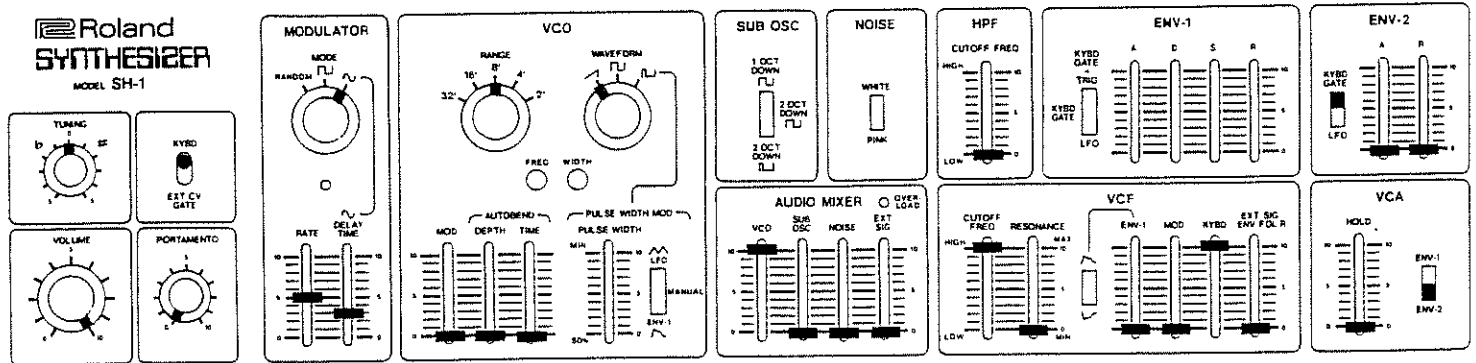

In order to understand synthesis it is usually best to begin by imitating known sounds. Using a guitar amplifier, stereo amplifier, or headphones, read and try the following.

## 1. The Basic Setting

First set the synthesizer as shown in the drawing above. Pressing a key produces the sound of the 8'  $\nearrow$  waveform. Try this sound with the RANGE switch at 32', 16', 4', and 2' also.

## 2. Differences in Waveforms

Since the VCF CUTOFF FREQ control is at HIGH, the VCO waveforms pass through the synthesizer without change. Try the other waveforms.

Changing the WAVEFORM switch to  $\square$  as shown in (1) produces the square wave. Note the difference between this tone color and that of the sawtooth wave.

The WAVEFORM switch setting in (2) produces the pulse wave. Try moving the PULSE WIDTH slider slowly up and down and note the differences in tone color. (3) shows how to obtain LFO modulation of the pulse width. This produces a very electronic type sound. Try different positions of the PULSE WIDTH slider and the MODULATOR section RATE slider. (4) shows how to obtain pulse width modulation by means of ENV-1. Try ENV-1 settings of: A=0, D=5, S=0, and R=5 for an interesting effect.

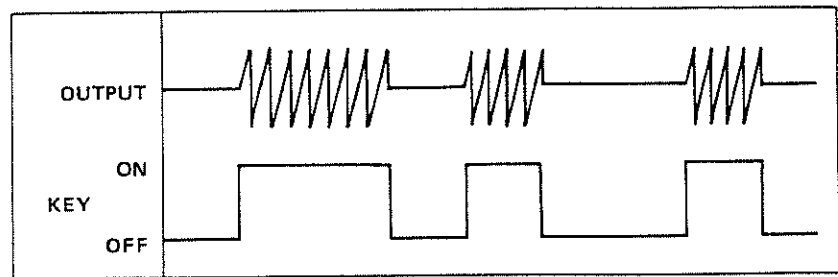

1  $\square$  SQUARE WAVE

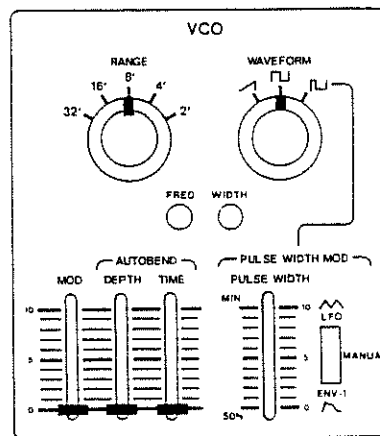

2  $\square$  PULSE WAVE

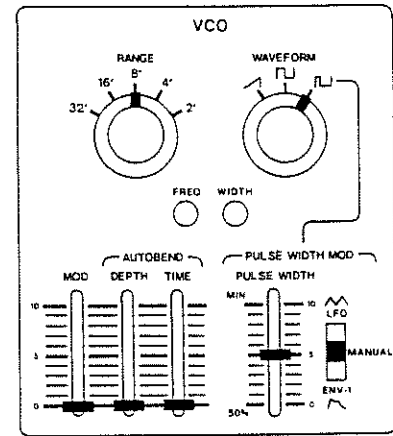

3 LFO MODULATION OF PULSE WAVE

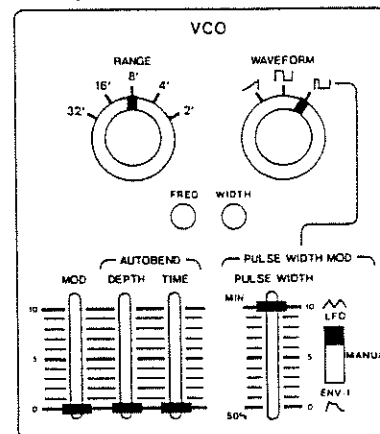

4 ENVELOPE MODULATION OF PULSE WAVE

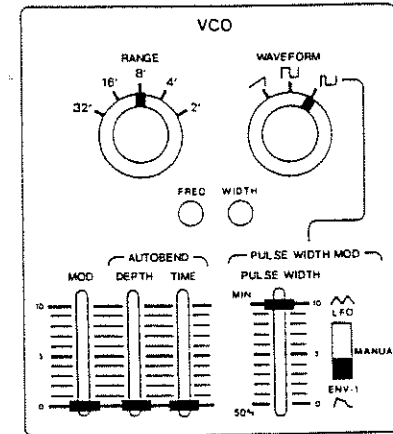



# SYNTHESIZING SOUNDS 2. ENVELOPES

## 1. Envelope Control of the VCA

It is the nature of the VCO to produce its waveforms continuously. Using the Basic Setting (opposite page), try moving the VCA HOLD control up; the sound will be continuous whether a key is pressed or not. With the normal Basic Setting, the VCA is controlled by means of an envelope generator to produce sound only when a key is pressed.

In the Basic Setting, the ENV-2 "A" and "R" controls are at "0", thus the sound is like an electronic organ because it starts and stops instantly. If the ENV-2 controls are set as shown in (1) at the right, the sound will take on the shape of a violin sound. The tone quality will become even more violin-like if you use the sawtooth waveform with the RANGE switch set at 4' or 8'. Check the sound with other settings of the RANGE switch, too.

## 2. Controlling the VCA with ENV-1

The sustain level of ENV-2 is permanently set at maximum; only the attack time ("A") and release time ("R") are adjustable. To produce envelopes such as shown in (2) and (3), use ENV-1 to control the VCA. To do this, set the VCA envelope select switch at ENV-1.

(2) shows an example of a piano-like envelope setting. Raise the HPF slider and use the Pulse wave output of the VCO with ENV-1 control of pulse width modulation for a harpsichord-like sound. Try this envelope setting with different waveforms and RANGE settings.

(3) shows a very percussive envelope for pizzicato-like sounds. Try different widths of the pulse wave set at 4' or 8'. Also, try the sawtooth wave set at 32'.

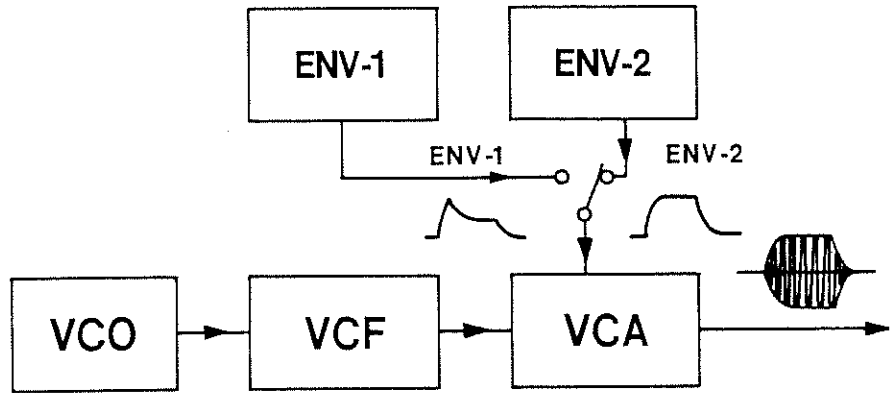

(1) STRINGS ENVELOPE

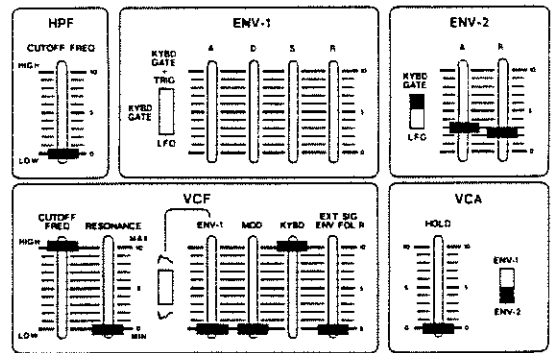
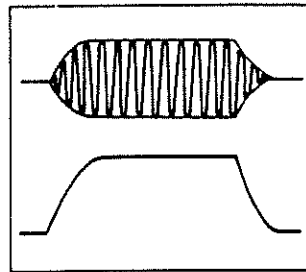

(2) PIANO ENVELOPE

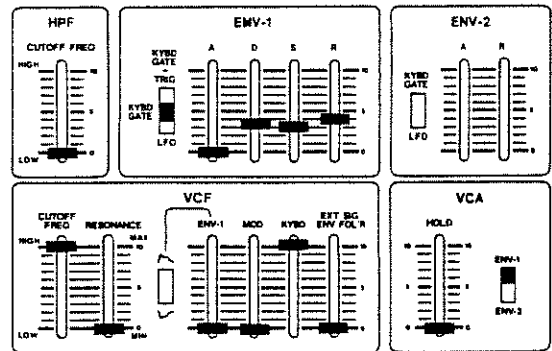
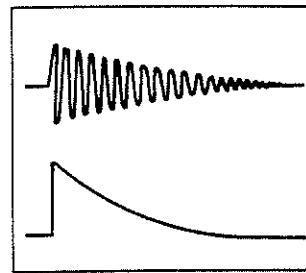

(3) PIZZICATO ENVELOPE

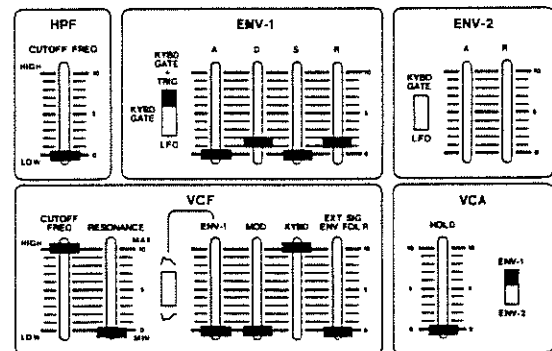
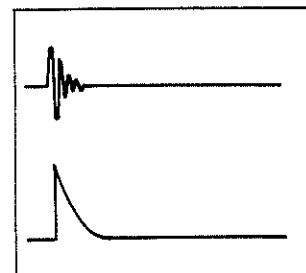

# SYNTHESIZING SOUNDS 3. CONTROLLING TONE COLOR WITH THE VCF

## Controlling Tone Color with the VCF

All the settings on the previous page were with the VCF CUTOFF FREQ set at HIGH so that the VCF had no effect on the sound. Set this way the VCF becomes a fixed filter. In the drawing below, the CUTOFF FREQ and RESONANCE controls are set to alter the tone color of the waveforms from the VCO. The KYBD slider is raised so that the filter will follow the pitches played on the keyboard. The loudness contour of the sound is produced by ENV-1 control of the VCA.

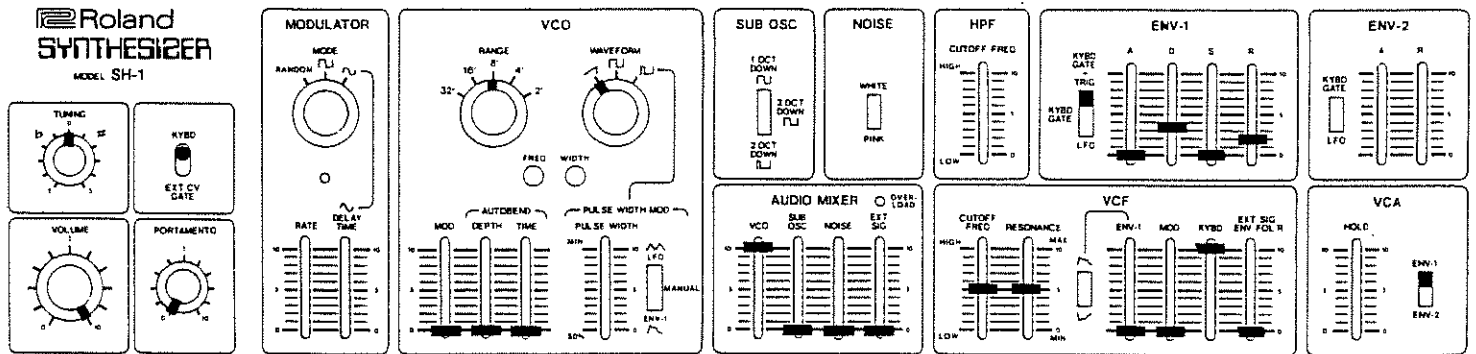
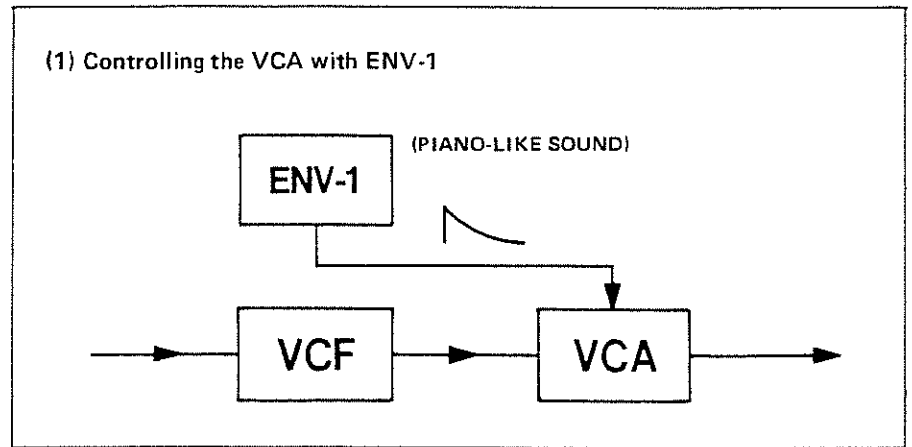

Since the KYBD slider is raised causing the VCF to follow the pitches played, the tone color will be the same for all notes played, thus, using ENV-2 to control the VCA produces organ-like sounds.

Moving the VCF CUTOFF FREQ or the VCO PULSE WIDTH controls will change the tone color. Try raising the AUDIO MIXER SUB OSC slider to produce a bigger sound. Also try the BENDER for a choking effect.

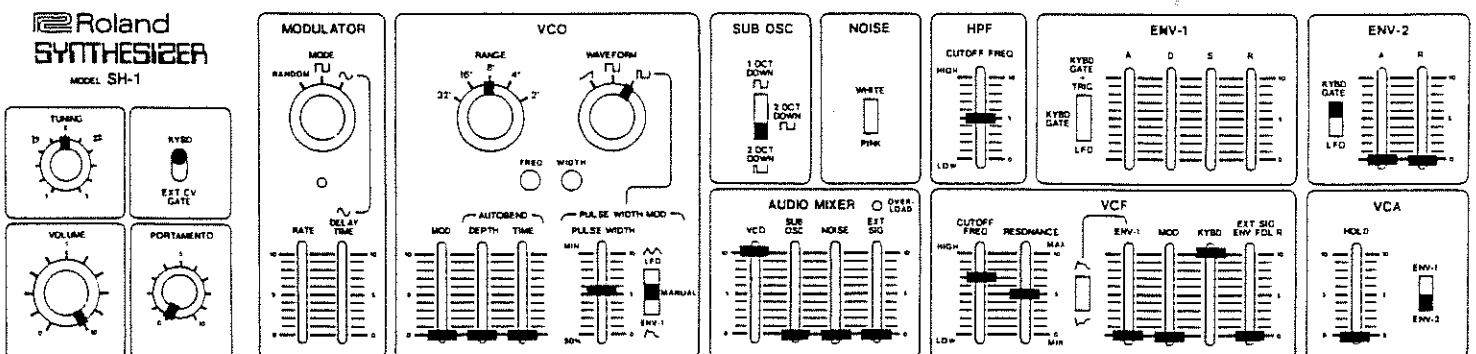
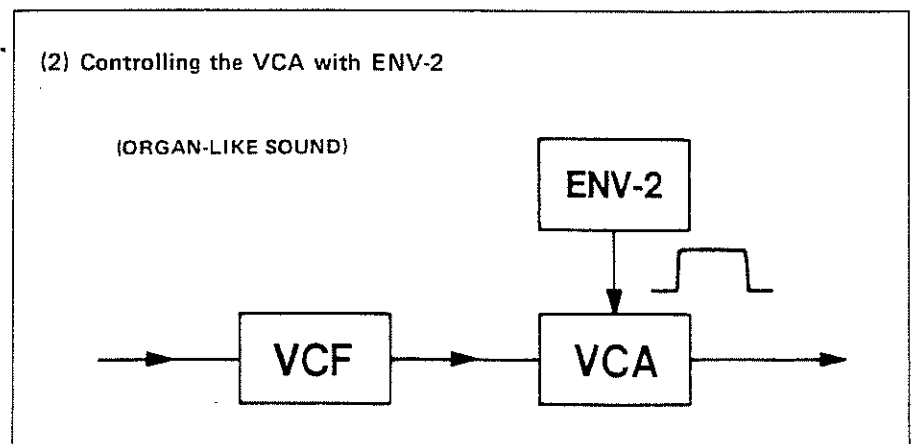

# SYNTHESIZING SOUNDS 4. ENVELOPE CONTROL OF THE VCF

## Controlling the VCF with the Envelope

In the drawing at the right, both the VCF and VCA are controlled by the same envelope. This type of setting is the most common. The drawing below shows an example of a string bass sound. With the VCF ENV-1 control at "10", the cutoff point of the VCF is controlled by ENV-1. This can be heard clearly by raising the VCA HOLD control.

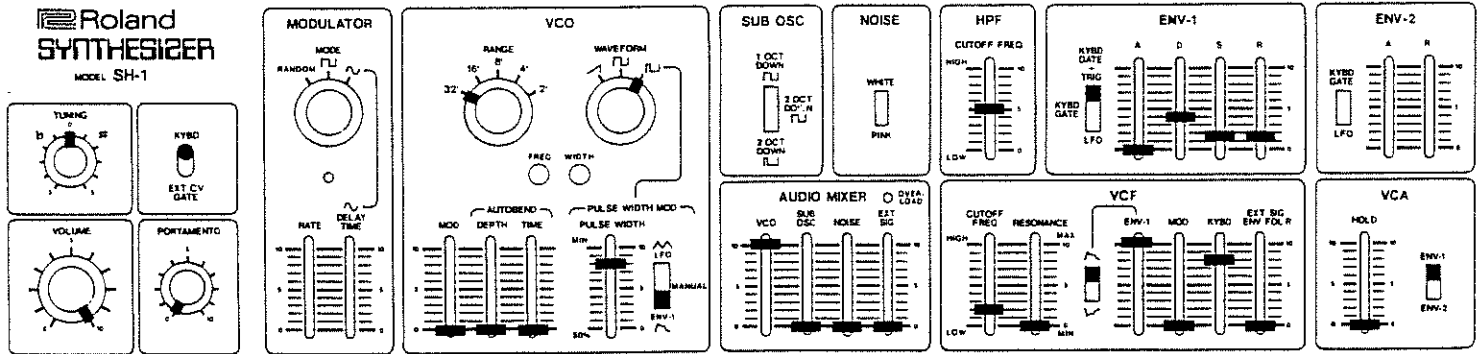
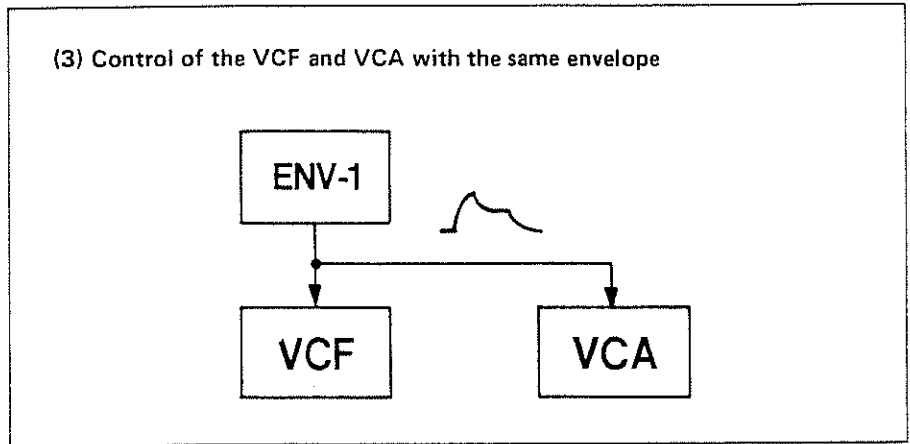

This example shows control of the VCF and VCA by separate envelopes such as might be used for brass instrument sounds. The example below shows a trumpet sound. ENV-1 controls the VCF to change the tone color during the production of each note, while ENV-2 controls the VCA in what is almost only an on/off function.

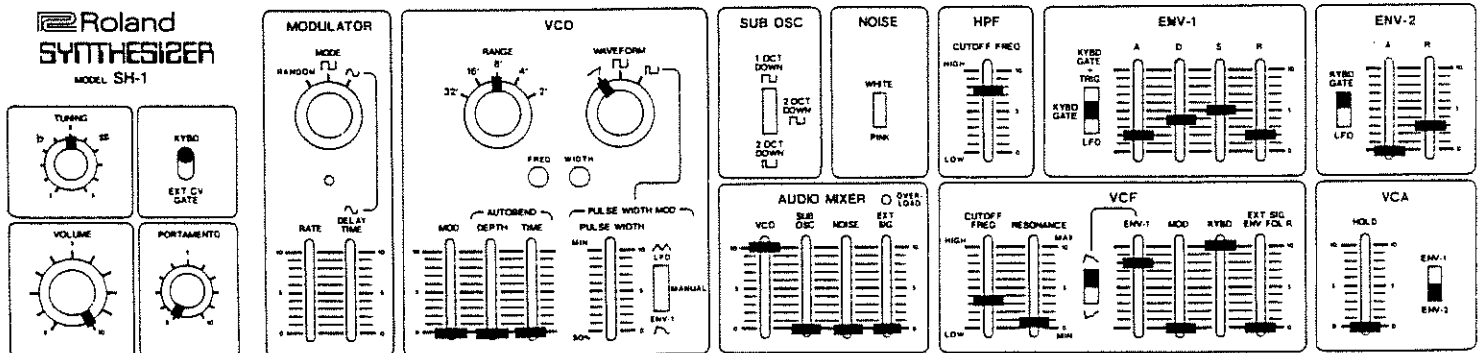
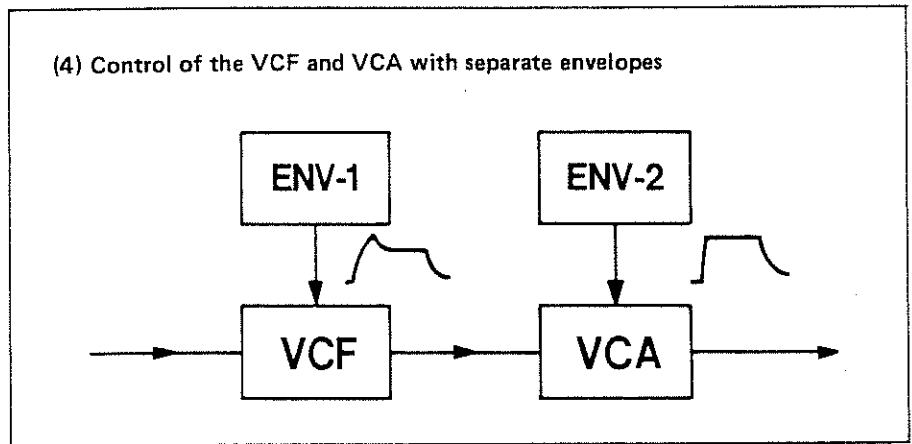

# SYNTHESIZING SOUNDS 5. ENVELOPE CONTROL OF THE VCF

## Electronic Sounds

### 1. Wah-Wah Sounds

Electronic sounds particularly associated with the synthesizer are produced by means of the VCF RESONANCE control. Each time a key is depressed, a sound like the word "wow" is produced. This is done by means of envelope control of the VCF with the RESONANCE control raised. Set the VCO RANGE and the VCF CUTOFF FREQ to produce the desired effects. Also, try changing the shape of the envelope to alter the speed and shape of the tone color change.

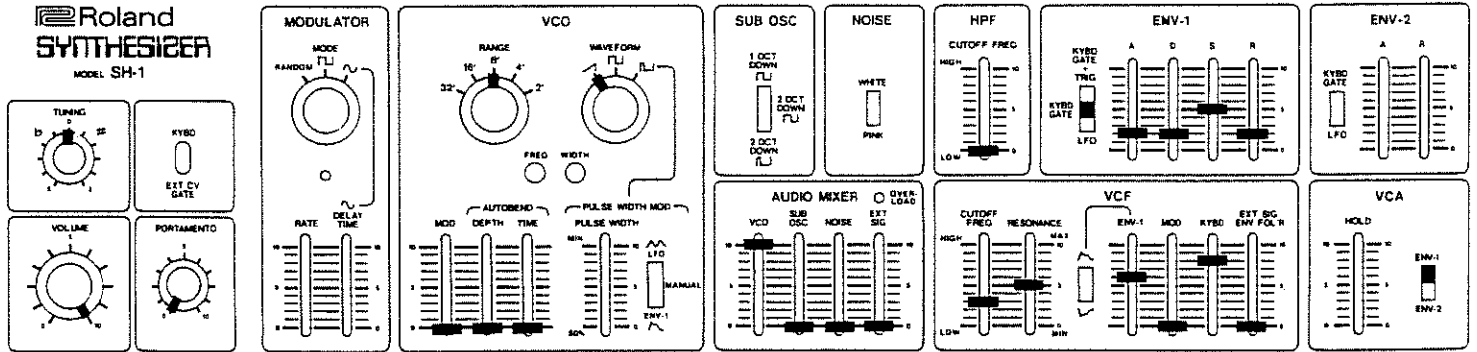
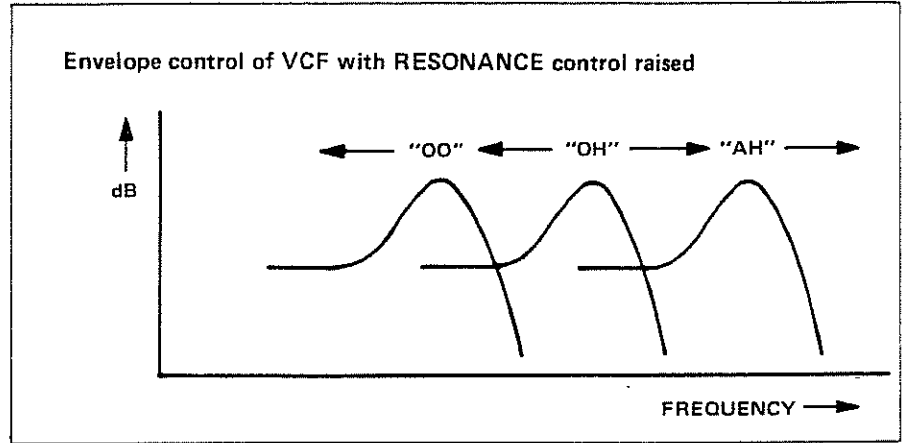

### 2. The Human Voice

The VCF envelope switch allows the VCF to be controlled by means of a normal envelope (∩) or inverted envelope (∪), as desired.

The settings below produce a sound very near that of the human voice. Since a small change in the VCF CUTOFF FREQ control can cause a rather large change in the sound quality, you may have to readjust this setting to get a sound you like. The AUTOBEND control of the VCO and the delay vibrato both help the effect and should be adjusted to suit your tastes.

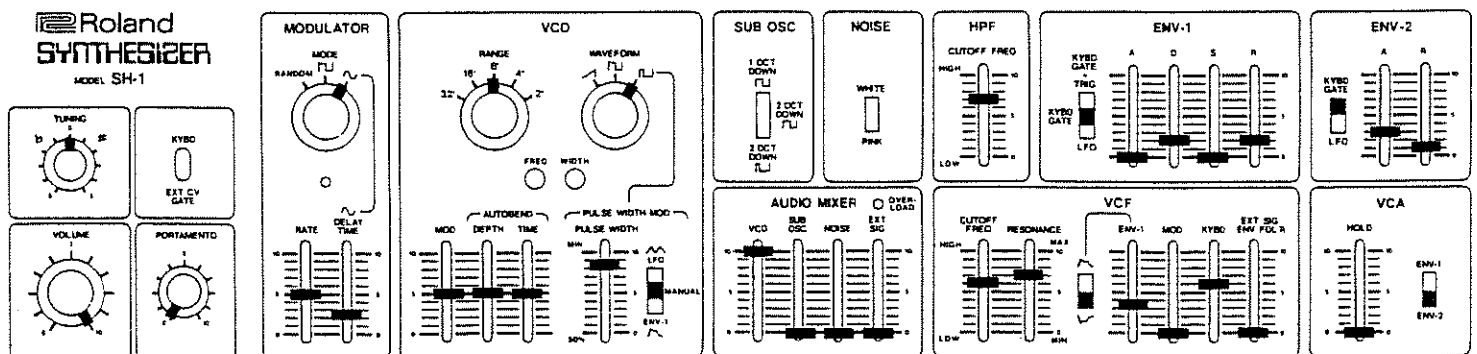
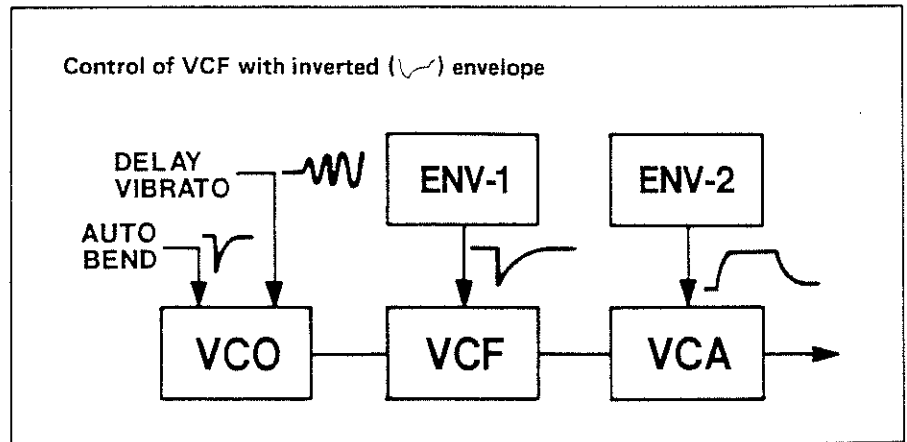

# SYNTHESIZING SOUNDS 6. THE OSCILLATING VCF

## Examples of Using the Oscillating VCF

### 1. The Oscillating VCF

Raising the VCF RESONANCE control to MAX causes the VCF to oscillate by itself. The frequency of these oscillations will depend on the VCF CUTOFF FREQ. The VCF is calibrated for 1 volt/octave which means that if the VCF KYBD control is raised to "10", melodies can be played using the keyboard.

The oscillating VCF produces a perfect sine wave. With the settings shown on the right, melodies can be played on the keyboard, and the VCF CUTOFF FREQ control acts as a tuning control. Also, try moving the ENV-2 "A" control a little.

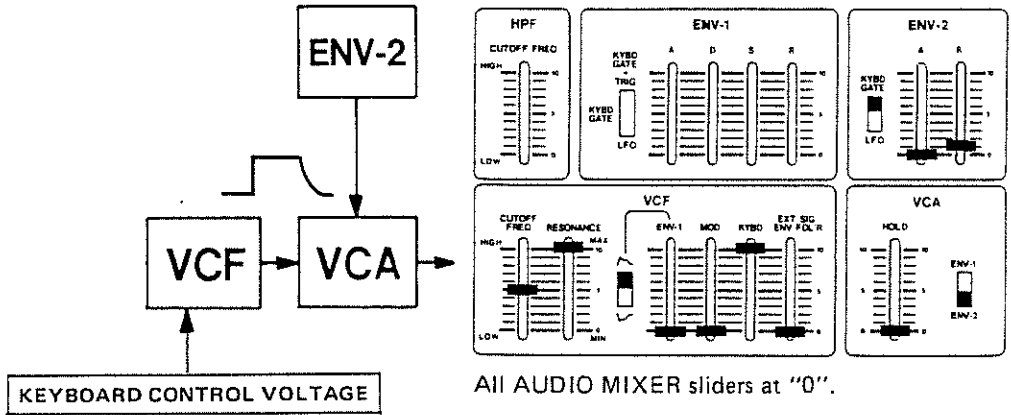

### 2. Whistling

The sound of whistling is very near the sound of a sine wave; adding a little noise using the AUDIO MIXER produces the effect of air passing between the lips. To add a vibrato effect, the VCF MOD control is raised a little. Set the MODULATOR section at  $\sim$  with a RATE of about "4.5" and a DELAY TIME of about "3". The use of ENV-1 to control the VCF produces the effect of an autobend.

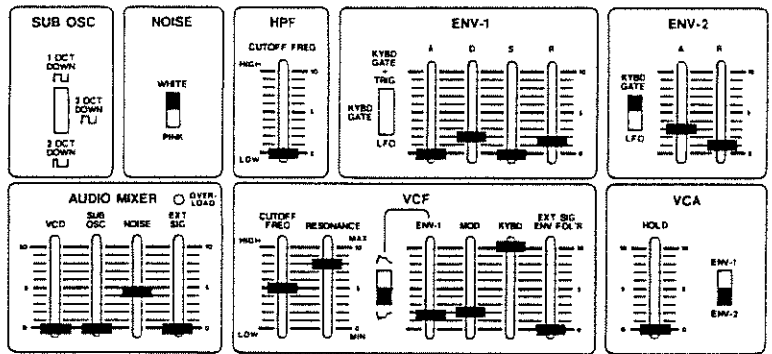

### 3. Producing a Sine Wave

The settings on the right produce a sound a little like a celesta. The VCF CUTOFF FREQ control acts as a tuning control. Notice the differences in the sound for different settings of the CUTOFF FREQ control.

A xylophone-like sound can be produced by lowering both "D" and "R" of ENV-1 to about "2". Envelope control of the oscillating VCF can be used for synthesizing animal sounds, natural sounds, and sound effects (see pp. 41-44).

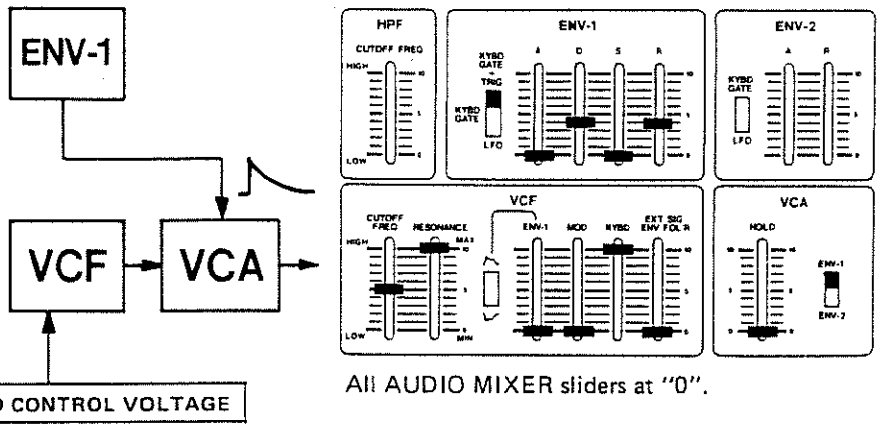

### 4. Pitched Noise

Try adding noise to the settings shown in (3) above. This is done in the same way as (2) whistling above by setting the VCF RESONANCE control just below the point where the VCF starts to oscillate, or at about "7.5". Try various settings of ENV-1. You can make the sound of maracas this way (see p. 36).

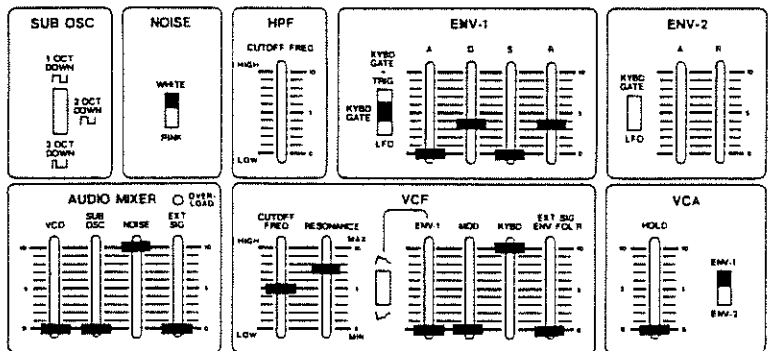

# SYNTHESIZING SOUNDS 7. VARIATIONS IN TONE COLOR CHANGES - VIOLIN

## ■ BASIC SETTING FOR VIOLIN

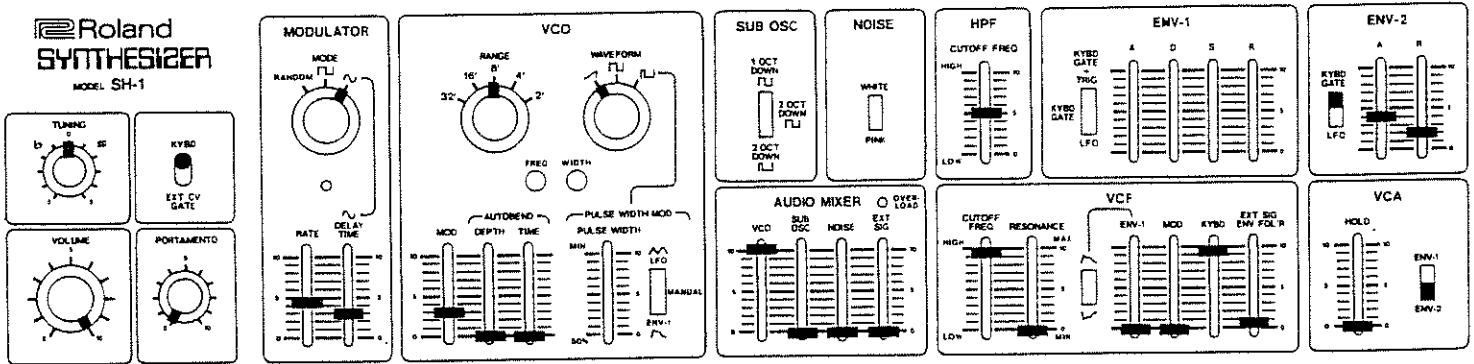

When synthesizing sounds with the synthesizer, it is recommended to start with a setting for the sound of a conventional acoustical instrument, then proceed to make variations on that sound. This method is very effective for becoming familiar with synthesizer functions as well as with the actual synthesis of sounds you like.

The Sound Examples in this manual include settings for 18 acoustical instruments. By gradually modifying the sounds into variations, a large number of sounds can be produced.

What follows is an example of the method to use in producing variations.

### 1. Effect of Pitch Variation

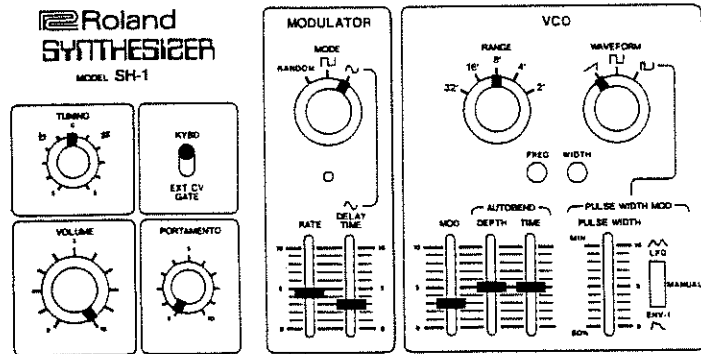

### 2. Changing the Range

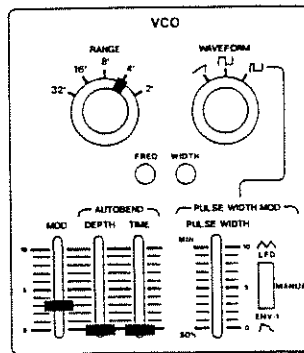

### 3. Changing the Waveform

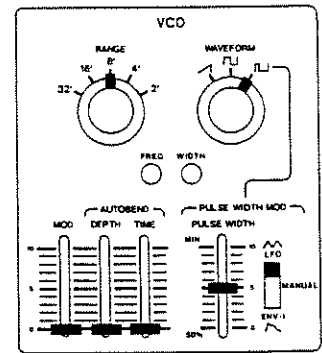

### 4. Changing the VCF Setting

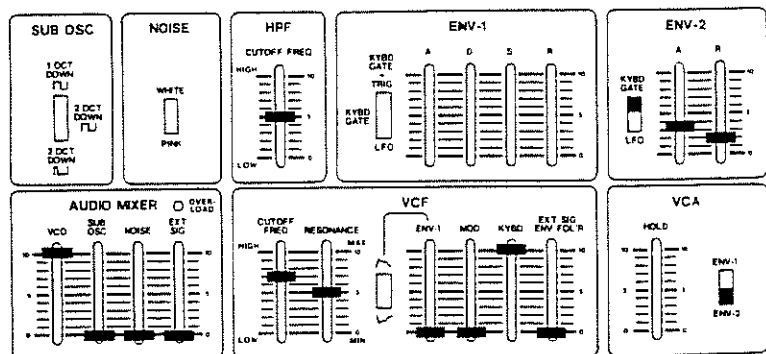

## VARIATION OF BASIC SETTING

The setting at the top of this page is an example of a setting for a violin sound. Try to make some variations on this. First change the depth and speed of vibrato, portamento and autobend effects. The resulting sound will be fairly different from that of the basic setting.

Then change the range and waveform, which will greatly vary the sound.

With the settings shown in (3), the waveform is set at  $\square$  and modulated by the LFO, which will cause a largely "electronic" sound. When the range is changed greatly, the sound will become quite different (for example, bass sound at 32').

Now, change the VCF settings as shown in (4). The result will be a completely different, new sound unique to the synthesizer. Use 8' or 16' PWM wave (setting of (3)) to produce interesting tone color.

# SYNTHESIZING SOUNDS 8. VARIATIONS IN TONE COLOR CHANGES - TRUMPET

## ■ BASIC SETTING FOR TRUMPET

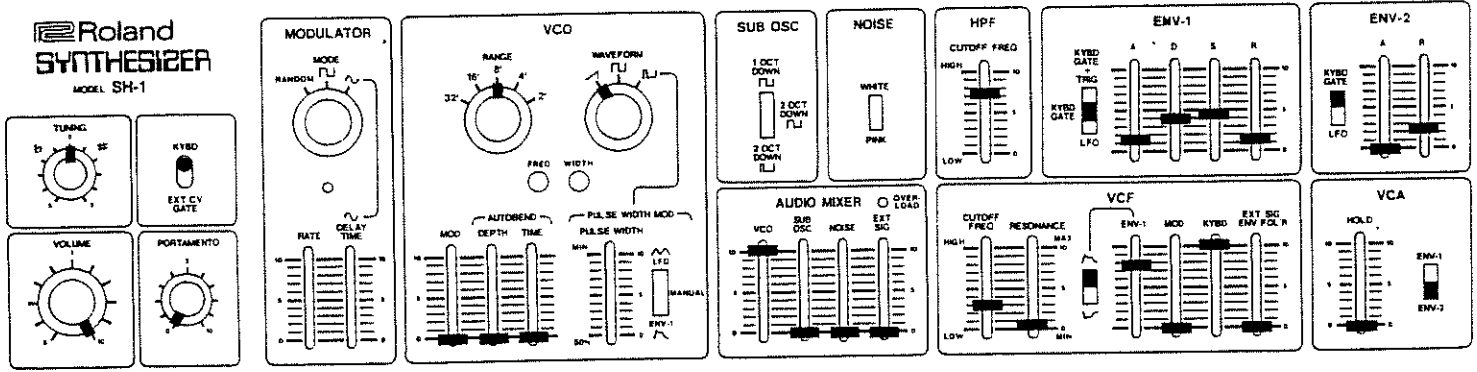

The basic setting on the top of this page produces a trumpet sound. Try small changes in the VCF ENV-1 slider. The sound will vary from a bright trumpet sound to a soft sound. Now, let's experiment with the influence of pitch variation as in the case of violin sound. Change the setting as shown in (1) at the right. Autobend or vibrato will be in effect. Try a little portamento.

### 1. Effect of Pitch Variation

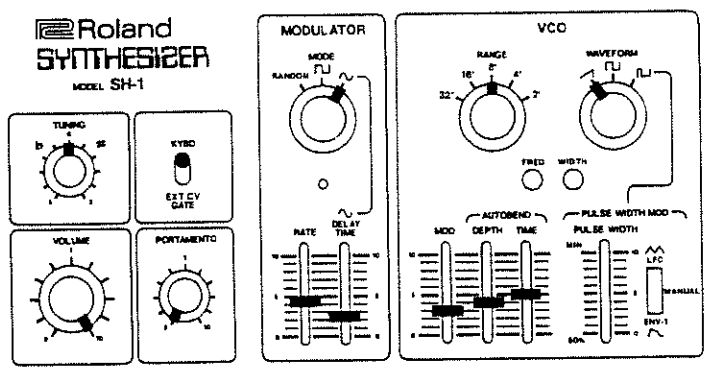

Next, change the RANGE and WAVEFORM switches. Try the settings in (2), and a tuba-like sound will result. Try the settings in (3) for a synthesizer-like trumpet.

### 2. Changing the Range

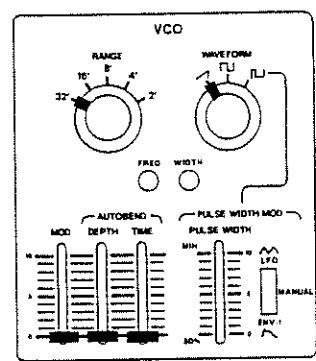

### 3. Changing the Waveform

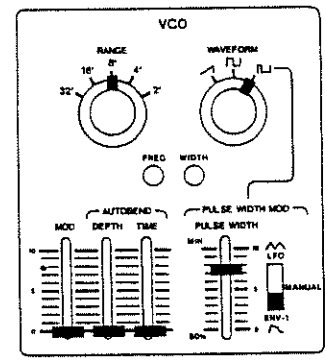

With the VCO setting of (3) try the VCF setting in (4). Wah effects will be added to the trumpet-like sound, which is one of the sounds peculiar to the synthesizer. By adding the Sub-oscillator output, the sound will become heavier.

### 4. Changing the VCF Setting

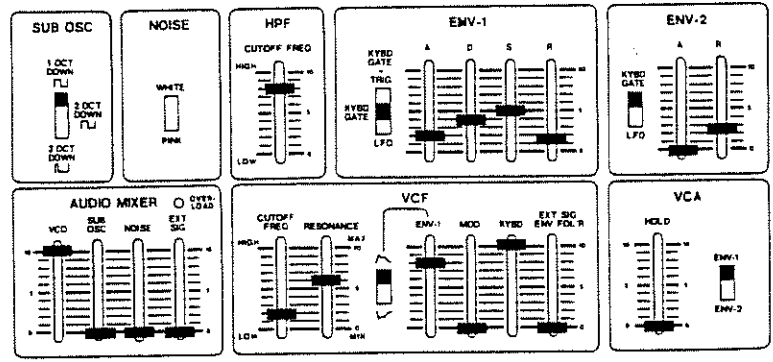

Use the above methods to try variations of other settings shown in this book.

In the above variations, there were no changes made in the envelope setting. Changes in the envelope will greatly change the tone color. The setting of "A" (attack time) is very especially important.

Vary "A" slightly depending on the phrasing effects desired during playing.

# 1 FLUTE

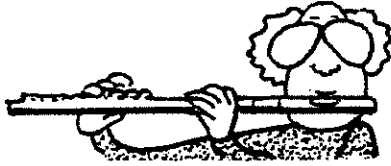

The flute sound is made from a filtered sawtooth wave. Try playing the following passage using an organ or string synthesizer for the chords.



**Roland SYNTHESIZER MODEL SH-1**

Control panel settings for Flute sound:

- Tuning:** 12
- Volume:** 10
- Portamento:** 10
- Keyboard Gate:** ON
- Modulator:** MODE: FU, RATE: 10, DELAY TIME: 10
- VCO:** RANGE: 16, WAVEFORM: FU, FREQ: 32, WIDTH: 4
- Sub Osc:** 1 OCT DOWN, 2 OCT DOWN
- Noise:** WHITE
- HPF:** CUTOFF FREQ: 1
- Audio Mixer:** VCO, SUB OSC, NOISE, EXT SIG
- VCF:** CUTOFF FREQ: 1, RESONANCE: 1, ENV-1: 1, MOD: 1, KYBD: 1, EXT SIG: 1
- VCA:** HOLD: 1, ENV-1: 1, ENV-2: 1

# 2 CLARINET

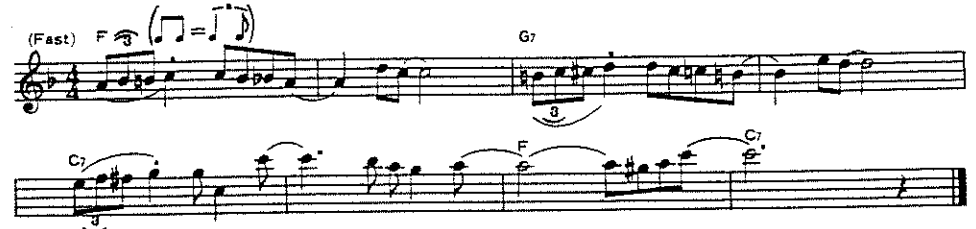
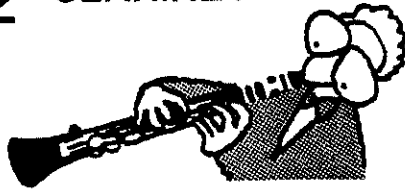

**Roland SYNTHESIZER MODEL SH-1**

Control panel settings for Clarinet sound:

- Tuning:** 12
- Volume:** 10
- Portamento:** 10
- Keyboard Gate:** ON
- Modulator:** MODE: FU, RATE: 10, DELAY TIME: 10
- VCO:** RANGE: 16, WAVEFORM: FU, FREQ: 32, WIDTH: 4
- Sub Osc:** 1 OCT DOWN, 2 OCT DOWN
- Noise:** WHITE
- HPF:** CUTOFF FREQ: 1
- Audio Mixer:** VCO, SUB OSC, NOISE, EXT SIG
- VCF:** CUTOFF FREQ: 1, RESONANCE: 1, ENV-1: 1, MOD: 1, KYBD: 1, EXT SIG: 1
- VCA:** HOLD: 1, ENV-1: 1, ENV-2: 1

# 3 OBOE



The most difficult part of synthesizing the oboe sound is the setting of the VCF CUTOFF FREQ and RESONANCE controls; this should be done while actually

playing notes. Also, the modulator section RATE and DELAY TIME controls and the VCO MOD control can be varied slightly depending on the feeling desired.

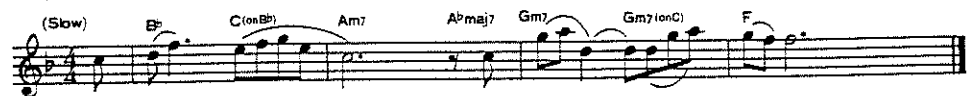

**Roland SYNTHESIZER MODEL SH-1**

Control panel settings for Oboe sound:

- Tuning:** 12
- Volume:** 10
- Portamento:** 10
- Keyboard Gate:** ON
- Modulator:** MODE: FU, RATE: 10, DELAY TIME: 10
- VCO:** RANGE: 16, WAVEFORM: FU, FREQ: 32, WIDTH: 4
- Sub Osc:** 1 OCT DOWN, 2 OCT DOWN
- Noise:** WHITE
- HPF:** CUTOFF FREQ: 1
- Audio Mixer:** VCO, SUB OSC, NOISE, EXT SIG
- VCF:** CUTOFF FREQ: 1, RESONANCE: 1, ENV-1: 1, MOD: 1, KYBD: 1, EXT SIG: 1
- VCA:** HOLD: 1, ENV-1: 1, ENV-2: 1



# 4 TRUMPET

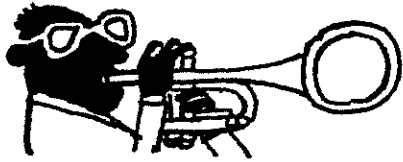

There are various trumpet sounds, depending on the playing style. This setting is a little different from the setting shown on page 30 in order to produce the sound of a

trumpet in a march. The settings of ENV-1 and the VCF CUTOFF FREQ are important.

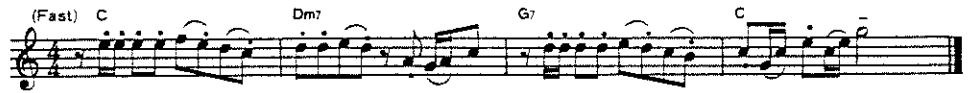

**Roland SYNTHESIZER MODEL SH-1**

**MODULATOR**: MODE (RANDOM), RATE, DELAY TIME.

**VCO**: RANGE (32', 16', 8', 4', 2'), FREQ, WIDTH, WAVEFORM (S, T, R, L, J, U), PULSE WIDTH MOD (MIN, MAX, ENV-1, MANUAL), AUTOBEND (MOD, DEPTH, TIME), LFO.

**SUB OSC**: 1 OCT DOWN, 2 OCT DOWN, 2 OCT DOWN.

**NOISE**: WHITE, PINK.

**HPF**: CUTOFF FREQ (HIGH, LOW).

**ENV-1**: KYBD GATE (TRIG, LFO), A, D, S, R.

**ENV-2**: KYBD GATE (TRIG, LFO), A, R.

**AUDIO MIXER**: VCO, SUB OSC, NOISE, EXT SIG, OVERLOAD.

**VCF**: CUTOFF FREQ (HIGH, LOW), RESONANCE (MAX, MIN), ENV-1, MOD, KYBD, EXT SIG, ENV FOL, R.

**VCA**: HOLD, ENV-1, ENV-2.

# 5 HORN

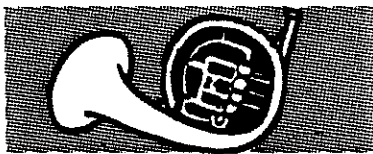

The horn sound is very similar to the trumpet sound and will depend a great deal on the ENV-1 settings, particularly the "A" setting. The setting shown below

is basic and will depend on the style of the music being played.



**Roland SYNTHESIZER MODEL SH-1**

**MODULATOR**: MODE (RANDOM), RATE, DELAY TIME.

**VCO**: RANGE (32', 16', 8', 4', 2'), FREQ, WIDTH, WAVEFORM (S, T, R, L, J, U), PULSE WIDTH MOD (MIN, MAX, ENV-1, MANUAL), AUTOBEND (MOD, DEPTH, TIME), LFO.

**SUB OSC**: 1 OCT DOWN, 2 OCT DOWN, 2 OCT DOWN.

**NOISE**: WHITE, PINK.

**HPF**: CUTOFF FREQ (HIGH, LOW).

**ENV-1**: KYBD GATE (TRIG, LFO), A, D, S, R.

**ENV-2**: KYBD GATE (TRIG, LFO), A, R.

**AUDIO MIXER**: VCO, SUB OSC, NOISE, EXT SIG, OVERLOAD.

**VCF**: CUTOFF FREQ (HIGH, LOW), RESONANCE (MAX, MIN), ENV-1, MOD, KYBD, EXT SIG, ENV FOL, R.

**VCA**: HOLD, ENV-1, ENV-2.

# 6 TUBA

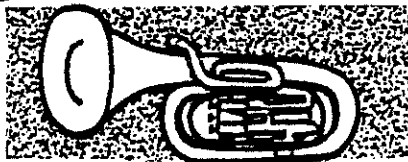

As with the other brass sounds, the VCF CUTOFF FREQ and ENV-1 settings are important.

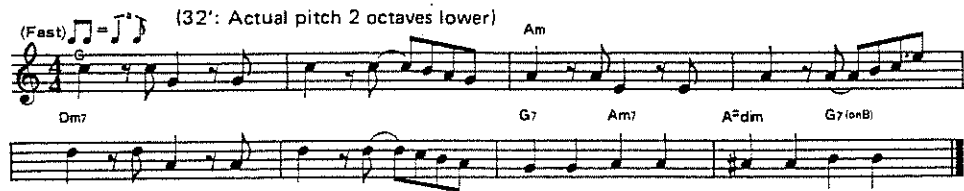

**Roland SYNTHESIZER MODEL SH-1**

**MODULATOR**: MODE (RANDOM), RATE, DELAY TIME.

**VCO**: RANGE (32', 16', 8', 4', 2'), FREQ, WIDTH, WAVEFORM (S, T, R, L, J, U), PULSE WIDTH MOD (MIN, MAX, ENV-1, MANUAL), AUTOBEND (MOD, DEPTH, TIME), LFO.

**SUB OSC**: 1 OCT DOWN, 2 OCT DOWN, 2 OCT DOWN.

**NOISE**: WHITE, PINK.

**HPF**: CUTOFF FREQ (HIGH, LOW).

**ENV-1**: KYBD GATE (TRIG, LFO), A, D, S, R.

**ENV-2**: KYBD GATE (TRIG, LFO), A, R.

**AUDIO MIXER**: VCO, SUB OSC, NOISE, EXT SIG, OVERLOAD.

**VCF**: CUTOFF FREQ (HIGH, LOW), RESONANCE (MAX, MIN), ENV-1, MOD, KYBD, EXT SIG, ENV FOL, R.

**VCA**: HOLD, ENV-1, ENV-2.

# 7 VIOLIN

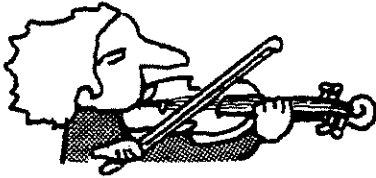

The modulator RATE and DELAY TIME controls and the VCO MOD control are important to producing a violin-like sound and will often depend on the style of music being played.



**Roland SYNTHESIZER MODEL SH-1**

# 8 CELLO



Try adding a little portamento effect.

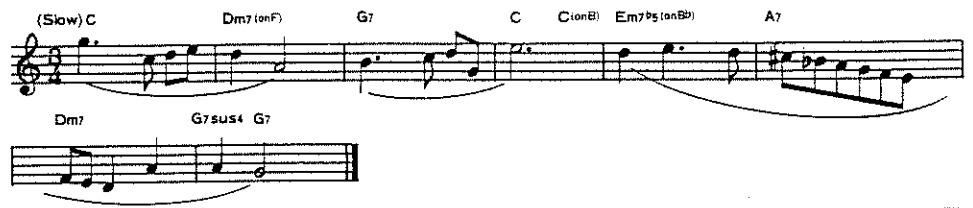

**Roland SYNTHESIZER MODEL SH-1**

# 9 E. BASS GUITAR

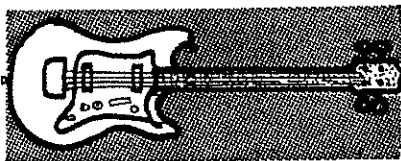

(32': Actual pitch 2 octaves lower)  
(Fast) C7



**Roland SYNTHESIZER MODEL SH-1**

# 10 HARPSICHORD

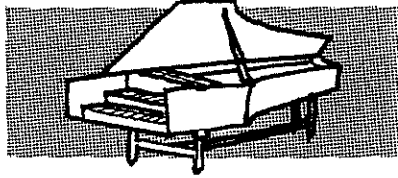

The VCO RANGE will depend on the music being played. It is also possible to use the sawtooth wave. The setting below

uses the pulse wave; try changing the PULSE WIDTH or using LFO or ENV-1 modulation.



**Roland SYNTHESIZER MODEL SH-1**

<b>TUNING</b>	<b>KYBD EXT. CV GATE</b>	<b>MODULATOR</b>	<b>VCO</b>	<b>SUB OSC</b>	<b>NOISE</b>	<b>HPF</b>	<b>ENV-1</b>	<b>ENV-2</b>
<b>VOLUME</b>	<b>PORTAMENTO</b>	<b>RATE</b>	<b>AUTOBEND</b>	<b>AUDIO MIXER</b>	<b>VCF</b>	<b>VCA</b>		

# 11 ELECTRIC PIANO



There are many sounds which could be called electric piano. Set the VCF CUTOFF FREQ control for the sound you like. Also

try raising the VCF ENV-1 control.



**Roland SYNTHESIZER MODEL SH-1**

<b>TUNING</b>	<b>KYBD EXT. CV GATE</b>	<b>MODULATOR</b>	<b>VCO</b>	<b>SUB OSC</b>	<b>NOISE</b>	<b>HPF</b>	<b>ENV-1</b>	<b>ENV-2</b>
<b>VOLUME</b>	<b>PORTAMENTO</b>	<b>RATE</b>	<b>AUTOBEND</b>	<b>AUDIO MIXER</b>	<b>VCF</b>	<b>VCA</b>		

# 12 ACCORDION



The accordion sound uses the 4' LFO modulated pulse wave mixed with the SUB OSC square wave. The tone color will

depend on the balance of the two AUDIO MIXER controls. Also, try varying the VCF CUTOFF FREQ.



**Roland SYNTHESIZER MODEL SH-1**

<b>TUNING</b>	<b>KYBD EXT. CV GATE</b>	<b>MODULATOR</b>	<b>VCO</b>	<b>SUB OSC</b>	<b>NOISE</b>	<b>HPF</b>	<b>ENV-1</b>	<b>ENV-2</b>
<b>VOLUME</b>	<b>PORTAMENTO</b>	<b>RATE</b>	<b>AUTOBEND</b>	<b>AUDIO MIXER</b>	<b>VCF</b>	<b>VCA</b>		

# 13 XYLOPHONE



The most critical points in this setting are the VCF CUTOFF FREQ and VCF RESONANCE. If the ENV-1 switch is set to LFO, the sound will be repeated at a rate

determined by the modulator RATE control.



**Roland SYNTHESIZER MODEL SH-1**

# 14 VIBRAPHONE

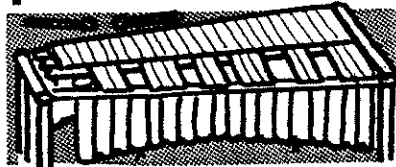

This sound uses the VCO square wave combined with the SUB OSC square wave two octaves lower. Adjust the VCF CUTOFF FREQ and the VCF ENV-1

controls to produce the desired sound. The VCF MOD slider controls the depth of the vibraphone tremolo effect.



**Roland SYNTHESIZER MODEL SH-1**

# 15 GLOCKENSPIEL

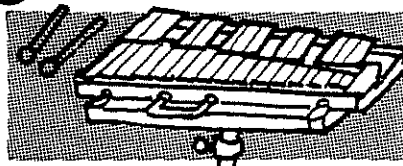

The critical points in this setting, like the xylophone, are the VCF CUTOFF FREQ and RESONANCE.



**Roland SYNTHESIZER MODEL SH-1**

# 16 SNARE DRUM

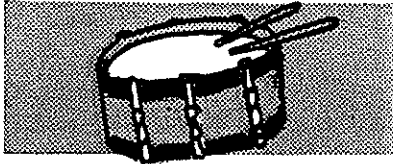

The snare drum sound is a combination of the drum tone with the rattling of the snares. The drum tone is produced with the VCO 16' square wave and the sound of the snares with white noise; be careful of the mixing levels. The drum pitch will depend on which key is used; probably somewhere

near the center of the keyboard would be best. With the ENV-1 gate trigger selector switch at LFO as shown, a snare drum roll is produced.

**Roland SYNTHESIZER MODEL SH-1**

Control panel for Snare Drum sound. Includes Tuning, KYBD, Volume, Portamento, Modulator, VCO, Sub Osc, Noise, HPF, ENV-1, ENV-2, Audio Mixer, VCF, and VCA sections.

# 17 CLAVES



Like most percussion instruments, this sound has a very short decay/release time. The quality of the sound will depend on which key is used; in this case use C2 (the C just to the right of the center of the keyboard).

Various percussion sounds can be produced by varying the VCF CUTOFF FREQ setting. For example, with the CUTOFF FREQ at about "3" and the ENV-1 "D" and "R" controls at "4", the sound of a steel drum is produced.

Various percussion sounds can be produced

**Roland SYNTHESIZER MODEL SH-1**

Control panel for Claves sound. Includes Tuning, KYBD, Volume, Portamento, Modulator, VCO, Sub Osc, Noise, HPF, ENV-1, ENV-2, Audio Mixer, VCF, and VCA sections.

# 18 MARACAS



This sound is made with noise. Again, the VCF settings are critical. Also, try variations of the ENV-1 controls. The tone quality will depend on which key is depressed.

**Roland SYNTHESIZER MODEL SH-1**

Control panel for Maracas sound. Includes Tuning, KYBD, Volume, Portamento, Modulator, VCO, Sub Osc, Noise, HPF, ENV-1, ENV-2, Audio Mixer, VCF, and VCA sections.

# 19 FUNNY CAT

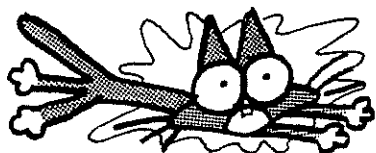

The VCF with the RESONANCE control raised is controlled by ENV-1 to produce tone color changes each time a key is depressed. Set the ENV-1 "D" control

at "3" and the "S" control at "2" to produce "wah" sounds.



**Roland SYNTHESIZER MODEL SH-1**

TUNING	KYBD	MODULATOR	VCO	SUB OSC	NOISE	HPF	ENV-1	ENV-2
VOLUME	PORTAMENTO	RATE	AUTOBEND	AUDIO MIXER	CUTOFF FREQ	RESONANCE	VCF	VCA

# 20 PULSAR

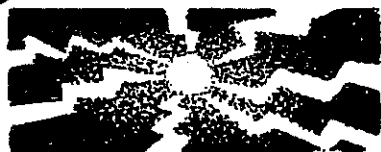

This is a very electronic sound. Adjust ENV-1 "R" to match the music being played. Lower "R" for long phrases.



**Roland SYNTHESIZER MODEL SH-1**

TUNING	KYBD	MODULATOR	VCO	SUB OSC	NOISE	HPF	ENV-1	ENV-2
VOLUME	PORTAMENTO	RATE	AUTOBEND	AUDIO MIXER	CUTOFF FREQ	RESONANCE	VCF	VCA

# 21 SUPER COMBINATION



This is a large sound combining the VCO output with the SUB OSC. Many variations can be produced by changing the ENV-1 settings. Also try VCO RANGE settings of

8' or 16' for heavy sounds.



**Roland SYNTHESIZER MODEL SH-1**

TUNING	KYBD	MODULATOR	VCO	SUB OSC	NOISE	HPF	ENV-1	ENV-2
VOLUME	PORTAMENTO	RATE	AUTOBEND	AUDIO MIXER	CUTOFF FREQ	RESONANCE	VCF	VCA

# 22 POPCORN

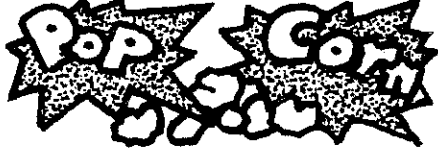

This is a very percussive sound. If the ENV-1 gate trigger selector switch is set at LFO, the sound will repeat at a rate determined by the modulator RATE

control. Try different VCO WAVEFORM and RANGE settings. Also try raising the VCF RESONANCE control.



Roland  
SYNTHESIZER  
MODEL SH-1

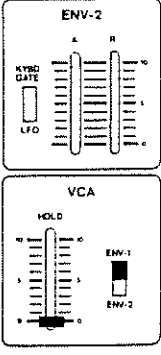
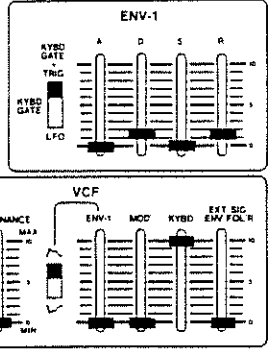
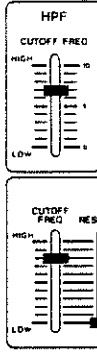
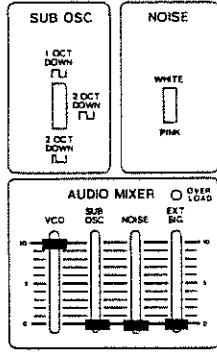
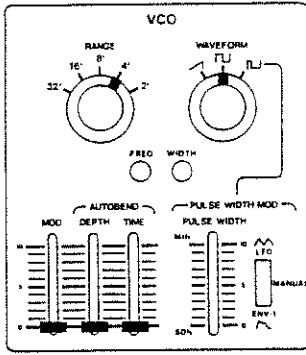
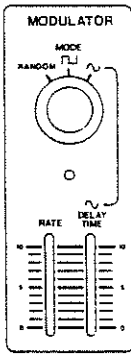
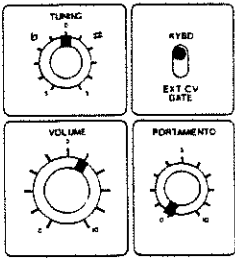

# 23 COOL WATER



This sound uses a square wave with auto-bend to produce a quick rise in pitch at the start of each note. Staccato works well with this sound. Try different VCO

waveforms. Also try LFO modulation of the pulse wave. Set the AUTOBEND TIME slider as desired.

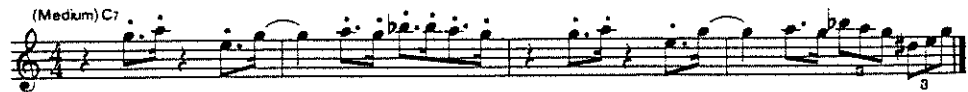

Roland  
SYNTHESIZER  
MODEL SH-1

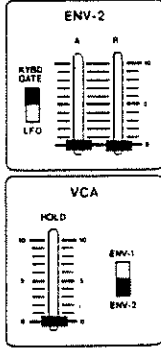
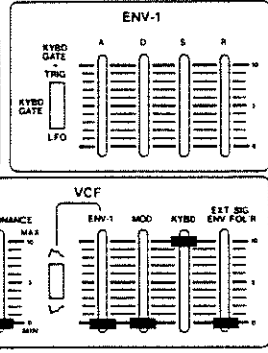
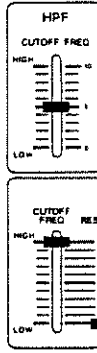
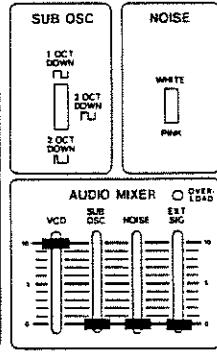
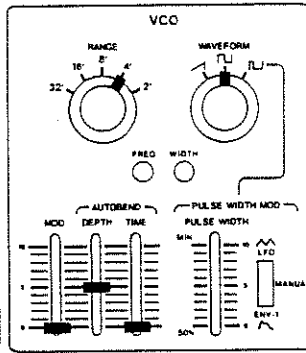
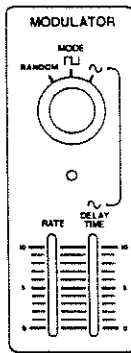
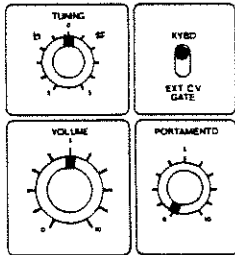

# 24 FANTASY

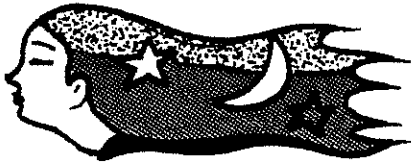

Try variations of the VCO MOD slider and the modulator RATE and DELAY TIME.

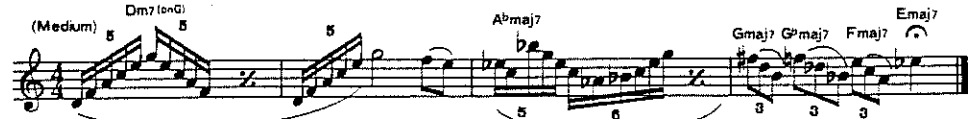

Roland  
SYNTHESIZER  
MODEL SH-1

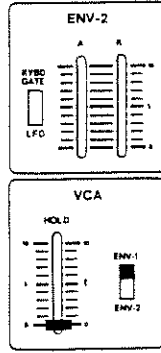
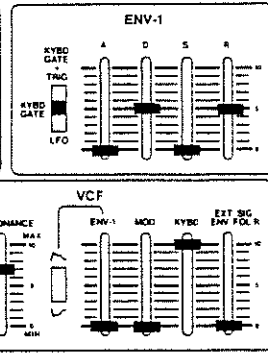
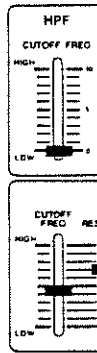
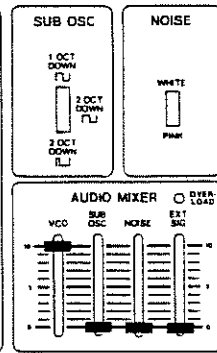
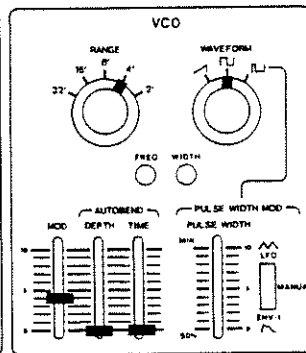
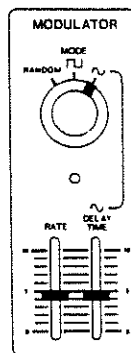
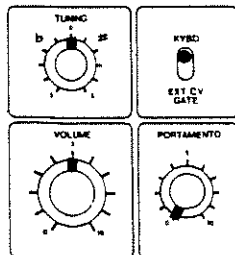

# 25 SYNTHESIZER HARP

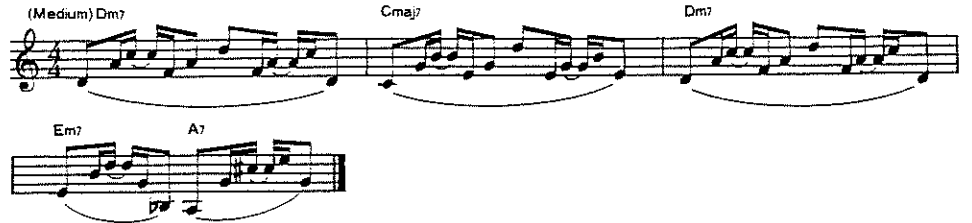
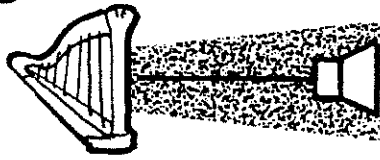

**Roland SYNTHESIZER MODEL SH-1**

TUNING	KYBD	MODULATOR	VCO	SUB OSC	NOISE	HPF	ENV-1	ENV-2
VOLUME	PORTAMENTO	RATE	AUTOBEND	AUDIO MIXER	CUTOFF FREQ	VCF	VCA	

# 26 SYNTHESIZER VOICE

A warm, human voice-like, synthesizer sound.

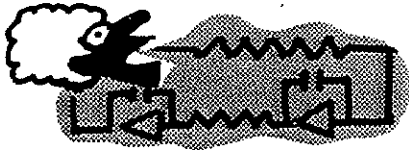

**Roland SYNTHESIZER MODEL SH-1**

TUNING	KYBD	MODULATOR	VCO	SUB OSC	NOISE	HPF	ENV-1	ENV-2
VOLUME	PORTAMENTO	RATE	AUTOBEND	AUDIO MIXER	CUTOFF FREQ	VCF	VCA	

# 27 FUNK BASS

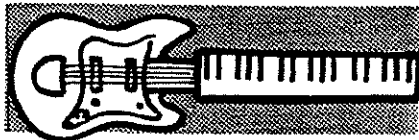

**Roland SYNTHESIZER MODEL SH-1**

TUNING	KYBD	MODULATOR	VCO	SUB OSC	NOISE	HPF	ENV-1	ENV-2
VOLUME	PORTAMENTO	RATE	AUTOBEND	AUDIO MIXER	CUTOFF FREQ	VCF	VCA	



# 28 PHASE GUITAR

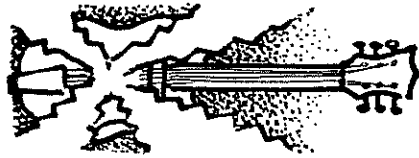

All the sounds on this page are good for ad lib. Use pitch bend with this sound.

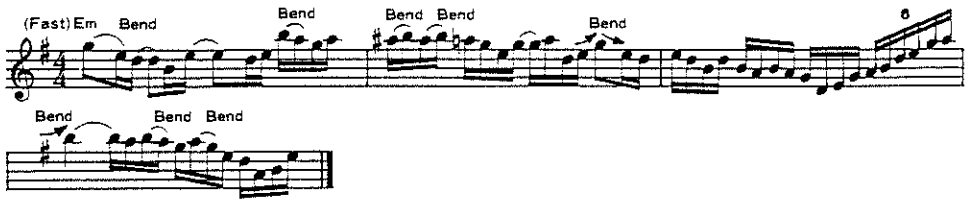

**Roland SYNTHESIZER MODEL SH-1**

TUNING	KYBD EXT CV GATE	MODULATOR	VCO	SUB OSC	NOISE	HPF	ENV-1	ENV-2
VOLUME	PORTAMENTO	RATE DELAY TIME	AUTOBEND MOD DEPTH TIME PULSE WIDTH MOD PULSE WIDTH	AUDIO MIXER	CUTOFF FREQ RESONANCE	VCF	VCA	

# 29 FUNKY

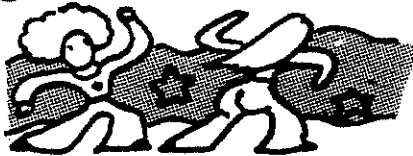

Use BENDER control of the VCF with this sound.

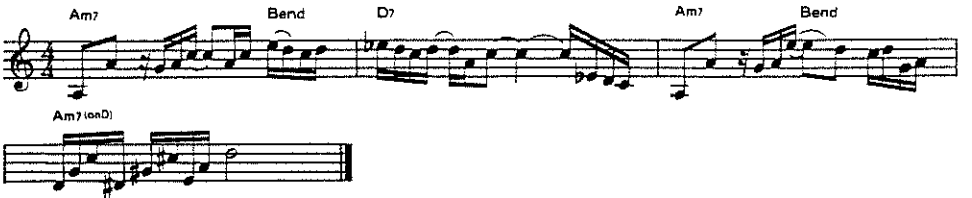

**Roland SYNTHESIZER MODEL SH-1**

TUNING	KYBD EXT CV GATE	MODULATOR	VCO	SUB OSC	NOISE	HPF	ENV-1	ENV-2
VOLUME	PORTAMENTO	RATE DELAY TIME	AUTOBEND MOD DEPTH TIME PULSE WIDTH MOD PULSE WIDTH	AUDIO MIXER	CUTOFF FREQ RESONANCE	VCF	VCA	

# 30 JAZZ ORGAN

Raising the VCF ENV-1 control with all ENV-1 sliders at "0" produces organ key click noise.

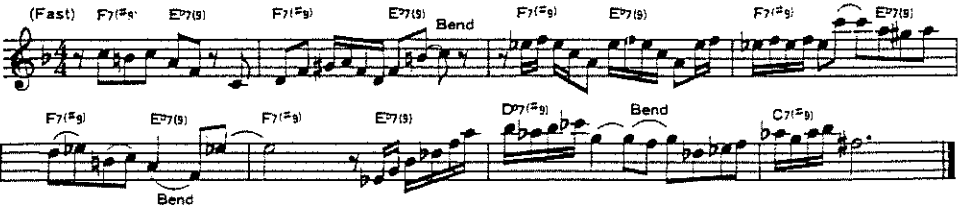

**Roland SYNTHESIZER MODEL SH-1**

TUNING	KYBD EXT CV GATE	MODULATOR	VCO	SUB OSC	NOISE	HPF	ENV-1	ENV-2
VOLUME	PORTAMENTO	RATE DELAY TIME	AUTOBEND MOD DEPTH TIME PULSE WIDTH MOD PULSE WIDTH	AUDIO MIXER	CUTOFF FREQ RESONANCE	VCF	VCA	

### 31 HUMAN VOICE (FEMALE)

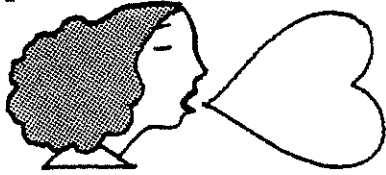

When synthesizing the human voice, the most difficult settings are the VCF CUTOFF FREQ and RESONANCE; set these while listening to the sound. Try adding a little portamento. To produce a "wah" sound, set the ENV-1 controls at: A=0; D=2; S=0; R=2; and the VCF ENV-1 control at "3".

**Roland SYNTHESIZER MODEL SH-1**

Control panel settings for Human Voice (Female):

- MODULATOR:** MODE: RANDOM; RATE: 1; DELAY TIME: 1.
- VCO:** RANGE: 16; WAVEFORM: FU; FREQ: 32; WIDTH: 2; AUTOBEND: MOD 0, DEPTH 0, TIME 0; PULSE WIDTH MOD: MIN; LFO: ENV 1.
- SUB OSC:** 1 OCT DOWN, 2 OCT DOWN.
- NOISE:** WHITE, PINK.
- HPF:** CUTOFF FREQ: 10.
- ENV-1:** KYBD GATE: TRIG; A: 0; D: 2; S: 0; R: 2.
- ENV-2:** KYBD GATE: LFO; A: 1; R: 1.
- VOLUME:** 10.
- PORTAMENTO:** 10.
- AUDIO MIXER:** VCO, SUB OSC, NOISE, EXT SIG, OVER LOAD.
- VCF:** CUTOFF FREQ: 10; RESONANCE: 10; ENV-1: 3; MOD: 0; KYBD: 0; EXT SIG: 0; ENV FOL: R.
- VCA:** HOLD: 0; ENV-1: 0; ENV-2: 0.

### 32 DOG BARK

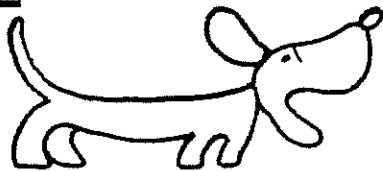

The dog bark is made with an oscillating VCF. With the VCF ENV-1 control raised, the frequency of the oscillating VCF is controlled by the shape of the envelope. Pressing different keys will produce different dogs. Changing the VCF CUTOFF FREQ will also cause large changes in the

sound. To produce a howling dog, set the ENV-1 "S" control at "7", press a key, then move the "S" control up and down.

**Roland SYNTHESIZER MODEL SH-1**

Control panel settings for Dog Bark:

- MODULATOR:** MODE: RANDOM; RATE: 1; DELAY TIME: 1.
- VCO:** RANGE: 16; WAVEFORM: FU; FREQ: 32; WIDTH: 2; AUTOBEND: MOD 0, DEPTH 0, TIME 0; PULSE WIDTH MOD: MIN; LFO: ENV 1.
- SUB OSC:** 1 OCT DOWN, 2 OCT DOWN.
- NOISE:** WHITE, PINK.
- HPF:** CUTOFF FREQ: 10.
- ENV-1:** KYBD GATE: TRIG; A: 0; D: 0; S: 7; R: 0.
- ENV-2:** KYBD GATE: LFO; A: 1; R: 1.
- VOLUME:** 10.
- PORTAMENTO:** 10.
- AUDIO MIXER:** VCO, SUB OSC, NOISE, EXT SIG, OVER LOAD.
- VCF:** CUTOFF FREQ: 10; RESONANCE: 10; ENV-1: 3; MOD: 0; KYBD: 0; EXT SIG: 0; ENV FOL: R.
- VCA:** HOLD: 0; ENV-1: 0; ENV-2: 0.

### 33 CHIRPING BIRDS

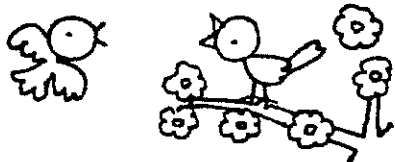

Pressing a key produces bird chirps. Various birds can be produced by pressing different keys. This sound also depends on ENV-1 control of the oscillating VCF. The ENV-1 gate trigger selector switch is at LFO so that the sound repeats at the rate determined by the modulator RATE setting.

**Roland SYNTHESIZER MODEL SH-1**

Control panel settings for Chirping Birds:

- MODULATOR:** MODE: RANDOM; RATE: 1; DELAY TIME: 1.
- VCO:** RANGE: 16; WAVEFORM: FU; FREQ: 32; WIDTH: 2; AUTOBEND: MOD 0, DEPTH 0, TIME 0; PULSE WIDTH MOD: MIN; LFO: ENV 1.
- SUB OSC:** 1 OCT DOWN, 2 OCT DOWN.
- NOISE:** WHITE, PINK.
- HPF:** CUTOFF FREQ: 10.
- ENV-1:** KYBD GATE: TRIG; A: 0; D: 0; S: 0; R: 0.
- ENV-2:** KYBD GATE: LFO; A: 1; R: 1.
- VOLUME:** 10.
- PORTAMENTO:** 10.
- AUDIO MIXER:** VCO, SUB OSC, NOISE, EXT SIG, OVER LOAD.
- VCF:** CUTOFF FREQ: 10; RESONANCE: 10; ENV-1: 3; MOD: 0; KYBD: 0; EXT SIG: 0; ENV FOL: R.
- VCA:** HOLD: 0; ENV-1: 0; ENV-2: 0.

# 34 WIND

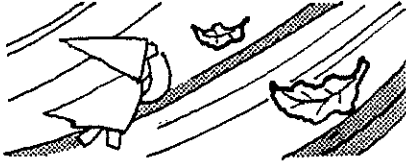

Wind is produced with pink noise passed through the VCF with the RESONANCE control raised. To produce the changes as the wind blows, it is necessary to move the VCF CUTOFF FREQ; this can be done by hand, or it can be done by means of the modulator (VCF MOD control raised)

as shown below. The VCA HOLD slider is up so that pressing a key is not necessary to produce sound.

**Roland SYNTHESIZER MODEL SH-1**

# 35 SURF

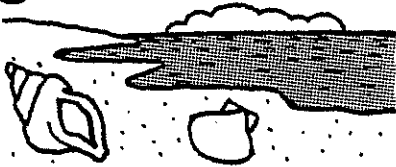

The setting for surf is very much like the setting for the wind; by changing only the VCF settings, wave-like sounds are produced. The setting below uses white noise, but pink noise works well, too. Try different VCF settings for different types of waves. If you raise the RESONANCE

control, you will bring the wind sound back.

**Roland SYNTHESIZER MODEL SH-1**

# 36 RAINDROPS



Pressing a key produces raindrops. This setting uses the oscillating VCF and like the (33) Chirping Birds setting, uses ENV-1 to control the VCF frequency. The main difference is that the raindrops uses an inverted (∩) envelope. This setting also uses the RANDOM setting of the modulator

selector switch. The ENV-1 "D" and "R" controls should be set very near "1".

**Roland SYNTHESIZER MODEL SH-1**

# 37 STEAM LOCOMOTIVE

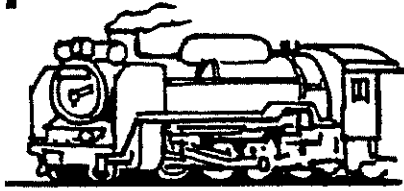

The steam locomotive uses pink noise. Small changes in the VCF CUTOFF FREQ and ENV-1 controls will produce different types of sounds. With the ENV-1 gate trigger switch at LFO, the modulator RATE slider controls the speed of the locomotive. Experiment with the ENV-1

controls. The feeling of the sound will change depending on which keys are pressed.

**Roland SYNTHESIZER MODEL SH-1**

# 38 MACHINE GUN

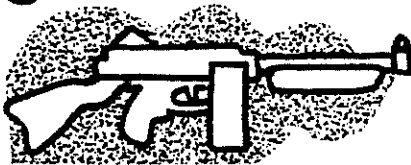

This sound is made with noise. Pressing a key produces machine gun shots. When the key is released, the last shot will be a ricochet. The modulator RATE controls the speed of the shots. As above, the envelope is triggered by the modulator. The VCF CUTOFF FREQ and RESONANCE

settings are very critical.

**Roland SYNTHESIZER MODEL SH-1**

# 39 EUROPEAN POLICE



In this setting, the VCO MOD control should be set so that the VCO pitches are a major third apart (if the lower pitch is C, the upper should be E). A siren can be produced by changing the modulator selector to , moving the RATE control to "0", and moving the VCO MOD control

to "10". In this setting, pressing a key causes the sound to approach from a distance; releasing the key causes the sound to fade away.

**Roland SYNTHESIZER MODEL SH-1**

# 40 MOTORCYCLE

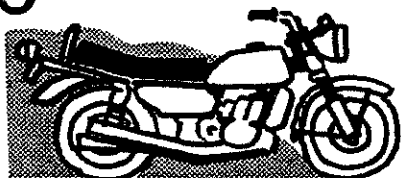

Set the TRANSPOSE switch at L. Pressing the lowest key starts the engine. Next, pressing the highest key will cause the motorcycle to move. While holding this key down, the VCO MOD control causes the motorcycle speed to vary. Releasing the key will cause the motorcycle to fade

into the distance.

Roland  
SYNTHESIZER  
MODEL SH-1

TUNING: 0 to 32

VOLUME: 0 to 10

PORTAMENTO: 0 to 10

KYBD EXT CV GATE

MODULATOR: MODE (RANDOM), RATE, DELAY TIME

VCO: RANGE (32, 16, 8, 4, 2), WAVEFORM, FREQ, WIDTH, AUTOBEND (MOD, DEPTH, TIME), PULSE WIDTH MOD (PULSE WIDTH, LFO, ENV-1, MANUAL)

SUB OSC: 1 OCT DOWN, 2 OCT DOWN, 3 OCT DOWN

NOISE: WHITE, PINK

HPF: CUTOFF FREQ (HIGH, LOW)

ENV-1: KYBD GATE, TRIG, LFO, A, D, S, R

ENV-2: KYBD GATE, LFO, A, R

AUDIO MIXER: VCO, SUB OSC, NOISE, EXT SIG, OVER LOAD

VCF: CUTOFF FREQ, RESONANCE, ENV-1, MOD, KYBD, EXT SIG, ENV FOL R

VCA: HOLD, ENV-1, ENV-2

# 41 BOAT

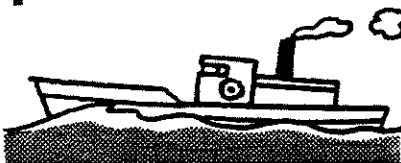

Set the TRANSPOSE switch at L. Press the lowest key. While listening to the sound, adjust all the VCF sliders and the modulator RATE control to get a sound which sounds good. Try lowering the TUNING control. Also try adding a little noise. As above, releasing the key causes

the boat to fade into the distance.

Roland  
SYNTHESIZER  
MODEL SH-1

TUNING: 0 to 32

VOLUME: 0 to 10

PORTAMENTO: 0 to 10

KYBD EXT CV GATE

MODULATOR: MODE (RANDOM), RATE, DELAY TIME

VCO: RANGE (32, 16, 8, 4, 2), WAVEFORM, FREQ, WIDTH, AUTOBEND (MOD, DEPTH, TIME), PULSE WIDTH MOD (PULSE WIDTH, LFO, ENV-1, MANUAL)

SUB OSC: 1 OCT DOWN, 2 OCT DOWN, 3 OCT DOWN

NOISE: WHITE, PINK

HPF: CUTOFF FREQ (HIGH, LOW)

ENV-1: KYBD GATE, TRIG, LFO, A, D, S, R

ENV-2: KYBD GATE, LFO, A, R

AUDIO MIXER: VCO, SUB OSC, NOISE, EXT SIG, OVER LOAD

VCF: CUTOFF FREQ, RESONANCE, ENV-1, MOD, KYBD, EXT SIG, ENV FOL R

VCA: HOLD, ENV-1, ENV-2

# 42 TEMPLE GONG



Set the TRANSPOSE switch at L. The setting combines three sounds: the VCO, SUB OSC, and oscillating VCF to produce gong sounds. Set the VCF CUTOFF FREQ while listening to the output sound. Once adjusted, the tone of the gong will depend on which key is pressed.

Roland  
SYNTHESIZER  
MODEL SH-1

TUNING: 0 to 32

VOLUME: 0 to 10

PORTAMENTO: 0 to 10

KYBD EXT CV GATE

MODULATOR: MODE (RANDOM), RATE, DELAY TIME

VCO: RANGE (32, 16, 8, 4, 2), WAVEFORM, FREQ, WIDTH, AUTOBEND (MOD, DEPTH, TIME), PULSE WIDTH MOD (PULSE WIDTH, LFO, ENV-1, MANUAL)

SUB OSC: 1 OCT DOWN, 2 OCT DOWN, 3 OCT DOWN

NOISE: WHITE, PINK

HPF: CUTOFF FREQ (HIGH, LOW)

ENV-1: KYBD GATE, TRIG, LFO, A, D, S, R

ENV-2: KYBD GATE, LFO, A, R

AUDIO MIXER: VCO, SUB OSC, NOISE, EXT SIG, OVER LOAD

VCF: CUTOFF FREQ, RESONANCE, ENV-1, MOD, KYBD, EXT SIG, ENV FOL R

VCA: HOLD, ENV-1, ENV-2

# 43 UFO

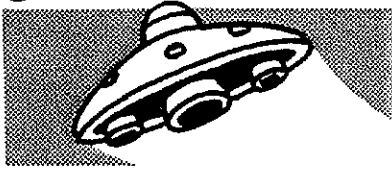

Tapping a key will cause a flying saucer to approach. This sound is produced by an oscillating VCF controlled by ENV-1 and the output of the modulator. ENV-1 causes the overall pitch range of the sound to fall, the modulator wave breaks the sound up. Try different settings of the

VCF CUTOFF FREQ or ENV-1 slider, and also the modulator RATE.

**Roland SYNTHESIZER MODEL SH-1**

# 44 SPACE SOUND

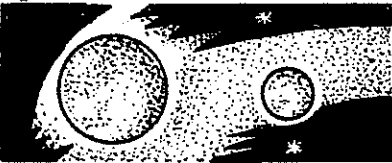

This sound is very much like the above sound except that it uses inverted ENV-1 control of the VCF so that the VCF pitch rises instead of falling. Since ENV-1 also controls the VCA, the sound becomes softer as it rises.

**Roland SYNTHESIZER MODEL SH-1**

# 45 SPACE RADIO

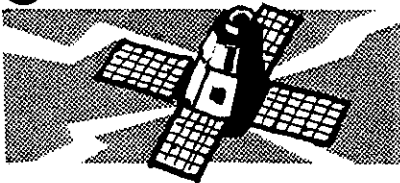

This sound uses the oscillating VCF. The modulator is set at RANDOM and controls the VCF frequency to produce random sounds. Try various positions of the controls. This sound works well with a reverb unit or echo chamber.

**Roland SYNTHESIZER MODEL SH-1**

# 46 RANDOM NOTES



With this setting, when a key is pressed, random notes are produced. Pressing different keys produces different tone colors. The VCO RANGE and WAVEFORM selectors, all the VCF sliders, and the ENV-1 sliders may be set anywhere. The rate at which the notes are produced is set by the

modulator RATE control; the pitch range of the notes by the VCO MOD control.

Roland  
SYNTHESIZER  
MODEL SH-1

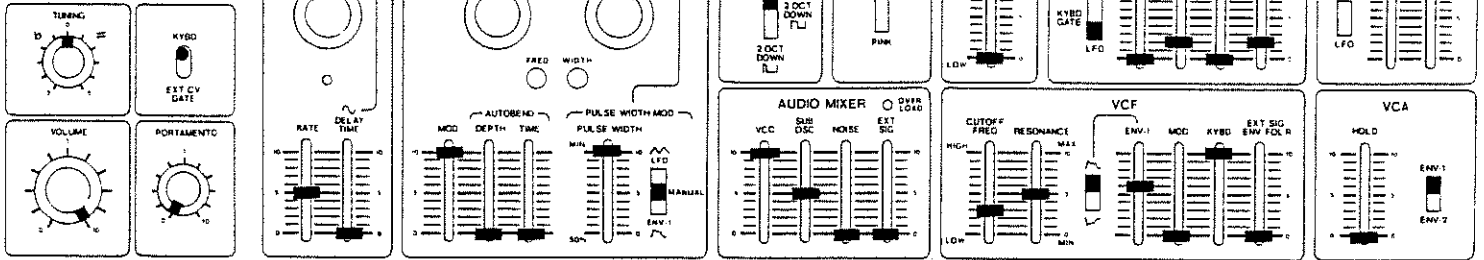

# 47 RANDOM FILTERED NOISE



This setting uses noise with the random note setting. Since noise is a combination of all pitches, it is possible to filter it to produce specific pitches using the VCF. With the VCF MOD slider raised, these pitches form random patterns. The use of the VCO in this setting gives the sound a metallic

quality; it is not particularly needed for random noise sounds.

Roland  
SYNTHESIZER  
MODEL SH-1

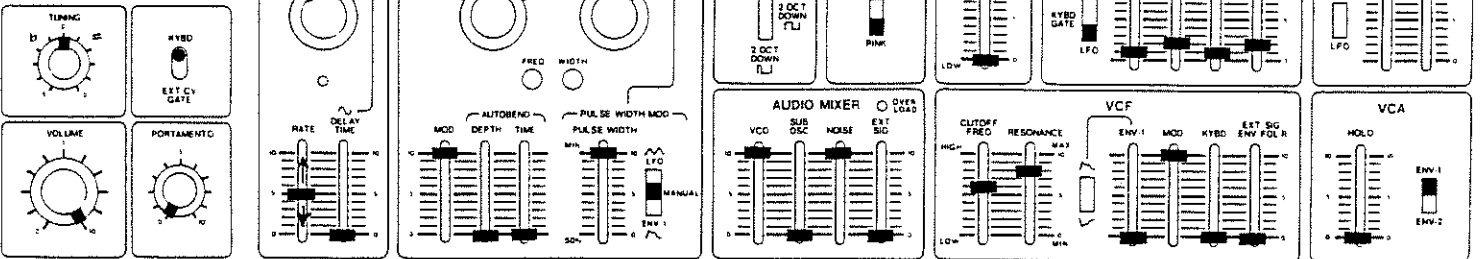

# 48 RANDOM DUET

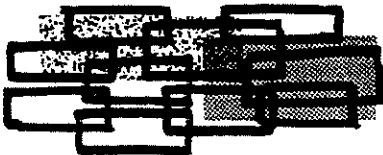

This sound uses two random sound sources: one is the VCO, the other is the oscillating VCF. Try different MOD settings for the VCO and VCF. Changing the VCF CUTOFF FREQ will produce large changes between metallic random notes to large sounding random notes. The sound will also depend

on which key is depressed.

Roland  
SYNTHESIZER  
MODEL SH-1

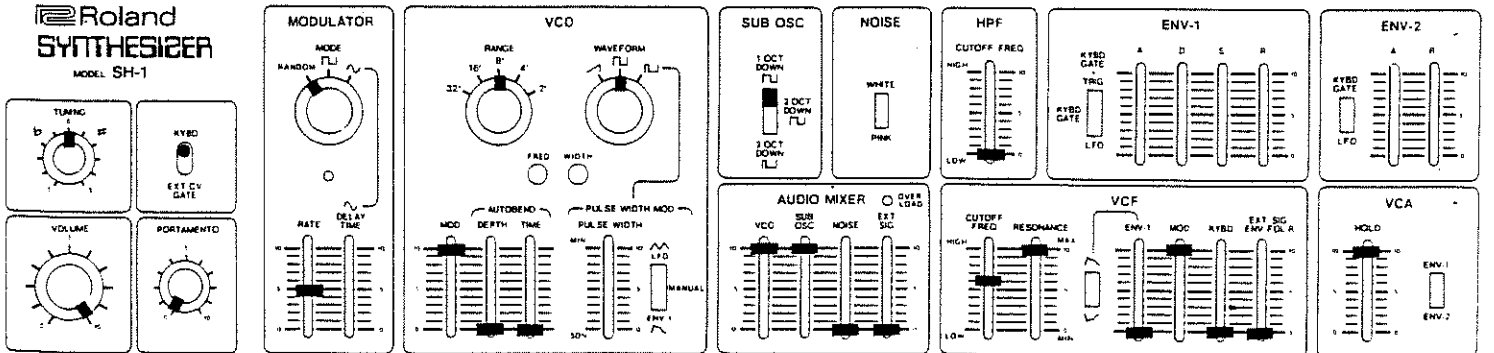

# 49 FUNKY GUITAR (ENVELOPE FOLLOWER)

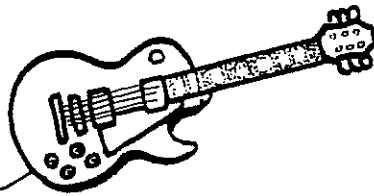

It is possible to create interesting changes in the tone color of electric guitars. Below is an example of an envelope follower setting for producing an automatic wah effect. For bass guitar, move the VCF CUTOFF FREQ control a little lower.

**Roland SYNTHESIZER MODEL SH-1**

Settings for 49 FUNKY GUITAR (ENVELOPE FOLLOWER):  
 MODULATOR: MODE (RANDOM), RATE (10), DELAY TIME (0).  
 VCO: RANGE (16), WAVEFORM (FU), FREQ (32), WIDTH (0).  
 SUB OSC: 1 OCT DOWN (FL), 2 OCT DOWN (FL).  
 NOISE: WHITE, PINK.  
 HPF: CUTOFF FREQ (10).  
 ENV-1: KYBD GATE (TRIG), LFO (0), A (10), D (10), S (10), R (10).  
 ENV-2: KYBD GATE (LFO), A (10), R (10).  
 AUDIO MIXER: VCO, SUB OSC, NOISE, EXT SIG, OVER LOUD.  
 VCF: CUTOFF FREQ (10), RESONANCE (10), ENV-1 (10), MOD (10), KYBD (10), EXT SIG (10), ENV FOL (R).  
 VCA: HOLD (10), ENV-1 (10), ENV-2 (10).

# 50 WAH-WAH GUITAR

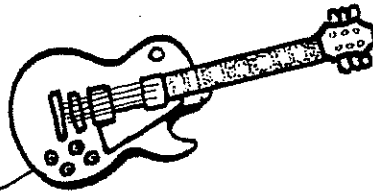

In this setting, the VCF is controlled by the modulator to produce "wah" sounds in the guitar. Experiment with the modulator RATE and VCF MOD controls. Electric pianos and string synthesizers can be used with this setting, too.

**Roland SYNTHESIZER MODEL SH-1**

Settings for 50 WAH-WAH GUITAR:  
 MODULATOR: MODE (RANDOM), RATE (10), DELAY TIME (0).  
 VCO: RANGE (16), WAVEFORM (FU), FREQ (32), WIDTH (0).  
 SUB OSC: 1 OCT DOWN (FL), 2 OCT DOWN (FL).  
 NOISE: WHITE, PINK.  
 HPF: CUTOFF FREQ (10).  
 ENV-1: KYBD GATE (TRIG), LFO (0), A (10), D (10), S (10), R (10).  
 ENV-2: KYBD GATE (LFO), A (10), R (10).  
 AUDIO MIXER: VCO, SUB OSC, NOISE, EXT SIG, OVER LOUD.  
 VCF: CUTOFF FREQ (10), RESONANCE (10), ENV-1 (10), MOD (10), KYBD (10), EXT SIG (10), ENV FOL (R).  
 VCA: HOLD (10), ENV-1 (10), ENV-2 (10).

# 51 RANDOM GUITAR

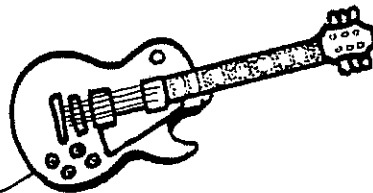

With the setting below, the RANDOM output of the modulator controls the VCF to produce random changes in the guitar tone color. Electric pianos and string synthesizers work well with this; set the VCF CUTOFF FREQ to match the instrument being used.

**Roland SYNTHESIZER MODEL SH-1**

Settings for 51 RANDOM GUITAR:  
 MODULATOR: MODE (RANDOM), RATE (10), DELAY TIME (0).  
 VCO: RANGE (16), WAVEFORM (FU), FREQ (32), WIDTH (0).  
 SUB OSC: 1 OCT DOWN (FL), 2 OCT DOWN (FL).  
 NOISE: WHITE, PINK.  
 HPF: CUTOFF FREQ (10).  
 ENV-1: KYBD GATE (TRIG), LFO (0), A (10), D (10), S (10), R (10).  
 ENV-2: KYBD GATE (LFO), A (10), R (10).  
 AUDIO MIXER: VCO, SUB OSC, NOISE, EXT SIG, OVER LOUD.  
 VCF: CUTOFF FREQ (10), RESONANCE (10), ENV-1 (10), MOD (10), KYBD (10), EXT SIG (10), ENV FOL (R).  
 VCA: HOLD (10), ENV-1 (10), ENV-2 (10).



# 52 VOICE SYNTHESIZER (ENVELOPE FOLLOWER)



Connecting a microphone to the SH-1 allows processing of any external sound source. With the level switch at "H", adjust the distance between the microphone and sound source so that the AUDIO MIXER OVERLOAD lamp lights only occasionally.

**Roland SYNTHESIZER MODEL SH-1**

**MODULATOR**: MODE (RANDOM), RATE, DELAY TIME

**VCO**: RANGE (16', 32', 48', 7'), WAVEFORM (FU, LU), FREQ, WIDTH, AUTOBEND (MOD, DEPTH, TIME), PULSE WIDTH MOD (MIN, MAX, LFO, MANUAL), ENV-1

**SUB OSC**: 1 OCT DOWN (FU), 2 OCT DOWN (FU), 3 OCT DOWN (FU)

**NOISE**: WHITE, PINK

**HPF**: CUTOFF FREQ (HIGH, LOW)

**ENV-1**: KYBD GATE (TRIG, LFO), A, D, S, R

**ENV-2**: KYBD GATE (LFO), A, R

**AUDIO MIXER**: VCO, SUB OSC, NOISE, EXT SIG, OVER LOAD

**VCF**: CUTOFF FREQ (HIGH, LOW), RESONANCE (MAX, MIN), ENV-1, MOD, KYBD, EXT SIG, ENV FOL R

**VCA**: HOLD, ENV-1, ENV-2

# 53 POLYPHONIC SYNTHESIZER

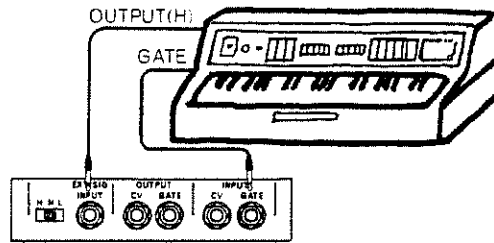

Connecting the RS-202 String Synthesizer GATE OUTPUT to the SH-1 GATE INPUT allows the RS-202 to trigger the SH-1 envelope generator. Set the CV/GATE selector switch at EXT CV/GATE. This setting allows the SH-1 to control the tone color of chords played on the RS-202.

**Roland SYNTHESIZER MODEL SH-1**

**MODULATOR**: MODE (RANDOM), RATE, DELAY TIME

**VCO**: RANGE (16', 32', 48', 7'), WAVEFORM (FU, LU), FREQ, WIDTH, AUTOBEND (MOD, DEPTH, TIME), PULSE WIDTH MOD (MIN, MAX, LFO, MANUAL), ENV-1

**SUB OSC**: 1 OCT DOWN (FU), 2 OCT DOWN (FU), 3 OCT DOWN (FU)

**NOISE**: WHITE, PINK

**HPF**: CUTOFF FREQ (HIGH, LOW)

**ENV-1**: KYBD GATE (TRIG, LFO), A, D, S, R

**ENV-2**: KYBD GATE (LFO), A, R

**AUDIO MIXER**: VCO, SUB OSC, NOISE, EXT SIG, OVER LOAD

**VCF**: CUTOFF FREQ (HIGH, LOW), RESONANCE (MAX, MIN), ENV-1, MOD, KYBD, EXT SIG, ENV FOL R

**VCA**: HOLD, ENV-1, ENV-2

# 54 AUTOMATIC FADE

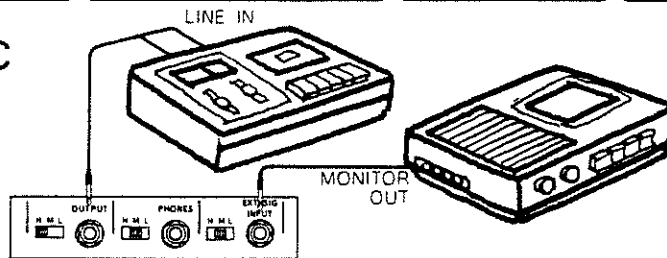

This setting allows automatic fades to be added when dubbing tapes. Hold a key down while dubbing; releasing the key will produce a fade-out, the rate of which depends on the ENV-2 "R" setting. The "A" control can be used for a fade-in. Monitor with headphones.

**Roland SYNTHESIZER MODEL SH-1**

**MODULATOR**: MODE (RANDOM), RATE, DELAY TIME

**VCO**: RANGE (16', 32', 48', 7'), WAVEFORM (FU, LU), FREQ, WIDTH, AUTOBEND (MOD, DEPTH, TIME), PULSE WIDTH MOD (MIN, MAX, LFO, MANUAL), ENV-1

**SUB OSC**: 1 OCT DOWN (FU), 2 OCT DOWN (FU), 3 OCT DOWN (FU)

**NOISE**: WHITE, PINK

**HPF**: CUTOFF FREQ (HIGH, LOW)

**ENV-1**: KYBD GATE (TRIG, LFO), A, D, S, R

**ENV-2**: KYBD GATE (LFO), A, R

**AUDIO MIXER**: VCO, SUB OSC, NOISE, EXT SIG, OVER LOAD

**VCF**: CUTOFF FREQ (HIGH, LOW), RESONANCE (MAX, MIN), ENV-1, MOD, KYBD, EXT SIG, ENV FOL R

**VCA**: HOLD, ENV-1, ENV-2

# SOUND SYNTHESIS MEMO

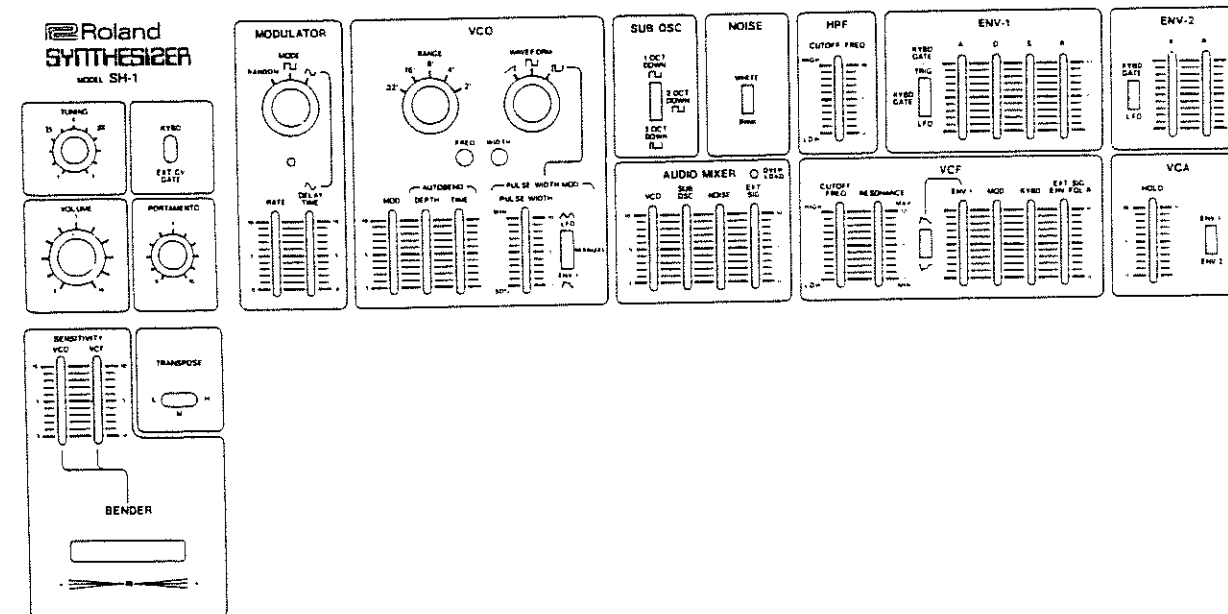
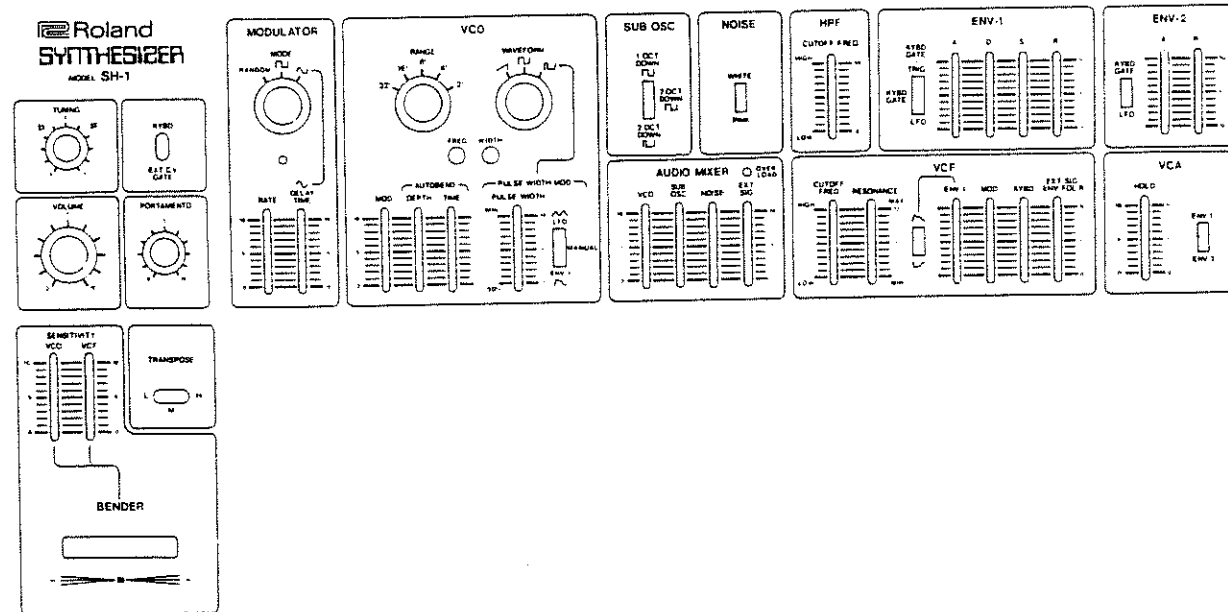
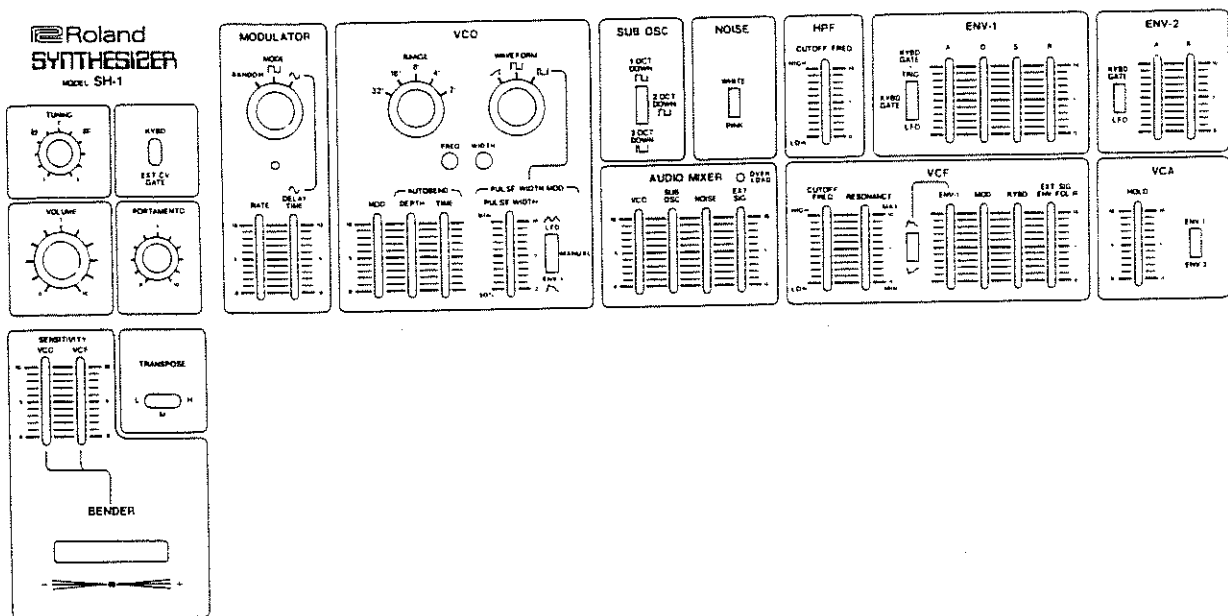

**Roland**  
**SYNTHESIZER**  
MODEL SH-1

TUNING: D, B, F  
HYBRID: HYBRID GATE, SET CV GATE

VOLUME: VOLUME  
PORTAMENTO: PORTAMENTO

**MODULATOR**  
MODE: RANDOM, FU  
RATE: RATE, RELAY TIME

**VCO**  
RANGE: R, B, F  
WAVEFORM: FU  
FREQUENCY: FREQ, WIDTH  
MODULATION: MOD, DEPTH, TIME  
PULSE WIDTH MOD: PULSE WIDTH, MOD, MANUAL

**SUB OSC**  
1 OCT DOWN  
2 OCT DOWN  
3 OCT DOWN

**NOISE**  
WHITE  
PINK

**HPF**  
CUTOFF FREQ: HIGH, LOW

**ENV-1**  
HYBRID GATE: HYBRID GATE, TRIG, LFO  
ENV: A, D, S, R

**ENV-2**  
HYBRID GATE: HYBRID GATE, TRIG, LFO  
ENV: A, R

**AUDIO MIXER**  
VCO, SUB OSC, NOISE, EXT SIG, OVER LOAD

**VCF**  
CUTOFF FREQ, RESONANCE, ENV 1, MOD, HYBRID, EXT SIG, ENV FOL A

**VCA**  
HOLD, ENV 1, ENV 2

SENSITIVITY: VCO, VCF  
TRANSPOSE: TRANSPOSE

**BENDER**

**Roland**  
**SYNTHESIZER**  
MODEL SH-1

TUNING: D, B, F  
HYBRID: HYBRID GATE, SET CV GATE

VOLUME: VOLUME  
PORTAMENTO: PORTAMENTO

**MODULATOR**  
MODE: RANDOM, FU  
RATE: RATE, RELAY TIME

**VCO**  
RANGE: R, B, F  
WAVEFORM: FU  
FREQUENCY: FREQ, WIDTH  
MODULATION: MOD, DEPTH, TIME  
PULSE WIDTH MOD: PULSE WIDTH, MOD, MANUAL

**SUB OSC**  
1 OCT DOWN  
2 OCT DOWN  
3 OCT DOWN

**NOISE**  
WHITE  
PINK

**HPF**  
CUTOFF FREQ: HIGH, LOW

**ENV-1**  
HYBRID GATE: HYBRID GATE, TRIG, LFO  
ENV: A, D, S, R

**ENV-2**  
HYBRID GATE: HYBRID GATE, TRIG, LFO  
ENV: A, R

**AUDIO MIXER**  
VCO, SUB OSC, NOISE, EXT SIG, OVER LOAD

**VCF**  
CUTOFF FREQ, RESONANCE, ENV 1, MOD, HYBRID, EXT SIG, ENV FOL A

**VCA**  
HOLD, ENV 1, ENV 2

SENSITIVITY: VCO, VCF  
TRANSPOSE: TRANSPOSE

**BENDER**

**Roland**  
**SYNTHESIZER**  
MODEL SH-1

TUNING: D, B, F  
HYBRID: HYBRID GATE, SET CV GATE

VOLUME: VOLUME  
PORTAMENTO: PORTAMENTO

**MODULATOR**  
MODE: RANDOM, FU  
RATE: RATE, RELAY TIME

**VCO**  
RANGE: R, B, F  
WAVEFORM: FU  
FREQUENCY: FREQ, WIDTH  
MODULATION: MOD, DEPTH, TIME  
PULSE WIDTH MOD: PULSE WIDTH, MOD, MANUAL

**SUB OSC**  
1 OCT DOWN  
2 OCT DOWN  
3 OCT DOWN

**NOISE**  
WHITE  
PINK

**HPF**  
CUTOFF FREQ: HIGH, LOW

**ENV-1**  
HYBRID GATE: HYBRID GATE, TRIG, LFO  
ENV: A, D, S, R

**ENV-2**  
HYBRID GATE: HYBRID GATE, TRIG, LFO  
ENV: A, R

**AUDIO MIXER**  
VCO, SUB OSC, NOISE, EXT SIG, OVER LOAD

**VCF**  
CUTOFF FREQ, RESONANCE, ENV 1, MOD, HYBRID, EXT SIG, ENV FOL A

**VCA**  
HOLD, ENV 1, ENV 2

SENSITIVITY: VCO, VCF  
TRANSPOSE: TRANSPOSE

**BENDER**

**Roland SYNTHESIZER**  
MODEL SH-1

TUNING: D, C, B, A, G, F, E, D

KYRO: ON, OFF

VOLUME: 0, 10, 20, 30, 40, 50, 60, 70, 80, 90, 100

PORTAMENTO: 0, 10, 20, 30, 40, 50, 60, 70, 80, 90, 100

SENSITIVITY VCO VCF: 1, 2, 3, 4, 5, 6, 7, 8, 9, 10

TRANPOSE: L, M, H

BENDER: - (down), + (up)

**MODULATOR**: MODE (RANDOM, FLU), RATE, DELAY TIME

**VCO**: RANGE (M, P, A, F), WAVEFORM (FLU), FREQ, WIDTH, AUTOBEND (MOD, DEPTH, TIME), PULSE WIDTH MOD (PULSE WIDTH, LFO, MANUAL)

**SUB OSC**: LOC1 DOWN (FLU), LOC2 DOWN (FLU)

**NOISE**: WHITE, PINK

**HPF**: CUTOFF FREQ (LFO, HIGH, LOW)

**ENV-1**: KYRO GATE (LFO), A, D, S, R

**ENV-2**: KYRO GATE (LFO), A, R

**AUDIO MIXER**: VCO, SUB OSC, NOISE, EST SIG, EST SIG

**VCF**: CUTOFF FREQ, RESONANCE, ENV-1, ENV-2, MOD, KYRO, EST SIG, ENV FOL R

**VCA**: HOLD, ENV-1, ENV-2

**Roland SYNTHESIZER**  
MODEL SH-1

TUNING: D, C, B, A, G, F, E, D

KYRO: ON, OFF

VOLUME: 0, 10, 20, 30, 40, 50, 60, 70, 80, 90, 100

PORTAMENTO: 0, 10, 20, 30, 40, 50, 60, 70, 80, 90, 100

SENSITIVITY VCO VCF: 1, 2, 3, 4, 5, 6, 7, 8, 9, 10

TRANPOSE: L, M, H

BENDER: - (down), + (up)

**MODULATOR**: MODE (RANDOM, FLU), RATE, DELAY TIME

**VCO**: RANGE (M, P, A, F), WAVEFORM (FLU), FREQ, WIDTH, AUTOBEND (MOD, DEPTH, TIME), PULSE WIDTH MOD (PULSE WIDTH, LFO, MANUAL)

**SUB OSC**: LOC1 DOWN (FLU), LOC2 DOWN (FLU)

**NOISE**: WHITE, PINK

**HPF**: CUTOFF FREQ (LFO, HIGH, LOW)

**ENV-1**: KYRO GATE (LFO), A, D, S, R

**ENV-2**: KYRO GATE (LFO), A, R

**AUDIO MIXER**: VCO, SUB OSC, NOISE, EST SIG, EST SIG

**VCF**: CUTOFF FREQ, RESONANCE, ENV-1, ENV-2, MOD, KYRO, EST SIG, ENV FOL R

**VCA**: HOLD, ENV-1, ENV-2

**Roland SYNTHESIZER**  
MODEL SH-1

TUNING: D, C, B, A, G, F, E, D

KYRO: ON, OFF

VOLUME: 0, 10, 20, 30, 40, 50, 60, 70, 80, 90, 100

PORTAMENTO: 0, 10, 20, 30, 40, 50, 60, 70, 80, 90, 100

SENSITIVITY VCO VCF: 1, 2, 3, 4, 5, 6, 7, 8, 9, 10

TRANPOSE: L, M, H

BENDER: - (down), + (up)

**MODULATOR**: MODE (RANDOM, FLU), RATE, DELAY TIME

**VCO**: RANGE (M, P, A, F), WAVEFORM (FLU), FREQ, WIDTH, AUTOBEND (MOD, DEPTH, TIME), PULSE WIDTH MOD (PULSE WIDTH, LFO, MANUAL)

**SUB OSC**: LOC1 DOWN (FLU), LOC2 DOWN (FLU)

**NOISE**: WHITE, PINK

**HPF**: CUTOFF FREQ (LFO, HIGH, LOW)

**ENV-1**: KYRO GATE (LFO), A, D, S, R

**ENV-2**: KYRO GATE (LFO), A, R

**AUDIO MIXER**: VCO, SUB OSC, NOISE, EST SIG, EST SIG

**VCF**: CUTOFF FREQ, RESONANCE, ENV-1, ENV-2, MOD, KYRO, EST SIG, ENV FOL R

**VCA**: HOLD, ENV-1, ENV-2

**Roland**  
**SYNTHESIZER**  
MODEL SH-1

TUNING: HI, SE, LO

HYBRID EST. CV GATE

VOLUME

PORTAMENTO

SENSITIVITY VCO VCF

TRANSPOSE: L, M, H

BENDER

**MODULATOR**

MODE: RANDOM, FL, S

**VCO**

RANGE: 32, 16, 8, 4, 2

WAVEFORM: FL, S

FREQ. WIDTH

AUTOMOD: MOD, DEPTH, TIME

PULSE WIDTH MOD: PULSE WIDTH, LFO

**SUB OSC**

1 OCT DOWN, FL, 2 OCT DOWN, FL

**NOISE**

WHITE, PPK

**HPF**

CUTOFF FREQ.

**ENV-1**

HYBRID GATE, TRIG, LFO

A, D, S, R

**ENV-2**

HYBRID GATE, TRIG, LFO

A, R

**AUDIO MIXER**

VCO, SUB OSC, NOISE, EST. CV

**VCF**

CUTOFF FREQ., RESONANCE, MAX

ENV-1, MOD, HYBRID, EST. CV, ENV FOL. R

**VCA**

HOLD

ENV-1, ENV-2

**Roland**  
**SYNTHESIZER**  
MODEL SH-1

TUNING: HI, SE, LO

HYBRID EST. CV GATE

VOLUME

PORTAMENTO

SENSITIVITY VCO VCF

TRANSPOSE: L, M, H

BENDER

**MODULATOR**

MODE: RANDOM, FL, S

**VCO**

RANGE: 32, 16, 8, 4, 2

WAVEFORM: FL, S

FREQ. WIDTH

AUTOMOD: MOD, DEPTH, TIME

PULSE WIDTH MOD: PULSE WIDTH, LFO

**SUB OSC**

1 OCT DOWN, FL, 2 OCT DOWN, FL

**NOISE**

WHITE, PPK

**HPF**

CUTOFF FREQ.

**ENV-1**

HYBRID GATE, TRIG, LFO

A, D, S, R

**ENV-2**

HYBRID GATE, TRIG, LFO

A, R

**AUDIO MIXER**

VCO, SUB OSC, NOISE, EST. CV

**VCF**

CUTOFF FREQ., RESONANCE, MAX

ENV-1, MOD, HYBRID, EST. CV, ENV FOL. R

**VCA**

HOLD

ENV-1, ENV-2

**Roland**  
**SYNTHESIZER**  
MODEL SH-1

TUNING: HI, SE, LO

HYBRID EST. CV GATE

VOLUME

PORTAMENTO

SENSITIVITY VCO VCF

TRANSPOSE: L, M, H

BENDER

**MODULATOR**

MODE: RANDOM, FL, S

**VCO**

RANGE: 32, 16, 8, 4, 2

WAVEFORM: FL, S

FREQ. WIDTH

AUTOMOD: MOD, DEPTH, TIME

PULSE WIDTH MOD: PULSE WIDTH, LFO

**SUB OSC**

1 OCT DOWN, FL, 2 OCT DOWN, FL

**NOISE**

WHITE, PPK

**HPF**

CUTOFF FREQ.

**ENV-1**

HYBRID GATE, TRIG, LFO

A, D, S, R

**ENV-2**

HYBRID GATE, TRIG, LFO

A, R

**AUDIO MIXER**

VCO, SUB OSC, NOISE, EST. CV

**VCF**

CUTOFF FREQ., RESONANCE, MAX

ENV-1, MOD, HYBRID, EST. CV, ENV FOL. R

**VCA**







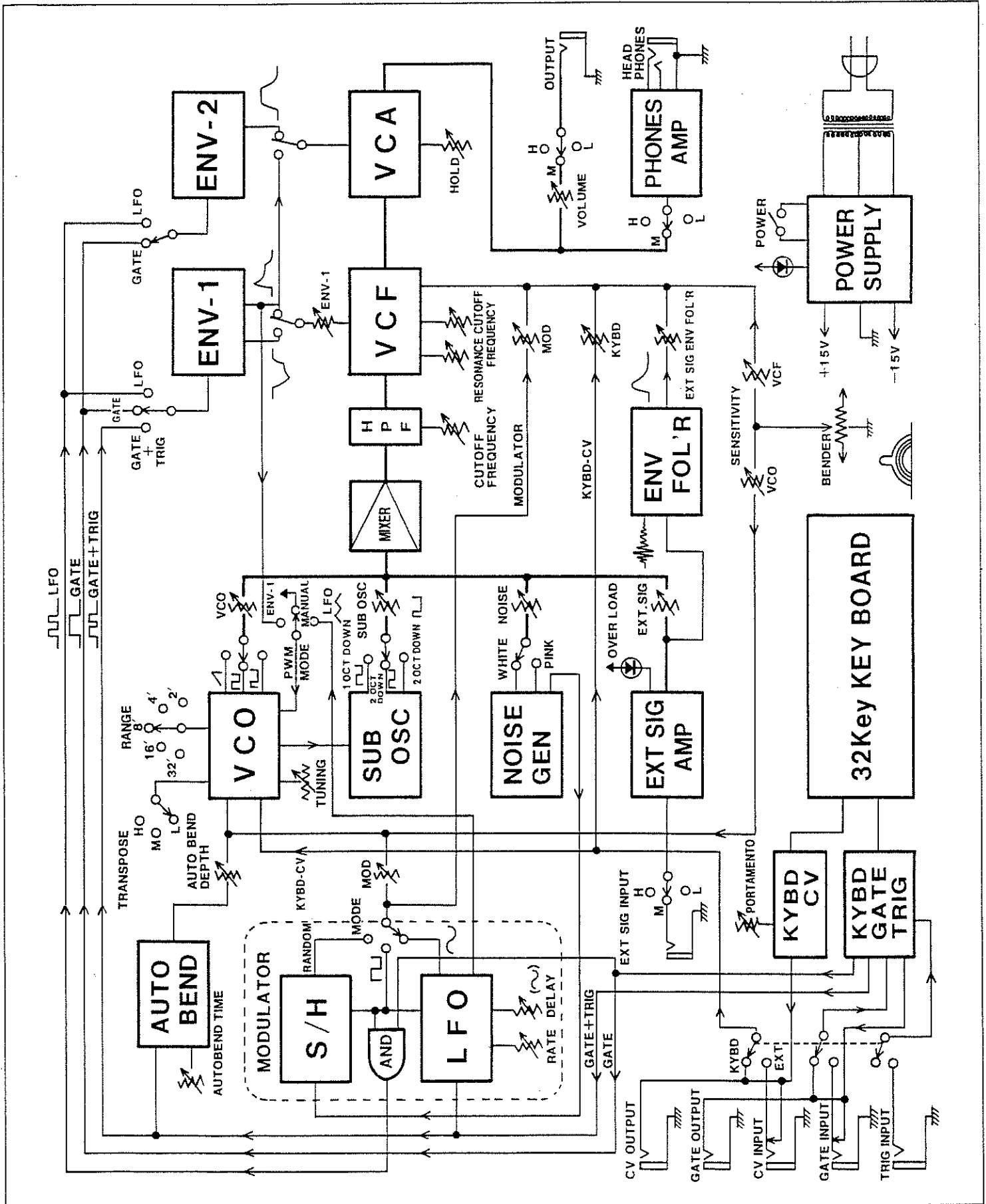

HOLD

ENV-1, ENV-2

# BLOCK DIAGRAM



# SPECIFICATIONS

- **KEYBOARD** . . . 32 keys, 2-1/2 octaves
  - **VCO (Voltage Controlled Oscillator)**
    - Modulator
    - Autobend Depth
    - Autobend Time (8msec-360msec)
    - VCO Range (32', 16' 8', 4', 2')
    - Waveform (, , )
    - Pulsewidth Modulation (Min-50%)
    - PWM Mode Switch  
(Env-1/Manual/LFO)
  - **SUB OSC (Sub-oscillator)**
    - 1 OCT DOWN  / 2 OCT DOWN  / 2 OCT DOWN 
  - **NOISE GENERATOR**
    - White/Pink Selector
  - **AUDIO MIXER**
    - VCO/SUB OSC/NOISE/EXT SIG
    - Overload Indicator
  - **HPF (High Pass Filter)**
    - Cutoff Frequency Control (25Hz-5KHz)
  - **VCF (Voltage Controlled Filter)**
    - Cutoff Frequency Control (5Hz-20KHz)
    - Resonance (Min-Self Oscillation)
    - ENV-1 Polarity Switch ()
    - ENV-1 Control
    - MOD Control
    - KYBD Control
    - EXT SIG ENV FOL'R Control
  - **VCA (Voltage Controlled Amplifier)**
    - Hold Control
    - Envelope Switch (ENV-1/ENV-2)
  - **ENVELOPE GENERATOR**
    - ENV-1
      - Attack Time (1.5msec-2.5sec)
      - Decay Time (1.5msec-8sec)
      - Sustain Level (0-100%)
      - Release Time (1.5msec-8sec)
      - Gate Trigger Selector Switch  
(Gate+Trig/Gate/LFO)
    - ENV-2
      - Attack Time (1.5msec-3sec)
      - Release Time (1.5msec-8sec)
      - Gate Selector Switch (Gate/LFO)
  - **MODULATOR**
    - Modulation Mode Switch  
(Random//)
    - Rate (0.2Hz-25Hz)
    - Delay Time (0-3sec)
    - Rate Indicator
  - **KYBD/EXT CV GATE SWITCH**
  - **TUNING (±700 cents)**
  - **PORTAMENTO (0-2.5sec)**
  - **VOLUME**
  - **TRANSPOSE SWITCH (L/M/H)**
  - **BENDER**
    - Bender Lever
    - Bender Sensitivity (VCO, VCF)
  - **POWER SWITCH**
    - Power Indicator
  - **CONNECTION JACKS**
    - Output Jack
    - Output Level Switch (L/M/H)  
(standard -20dBm/-8dBm/+4dBm)
    - Phones Jack (8Ω, stereo)
    - Phones Output Level Switch (L/M/H)
    - External Signal Jack
    - External Signal Level Switch (L/M/H)  
(standard 0dBm/-20dBm/-40dBm)
    - External Control Voltage Input Jack  
(1V/oct)
    - External Gate Voltage Input Jack  
(ON with +7.5V or over)
    - Keyboard Control Voltage Output Jack  
(1V/oct)
    - Keyboard Gate Output Jack  
(OFF - 0V, ON - +14V)
  - **GENERAL**
    - Power Consumption . . . . . 10W
    - Dimensions . . . . . 610(W) x 370(D) x 135(H)mm  
24(W) x 14.6(D) x 5.3(H)in
    - Weight . . . . . 6.4kg, 14.1 lbs
    - Accessory . . . . . 2.5m connection cord
- \* Specifications are subject to change without notice.

 Roland®

10244

UPC 10244



10981