

Roland

VOCODER SVC-350

OWNER'S MANUAL

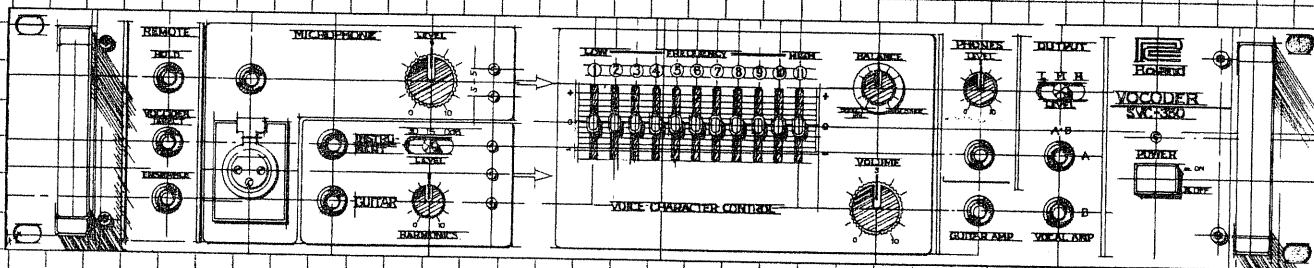

VOCODER

The SVC-350 is a rack mount type vocoder designed to accept external inputs. It is easy to use both in the studio and on the stage.

FEATURES

- Clear, high quality vocoder sound.
- The vocoder produces sound whose expression follows the expression of the input voice.
- Includes unique voice character controls.
- With the specially designed chorus circuit, a solo voice input can become a large chorus.
- Special hold circuit will hold the vocoder tone quality by means of an external foot switch.
- Two separate inputs allow simultaneous use of an electric guitar and a keyboard instrument such as a synthesizer, strings, etc.
- To enrich the guitar sound, a special compressor and a harmonic control circuit are included in the guitar input.
- Two separate output jacks, one for a vocal amplifier and the other for a guitar amplifier.
- Includes a headphone monitoring circuit.

BEFORE OPERATING

- Check with your local Roland dealer if you want to use the SVC-350 in a foreign country.
- Plug the SVC-350 in before turning on the power switch.

PRECAUTIONS

- Do not open this unit.
- Unplug this unit when it is not to be used for long periods of time. Unplug by grasping the plug rather than pulling on the cord.
- Be careful not to place heavy objects on the power cord.
- Avoid using this unit in very high or low temperature locations. Also keep it away from heaters and air-conditioners since this type of equipment will affect circuit and pitch stability.
- Avoid using this unit in very dusty or humid places.
- If it is necessary to use this unit in an area with neon or fluorescent lights, keep it as far away from these lights as possible since they will induce high levels of noise. Sometimes changing the angle of this unit in relation to the lights will help reduce noise.
- When connecting this unit, plug the cord into the external amplifier first, then plug the other end of the cord into the SVC-350 output. To disconnect, remove the cord from the SVC-350 first, then from the amplifier.
- To clean this unit, wipe with a cloth dampened with a neutral cleanser. Do not use solvents such as paint thinner.

CONNECTIONS

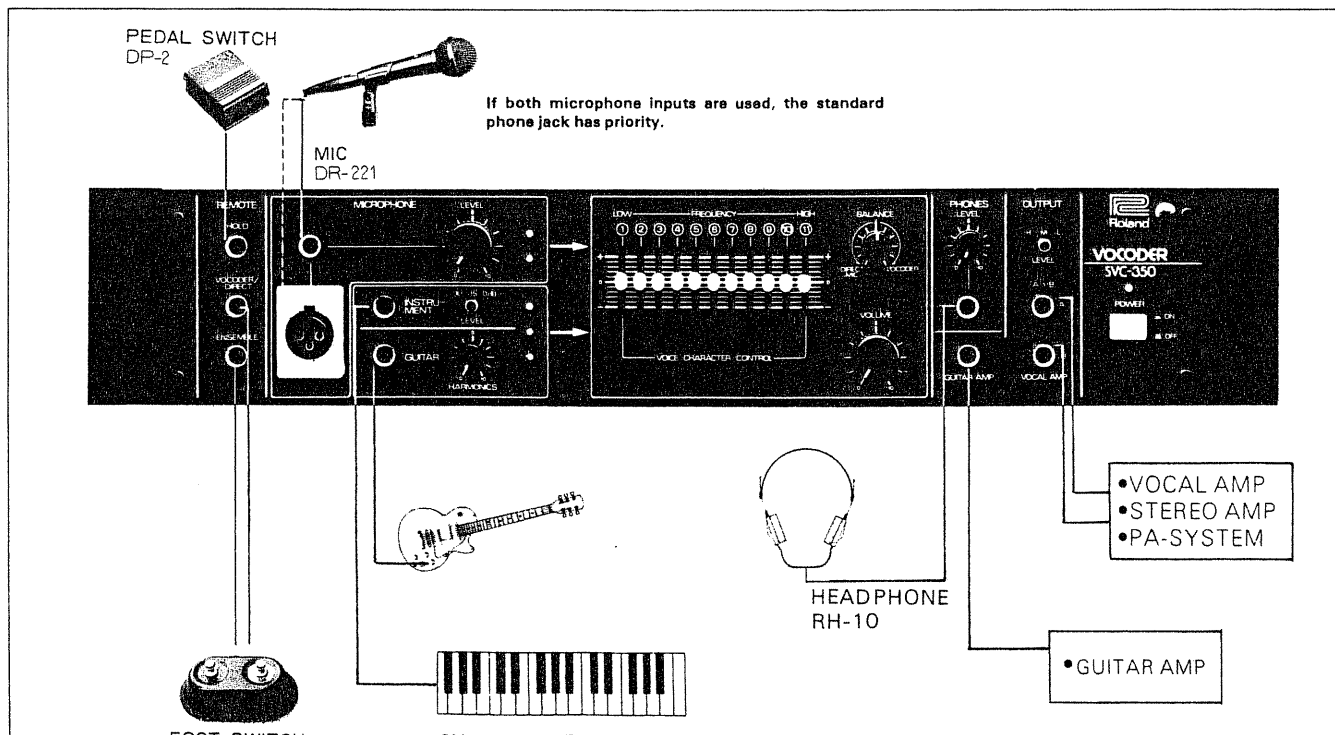

OPERATION

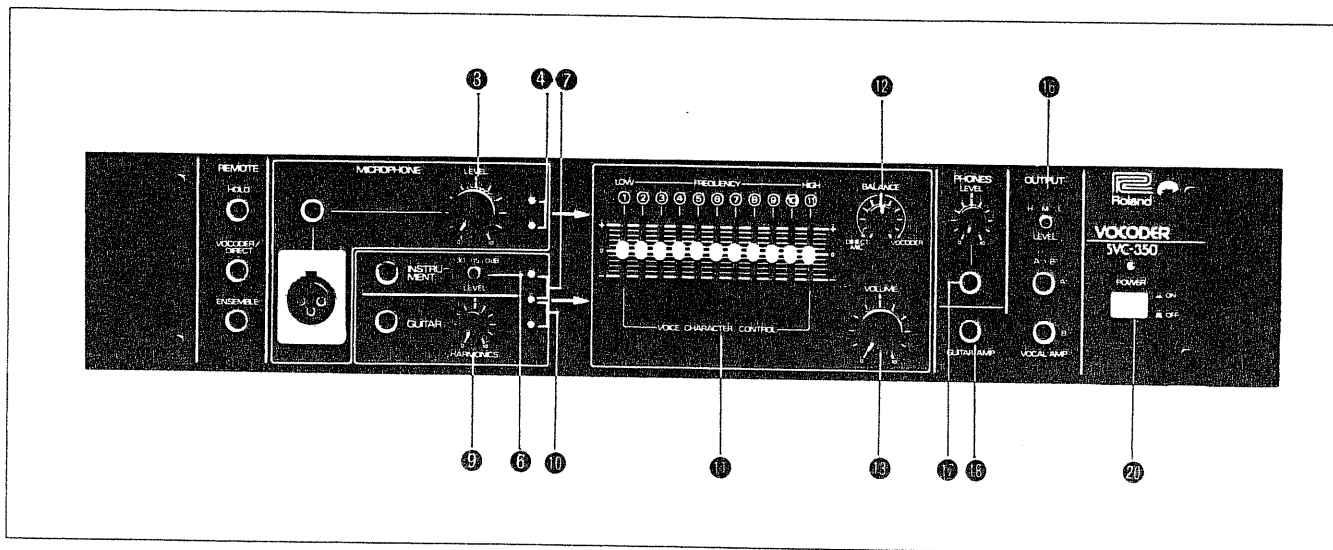

1. After making the connections shown in the drawing, set the controls as shown above and turn on the POWER switch 20 .

2. Adjusting the input levels:

(1). Microphone level

Set the MICROPHONE LEVEL control 3 so that the green indicator 4 lights and so that the red indicator 5 does not light even with loud passages.

(2). Instrument level

Set the INPUT LEVEL switch 6 so as to match the level of the instrument being used. Set the output level of the instrument so that only the green indicator 7 lights when the instrument is played.

(3). Guitar level

Adjust the output level of the guitar so that the indicator 10 lights.

- The GUITAR and INSTRUMENT inputs can be used simultaneously, in which case both instruments should be played at the same time while adjusting their outputs so that the red indicator does not light.

Once the input levels have been set, they should not be changed.

3. Adjusting the output level:

(1). Set the BALANCE control 12 at DIRECT MIC and the VOLUME control 14 between 5 and 7.

(2). Speak or sing into the microphone. Set the OUTPUT LEVEL switch 15 (when using VOCAL AMP OUTPUTS 17 18 only) and the external amplifier volume control for the desired sound level.

4. Try producing the vocoder sound:

(1). Set the BALANCE control 12 at VOCODER and try playing the input instrument. In this condition, no sound is produced.

(2). Try speaking or singing into the microphone while playing the input instrument. The vocoder will produce the sound of your voice using the tone color of the input instrument sound.

5. Set the VOICE CHARACTER 11 (p.4) and HARMONICS 9 (p.4) controls for the desired sound quality.

6. The output level of the vocoder sound is determined by the OUTPUT VOLUME control 15 and by the volume control of the external amplifier being used. When operating in the DIRECT mode, the SVC-350 has no direct control over the output volume. (Adjust using the volume control of the external amplifier).

NAMES AND FUNCTIONS OF THE CONTROLS

INPUT SECTION

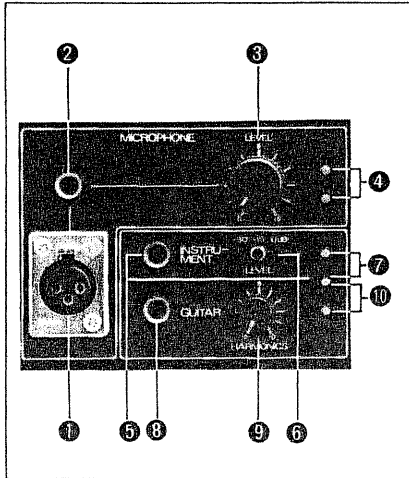

MICROPHONE INPUTS ① ②

If both inputs are used at the same time, the phone jack input ② will have priority.

For vocoder inputs, dynamic microphones will usually work better than condenser microphones.

INSTRUMENT Jack ④

For instruments other than guitar. This input is the source of material (sound) from which the vocoder sound is made; therefore, the instrument used should produce a clear sound which is rich in harmonic. Do not use peculiar sounds or sounds with a long attack time.

When using a synthesizer, set as follows:

VCO: Use sawtooth wave, or a pulse wave with a short duty cycle (minimum).

VCF: Set the cutoff frequency high.

ENV: Set ATTACK = 0; SUSTAIN = 10 (maximum); RELEASE = 2 or 3 (DECAY is not used).

When using a string synthesizer, set the ENSEMBLE effect at OFF.

If the input instrument has a wide dynamic range, it may prove better to use the GUITAR INPUT jack ⑦ to take advantage of the compressor used in this circuit.

INSTRUMENT LEVEL Switch ⑤

Set to match the input instrument being used.

● Fine adjustment should be made using the output level control of the instrument.

INSTRUMENT LEVEL INDICATOR ⑥

GUITAR INPUT Jack ⑦

Use the guitar output level to adjust the input level to the vocoder.

HARMONICS Control ⑧

This controls the harmonics contained in the guitar sound. Turning clockwise brightens the sound.

● Be careful not to turn this control too high because unwanted harmonics can be produced when playing chords.

GUITAR INPUT INDICATOR ⑩

The red indicator lights when the combined instrument and guitar input levels are too high. If the red indicator lights, turn down the output level of either or both of the input instruments.

VOCODER SECTION

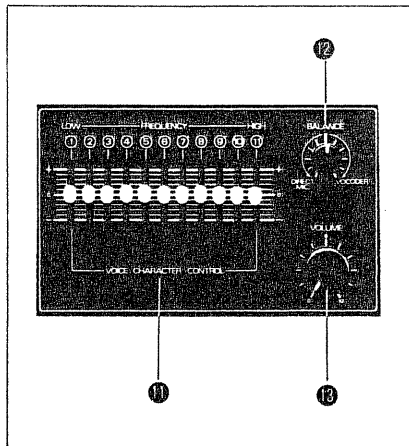

VOICE CHARACTER Controls ⑪

These controls can be used to alter the tone quality of the vocoder sounds for creative work or to help compensate for a speaker deficiency.

BALANCE Control ⑬

Controls the balance between the vocoder sound and the direct sound from the microphone input. Fully clockwise produces the vocoder sound only; fully counterclockwise produces the microphone sound, and setting to the center produces mixture of both.

VOLUME Control ⑫

The output level of the sound produced by the instrument or guitar when in the DIRECT mode is determined by the instrument's output level setting and the external amplifier's volume control. For this reason, when using a foot switch to change between DIRECT and VOCODER modes, this VOLUME control ⑫ is needed to balance the vocoder sound with the DIRECT mode sound.

PHONES AND OUTPUT SECTIONS

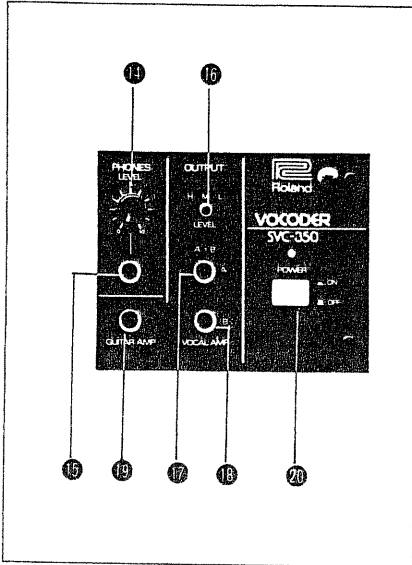

HEADPHONE LEVEL Control 14

HEADPHONE Jack 15

OUTPUT LEVEL SELECTOR Switch 16
Affects only the VOCAL AMP OUTPUTS 17 18

VOCAL AMP OUTPUT Jacks 17 18

GUITAR AMP OUTPUT Jack 19

POWER Switch 20 with pilot.

REMOTE CONTROL SECTION

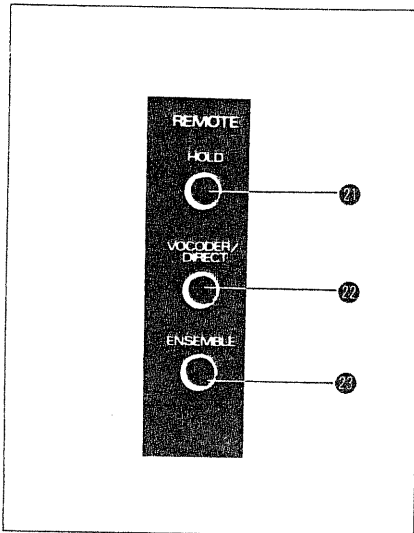

HOLD Jack 21

For using a pedal switch (Roland DP-2; sold separately) to hold the vocoder tone color. When the pedal is depressed, the voice tone color being produced at that point will be held until the pedal is released. This can be used to bridge gaps where the singer takes a breath, as one example of use.

VOCODER/DIRECT Jack 22

For using a foot switch (Roland FS-2) to switch between the vocoder sound and the direct sound of the microphone.

•With no connection to this jack, the VOCODER mode sound is produced.

ENSEMBLE Jack 23

For remote ON/OFF control of the vocoder ensemble sound by means of a foot switch (Roland FS-2).

•With no connection to this jack, the vocoder is in the ENSEMBLE mode.

REAR PANEL

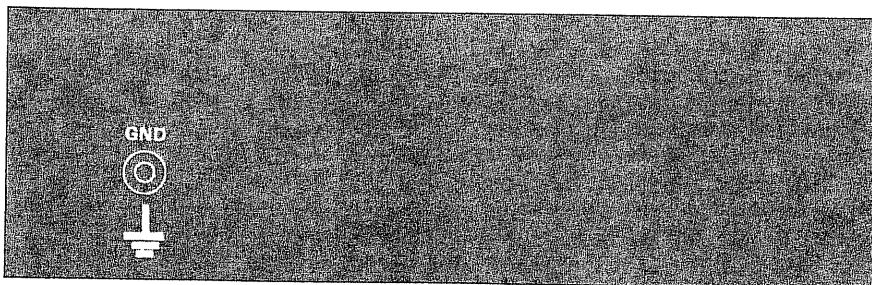

GND (ground)

For making common ground connections with other equipment.

OUTPUT CONNECTIONS

•USING VOCAL AMP ONLY

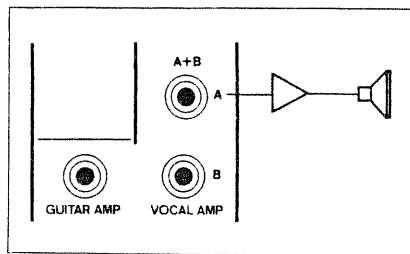

VOCAL AMP
MONO OUT

VOCODER MODE	VOCODER DIRECT - MICROPHONE
DIRECT MODE	INSTRUMENT - GUITAR DIRECT - MICROPHONE

•USING VOCAL AMP (2ch) ONLY

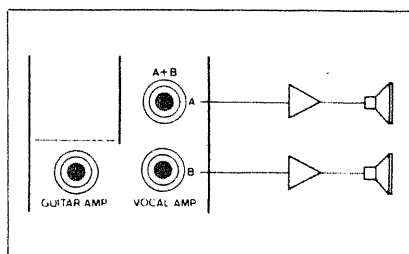

VOCAL AMP
STEREO OUT

VOCODER MODE	VOCODER DIRECT - MICROPHONE
DIRECT MODE	INSTRUMENT - GUITAR DIRECT - MICROPHONE

•USING GUITAR AMP ONLY

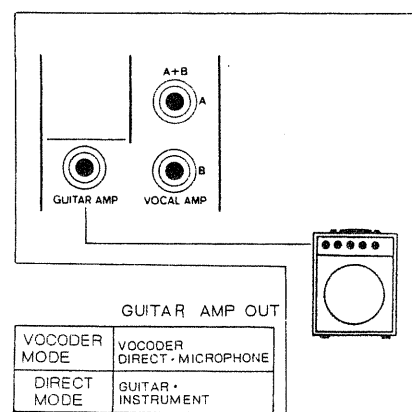

GUITAR AMP OUT

VOCODER MODE	VOCODER DIRECT - MICROPHONE
DIRECT MODE	GUITAR - INSTRUMENT

•USING VOCAL AMP AND GUITAR AMP

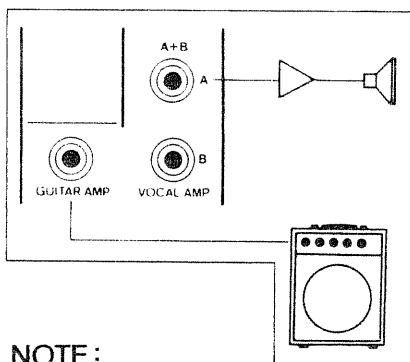

NOTE :

With no connection to the VOCODER/DIRECT jack, the vocoder will remain in the VOCODER MODE.

•USING VOCAL AMP (2ch) AND GUITAR AMP

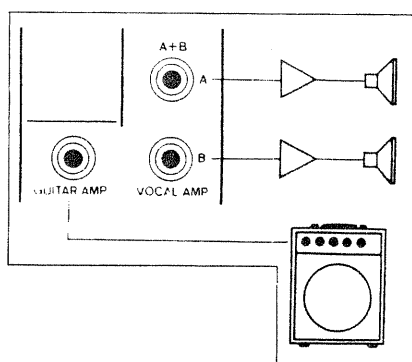

In the two drawings at the left, the vocoder and/or direct microphone sounds do not appear at the GUITAR OUTPUT jack 19.

VOCAL AMP
(MONO/STEREO) OUT

VOCODER MODE	VOCODER DIRECT - MICROPHONE	X
DIRECT MODE	DIRECT - MICROPHONE	INSTRUMENT - GUITAR

About the Vocoder

In 1939, H. Dudley announced a band width compression device for use in telecommunication systems. The present day vocoder is based on the principles of this device.

The vocoder requires two inputs: the carrier input and the program input.

The program input often consists of spoken or sung words which are input through a microphone. The carrier usually consists of an instrument input such as a synthesizer.

The vocoder circuits consist of two major sections: the analyzing section and the synthesizing section. The analyzing section breaks down the program (or voice) input to determine its frequency content at any given instant, then re-assembles this sound in the synthesizer section using the carrier (or instrument) input as a basic source of building material. In this way the carrier or instrument input is continuously processed so that it seems to speak or sing the words which appear at the program input. The pitch of this sound will be determined by the pitch of the carrier input.

The program or voice input is analyzed by passing it through a set of filters to determine what the harmonic content of the sound is and how it changes as the sound progresses. For example, the sound "oo" usually consists of primarily

low frequencies while the sound "ee" usually consists of higher frequencies. The result of this analysis is a group of control voltages which are used to control the synthesizer portion of the vocoder. Each of these control voltages controls the output level of a second series of filters. This second series of filters operate on the carrier input signal. With the sound "ee", then, the control voltages which represent higher frequencies will be at a higher level than those control voltages representing lower frequencies thus opening partially or completely those synthesizer section filters associated with the higher frequencies. By this means, the original voice sound is reconstructed using the tone color material from the carrier input. The sound of the instrument used as the carrier input will seem to "speak" or "pronounce" the "ee" sound.

Using the Vocoder

Since the vocoder produces sound by analyzing the microphone input and using this analysis to reconstruct the sound from the carrier input, it becomes obvious that the vocoder cannot produce sound if either of the two inputs is missing. This means that it becomes very important for the words spoken or sung into the microphone to be well synchronized with the notes or phrases played on the input instrument.

Since the pitch of the vocoder output is determined by the instrument input rather than the voice input, it is possible to use pitch related effects such as vibrate and pitch bend to enhance the sound.

If the vocoder output sound is combined with the direct sound (BALANCE control 18 near center), it is possible to produce duet effects by singing pitches which are different from those being played on the input instrument.

BLOCK DIAGRAM

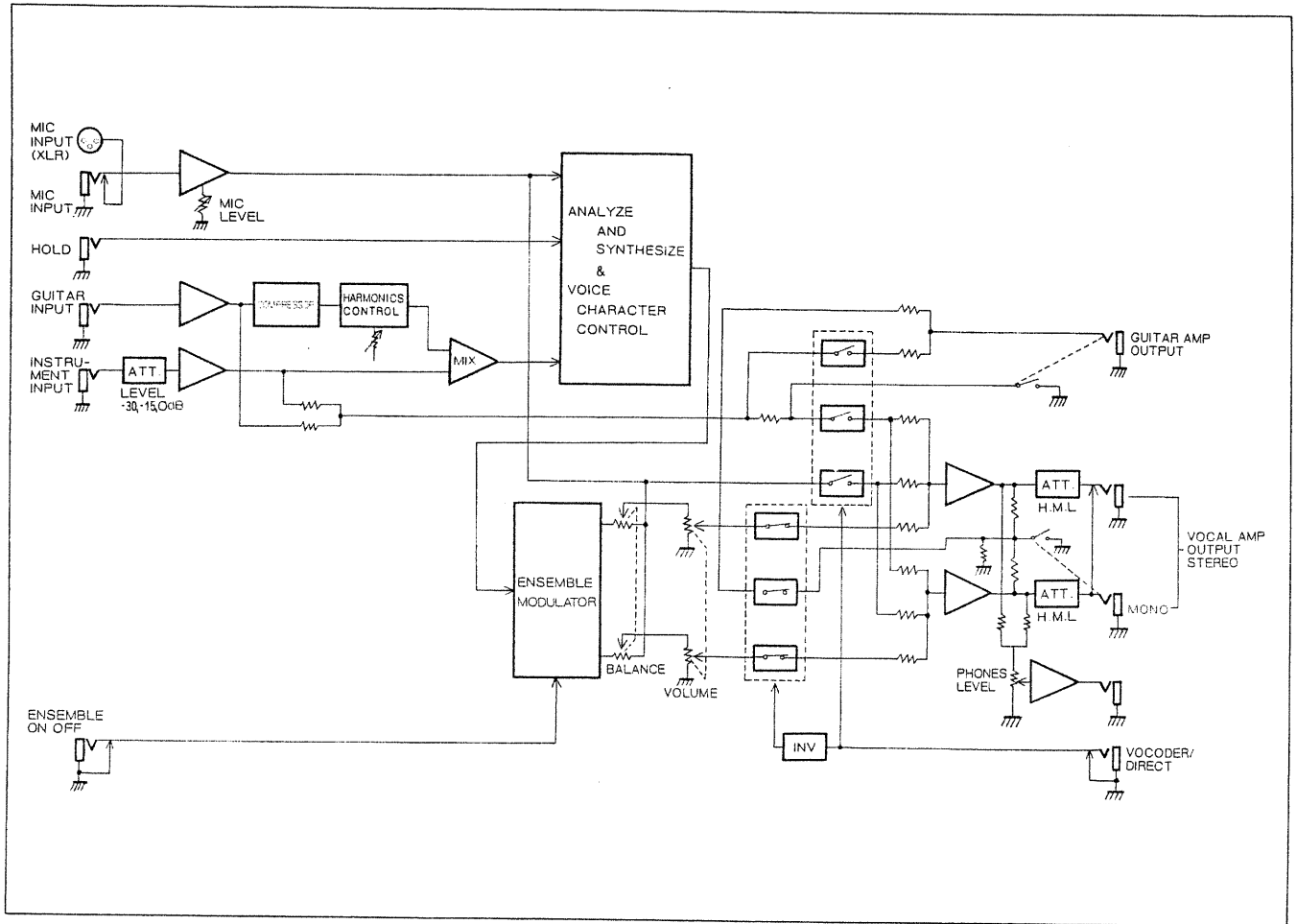

● Rack Mounting the SVC-350

the SVC-350 can be mounted in a standard 19" rack using 5mm screws as shown in the drawing.

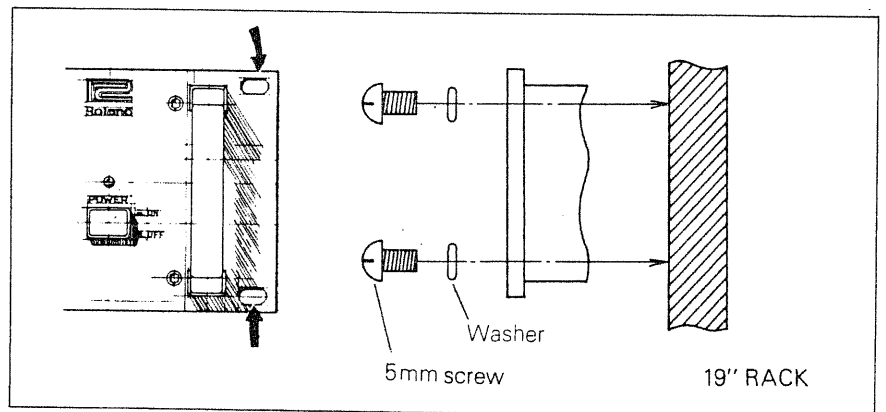

SPECIFICATIONS

ROLAND VOCODER Model SVC-350

INPUTS

MIC INPUT: 1/4 inch STANDARD Phone Jack or EIA-RS297 Connector (600Ω, -54dBm min.)

INSTRUMENT INPUT: 1/4 inch STANDARD Phone Jack (100kΩ, 0 dB max.)

GUITAR INPUT: 1/4 inch STANDARD Phone Jack (100kΩ, GUITAR Low LEVEL)

INSTRUMENT LEVEL SELECTOR Switch (0dBm, -15dBm, -30dBm)

INPUT LEVEL INDICATORS:

LED DISPLAY.....5

MIC LEVEL; Green, Red/over

INSTRUMENT LEVEL; Green Red/over

GUITAR LEVEL; Green Red/over

OUTPUTS

For GUITAR AMPLIFIER: 1/4 inch STANDARD Phone Jack (5kΩ)

MONO or STEREO OUTPUTS: 1/4 inch STANDARD Phone Jack

MONO or STEREO OUTPUT LEVEL SELECTOR Switch (H, M, L)

PHONES OUTPUT: 1/4 inch Stereo Phone Jack

CONTROLS

MIC LEVEL CONTROL (-54dB to -14dB)

GUITAR HARMONICS CONTROL

11 ELEMENT VOICE CHARACTER CONTROL

VOCODER VOLUME CONTROL

VOCODER/DIRECT MIC BALANCE CONTROL

ENSEMBLE ON/OFF: 1/4 inch STANDARD Phone Jack for PEDAL Switch

DIRECT/VOCODER: 1/4 inch STANDARD Phone Jack for PEDAL Switch

HOLD ON/OFF: 1/4 inch STANDARD Phone Jack for PEDAL Switch

PHONES VOLUME CONTROL

MECHANICAL DETAILS

2U EIA STANDARD RACK MOUNT TYPE

POWER Switch/INDICATOR

POWER CONSUMPTION: 8W

DIMENSIONS: 482(W) x 92(H) x 350(D)mm
19(W) x 3⁵/₈(H) x 13³/₁₆(D)in.

WEIGHT: 14kg / 30lb. 14oz.

Accessories: Foot Switch FS-2

Specifications are subject to change without notice

OPTIONS

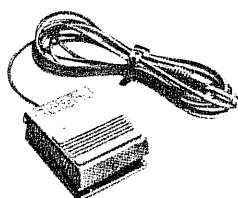

FOOT PEDAL DP-2



FOOT SWITCH FS-1

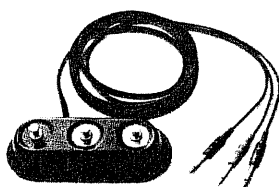

FOOT SWITCH FS-3



HEAD PHONE RH-10



MICROPHONE DR-221



MIC. STAND ST-100

Roland®

10829

UPC

10829



10991

Roland®