

TB-303 SERVICE NOTES

First Edition

SPECIFICATIONS

PATTERN MEMORY CAPACITY

64: 8 (PATTERN) x 2 (PATT. SECTION) x 4 (PATT. GROUP I, II, III, IV)

Contents: Pitch, Value, Accent, Slide

MINIMUM STEP

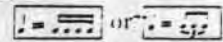

STEPS/measure

→ 1 to 16 steps (2, 3 or 4 meter)

→ 1 to 15 steps (2, 3, 4 or 5 meter)

Scale

3 octaves (PATTERN) w/TRANSCOPE

4 octaves (TRACK) w/Key shift

TRACK MEMORY CAPACITY

64 measures/TRACK Total 256 measures (64 x 7 TRACKS)

Contents: Pattern Order, TRANSCOPE, D.C. *

TUNING Control: approx. ±700 cents (perfect fifth)

TEMPO Control: (♩ = 40 to 300)

CONNECTIONS

Output: Impedance 10kΩ

Headphone: Impedance 8Ω to 30Ω

Gate Out: OFF: 0V; ON: +12V

CV Out: +1V to +5V (1 volt/oct)

SYNC In: DIN connector

MIX In: Impedance 100kΩ

Gain: Unity

POWER

6V: 1.5V battery x 4

9V: AC adaptor

80mA to 120mA

Dimensions: 300(W) x 146(D) x 55(H) mm

Weight: 1.0 kg

READ "PRELIMINARY DIAGNOSIS" ON PAGE 7 BEFORE STARTING TROUBLESHOOTING

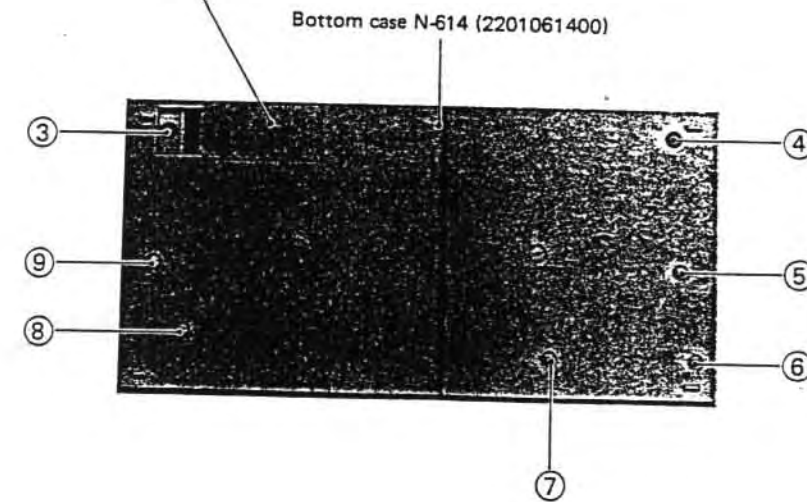
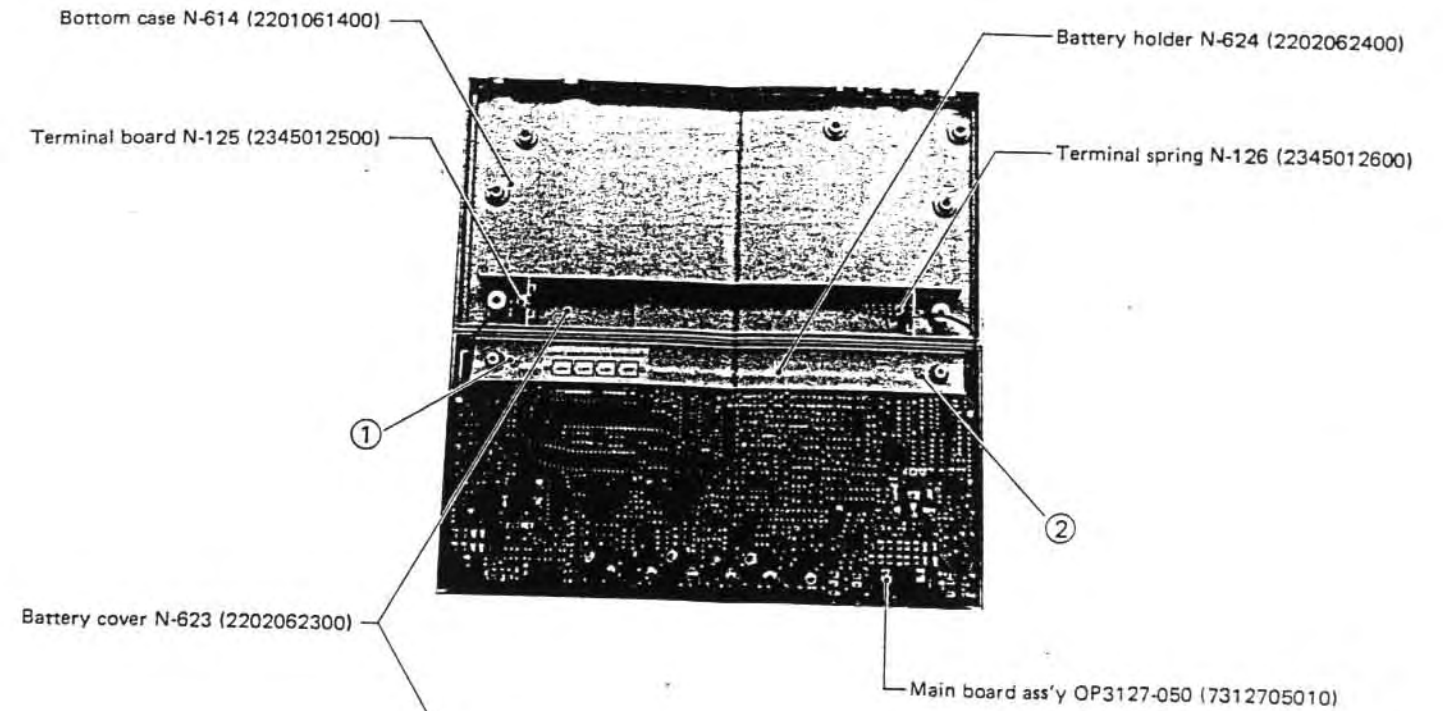
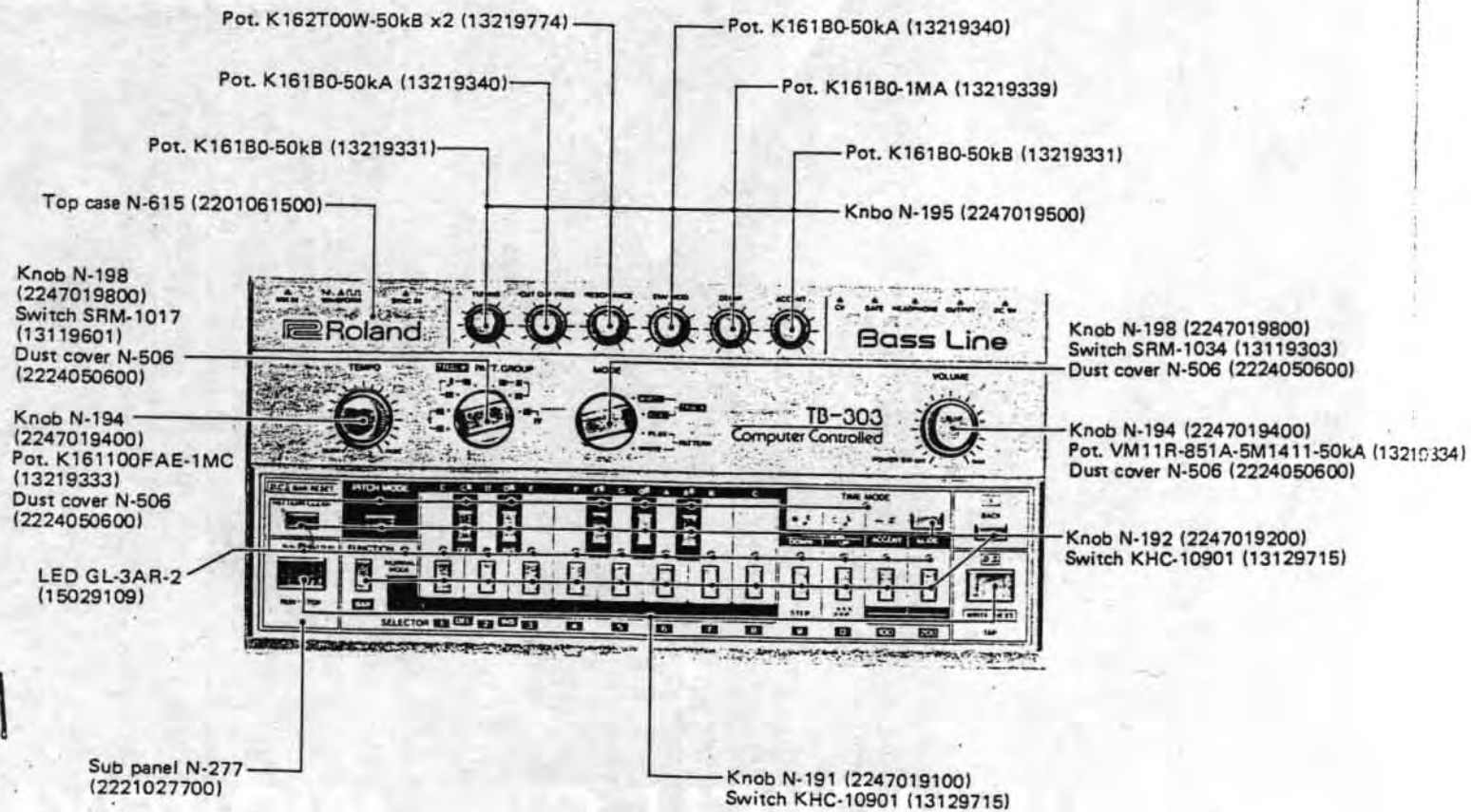

SCREWS ①-④ 3 x 10mm B₁, Fe, Cr, Binding, Self tapping
 SCREWS ⑤-⑨ 3 x 18mm B₁, Fe, Ni, Binding, Self tapping

BOTTOM CASE REMOVAL SCREWS: ③-⑨

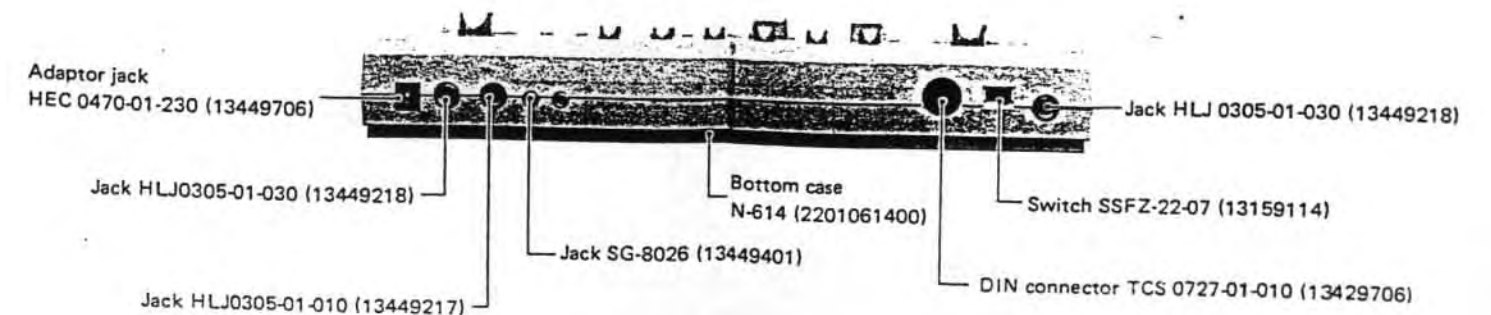

MC14001B CP
Quad 2-Input NOR Gate

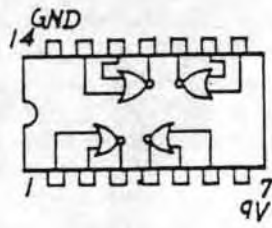

MC14050B
HEX BUFFERS

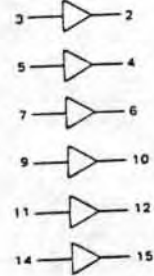

NC = Pin 13, 16
VSS = Pin 8
VCC = Pin 1

AN6562

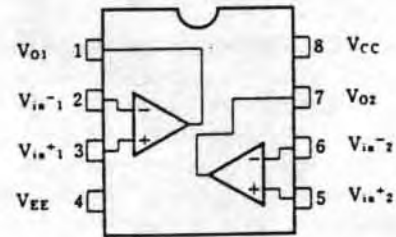

MC14013B

DUAL TYPED FLIP-FLOP

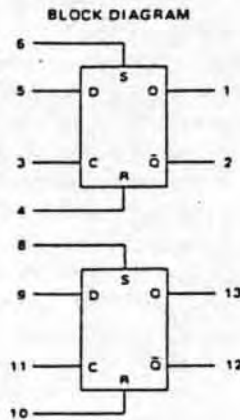

VDD = Pin 14
VSS = Pin 7

INPUTS		OUTPUTS	
CLOCK	DATA	Q	Q̄
0	0	0	1
0	1	0	0
0	X	0	0
0	X	1	0
0	X	0	1
0	X	1	1

X = Don't Care
1 = Level Change

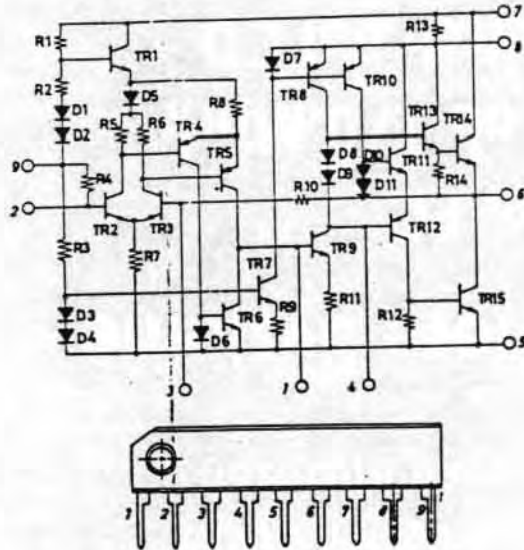

LA4140

HD14584B
Hex Schmitt Trigger

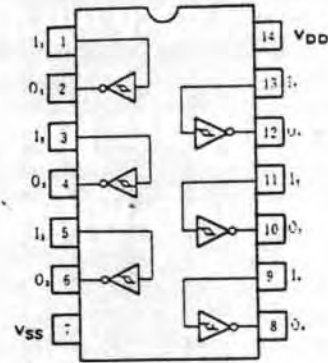

μPD650C
(Top View)

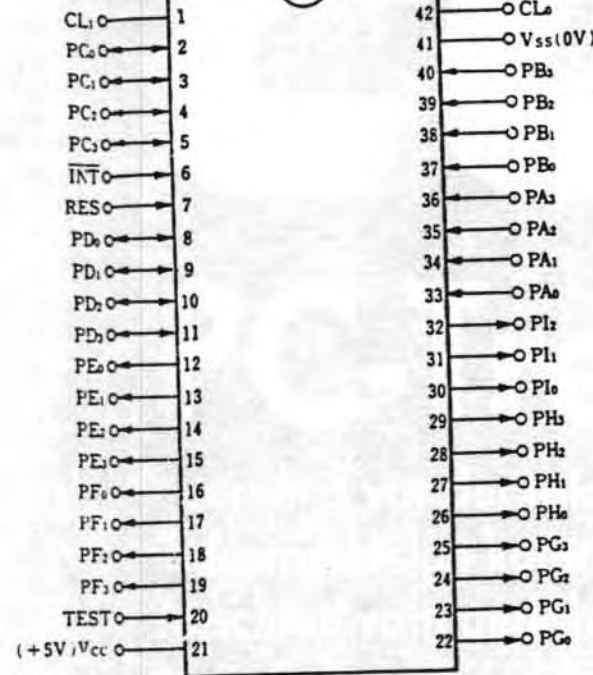

MC14174B

HEX TYPE D FLIP-FLOP

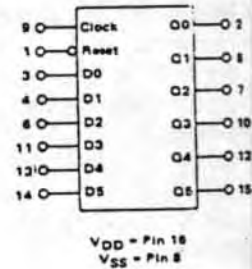

INPUTS			OUTPUT
Clock	Data	Reset	Q
0	0	1	0
0	1	1	1
0	X	1	Q
0	X	0	0

X = Don't Care

MC14556B
DUAL BINARY TO 1-OF-4
DECODER/DEMULTIPLEXER

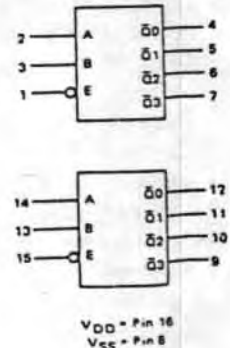

INPUTS		OUTPUTS MC14556B				OUTPUTS MC14556B			
ENABLE	SELECT	Q0	Q1	Q2	Q3	Q0	Q1	Q2	Q3
0	0	0	0	0	0	1	1	1	1
0	0	1	0	0	0	1	0	1	0
0	1	0	0	1	0	0	1	0	1
0	1	1	0	0	0	0	1	1	0
1	X	X	0	0	0	0	1	1	1

X = Don't Care

μPD650C-085 FUNCTIONAL DESCRIPTION

Port	No.	No.	Description
PH (Port H)	0	26	Scanning signal outputs to switches Switching signal outputs to STATUS BUFFER & GATE
	1	27	
	2	28	
PA (Port A)	0	33	Switch scanning signal inputs STATUS (TEMPO CLOCK, START/STOP, TAP) inputs
	1	34	
	2	35	
PB (Port B)	0	37	Inputs from switch board switches
	1	38	
	2	39	
PG (Port G)	0	22	Drive signals to switch board LEDs
	1	23	
	2	24	
PE (Port E)	0	12	MEMORY ADDRESS
	1	13	
	2	14	
PD (Port D)	0	8	PITCH DATA
	1	9	
	2	10	
PF (Port F)	0	16	Data Inputs/Outputs
	1	17	
	2	18	
PC (Port C)	0	2	Data Inputs/Outputs
	1	3	
	2	4	
PI (Port I)	0	30	Memory WE Pitch data latch strobe Gate signal
	1	31	
	2	32	

MC14066B
QUAD ANALOG SWITCH
QUAD MULTIPLEXER

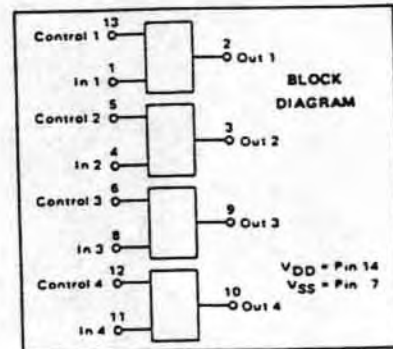

LOGIC DIAGRAM AND TRUTH TABLE (1/4 OF DEVICE SHOWN)

Control	Switch	Logic Diagram Restrictions
0	OFF	VSS ≤ Vin ≤ VDD
1	ON	VSS ≤ Vout ≤ VDD

Vcontrol	Resistance
VSS	Vi to Vout Resistance > 10 ⁹ Ohms typ
VDD	3 × 10 ⁷ Ohms typ

TB-303 BLOCK DIAGRAM

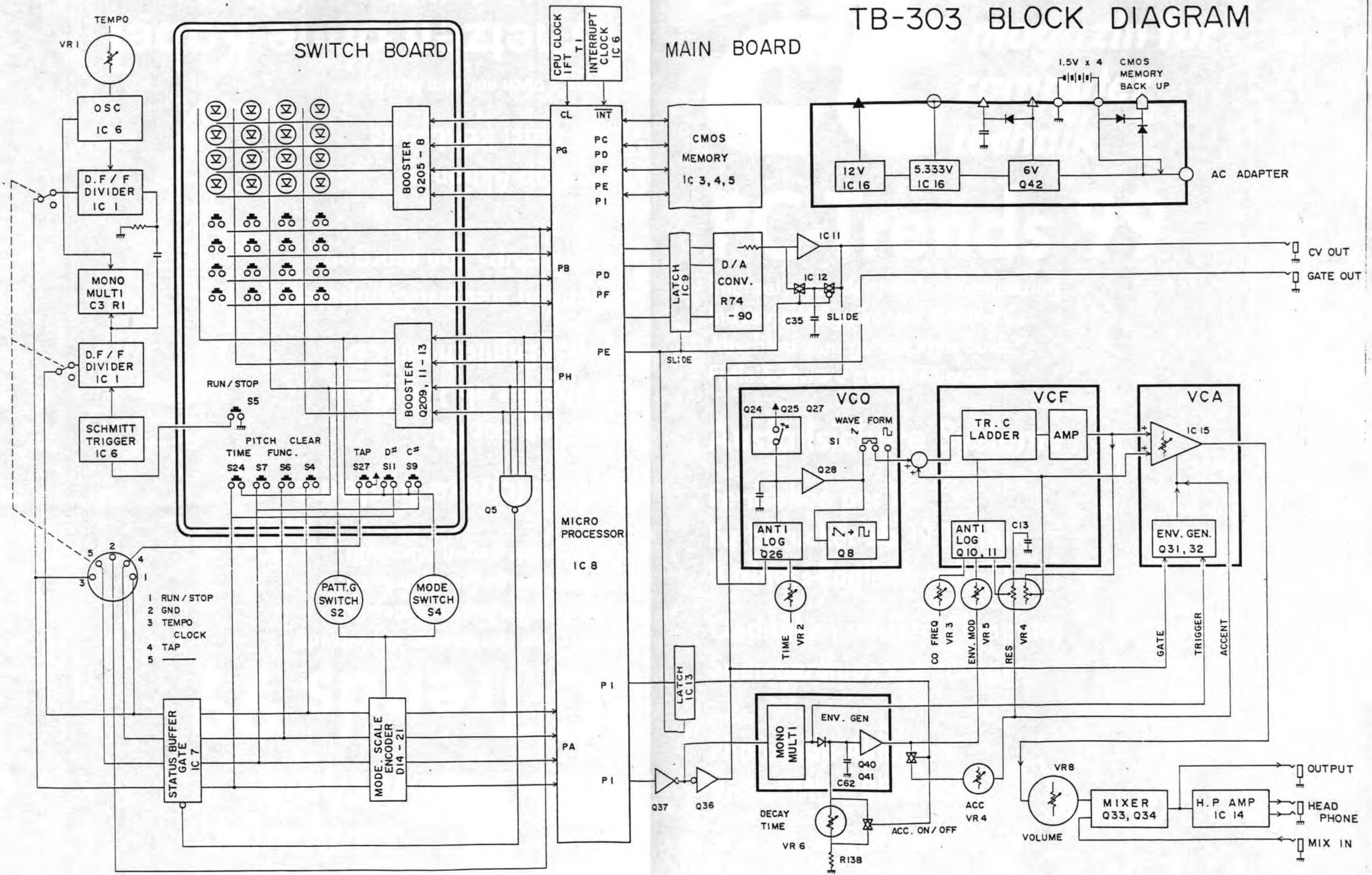

MAIN BOARD

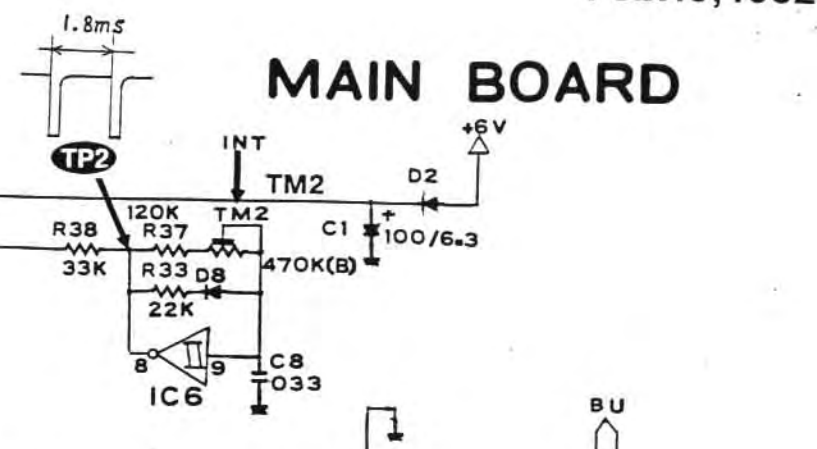

SWITCH BOARD

NOTE:
 ALL NPN TRANSISTORS
 ON THE SWITCH BOARD
 ARE 2SC2021(R)
 ALL PNP TRANSISTORS
 ON THE SWITCH BOARD
 ARE 2SA937(Q)

- SYNC
- 1 RUN/STOP
 - 2 GND
 - 3 TEMPO CLOCK
 - 4 TAP
 - 5 —

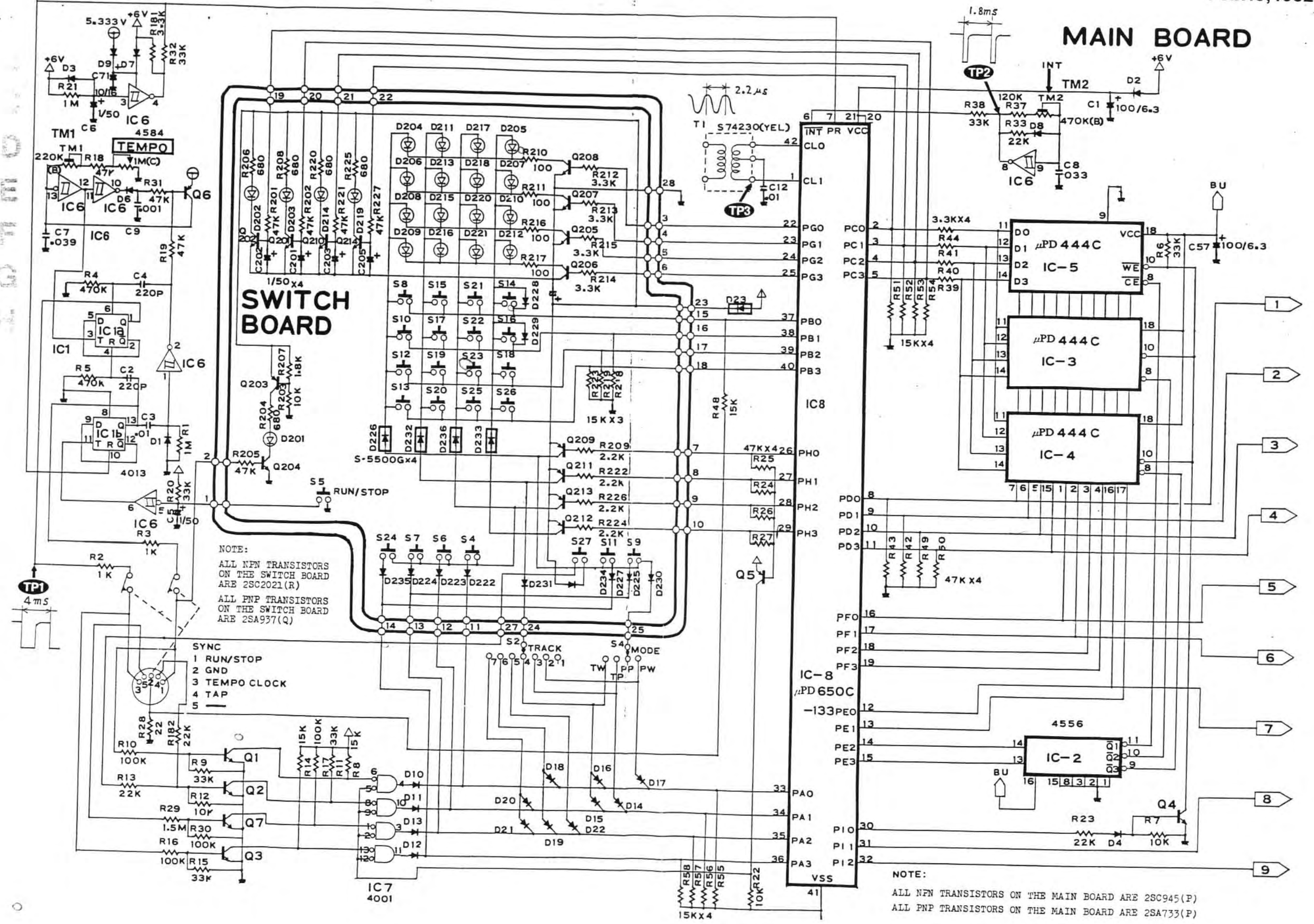

NOTE:
 ALL NPN TRANSISTORS ON THE MAIN BOARD ARE 2SC945(P)
 ALL PNP TRANSISTORS ON THE MAIN BOARD ARE 2SA733(P)

MAIN BOARD

TB-303

POWER SUPPLY

TUNE : 110Hz (SET TUNING CV OUT: 2.75V(A KEY))
 WIDTH : 1 OCT/VOLT

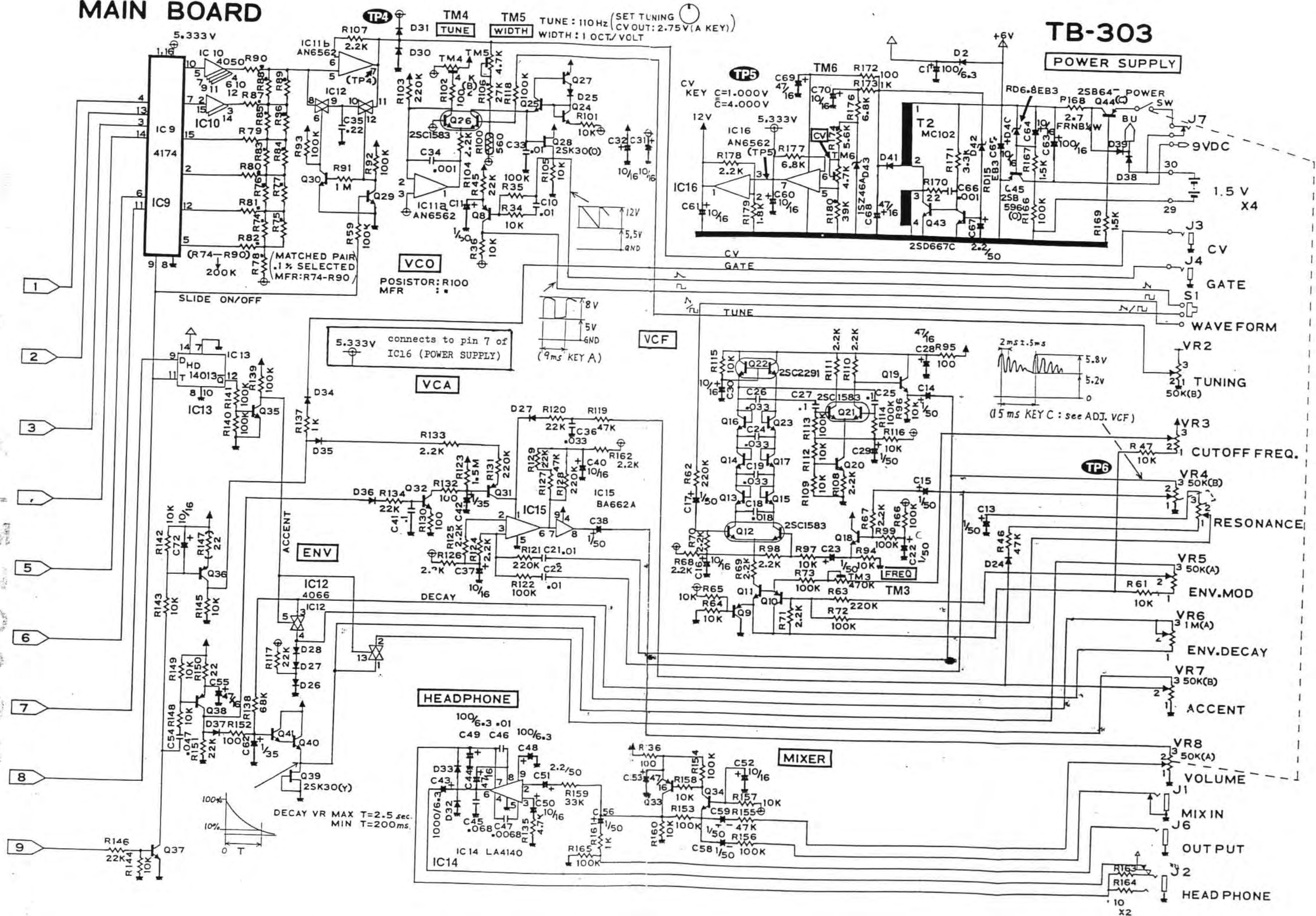

ADJUSTMENT

Adjustments should be done from the component side.
Use digital voltmeter or oscilloscope, as appropriate.

TEMPO

Check point: TP1
Turn TEMPO full clockwise.
Adjust TM1 for:

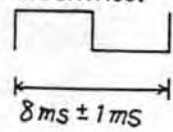

INT CLOCK

Check point: TP2
Adjust TM2 for:

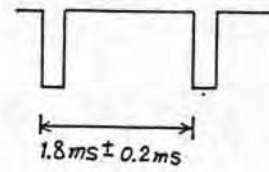

CAUTION:

The following adjustments will be done in PATTERN WRITE mode.
If existing rhythm patterns need to be restored, locate a PATTERN that contains no rhythms or the easiest ones to copy and write it down.

CV

Check point: CV out jack
With PITCH mode, press low C key and note the reading - CVL.
Press high C key, adjust TM6 for CVL+1.000V±3mV - CVM.
While holding down TRANSPOSE UP, press high C key, confirm that the reading is CVM+1.000±3mV.

View from component side

MAIN BOARD

OP3127-050

(7312705010)

(pcb 291-502C)

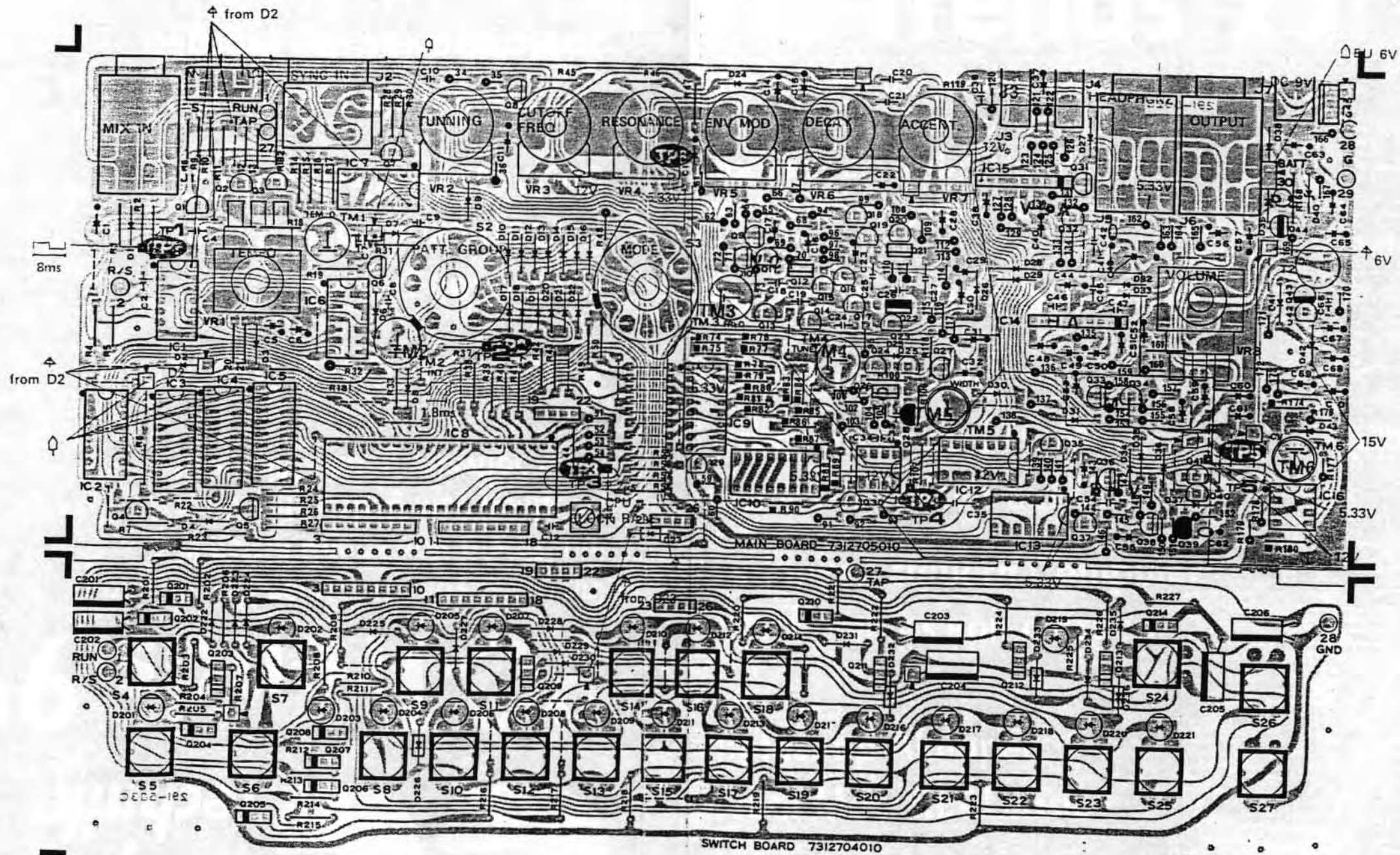

SWITCH BOARD

OP3127-040

(7312704010)

(pcb 291-503C)

VCO
 Check point: Q28 source or S1 WAVE-FORM terminal.
 Set TUNE in its middle position.
 With PITCH mode. While tapping CL and CH keys alternately, adjust TM5 WIDTH for 2:1 waveforms:

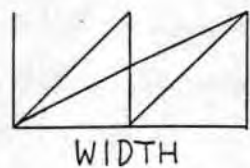

Press A key and adjust TM4 for 110Hz.
 Confirm $4:1 \pm 0.5\%$ with CL and CH + TRANSPOSE UP.

VCF
 Check point: TP6
 Panel settings:
 CUTOFF FREQ : center
 WAVEFORM : SAWTHOOOTH
 RES : Full clockwise
 ENV MOD,
 DECAY, ACC : Full counterclockwise

Afdjust TM3 for:

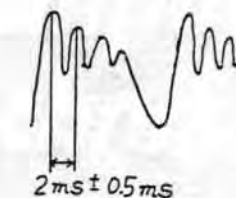

View from foil side

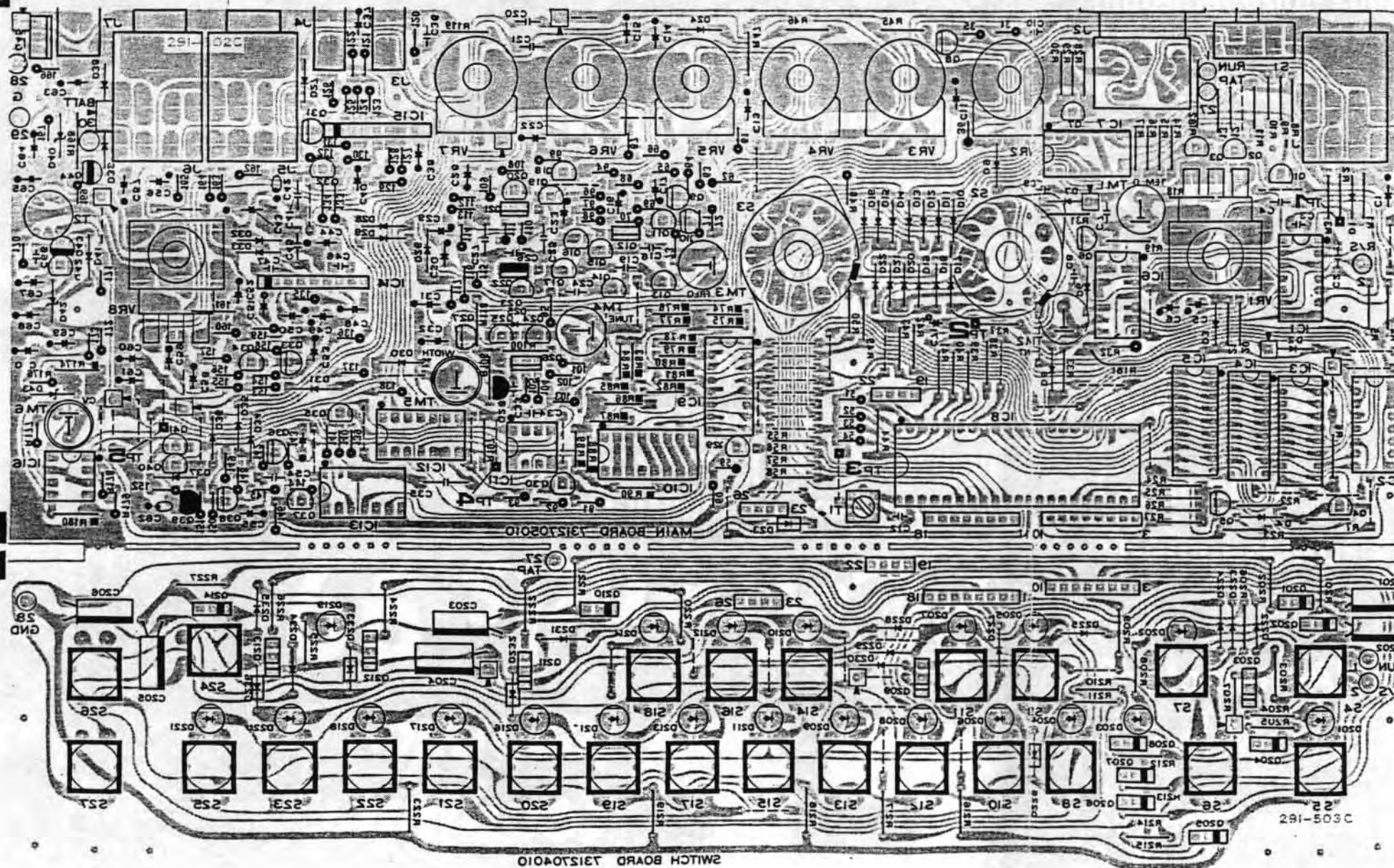

PRELIMINARY DIAGNOSIS

BATTERY

First check the DC voltage.
 Most users are not so familiar with battery operated equipment as to suspect aged dry cells in the malfunctioning (silent) TB-303 when LEDs other than RUN/BATTERY are lit up.

MISOPERATION

The versatile TB-303 inevitably needs to be manipulated according to what is instructed in the TB-303 Owner's manual.
 Symptoms listed below are likely to be found (by the user) in a unit which will be returned for servicing, as an evidence of defect.
 Confirm the operation following to the steps described in the manual — on the page(s) referenced.

- * Patterns (especially note value) are not reproduced as they should be.
 " 4 TO WRITE YOUR OWN BASS LINE" PP. 49-64
- * Incorrect PATTERN selection
 "IMPORTANT NOTES" P. 3
- * The LED above the selected PATTERN switch does not flush
 " 2 Setting the STEP number" P. 53
 "b. WRITING A BASS PATTERN IN 3/4" PP. 55-57
- * TRACK fails to store data being written into it.
- * Phrases do not repeat in order in TRACK PLAY mode.
 "SELECTING THE TRACK" PP. 23-32
 "B. TO WRITE YOUR OWN BASS LINE" PP. 64-68
- * Melody does not run at the beginning of the 1st measure in TRACK PLAY mode.
 " 4 LET'S PLAY THE TRACK" PP. 31-32

	2SC536F
	2SA733P
	2SC2021R
	2SA937Q

VCF ENVELOPE MODULATION

In the conventional VCF configuration, envelope modulation voltages applied to modulation control voltage input of VCF rise from a fixed potential to their values regardless of shape and amount of envelope and fall back to the same potential. Fig. 1. In this setup, an attempt to deepen envelope modulation is increment of control voltage in one direction, only to open up filter. Resultants are; higher the control voltage input, longer the period of time cutoff point travels through higher frequency range in which significant aural sound characteristic changes do not occur, whereas notes are brightened.

To compensate for the limitation this impose, there is a gimmick in the TB-303 VCF circuit. The Q9 has a key role in this arrangement. See Fig. 2. It develops bias for Q10 and Q11 to set initial cutoff point at the center of frequency range. Within the range even a small amount of voltage change can create a appreciable modulation.

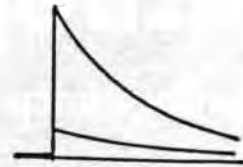

Fig. 1

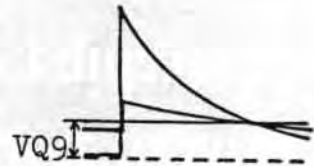

Fig. 3

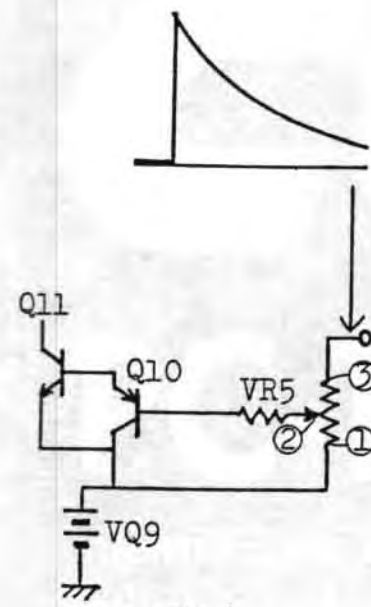

Fig. 2

Rotating wiper ② of VR5 closer to terminal ③ increases ENV MOD voltage being fed to base of Q10 while changing the bias which in turn lowers VCF cutoff frequency. See Fig. 3. This is equal to turning CUTOFF knob counterclockwise and, since Q10 and Q11 in combination convert control voltage to the current in anti-log fashion, the cutoff point stays in an effective frequency range for the most portion of envelope sweeping duration.

PARTS LIST

PANEL

2201061500	Top case	N615	top
2201061400	Bottom case	N-614	bottom
2202062300	Battery cover	N-623	
2202062400	Battery holder	N-624	
2221027700	Sub panel	N-277	

SOCKET

13429706	DIN connector	TCS0737-01-010	Sync
13449218	Jack	HLJ0305-01-030	MONO
13449217	Jack	HLJ0305-01-010	STEREO
13449401	Jack	SG8026	MINI
13449706	Adaptor jack	HEC0470-01-230	AC adaptor

TRANSFORMER COIL

12449217	IFT coil	S74230 (yellow)	CPU clock
12449507		MC102C	DC-DC converter

SWITCH

13119601	SRM1017	rotary	TRACK, INSTRUMENT
13119303	SRM1034	rotary	MODE
13129715	KHC10901	push	All switches on the switch board
13159114	SSFZ-22-07	slide	SYNC in/out

SEMICONDUCTOR

LSI			
15179126	μPCD650C-133	CMOS CPU	
15179305	μPD444C	CMOS RAM	

IC

15159101H0	HD14001BP	Quad 2-input NOR gate
15159105	HD14013BP or MN4013B	Dual type D flip-flop
15129128	HD14050BP	Hex buffers

15159115	HD14066BP	Quad analog switch
		Quad multiplexer
15159133	HD14174BP	Hex type D flip-flop
15159308	HD14556BP	Dual binary to 1-of-4 Decoder/Demultiplexer
15189138	AN6562	Dual op amp
15229802	BA662(A)	Vari-conductance amp
15159303H0	HD14584B	Hex Schmitt trigger
15199509	LA4140	AF Power amp

TRANSISTOR

15119105	2SA733(P)	
15119602	2SB647(C)	
15119806	2SB596(O)	
15129602	2SD667(C)	
15129121	2SC2021(R)	
15129130	2SC1583(F)	Dual Tr
15129131	2SC2291(F)	Dual Tr

FET

15139101	2SK30TM(Y)
15139102	2SK30TM(O)

LED

15029109	GL3AR2
----------	--------

DIODE

15019120	1S2473	Si diode
15019209	S-5500G	
15019122	1S-188FM	Ge diode
15019655	RD6.8EB-3 or 15019656	RD6.8EB2-T
15019653	RD15EB-3	
15019126	1SS-133	Si diode
15019630	158-46A	

POTENTIOMETER

13219333	K161100FAE-IMC	tempo
13219334	VM11R851A-5M1411-50KA	master vol. & power switch
13219331	K161B0-50KB	TUNING, ACCENT
13219340	K161B0-50kA	CUT OFF FREQ, ENV MOD
13219339	K161B0-1MA	DECAY
13219774	K162T00W-50kB x 2	RESONANCE
13299116	H1051A016-47kB	trimmer
13299119	H1051A021-220kB	trimmer
13299122	H1051A023-470kB	trimmer
13299543	H1021A011-4.7kB	trimmer

RESISTOR

12559708	FRNB 2.7Ω	Fuse resistor
----------	-----------	---------------

CIRCUIT BOARD ASSEMBLY

7312705010	MAIN BOARD	OP3127-050	(PCB 291 502C)
7312704010	SWITCH BOARD	OP3127-040	(PCB 291 503C)

KNOB

2247019400	Knob	N-194	master VR & TEMPO
2247019500	Knob	N-195	instrument level
2247019100	Knob	N-191	RUN/STOP, TAP
2247019200	Knob	N-192	step number
2247019800	Knob	N-198	rotary switch

OTHERS

1299503	PCB Holder	LCBS-12NS	
2219028700	Holder	N-287	Potentiometer for master vol. & tempo
2343097600	Flat cable		8-core
2343097700	Flat cable		4-core
2345012500	Terminal board		Battery + side
2345012600	Terminal spring		Battery - side
2224011500	Dust cover	N-115	slide switch
2224050600	Dust cover	N-506	master vol., tempo, rotary switch