

VS-880EX Newly added functions (Ver.2.0)

1999. 4. 19, 1st edition

Following functions have been added to the system software for VS-880EX (Ver.2.0 or later). Song data created with the VS-880EX with the system Ver.1.00 is completely compatible with the system Ver.2.0.

How to check the version of the system software

Current system software version number of your VS-880EX will be displayed at REMAINING TIME in the display when you power on the VS-880EX. Please use the system software Ver.2.0 or later.

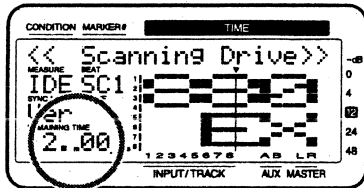

Added effects algorithms

The following effects algorithms will be added.

- Making the volume consistent for each frequency band (Mastering Tool Kit) (p.1)
- Modeling various speakers (Speaker Modeling) (p.3)

Making the Volume Consistent for Each Frequency Band (Mastering Tool Kit)

This is a compressor that can be applied independently to each frequency band (high, mid, and low ranges). When mastering to MD or DAT, or when using a CD-R disc to produce your own original audio CDs, this allows you to master at the optimal level.

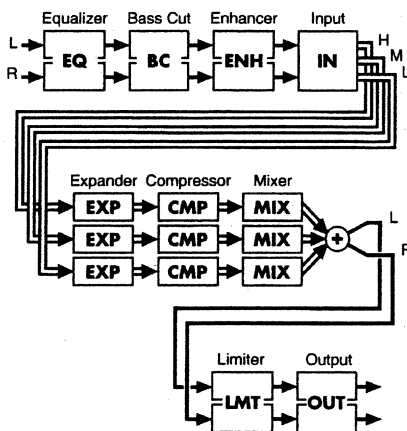

The mastering tool kit can be used in either FX1. When you use it, FX2 will be unavailable.

EQ (Equalizer)

This is a four-band equalizer with low, low-mid, high-mid, and high ranges.

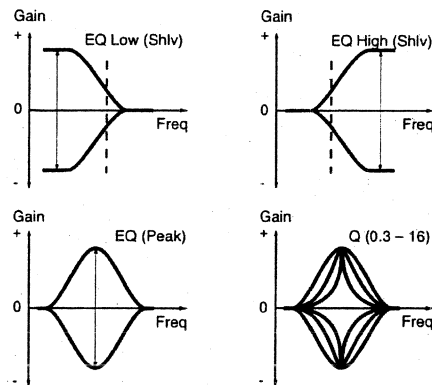

EQ:EQ (Equalizer)

Off, On

Turns the equalizer on/off.

EQ:InputG (Input Gain)

-24 - +12 dB

Adjusts the overall volume level of the signal before entering the equalizer.

EQ:LowType (Low Type)

Shlv, Peak

EQ:HiType (High Type)

Shlv, Peak

Selects the type of the low range (Low) and high range (High) equalizer. (Shlv: shelving type, Peak: peaking type).

EQ:LowG (Low Gain)

-12 - +12 dB

EQ:LoMidG (Low Middle Gain)

-12 - +12 dB

EQ:HiMidG (High Middle Gain)

-12 - +12 dB

EQ:HiG (High Gain)

-12 - +12 dB

Adjust the gain (the amount of boost or cut) for each equalizer band.

EQ:LowF (Low Frequency)

20 - 2,000 Hz

EQ:LMidF (Low Middle Frequency)

20 - 8,000 Hz

EQ:HiMidF (High Middle Frequency)

20 - 8,000 Hz

HIF (High Frequency)

1.4 - 20 kHz

Adjust the center frequency of each equalizer band.

EQ:LowQ (Low Q)

0.3 - 16

EQ:LoMidQ (Low Middle Q)

0.3 - 16

EQ:HiMidQ (High Middle Q)

0.3 - 16

EQ:HiQ (High Q)

0.3 - 16

Adjust the width of the area around the center frequency (Freq) that will be affected by the Gain. As these values are raised, a narrower range will be affected.

EQ:Level

-24 - +12 dB

Adjusts the overall volume of the signal that has passed through the equalizer.

BC (Bass-Cut Filter)

This removes unwanted low-frequency components, such as pop noise.

BC:BassCut

Off, On

Turns the bass-cut filter on/off.

BC:Freq (Frequency)

Thru, 20 - 2,000 Hz

Adjusts the cutoff frequency of the bass-cut filter.

ENH (Enhancer)

This effect adds a phase-shifted signal to the original signal,

VS-880EX Newly added functions (Ver.2.0)

enhancing the presence of the sound, and bringing it to the foreground.

ENH:Enhancer Off, On
Turns the enhancer on/off.

ENH:Sens (Sensitivity) 0 – 100
Adjusts the degree to which the enhancer will respond to the volume of the input signal.

ENH:Freq (Frequency) 1.0 – 10.0 kHz
Adjusts the frequency at which the enhancer will begin to take effect. The effect is applied at frequencies above the specified value.

ENH:MixLvl (Mix Level) -24 – +12 dB
Adjusts the amount of effect sound that will be added to the original sound.

IN (Input)

The input signal is divided into three parts by frequency band.

IN:Gain -24 – +12 dB
Adjusts the overall volume level of the signal before it enters the expander (EXP) and compressor (CMP).

IN:D-Time (Detect Time) 0 – 10 ms
If the original signal is slightly delayed before being input, the expander/compressor will be able to use more processing time, and can adjust the level more appropriately. Adjusts the time by which the original signal is delayed. **The output signal from the Mastering Tool Kit is delayed by the time set here.**

IN:LSP (Low Split Point) 20 – 800 Hz
IN:HSP (High Split Point) 1.6 – 16 kHz
Specify the frequencies at which the original signal will be split into three parts.

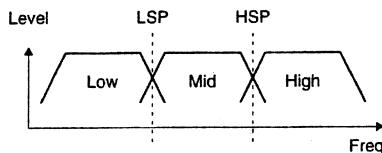

EXP (Expander)

This effect restricts the output by a specific ratio when low-level signals are input.

EXP:Expander Off, On
Turns the expander on/off.

EXP:L.Thre (Low Threshold) -80 – 0 dB
EXP:M.Thre (Middle Threshold) -80 – 0 dB
EXP:H.Thre (High Threshold) -80 – 0 dB
Specify the level at which the expander will begin to take effect.

EXP:L.Ratio (Low Ratio) 1:1 – 1:16, 1:INF
EXP:M.Ratio (Middle Ratio) 1:1 – 1:16, 1:INF
EXP:H.Ratio (High Ratio) 1:1 – 1:16, 1:INF
Adjust the ratio by which the output is restricted when the input level is below the threshold level.

EXP:L.Atck (Low Attack) 0 – 100 ms

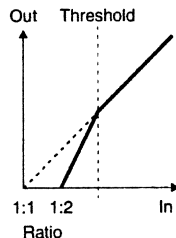

EXP:M.Atck (Middle Attack) 0 – 100 ms
EXP:H.Atck (High Attack) 0 – 100 ms
Adjust the time from when the input level falls below the threshold level until the expander begins to take effect.

EXP:L.Rel (Low Release) 50 – 5,000 ms
EXP:M.Rel (Middle Release) 50 – 5,000 ms
EXP:H.Rel (High Release) 50 – 5,000 ms
Adjust the time from when the input level exceeds the threshold level until the expander effect ceases to be applied.

CMP (Compressor)

When a high-level signal is input, this effect restricts the output at a specified ratio.

CMP:Comp (Compressor) Off, On
Turns the compressor on/off.

CMP:L.Thre (Low Threshold) -24 – 0 dB
CMP:M.Thre (Middle Threshold) -24 – 0 dB
CMP:H.Thre (High Threshold) -24 – 0 dB
Specify the level at which the compressor will begin to take effect.

CMP:L.Ratio (Low Ratio) 1:1 – 1:16, 1:INF
CMP:M.Ratio (Middle Ratio) 1:1 – 1:16, 1:INF
CMP:H.Ratio (High Ratio) 1:1 – 1:16, 1:INF
Adjust the ratio by which the output will be restricted when the input level exceeds the threshold level.

CMP:L.Atck (Low Attack) 0 – 100 ms
CMP:M.Atck (Middle Attack) 0 – 100 ms
CMP:H.Atck (High Attack) 0 – 100 ms
Adjust the time from when the input level exceeds the threshold level until the compressor takes effect.

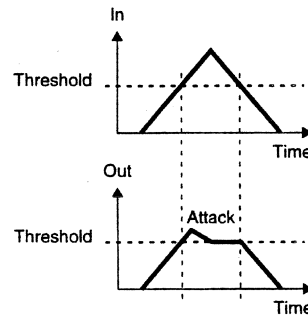
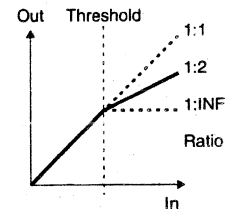

CMP:L.Rel (Low Release) 50 – 5,000 ms
CMP:M.Rel (Middle Release) 50 – 5,000 ms
CMP:H.Rel (High Release) 50 – 5,000 ms
Adjust the time from when the input level falls below the threshold level until the compressor no longer has an effect.

Modeling various speakers (Speaker Modeling)

You can model the acoustical characteristics of a variety of speakers, ranging from high-level professional monitor speakers used in studios worldwide, to the speakers of small televisions or portable radios.



Speaker modeling has been calibrated so that the optimal effect will be obtained when Roland DS-90 powered monitors are connected digitally. If you are using other speakers, you may not be able to obtain the desired effect.

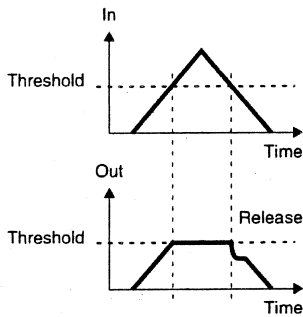

The compressor provides threshold (Thre) and Ratio settings that automatically adjust a signal to the optimal level. Since lengthening the attack (Atck) may cause distortion, a -6 dB margin is provided. Adjust the mixer (MIX) level as necessary.

MIX (Mixer)

Adjusts the volume for each of the three frequency bands that were divided.

MIX:LowLvl (Low level)	-80 – +6 dB
MIX:MidLvl (Middle level)	-80 – +6 dB
MIX:HiLvl (High level)	-80 – +6 dB

These adjust, for each band, the volume level of the signal that has passed through the expander (EXP) and compressor (CMP).

LMT (Limiter)

This effect restricts excessive output levels.

LMT:Limiter Off, On
Turns the limiter on/off.

LMT:Thre (Threshold) **-24 – 0 dB**
Specifies the level at which the limiter will begin to operate.

LMT:Atck (Attack) **0 – 100 ms**
Adjusts the time from when the input level exceeds the threshold level until when the limiter begins to operate.

LMT:Rel (Release) **50 – 5,000 ms**
Adjusts the time from when the input level falls below the threshold level until when the limiter ceases to be applied.

OUT (Output)

Make settings related to the overall output.

OUT:SoftClip Off, On
This suppresses the obtrusive distortion that occurs when the compressor or limiter effect is applied in an extreme fashion.

OUT:Dither Off, 24 – 8 bit
By adding a minute level of noise (dither), this smoothes the transition where the sound disappears.

OUT:Level **-80 – +6 dB**
This adjusts the overall volume level of the sound that has passed through the limiter (LMT).

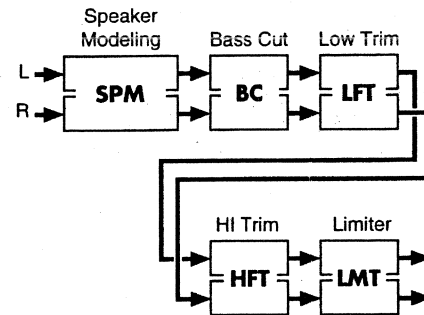

SPM (speaker modeling)

SPM:Modeling Off, On
Turns the speaker modeling on/off.

SPM:Mdl (Model)
THRU, FLAT, Pwd.BLK, Pwd.E-B, Pwd.MAC, SmiCUBE, Wh.CONE, WhTISUE, RADIO, SmallTV, BoomBOX, BoomLoB
Select the speaker whose characteristics will be simulated (modeled).
THRU:

Modeling will not be applied, and the sound will be output without change. Use this as a comparison with the speaker-modeled sounds.

FLAT:
Modeling is used to compensate the DS-90, to produce an even flatter sound with a wider range.

Pwd.BLK:
A widely used model of powered monitors (two-way type, with a woofer diameter of 170 mm (6-1/2 inches)).

Pwd.E-B:
Powered monitors characterized by a bright tone.

Pwd.MAC:
Powered monitors characterized by an extended low-frequency response.

SmiCUBE:
Small full-range speakers widely used in recording studios.

Wh.CONE:
Sealed enclosure two-way speakers known for their white woofers and widely used in recording studios.

WhTISUE:
A more mild sound, with tissue paper affixed over the tweeters of the above "White Cone" speakers.

RADIO:
Small pocket-type radio.

SmallTV:
Speakers built into a 14 inch size television.

BoomBOX:
Radio cassette recorder.

VS-880EX Newly added functions (Ver.2.0)

BoomLoB:

Radio cassette recorder with the Low Boost switched on.

SPM:Phase Nor, Inv

Specifies the phase of the speakers.

Nor: Same phase as the input.

Inv: Opposite phase of the input.

BC (Bass-Cut Filter)

This removes unwanted low-frequency components, such as pop noise.

BC:BassCut Off, On

Switches the bass-cut filter on/off.

BC:Freq (Frequency) Thru, 20 – 2,000 Hz

Adjusts the cutoff frequency of the bass-cut filter.

LFT/HFT (Frequency Trimmer)

LFT:L.F.Trim (Low Frequency Trimmer) Off, On

HFT:H.F.Trim (High Frequency Trimmer) Off, On

Turns the frequency trimmer on/off.

LFT:Gain -12 – +12 dB

HFT:Gain -12 – +12 dB

For each trimmer, adjusts the gain (amount of boost/cut).

LFT:Freq (Frequency) 20 – 2,000 Hz

HFT:Freq (Frequency) 1.0 – 20.0 kHz

Set the center frequency of each trimmer.

LMT (Limiter)

This effect limits excessive output levels.

LMT:Limiter Off, On

Turns the limiter on/off.

LMT:Thresh (Threshold) -60 – 0 dB

Specifies the level at which the limiter will begin to operate.

LMT:Rel (Release) 0 – 100

Adjusts the time from when the input level falls below the threshold level until the limiter ceases to operate.

LMT:Level -60 – +24 dB

Adjusts the volume level of the sound that has passed through the limiter.

Effective ways to use speaker modeling

Speaker modeling can be used effectively when you wish to audition how your final production (an original audio CD, or a mixed-down MD or DAT etc.) will sound on a variety of speakers. Here we will explain how speaker modeling can be used when producing an audio CD to audition the final result. Read this section in conjunction with the DS-90 owner's manual.

1. Digitally connect the VS-880EX Ver.2.0 to the DS-90 (coaxial or optical.) Set the DS-90's input select switch to the digital input that you are using.
2. Make settings so that the mix bus is output from the digital output connector you connected in step 1.
 - 2-1. Hold down [SHIFT] and press [EDIT (FADER)].
 - 2-2. Press PARAMETER [◀◀] or [▶▶] to let "DigitalOut1=" or "DigitalOut2=" appears in the display.

2-3. Select "MST" by rotating the TIME/VALUE dial.

3. Make settings so that the mixdown can be performed while inserting effects.

3-1. Hold down [SHIFT] and press [EDIT (FADER)].

3-2. Press PARAMETER [◀◀] or [▶▶] to let "MST FX1 INS Sw=" appears in the display.

3-3. Select "On" by rotating the TIME/VALUE dial.

4. Select the effect that will be inserted. For this example, select a patch that uses the speaker modeling algorithm.

4-1. Press [EFFECT] to let "EFFECT1 PRM?" appears in the display.

4-2. Press [YES (ENTER)].

4-3. Use the TIME/VALUE dial to select a patch.

4-4. Press [YES (ENTER)] again.

5. Press [PLAY]. Switch patches, and hear the sound as it would be heard through various speakers.

6. When you are ready to perform the actual mixdown, turn off the speaker modeling patch that is inserted.



If, for example, you are modeling a set of radio-cassette recorder speakers and perform the mixdown without turning off the inserted speaker modeling patch, the sound as it would be heard on a radio-cassette would be recorded to the external MD/DAT; etc. To avoid this, turn off speaker modeling before you perform the actual mixdown.

Added Preset Patch List

The following effects patches will be added with VS-880EX Ver.2.0.



You cannot select preset patches C10 – C28 (Mastering Tool Kit) for FX2. These patches must be used for FX1.

Mastering Tool Kit (19 presets)

No.	Patch Name	Type	Input
C10	MTK:Mixdown	Insert	Stereo
C11	MTK:PreMastr	Insert	Stereo
C12	MTK:LiveMix	Insert	Stereo
C13	MTK:PopMix	Insert	Stereo
C14	MTK:DanceMix	Insert	Stereo
C15	MTK:JinglMix	Insert	Stereo
C16	MTK:HardComp	Insert	Stereo
C17	MTK:SoftComp	Insert	Stereo
C18	MTK:ClnComp	Insert	Stereo
C19	MTK:DnceComp	Insert	Stereo
C20	MTK:OrchComp	Insert	Stereo
C21	MTK:VocalCmp	Insert	Stereo
C22	MTK:Acoustic	Insert	Stereo
C23	MTK:RockBand	Insert	Stereo
C24	MTK:Orchestr	Insert	Stereo
C25	MTK:LoBoost	Insert	Stereo
C26	MTK:Brighten	Insert	Stereo
C27	MTK:DjsVoice	Insert	Stereo
C28	MTK:PhoneVox	Insert	Stereo

Speaker Modeling (11 preset)

No.	Patch Name	Type	Input
C29	SPM:SuperFlt	Insert	Stereo
C30	SPM:P.GenBlk	Insert	Stereo
C31	SPM:P.E-Bs	Insert	Stereo
C32	SPM:P.Mack	Insert	Stereo
C33	SPM:SmlCube	Insert	Stereo
C34	SPM:WhiteCon	Insert	Stereo

No.	Patch Name	Type	Input
C35	SPM:W.C+tiss	Insert	Stereo
C36	SPM:S.Radio	Insert	Stereo
C37	SPM:SmallTV	Insert	Stereo
C38	SPM:BoomBox	Insert	Stereo
C39	SPM:BB.LowBs	Insert	Stereo

Display
FX1 Sel

EFFECT
C10:MTK:Mixdown



If the recording mode of the song is set to "MAS", above mentioned settings for TR7 and 8 are automatically applied to TR5 and 6.

Added EZ routing (Mastering)

To EZ Routing (template/step edit), "Mastering" for mixdown is newly added. With this routing, you can adjust the balance of each track (up to six) and send them to the effect bus, then record the returned signals from the effects to the other two tracks (mastering). This is convenient, for example, for mixing the tracks 1 - 6, processing them with Mastering Tool Kit effect, then recording the result to tracks 7 and 8.

Mastering/Template

1. Press [EZ ROUTING] several times until "EZR Mastering?" appears in the display.
2. Press [YES]. "EZR Use Template?" appears in the display.
3. Press [YES] again.
4. When the routings has been recalled, "Complete" appears in the display, and return to Play condition. At this time, the mixer setting will be as follows.

Playback Track	TR1 - 6
Recording Track	TRd (TR7, 8)
FX assigned to the Recording Track	FX1 Return

Display	Track Mixer
Assign	TRd FX1=On
ATT	current value
Phase	current value
MIX Sw	Off (TR1 - 6) On (TRd)
Mix Level	100 (TRd)
Mix Pan	L63 (TR1, 3, 5) R63 (TR2, 4, 6)
Mix Bal	0 (TRd:TR7=L63, TR8=R63)
V.Track	current value
EQ Switch	On

Display	Track Mixer
EQL	0 dB/300 Hz
EQH	0 dB/4 kHz
AUX Sw	Off
Channel Link	Off (TR1 - 6) On (TRd)
Fader Link	Off
FX1 Ins	Off
EFFECT1	PstFade (TR1 - 6) Off (TRd)
EFFECT1 Send	100
EFFECT1 Pan	L63 (TR1, 3, 5) R63 (TR2, 4, 6)
FX2 Ins	Off
EFFECT2	Off

Display	Masterblock
Master Sel	MIX
MST FX1 Ins Sw	Off
MST FX2 Ins Sw	Off
EQ Sel	2BandEQ
Direct Out	Off

Mastering/Step Edit

1. Press [EZ ROUTING] several times until "EZR Recording ?" appears in the display.
2. Press [YES]. "EZR Use Template" (do you wish to apply the template?) appears in the display.
3. Press [NO].
4. Specify the track on which you will record. Press the STATUS button of the track that you wish to record. You can rotate the TIME/VALUE dial to select the V-track that you wish to record. Then press PARAMETER [▶▶].

EZR REC Track = 8-1

5. Specify the tracks for which you will turn Channel Link ON. Press the STATUS button of the tracks for which you wish to turn Channel Link ON, and rotate the TIME/VALUE dial. Then press PARAMETER [▶▶].

EZR TRd Link = On

6. Specify the track on which you will playback. Press [SELECT (CH EDIT)] of the track that you wish to playback. Then press PARAMETER [▶▶].

EZR TR1 = Off

7. Adjust the pan/balance of the channel. Press the SELECT (CH EDIT) button for the input whose pan/balance you wish to adjust, and use the TIME/VALUE dial. Then press PARAMETER [▶▶].

EZR TRd OfdBal = 0

8. Adjust the level of the channel. Press the SELECT (CH EDIT) button for the input whose level you wish to adjust, and use the TIME/VALUE dial. Then press PARAMETER [▶▶].

EZR TRd OfLev = 100*

9. "Use EFFECT1 ?" appears in the display. If you wish to use FX1, press [YES]. If you do not wish to use FX1, press [NO] and proceed to step 12.
10. The effect patch will be displayed. Use the TIME/VALUE dial to select the effect patch that you wish to use (C10:MTK:Mixdown; etc.). Then press PARAMETER [▶▶].
11. If you wish to insert FX1, select either "Ins," "InsL," "InsR," or "InsS," and press PARAMETER [▶▶]. If you wish to use FX1

VS-880EX Newly added functions (Ver.2.0)

in a send/return configuration, select "Off" and press PARAMETER [▶▶].

EZR TR1 FX1 Ins= Off

- 11-1. Use the TIME/VALUE dial to adjust the insert send level, and press PARAMETER [▶▶].
- 11-2. Use the TIME/VALUE dial to adjust the insert return level, and press PARAMETER [▶▶].
12. If you wish to send the input to the FX1 bus, select either "Pre" or "Pst," and press PARAMETER [▶▶].

EZR TR1 FX1 Snd= Pst

- 12-1. Use the TIME/VALUE dial to adjust the send level, and press PARAMETER [▶▶]. If in step 11 you selected except "Off," the sound already processed by the FX will be sent to the FX bus.
- 12-2. Use the TIME/VALUE dial to adjust the send pan, and press PARAMETER [▶▶].
- 12-3. If you wish to record the effect which you are using in a send/return configuration, press the [STATUS] for the recording destination track. Then press PARAMETER [▶▶].
13. "Use EFFECT2?" appears in the display. Make settings for FX2 as described in steps 9 - 12, and press PARAMETER [▶▶].
14. If you wish to send the channel to the AUX bus, select either "Pre" or "Pst," and press PARAMETER [▶▶]. If you do not wish to send the channel to the AUX bus, select "Off," and press PARAMETER [▶▶].

EZR TR1 AUX Snd= Pst

- 14-1. Use the TIME/VALUE dial to adjust the AUX send level, and press PARAMETER [▶▶].
- 14-2. Use the TIME/VALUE dial to adjust the AUX send pan, and press PARAMETER [▶▶].
15. "Master Sel=" appears in the display. Use the TIME/VALUE dial to select the bus (MIX, AUX, FX1, FX2, REC) that you wish to output from the MASTER jacks. Then press PARAMETER [▶▶].

EZR Master Sel = MIX

16. "EQ Sel=" appears in the display. Rotate the TIME/VALUE dial, and press PARAMETER [▶▶].

EZR EQ Sel= 2BandEQ

17. "Direct Out =" appears in the display. If you do not wish to use Direct OUT, select "Off." If you wish to output tracks 1-4, select "1-4." If you wish to output tracks 5-8, select "5-8." Then press PARAMETER [▶▶].

EZR Direct Out = Off

18. "FX1 MstIns=" appears in the display. If you wish to insert FX1 into the master out, select "On." If not, select "Off." Then press PARAMETER [▶▶]. If FX1 has been inserted in another channel, the display will indicate "—" and this item cannot be set.

EZR FX1 MstIns = Off

19. "FX2 MstIns=" appears in the display. If you wish to insert FX2 into the master out, select "On." If not, select "Off." Then press PARAMETER [▶▶]. If FX2 has been inserted in another channel, the display will indicate "—" and this item cannot be set.

EZR FX2 MstIns = Off

20. "Change Routing?" appears in the display. Press [YES]. When the routing has been finalized, "Complete" appears in the display, and you will return to Play condition. If you decide to discard the routing that was set, press [NO].

Creating an Audio CD (CD-R Write)

This explains how a CD-R/-RW drive connected to the SCSI connector of the VS-880EX ver.2.0 can be used to create original audio CD's, or to back up song data. Please also read "Chapter 8 Use with a CD-RW Drive" in the VS-880EX Owner's Manual (p.107).

Creating silence between songs (Disc at Once and Track at Once)

When writing songs to a CD-R disc, you can select how the space between songs will be handled.

Disc at Once

The song data and the track number markers attached to the song data will be written to the CD-R disc without change. However, additional song data cannot be added later to a CD-R disc that was written using Disc At Once. (It will be in the same condition as if Finalize had been performed.)

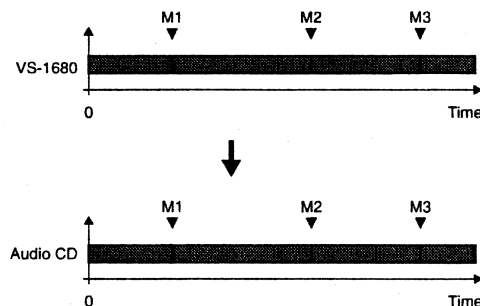

Track at Once

Two seconds of silence will automatically be written to the CD-R disc before each track number marker attached to the song data. (This is the same condition as when additional songs are written to the disc later.) Additional song data can be written to a CD-R disc that was written using Track at Once.

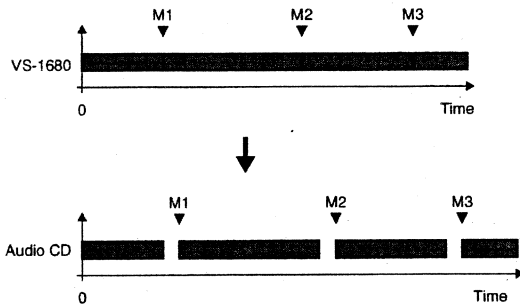

MEMO

For example, if you have assigned track numbers to a medley of songs, Disc At Once would be the appropriate choice. This is because Track At Once would add approximately two seconds of silence, which would cause the playback to sound fragmented.

NOTE

If you use the CD-RW disc, you cannot choose "Track at Once" upon writing.

Specifying the writing speed (Speed)

When writing songs to a CD-R disc, you can now select the speed at which the data will be written.

Song writing procedure

1. Place a blank CD-R disc in the CD-R/-RW drive.
2. Press [SONG] several times until "SNG CD-R Write?" appears in the display.
3. "STORE Current?" appears in the display. Press [YES] or [NO].
4. The VS-880EX displays the device ID number of the connected CD-R/-RW drive for a set time.
5. "Disc at Once?" or "Track at Once?" appears in the display. Press PARAMETER [◀◀] or [▶▶] to select how the data will be written, and press [YES].

Track at Once

Approximately two seconds of silence will be created between each song. Additional songs can be written later as far as the disc capacity allows.

Disc at Once

Silence will not be created between songs. However, no further data can be written on that disc.

- 5-1. If you select "Track at Once," press PARAMETER [◀◀] or [▶▶] to select whether or not the finalize is carried out, press [YES].

MEMO

A TOC (Table Of Contents) will be written so that the audio CD created by the VS-880EX Ver.2.0 can be played back on a standard CD player. It is not possible to write additional data to an audio CD that has been finalized.

Write w/o Fin. ?:

Write only the song, and do not finalize.

Write + Finalize:

Write the song, and then finalize.

Finalize:

Only finalize without writing the song. Select this if you have inserted a CD-R disc to which you have already written songs, but which has not yet been finalized.

6. Use CURSOR [◀] or [▶] and [SEL (CH EDIT)] to select the tracks on the CD-R disc to which you want the song written.
7. Press PARAMETER [▶▶]. "CD Speed" appears in the display. Use TIME/VALUE dial to select the speed at which the song will be written to the CD-R disc.

SNG CD Speed × 1

CD Speed

- x2: The song will be written at double speed.
- x1: The song will be written at normal speed. This will provide higher reliability.

NOTE

With some CD-R discs, the data may not be written correctly if you select "x2." In this case, select "x1." However, if a CD-RW disc is inserted into the CD-RW drive, it will not be possible to select "x1" (the song will be written at double speed).

MEMO

Audio data written to a CD-RW disc cannot be played back on a conventional CD player. In such cases, you can listen to the data using the VS-880EX's CD Player function.

8. Press PARAMETER [▶▶]. A confirmation message appears in the display.
9. Press [YES (ENTER)]. "SNG CD Track No. OK?" is displayed.
10. Press [YES]. "Obey Copyrights?" is displayed.
11. Carefully read the License Agreement (detailed on the back cover of this manual); if you agree to the terms, press [YES].
12. Writing to the CD-R disc begins. If you do not agree to the terms, press [NO]. The VS-880EX just returns to the condition at Step 2.
13. After the write procedure has been carried out normally, "Write Another?" appears in the display.
14. When you want to write the same song information to another CD-R disc, insert another disc in the CD-RW drive and press [YES]. Repeat Steps 10-14. Press [NO] to return to the condition at Step 2.

Saving a song to a CD-RW disc (CD-R Backup)

Checking whether the song was saved correctly (+Verify)

After backing up a song to a CD-RW disc, you can now check whether or not the data was saved correctly (i.e., check the recorded state of the data).

If as a result of the +Verify operation, you are warned that the song data has not been saved correctly, you should back up to a different disc.

MEMO

When backing up to a CD-R, we recommend that you use +Verify to check whether the backup was performed correctly. However, +Verify checks the entire surface of the disc, so it takes a considerable amount of time.

Specifying the speed of saving (Speed)

When backing up a song on a CD-RW disc, you can now specify the speed at which the data will be written.

VS-880EX Newly added functions (Ver.2.0)

Backup procedure

1. As the current drive, select the drive (internal IDE hard disk) that contains the song you wish to back up.
2. Insert a CD-RW disc into the CD-R/-RW drive.
3. Press [SONG] several times until "CD-R Backup ?" appears in the display.
4. Press [YES]. "STORE Current?" (Store the current song?) appears in the display.
5. If you wish to save the current song, press [YES]; if not, then press [NO]. If you have selected a demo song, then press [NO].
6. "CDR Bak=" appears in the display. Use the TIME/VALUE dial to select the song (only one song or all songs on the current drive) that you wish to save, and press PARAMETER [▶▶]. To backup all songs from the current drive, select "All."
7. "+Verify=" Rotate the TIME/VALUE dial, and press PARAMETER [▶▶].

SNG +Verify= On

+Verify

If this is turned "On," verification will be performed after the song data has been backed up, to check whether or not the data was saved correctly.

8. "CD Speed=" appears in the display. Rotate the TIME/VALUE dial.

SNG CD Speed × 1

CD Speed

Select the speed at which the song data will be backed up to the CD-RW disc

x2: Backup at double speed.

x1: Backup at normal speed. This will increase the reliability.



Depending on the disc, it may not be possible to back up reliably to a CD-R disc with a setting of "x2." In such cases, select "x1." Also, if you insert a CD-RW disc into a CD-RW drive, it will not be possible to select "x1" (backup will occur at double speed).

9. Press [YES].
10. If the song holds a large amount of data, and cannot be contained on a single CD-RW disc, the disc is ejected, and the message "Insert Disc #" (# indicates the number in the order of insertion) appears in the display to check the total amount of necessary discs. Insert the next CD-RW disc and press [YES]. At this time, we recommend that you write the disc numbers on the labels so that you can keep track of the order in which the discs were inserted into the drive.
11. When copying over multiple CD-RW discs, "Insert Disc #" (# indicates the number in the order of insertion) appears in the display. Insert each of the discs once more in the proper order and press [YES].
12. When the CD-R backup procedure is finished, return to Play condition.

Restoring songs from a CD-RW disc (CD-R Recover)

Specifying the speed of recovery (Speed)

Now you can specify the speed at which the data will be read when recovering a song from a CD-RW disc.

Recovery procedure

1. Select the disk (internal IDE hard disk) containing the song you want to load as the current drive.
2. Place the CD-R disc to which the song data has been backed up in the CD-R/-RW drive.
3. Press [SONG] several times until "CD-R Recover ?" appears in the display.
4. Press [YES]. "STORE Current?" (Store the current song?) appears in the display.
5. If you wish to save the current song, press [YES]; if not, then press [NO]. If you have selected a demo song, then press [NO].
6. "CDR Rcv=" appears in the display. Use the TIME/VALUE dial to select the song (only one song or all songs on the CD-RW disc) that you wish to load, and press PARAMETER [▶▶]. To recover all songs from the current drive, select "All."
7. "CD Speed=" appears in the display. Rotate the TIME/VALUE dial.

SNG CD Speed × 1

CD Speed

Select the speed at which the song data will be recovered from disc.

x6: Recover at 6x speed.

x2: Recover at double speed.

x1: Recover at normal speed. This will allow greater reliability.



Depending on the disc, it may not be possible to recover reliably from some CD-R discs at speeds of "x6" or "x2." In this case, select "x1." Even if the "CD Speed" is set to "x2" or "x6" the time it takes for recovery is not always 1/2 or 1/6 of the base. This is because writing to the internal hard disk can take a lot of time, or disc read errors can sometimes occur.

8. Press [YES].
9. If you selected "All" in step 6, the display will indicate "INIT ***: OK ?" (OK to initialize the disk drive?). "***:" is the ID number and partition number of the recover destination disk drive. For example when recovering to partition 0 of the internal hard disk drive, the display would indicate "IDE:0."
10. If you wish to initialize the current drive and then recover, press [YES]. If at this point you press [YES], all songs saved on the internal hard disk will be lost. If you decide not to initialize, press [NO]. Normally you should press [NO].
11. Execute the load. When over multiple discs, the disc is ejected, "Insert Disc #" (# indicates the number in the order of insertion) appears in the display. Insert the next disc and press [YES].
12. When the CD-R recover procedure is finished, return to Play condition.

To Update the VS-880EX

There are several ways in which the new functions can be added to the VS-880EX. Please read the section that applies to your VS-880EX.

You can use the VS-880EX 2.0 system program Zip disk to add the VS-880EX 2.0 functionality to your VS-880EX.

Prepare the following items.

- VS-880EX
- SCSI Zip drive
- VS-880EX 2.0 system program Zip disk

MEMO

After you have upgraded the VS-880EX, you can continue using the hard disk that you are currently using without any changes. It is not necessary to initialize the hard disk. However, as a precaution against unforeseen accidents, we recommend that you back up your song data before performing the upgrade.

NOTE

The VS-880EX 2.0 system program Zip disk contains a program which installs the software update. Be careful not to initialize it on the VS-880EX.

1. Make sure that the power is turned off on all devices.

NOTE

To prevent malfunction and/or damage to speakers or other devices, always turn down the volume, and turn off the power on all devices before making any connections.

2. Disconnect all cables that were connected to the VS-880EX.
3. Connect the SCSI Zip drive to the VS-880EX. On the back of the Zip drive, make sure the termination switch is set to 'on'.

NOTE

Have only the SCSI Zip drive connected. Do not connect any other disk drives.

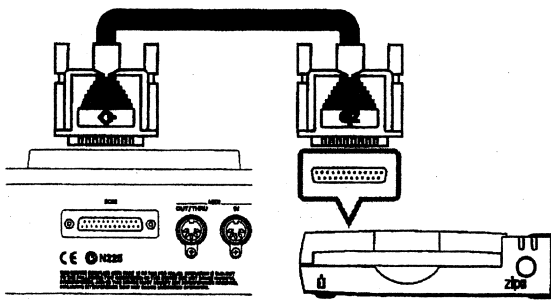

4. Turn on the power of the SCSI zip drive.
5. Insert the VS-880EX 2.0 system program Zip disk into the SCSI Zip drive.
6. Connect the power cable to the VS-880EX.
7. Turn on the rear panel power switch of the VS-880EX.

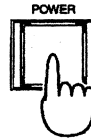

8. Wait for the display to prompt "Update System Program?" and then press [YES].

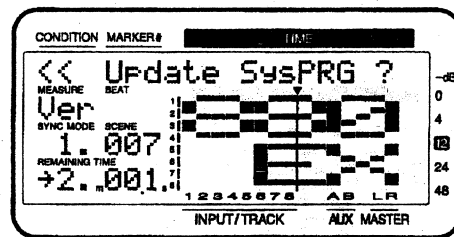

MEMO

If this display does not appear, the VS-880EX was not able to recognize the Zip disk. Turn off the power, re-insert the disk correctly, and turn the power on once again.

9. A message will ask whether you wish to keep the user settings that are stored in your VS-880EX. Press [YES] and proceed to step 11. If you wish to initialize (erase) the user settings, press [NO], and proceed to step 10.

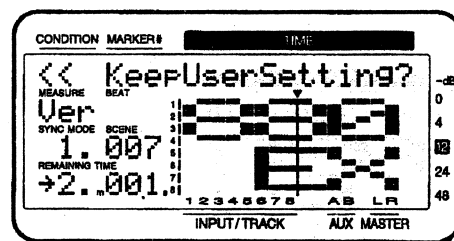

The user settings that can be left in the VS-880EX are as follows.

- Effect user patches (VS-880EX Owner's Manual, p. 70)
- Easy routing (VS-880EX Owner's Manual, p. 74)

(please turn over...)

To Update the VS-880EX

10. If you pressed [NO] in step 9, an additional message will ask you to confirm. If you wish to erase (initialize) the user settings, press [YES]. If you press [NO] you will return to step 9.

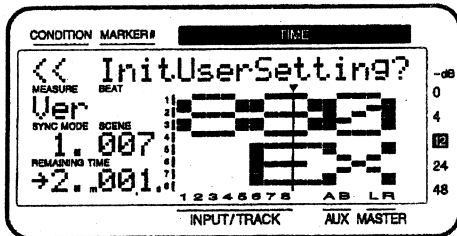

11. The expansion procedure will begin. Please wait for approximately 30 seconds.

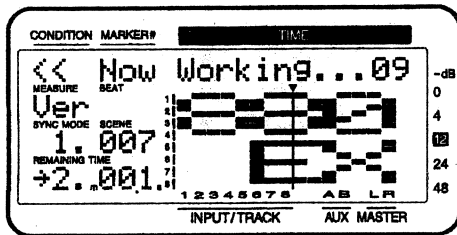

You must never under any circumstances turn off the power until the function expansion procedure has been completed. Doing so could damage the VS-880EX system.

12. Once the following message appears, you may turn off the power. Verify that this message has appeared, and then turn off the rear panel power switch.

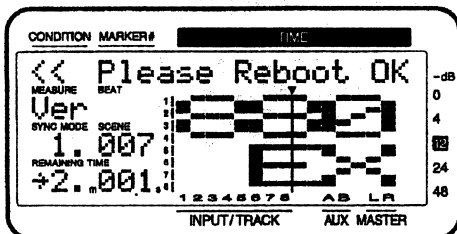

13. Turn on the power once again. Verify on the display that the system software is now 2.00 or higher.

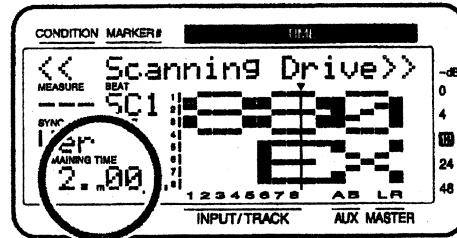

Subsequently, when starting up the VS-880EX, you will not need the VS-880EX 2.0 system program Zip disk. Keep this Zip disk in a safe location that is not excessively warm. The VS-880EX 2.0 system program Zip disk cannot be used on any device other than the VS-880EX.

* Zip is a trademark of Iomega Corporation.

Roland®

17048446

UPC

17048446



1898:

Roland