



 Roland®

W-30

Owner's Manual

	CAUTION RISK OF ELECTRIC SHOCK DO NOT OPEN	
ATTENTION: RISQUE DE CHOC ELECTRIQUE NE PAS OUVRIR		
CAUTION: TO REDUCE THE RISK OF ELECTRIC SHOCK, DO NOT REMOVE COVER (OR BACK) NO USER-SERVICEABLE PARTS INSIDE. REFER SERVICING TO QUALIFIED SERVICE PERSONNEL.		



The lightning flash with arrowhead symbol, within an equilateral triangle, is intended to alert the user to the presence of un-insulated "dangerous voltage" within the product's enclosure that may be of sufficient magnitude to constitute a risk of electric shock to persons.



The exclamation point within an equilateral triangle is intended to alert the user to the presence of important operating and maintenance (servicing) instructions in the literature accompanying the product.

INSTRUCTIONS PERTAINING TO A RISK OF FIRE, ELECTRIC SHOCK, OR INJURY TO PERSONS.

IMPORTANT SAFETY INSTRUCTIONS

WARNING — When using electric products, basic precautions should always be followed, including the following:

1. Read all the instructions before using the product.
2. Do not use this product near water — for example, near a bathtub, washbowl, kitchen sink, in a wet basement, or near a swimming pool, or the like.
3. This product should be used only with a cart or stand that is recommended by the manufacturer.
4. This product, either alone or in combination with an amplifier and headphones or speakers, may be capable of producing sound levels that could cause permanent hearing loss. Do not operate for a long period of time at a high volume level or at a level that is uncomfortable. If you experience any hearing loss or ringing in the ears, you should consult an audiologist.
5. The product should be located so that its location or position does not interfere with its proper ventilation.
6. The product should be located away from heat sources such as radiators, heat registers, or other products that produce heat.
7. The product should avoid using in where it may be effected by dust.
8. The product should be connected to a power supply only of the type described in the operating instructions or as marked on the product.
9. The power-supply cord of the product should be unplugged from the outlet when left unused for a long period of time.
10. Do not tread on the power-supply cord.
11. Do not pull the cord but hold the plug when unplugging.
12. When setting up with any other instruments, the procedure should be followed in accordance with instruction manual.
13. Care should be taken so that objects do not fall and liquids are not spilled into the enclosure through openings.
14. The product should be serviced by qualified service personnel when:
 - A. The power-supply cord or the plug has been damaged; or
 - B. Objects have fallen, or liquid has been spilled into the product; or
 - C. The product has been exposed to rain; or
 - D. The product does not appear to operate normally or exhibits a marked change in performance; or
 - E. The product has been dropped, or the enclosure damaged.
15. Do not attempt to service the product beyond that described in the user-maintenance instructions. All other servicing should be referred to qualified service personnel.

SAVE THESE INSTRUCTIONS

WARNING: THIS APPARATUS MUST BE EARTHED.

For the U.K.

IMPORTANT: THE WIRES IN THIS MAINS LEAD ARE COLOURED IN ACCORDANCE WITH THE FOLLOWING CODE.
GREEN-AND-YELLOW: EARTH, BLUE: NEUTRAL, BROWN: LIVE

As the colours of the wires in the mains lead of this apparatus may not correspond with the coloured markings identifying the terminals in your plug, proceed as follows:

The wire which is coloured GREEN-AND-YELLOW must be connected to the terminal in the plug which is marked by the letter E or by the safety earth symbol  or coloured GREEN or GREEN-AND-YELLOW.

The wire which is coloured BLUE must be connected to the terminal which is marked with the letter N or coloured BLACK.

The wire which is coloured BROWN must be connected to the terminal which is marked with the letter L or coloured RED.

The product which is equipped with a THREE-WIRE GROUNDING TYPE AC PLUG must be grounded.

Copyright © 1989 by ROLAND CORPORATION

All rights reserved. No part of this publication may be reproduced in any form without the written permission of ROLAND CORPORATION.

W-30 Mode Chart for FD

Performance Mode

PERFORMANCE [1. Performance]

Sound Mode

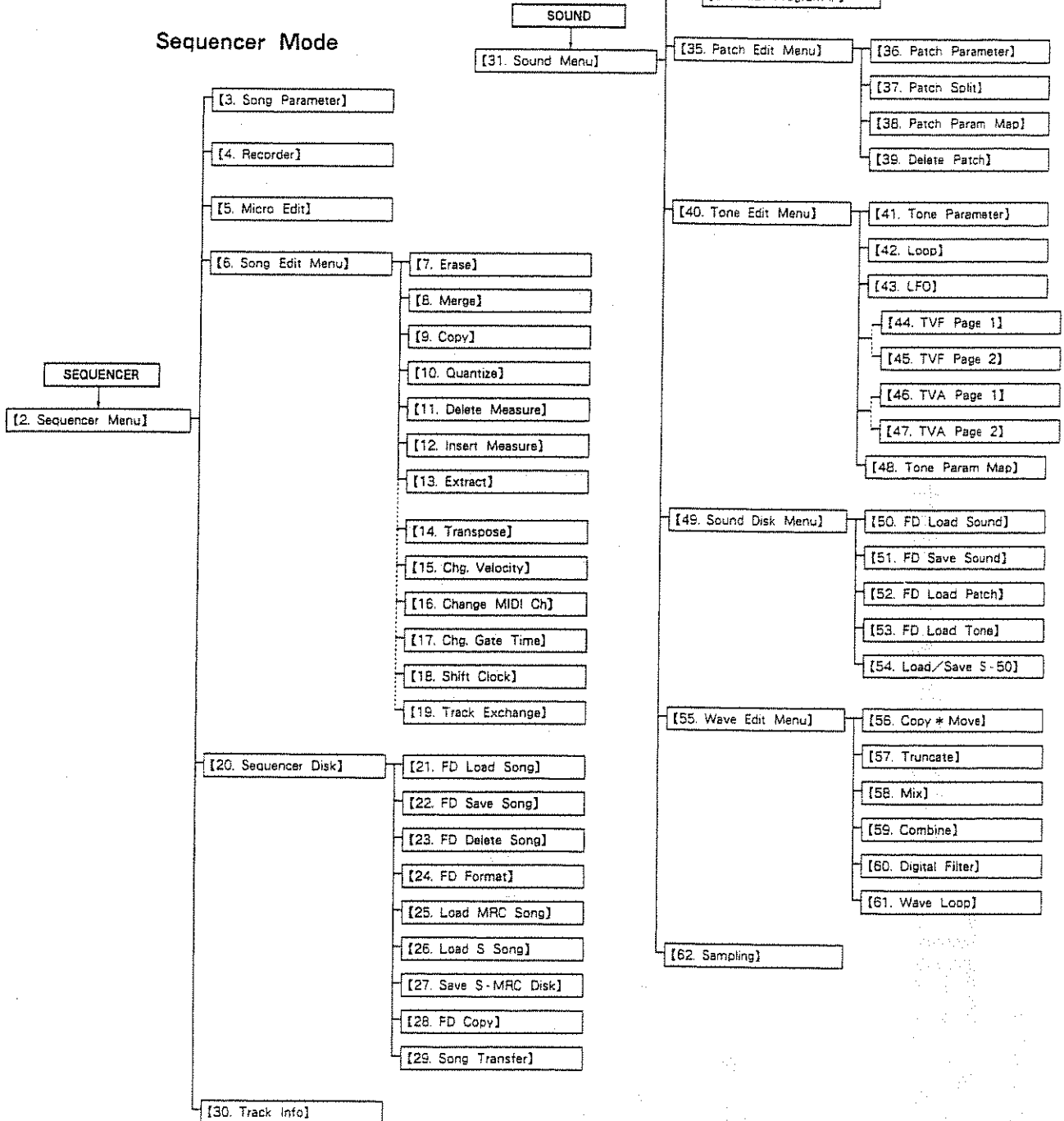

W-30 MIDI Flow Chart

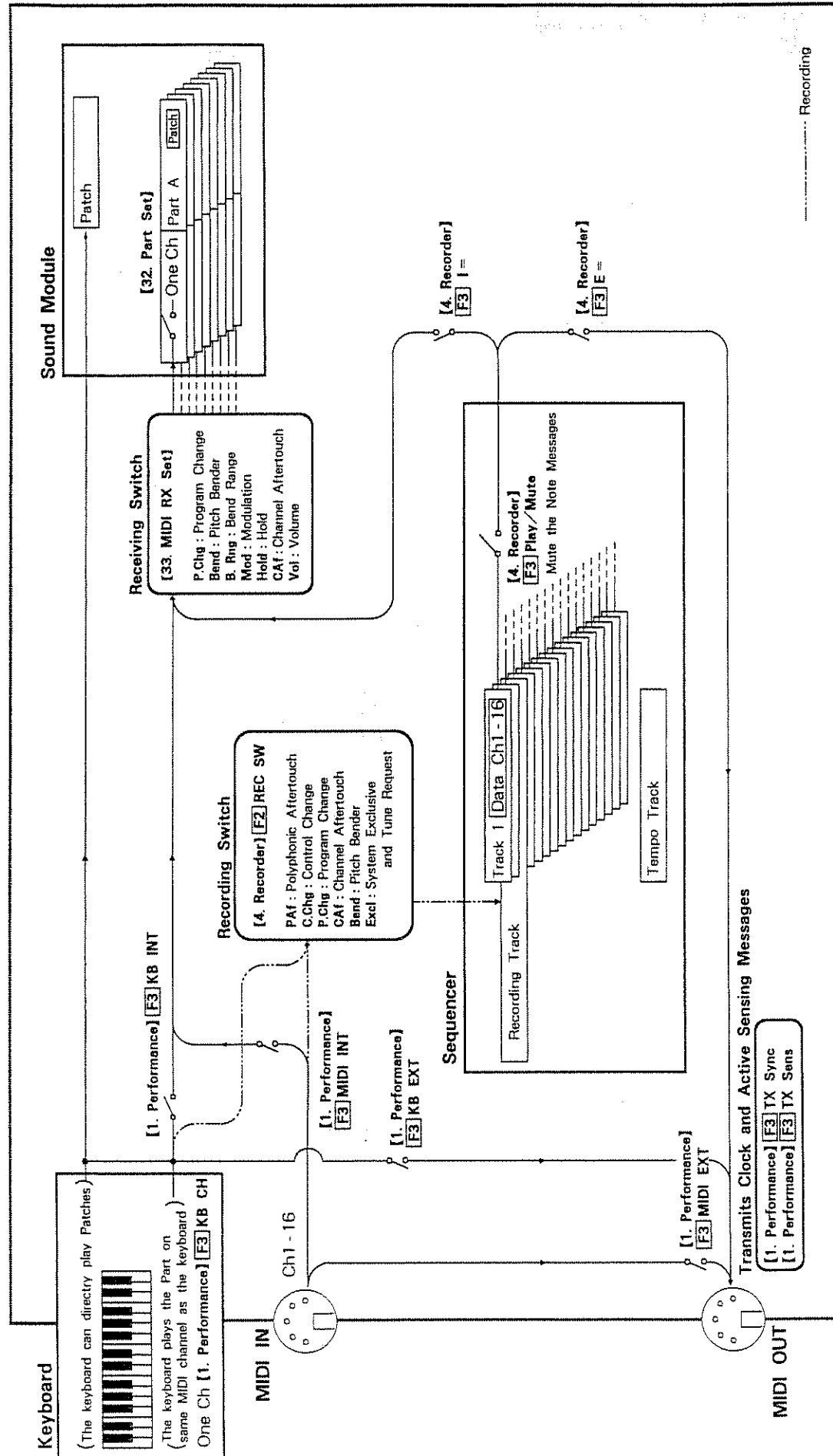

W-30 Sound Chart

■ Tone Parameters on the System Disk

No.	Tone Name	ROM Wave	Start point	End point
T. 1	LMK 1	A	0	3384
T. 2	Room K1	A	182848	191549
T. 3	Elk 1	B	0	9340
T. 4	hazkack	A	3385	18283
T. 5	Mach srl	A	155694	162812
T. 6	Mach srl2	A	148728	155693
T. 7	stroom1	A	182813	182845
T. 8	stroom2	A	182813	182845
T. 9	stroom3	B	9341	25213
T. 10	Verb Srt	B	25214	49534
T. 11	sidetrk	B	49535	63359
T. 12	Srs rim	A	134172	135692
T. 13	RoomTone1	A	182834	38466
T. 14	RoomTone2	A	242631	281063
T. 15	DvTone 1	A	191550	212758
T. 16	DvTone 2	A	191550	212758
T. 17	hihat-OP	B	63360	87935
T. 18	hihat-CL	B	63702	78731
T. 19	crash 1	A	38605	7487
T. 20	conga-HH	A	111488	118890
T. 21	conga-LO	A	118881	131100
T. 22	congcaMUT	A	218889	221889
T. 23	cabasa1	A	131101	133402
T. 24	clave 1	A	133403	134171
T. 25	convball1	A	139593	141884
T. 26	apogo-HH	A	212759	218898
T. 27	apogo-LO	A	212759	218898
T. 28	tamb 1	A	221800	227859
T. 29	clap 908	A	141885	145725
T. 30	808bbl1	A	227859	236574
T. 31	808bbl1	A	236574	239039
T. 32	808sdl1	A	239039	242630

Tones represented with are loaded at startup. To load other tones, carry out the Load Tone procedure. See page 75 in the W-30 for FD Owner's Manual.

☐のトーンは、起動時にロードされます。その他のトーンをロードするには、ローファクトリーの機能を使います。W-30 for FD オナーズ・マニュアルのP.75をご覧ください。

No.	Tone Name	ROM Wave	Start point	End point
T. 33	Slap 3A	B	81379	100882
T. 34	Slap 3B	B	100887	109757
T. 35	Pop 1	B	109842	121784
T. 36	Thumb 01	B	121785	143144
T. 37	Slap 01	B	143145	169384
T. 38	Slap 02	B	169385	171904
T. 39	Flase 1	B	171905	177058
T. 40	Flase 2	B	177059	189320
T. 41	Flase 3	B	189321	194900
T. 42	Flase 4	B	194901	198633
T. 43	Mediba 1	B	198634	205304
T. 44	Mediba 2	B	205305	211555
T. 45	Mediba 3	B	211556	224089
T. 46	Mediba 4	B	224090	228985
T. 47	Suprbst1	B	228986	234072
T. 48	Ethano 1	B	234073	238949
T. 49	Ethano 2	B	238950	242758
T. 50	stroomPAD	B	251237	259762
T. 51	Jx10-1	B	237274	251236
T. 52	saw1	B	88758	88749
T. 53	saw2	B	88759	89494
T. 54	square 1	B	89495	90651
T. 55	square 2	B	90652	91334
T. 56	Apolo 1	A	212758	213196
T. 57	ReverTone	A	14928	38590
T. 58	snRvrt1	B	25214	48534
T. 59	gongola	A	38581	74871
T. 60	tamb 2	A	222014	227154
T. 61	Fat K1	B	0	9340
T. 62	RoomTone3	A	182834	38466
T. 63	Dvntone1	A	182834	38466
T. 64	Picob S	A	3385	18233
T. 65	Gungo 1	A	41186	42958
T. 66	EP Pad 1	B	230000	233615

No.	Tone Name	ROM Wave	Start point	End point
T. 67	Jkpad 1	B	240342	251236
T. 68	stringS5	B	87936	88749
T. 69	stringS1	B	88750	88484
T. 70	stringS2	B	87936	88749
T. 71	stringS3	B	87936	88749
T. 72	stringS4	B	88750	88484
T. 73	svnmmer1	B	253091	259762
T. 74	svnmmer2	B	253091	259762
T. 75	cow tak	A	238518	251236
T. 76	Jx10-1	B	238519	251236
T. 77	Clear 1	B	240342	244885
T. 78	Clear 2	B	224160	224885
T. 79	Clear 3	B	238519	251236
T. 80	Clear 4	B	224160	224885
T. 81	synBRS 1	B	87936	88749
T. 82	synBRS 2	B	87936	88749
T. 83	synPLY 1	B	87936	88749
T. 84	synPLY 2	B	87936	88749
T. 85	synMUT 1	A	41288	42754
T. 86	synMUT 2	A	41288	42754
T. 87	SNPAD A	B	89495	90651
T. 88	SNPAD B	B	89495	90651
T. 89	MINI 1B	B	208810	217592
T. 90	Clear 1	B	225642	226727
T. 91	Clear 2	B	225642	226727
T. 92	sterncho	B	253091	259762
T. 93	Pulse A	A	261532	261659
T. 94	Pulse B	A	261532	261659
T. 95	Pulse C	A	261532	261773
T. 96	Pulse D	A	261532	261773

No.	Tone Name	ROM Wave	Start point	End point
T. 97	Pulse E	A	261780	262001
T. 98	Pulse G	A	261532	261773
T. 99	synPLY 3	B	87936	88749
T. 100	synPLY 4	B	87936	88749
T. 101	synPLY 5	B	87936	88749
T. 102	synPLY 6	B	87936	88749
T. 103	Clear 5	B	234571	234707
T. 104	Clear 6	B	234571	234707
T. 105	sawPAD 1	B	87936	88749
T. 106	sawPAD 2	B	87936	88749
T. 107	synBASS2	B	87936	88749
T. 108	synBASS3	B	220456	220883
T. 109	synBASS4	B	198882	203541
T. 110	PeroSyn1	B	220570	220686
T. 111	PeroSyn2	A	74926	75044
T. 112	PeroSyn3	B	236022	236534
T. 113	PeroSyn4	B	220911	220983
T. 114	PeroSyn5	B	236758	240752
T. 115	Junobs 1	B	260075	260545
T. 116	Junobs 2	B	260075	260545
T. 117	synZRezt1	B	231929	250980
T. 118	synZRezt2	B	237314	250980
T. 119	synS1 1	B	87936	88749
T. 120	synS1bha	B	251600	259762
T. 121	Slap 1	B	237044	237273
T. 122	PulseGut	A	261659	261857
T. 123	94.7	A	245692	260699
T. 124	RetTone1	A	242291	261001
T. 125	Melohorn	B	88750	89494
T. 126	Wild 1A	B	236244	239609
T. 127	# 9	A	215098	235163
T. 128	Midnight	A	222052	227639

■ Patches on the System Disk

No.	Patch Name
P. 1	Drums/Perc
P. 2	Gongoclar 1
P. 3	Slap Bass 1
P. 4	Slap Bass 2
P. 5	Slap Bass 3
P. 6	Fretless Bal
P. 7	Fretless Bst2
P. 8	FretlessBass
P. 9	Syn Bass 1
P. 10	Syn Bass 2
P. 11	Syn Bass 3
P. 12	E Piano
P. 13	Steamer
P. 14	Synth Lead 1
P. 15	Poly Synth 2
P. 16	Comb - Shing
P. 17	Shing Pad
P. 18	ArhhgStng
P. 19	SteamSynth
P. 20	JX-10 Synth
P. 21	Metal Cows
P. 22	Cosmos Juno
P. 23	Waveola 1
P. 24	JX-10 rezo
P. 25	Synth Brass1
P. 26	Poly Synth 1
P. 27	Waveola 2
P. 28	Hollow Pad
P. 29	Synhass Bvb
P. 30	Waveola 3
P. 31	Steamechras
P. 32	Ogilano

Patches represented with are loaded at startup. To load other patches, carry out the Load Patch procedure. See page 76 in the W-30 for FD Owner's Manual.

☐のパッチは、起動時にロードされます。その他のパッチをロードするには、ローファクトリーの機能を使います。W-30 for FD オナーズ・マニュアルのP.76をご覧ください。

W-30 Sound Chart

ROM Wave Information

ROM Wave	Loop	Start Point	Loop Point	End Point
Wave A	1 Shot	0	0	3384
Wave A-1	1 Shot	3385	3385	18233
Wave A-2	1 Shot	18234	18234	30485
Wave A-3	1 Shot	30486	30486	74871
Wave A-4	1 Shot	74872	105290	111485
Wave A-5	1 Shot	111486	117092	118980
Wave A-6	1 Shot	118981	130157	131100
Wave A-7	1 Shot	131101	131101	133402
Wave A-8	1 Shot	133403	133403	134172
Wave A-9	1 Shot	134173	134172	135693
Wave A-10	1 Shot	135694	141685	145725
Wave A-11	1 Shot	145726	145726	155694
Wave A-12	1 Shot	155695	155694	182845
Wave A-13	1 Shot	182846	182846	191549
Wave A-14	1 Shot	191550	191550	212758
Wave A-15	1 Shot	212759	212759	218998
Wave A-16	1 Shot	218999	218999	221899
Wave A-17	1 Shot	221900	221900	227868
Wave A-18	1 Shot	227869	227869	236573
Wave A-19	1 Shot	236574	236574	239038
Wave A-20	1 Shot	239039	239039	242630
Wave A-21	1 Shot	242631	242631	251063
Wave A-22	1 Shot	251064	251077	251531
Wave A-23	1 Shot	251532	251545	251859
Wave A-24	1 Shot	251860	251873	251730
Wave A-25	1 Shot	251731	251744	251801
Wave A-26	1 Shot	251802	251815	251928
Wave A-27	1 Shot	251929	251943	252067
Wave B	1 Shot	0	0	9340
Wave B-1	1 Shot	9341	9341	25213
Wave B-2	1 Shot	25214	25214	49534
Wave B-3	1 Shot	49535	49535	63359
Wave B-4	1 Shot	63360	63360	87935
Wave B-5	1 Shot	87936	88021	88749
Wave B-6	1 Shot	88750	88793	89484
Wave B-7	1 Shot	89485	89500	90551
Wave B-8	1 Shot	90552	90558	91334
Wave B-9	1 Shot	91335	98707	100982
Wave B-10	1 Shot	100983	108759	109841
Wave B-11	1 Shot	109842	119649	121784
Wave B-12	1 Shot	121785	139474	143144
Wave B-13	1 Shot	143145	162896	166984
Wave B-14	1 Shot	166985	170452	171804
Wave B-15	1 Shot	171805	175545	177382
Wave B-16	1 Shot	177383	189243	189319
Wave B-17	1 Shot	189320	194327	194900
Wave B-18	1 Shot	194901	198417	198633
Wave B-19	1 Shot	198634	206868	208695
Wave B-20	1 Shot	208697	217592	220488
Wave B-21	1 Shot	220489	224232	224693
Wave B-22	1 Shot	224694	232895	233615
Wave B-23	1 Shot	233616	237044	237273
Wave B-24	1 Shot	237274	241894	251238
Wave B-25	1 Shot	251239	253492	258782
Wave B-26	1 Shot	258783	259776	260003
Wave B-27	1 Shot	260004	260017	260074
Wave B-28	1 Shot	260018	260088	260545
Wave B-29	1 Shot	260546	260585	260747
Wave B-30	1 Shot	260748	260801	260956
Wave B-31	1 Shot	260957	260972	260928
Wave B-32	1 Shot	260973	260983	261000
Wave B-33	1 Shot	261001	261014	261469
Wave B-34	1 Shot	261470	261483	261711
Wave B-35	1 Shot	261712	261725	261782
Wave B-36	1 Shot	261726	261796	261853
Wave B-37	1 Shot	261854	261867	261924

W-30 Songs on the Data Disks

Data Disk 1

Song Name	Music and copyright 1989 by: Adrian Scott	No.	Patch Name
Pay special attention to the tonal quality of the acoustic guitar. Its sound is created with such reality that you can hear even the hammer-ons and sliding sounds during chord changes. Sounds such as these have been sampled separately from those of the strings. (You can call up patch P1, P2 and play it to hear better what we mean.)	ギターとピアノの音の質に特別な注意を払って下さい。アコースティックギターは、ハンマリングやスライドなどの音も弦の音と一緒にサンプリングされています。(P1, P2の音を呼び出して聞いてみるのがわかりやすい。)	P 1	Acou - Guitar
At the high point within the piece a woman can be heard singing gently. This is an example of phrase sampling, a technique available only with samplers.	曲の最高点で、女性がやさしい歌声が入ります。これはフレーズサンプリングを使ってサンプリングされた音です。	P 2	Guit - Hammer
		P 3	Penny
		P 4	StringsSynth
		P 5	Drums/Perc
		P 6	Drums/Bass
		P 7	E Piano

Data Disk 2

Song Name	Music and copyright 1989 by: Amin Bharia	No.	Patch Name
This virtuous, light-hearted piece was created using everyday sounds sampled in an office environment. Many sounds are present: such as that of a rubber band strummed with a finger, papers being stapled, tape pulled out, typewriter, coffee percolating or simple laughter. Using the W-30's sampling capabilities, you might want to try your hand at creating other pieces along this line.	この元気で、軽快な曲は、オフィスで録音された日常の音で構成されています。指でゴムバンドを弾く音、ペーパーを綴じる音、テープを引っ張る音、タイプライター、コーヒーポット、笑い声など、さまざまな音が使われています。W-30のサンプリング機能を使って、このような曲を作ってみてください。	P 1	All Tones
		P 2	Pitched
		P 3	One Shot FX
		P 4	Long FX
		P 5	Perc Loops
		P 6	Pitched 2
		P 7	Drums/Perc
		P 8	Slap Bass 1
		P 9	Drums/Bass
		P 10	FingerBass
		P 11	E Piano

Data Disk 3

Song Name	Music by: M. Sakane Ideas (c) 1989 by Roland	No.	Patch Name
This song features a fast-like piano trio. The expression you hear from piano is thrilling enough to make you forget that a sequencer is even involved. The piano sounds used are the same realistic sounds that found archaic with the S-301 System 1.	この曲は、疾走感のあるピアノトリオを特徴としています。ピアノの音は、シーケンサーが関わっているにもかかわらず、驚くべきほどリアルな印象を与えます。この曲には、S-301システム1で収録された、非常にリアルなピアノの音を使用しています。	P 1	Ac Piano
		P 2	Bright Piano
		P 3	Forte Piano
		P 4	Mellow Piano
		P 5	Honky - tonk 1
		P 6	Honky - tonk 2
		P 7	Honky - tonk 3
		P 8	FingerBass
		P 9	Drums/Perc

Connect a cable between the I (MIX) jack on the W-30 and an input jack on your external device, such as an amp. Leave the Output Mode at "Mix" for listening to these songs.

W-30のI (MIX) ジャックと外部デバイスの入力ジャックをケーブルで接続し、Output ModeはMIXのままお聞きください。

Thank you, and congratulations on your purchase of the Roland W-30 Music Workstation. The W-30 is a comprehensive package combining sequencer, sampler, and keyboard controller. Taken individually, each module has been designed to be of a quality equivalent to that of upper-range models. By having full use over such a combination, you are assured a greater range of freedom, and a higher quality of sound with the creations that you make.

FEATURES

Superior Operational Ease

A new level of operating ease has been achieved with the W-30 through employment of a large LCD display, and an operating system that provides for the quick, easy call up of data, and smooth editing changes.

High Class MIDI Sequencer

The W-30 incorporates a high class multi-track MIDI sequencer that provides a wealth of editing functions. It also features 16 track multi-recording, and can store up to 20 songs or approx. 15,000 notes in its internal memory.

DI Process Digital Sampler

The W-30 is also equipped with a high quality Roland DI Process digital sampler. It features an expanded range of sound parameters, supported by efficient editing functions. You are thus able to sample most any sound, your own voice or any desired sound.

Large Memory Capacity

The internal memory of the W-30 is stocked with a great volume of Roland's high quality wave data, already widely employed by many recording studios; and has 128 different preset tones that use such wave data. You can select up to 64 of these preset tones, and then can add up to 32 original sounds or tones provided on optional sound libraries, making a total of 96 tones that you are able to use simultaneously.

Sound creation can be done while playing back the sequencer

The W-30 not only allows you to program a song while having independent, direct control over play of the sound module, but you can also have the sequencer play-back while performing edits on a sound. Many other ways of working can be accommodated, such as playing the same note repeatedly in order to edit a sound.

61-key Keyboard

The W-30's 61-key keyboard is provided with velocity and aftertouch sensitivity, so changes in tone or volume can be obtained depending on the force of a keypress, or the amount of pressure maintained after playing a key.

S and MC Series data can be used

The W-30 can read and use sound data from the S-550, S-330, or S-50, and sequence data created with SYS-553, SYS-333, SYS-503, MRC-500, MRC-300 and SUPER-MRC.

Hard Disk and CD-5 can be connected

Through connection of a hard disk, a much greater volume of song and sound data can be stored, and retrieved and transferred at much higher speeds. The Roland CD-5 CD-ROM Player provides access to any desired sound from the enormous selection available on CD-ROM discs (L-CD1 supplied with CD-5, USV-1 Compact Disc for CD-ROM by Optical Media). To connect a hard disk or CD-5, you will need the optional unit, KW-30 (W-30 Upgrade Kit).

CONTENTS

FEATURES	3
PANEL DESCRIPTION	5
IMPORTANT NOTES	7
About This Manual	8

Chapter One First Steps Playing the W-30

1. CONNECTIONS	10
2. DISKS SUPPLIED	11
3. POWER-UP AND BOOTING UP	12
4. BACKING UP THE SYSTEM DISK	13
5. PERFORMANCE PLAY	14
6. SEQUENCER PLAY	17

Chapter Two An Overview

1. W-30's Three Functions	20
2. Sequencer	21
3. About Sound Data	26
4. Interrelation of Functions	34
5. About the System	37
6. Memory	38

Chapter Three Operating the W-30

1. The W-30's Operation Modes	44
2. Basic Procedures	45

Chapter Four A Functional Guide

1. To Change Volume	52
2. To Change Output Sockets	53
3. To Change the Number of Voices of Each Part	54
4. To Change Pitches	55
5. To Change Patches	56
6. To Create Sound Data	58
a. Making a Patch	58
b. Editing Tone Parameters	60
c. Editing Wave Data	70
d. Loading Sound Data from a disk	72
e. Sampling	77
7. Writing a Song	81
a. Recording	81
b. Re-recording portions of data	88
c. Micro Editing	92
d. Writing Tempo Change	94
e. Song Editing	95
f. Check of the Song Data	97

8. Saving Data onto a Disk	98
9. Pedal Control (Pedal Assignment)	99
10. Using data created on other models on the W-30	100
11. Converting W-30 data for other models	101
12. Using External MIDI Devices	102
a. To play an external sound module connected to the MIDI-OUT socket	102
b. Using a MIDI Controller connected to MIDI IN	103
c. Sync to External MIDI Device	104
d. Recording while Synchronized to an External MIDI Sequencer	105
13. Other Functions	106
a. Saving System Configuration Data	106
b. Formatting a Floppy Disk	106
c. Copying a Floppy Disk	107

Chapter Five Screen Functions

1. PERFORMANCE MODE	110
2. SEQUENCER MODE	113
3. SOUND MODE	144

Chapter Six Reference

1. Table of Data saved onto disks	184
2. Error and Other Messages	187
3. Troubleshooting	188

Roland Exclusive Messages	192
About W-30 Exclusive Messages	195
MIDI Implementation Chart	196
MIDI Implementation	198

SPECIFICATIONS	200
Index	202

PANEL DESCRIPTION

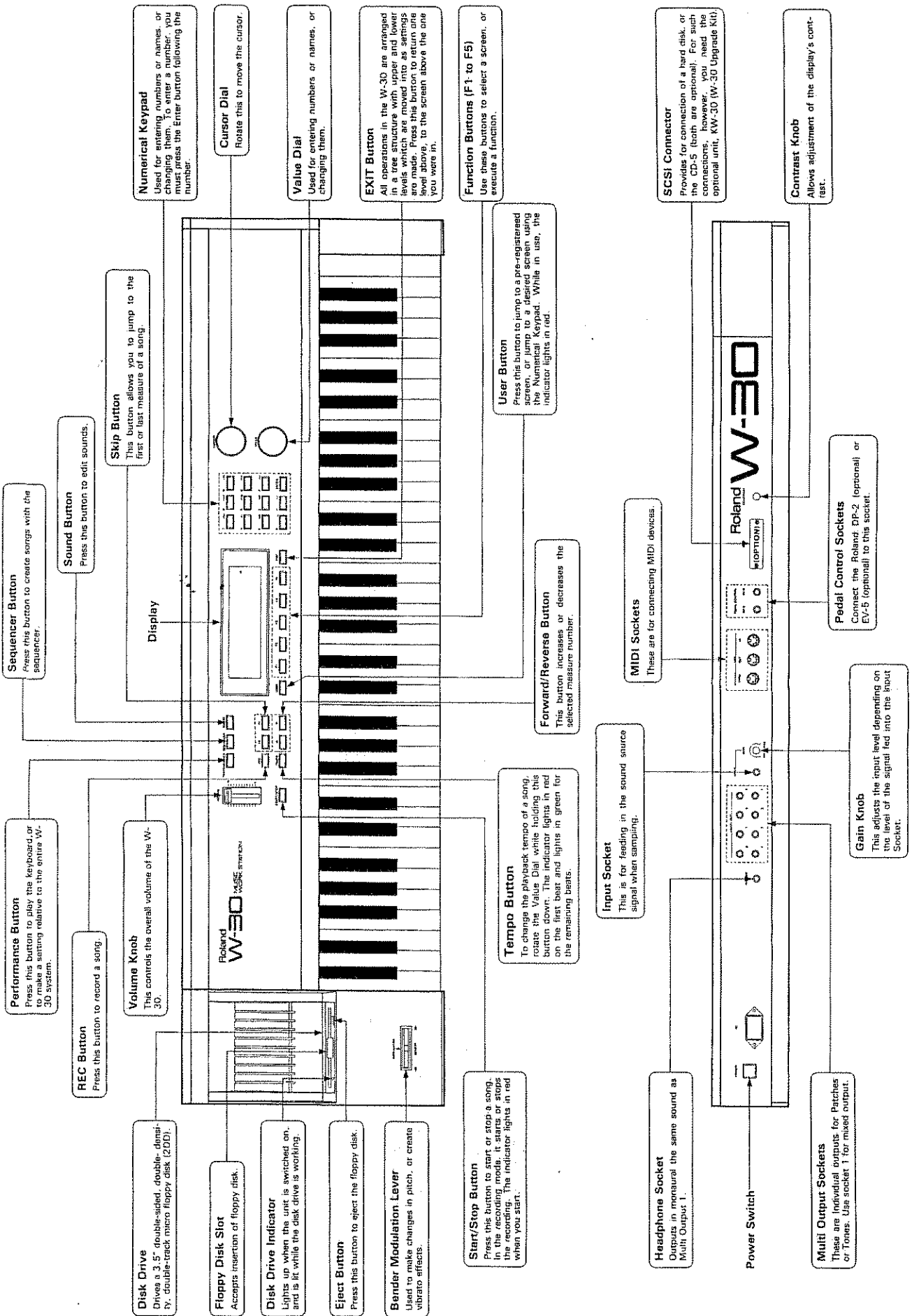

IMPORTANT NOTES

In addition to the items listed under Safety Precautions, on page 2, we request that you please read and adhere to the following.

Concerning the power supply

- Whenever you make any connections with other devices, always turn off the power to all equipment first. This will help in preventing malfunction, and damage to speakers.
- Do not force the unit to share the same power outlet as one used for distortion producing devices (such as motors, variable lighting devices). Be sure to use a separate power outlet.

Concerning placement

- Placing the unit near power amplifiers or other equipment containing large transformers may induce hum.
- Should the unit be operated nearby television or radio receivers, TV pictures may show signs of interference, and static might be heard on radios. In such cases, move the unit out of proximity with such devices.
- Most everyone has noticed the moisture that forms on the windows of heated rooms in winter. This moisture, or condensation, can form in your disk drive in situations such as the following:
 - When a room has been heated up suddenly.
 - When left in a place where humidity is high.
 - When moved to a warm place after having being stored in a colder place.In such situations, not only may operation be unreliable, but the drive as well as data on disks may be damaged. You should wait for about an hour before using it.
- Place the unit so that it is level, well-supported, and unaffected by external vibrations. If placed at a steep angle, the operation of the disk drive may be adversely affected. (Tolerable angles: upward, 0 degrees, downward 20 degrees)

Maintenance

- For everyday cleaning, wipe the unit with a soft dry cloth, or one that is dampened slightly. To remove dirt that is more stubborn, wipe using a mild, neutral detergent. Afterwards, make sure to wipe thoroughly with a soft cloth.
- Never apply benzene, thinners, alcohol or any like agents, to avoid the risk of discoloration and deformation.

Other Precautions

- Protect the unit from strong impact.
- Never apply strong pressure to the display, or strike it in any way.
- A certain small amount of heat or sound may be radiated or heard from the unit, and thus should not be considered abnormal.
- Before using the unit in a foreign country, check first with your local Roland Service Station.
- Never remove a disk while the disk drive is operating (while its indicator is lit). Otherwise, the disk's magnetic surface can be damaged, rendering it unfit for further use.
- Remove any disks from the disk drive when turning power to the unit off or on.

Handling of disks

- Disks consist of a film-like substance onto which a magnetic coating has been applied. Since this surface is called upon to store data with precision at a very high density, please follow the following precautions:
 - Never touch the magnetic surface.
 - Never store disks where exposed to direct sunlight, or in strictly confined environments, such as the interior of an automobile. (Allowable temperature range: 5 to 50 ° C.)
 - Do not allow disks to come near strong magnetic fields, such as that generated by speakers.
- Disks are provided with a protect tab which can be used to protect data from accidental erasure. It is recommended that you keep the tab at the protect position, and move it only when you need to write data to the disk.

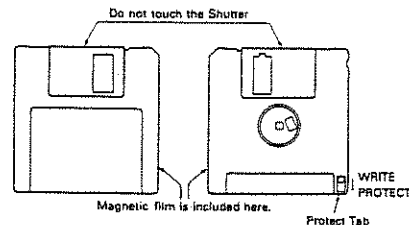

• To prevent accidental loss of data, be sure to set the Protect Tab to the PROTECT position except when writing (recording) data.

- All important data should be backed up onto copies to protect from the advent of unforeseeable loss.
- Disk labels should be affixed properly. If they come loose within the drive, the disk may be very difficult to remove.

About This Manual

This manual is organized as shown below. Each chapter should be referred to as necessary.

- | | |
|----------------------|--|
| Chapter One | First Steps – Playing the W-30
Preparation and play of the keyboard and sequencer. |
| Chapter Two | An Overview
Getting a good understanding of how the W-30 is organized. |
| Chapter Three | Operating the W-30
Learning mode and screen organization. |
| Chapter Four | A Functional Guide
The sequences of steps you should perform, arranged according to what you have in mind for sound and song creation. |
| Chapter Five | Screen Functions
A screen by screen explanation of functions. |
| Chapter Six | Reference
Parameter Classification Chart, Troubleshooting, MIDI Implementation, Index. |

A hard disk (Apple Computer Inc., CMS Inc.), or the CD-5 (optionally available) can be connected for use with the W-30. To accomplish this you will need the optional KW-30 (W-30 Upgrade Kit).

Contact the retailer where you purchased the W-30 for information on purchase of this kit.

When using a hard disk or the CD-5 refer first to the "W-30 Owner's Manual for FD, CD, & HD", supplied with the KW-30.



Chapter One

First Steps-Playing the W-30

Preparation and play of the keyboard and sequencer.

1. CONNECTIONS

As a start, you will most likely want to listen to the W-30. You first need to connect an amplifier such as a keyboard amplifier, or headphones.

Before making any connections, make sure that all units are switched off.

Amplifier Setup

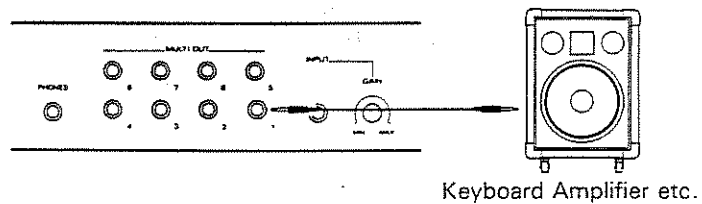

Setup Using Radio Cassette Recorder, etc.

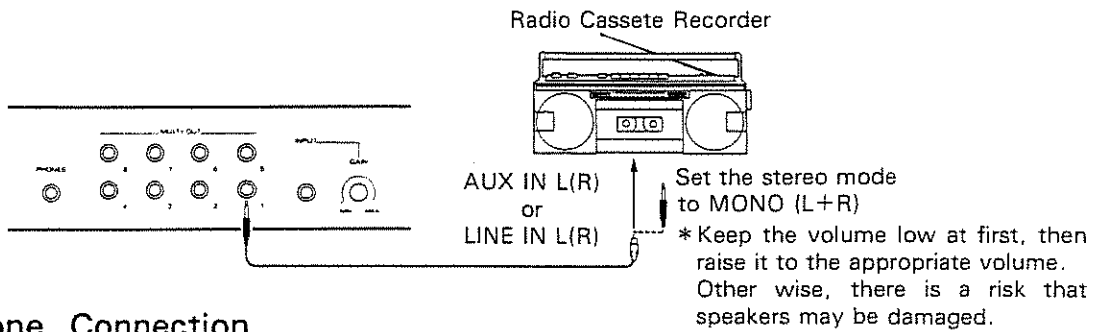

Headphone Connection

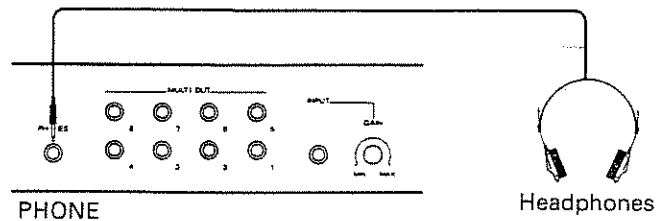

Mixer Setup

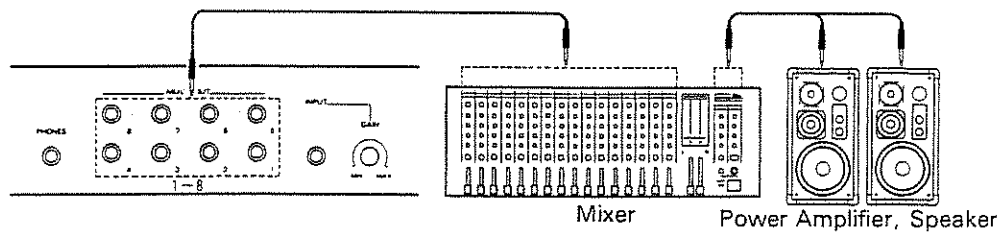

*To output sounds separately from the 8 Multi Output Sockets, set the "Output Mode" in [32. Part Set] to "Multi". (See page 53.)

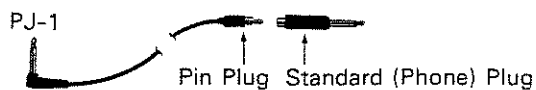

2. DISKS SUPPLIED

The W-30 is supplied with four disks ; a system disk and three data disks containing sounds and song demo samples.

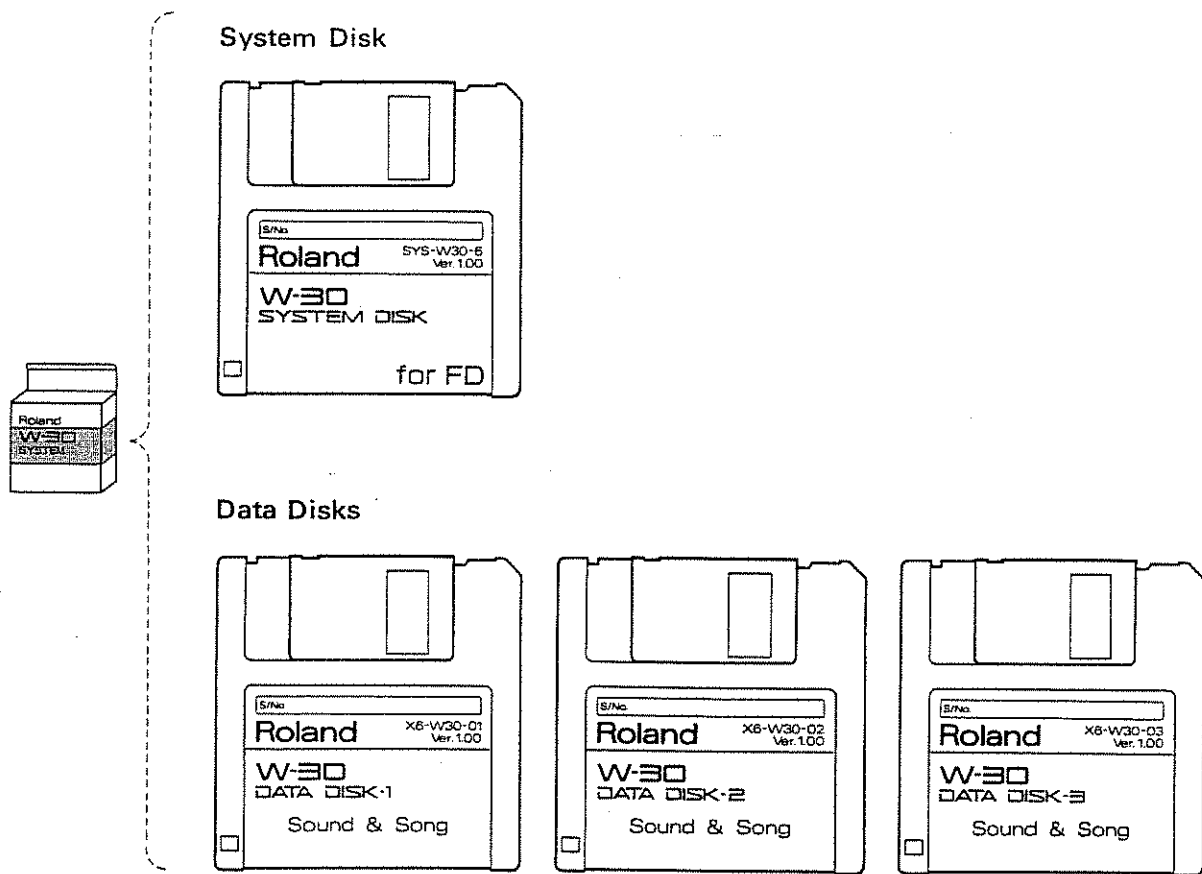

3. POWER-UP AND BOOTING UP

To activate the W-30, it is necessary to boot it up with the supplied system disk which contains the programs necessary for operating it.

- ① Before switching on the W-30, check the following :
 - Have all the necessary connections been properly made?
 - Is the disk drive empty?
 - Is the volume of the amplifier turned down?

- ② Set the power switch on the rear of the unit to ON.

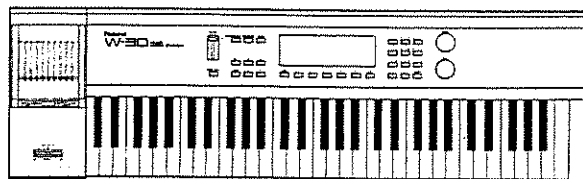
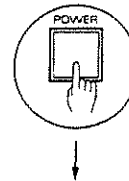

- ③ Insert the system disk into the Disk Drive. It should click into place.

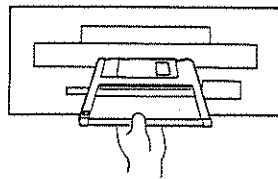

After the system programs needed to operate the W-30 have completed loading, the display responds as shown below :

```
1. Performance STOP
Patch P 1 Drums/Perc Level 127
P 1 Drums/Perc      P 5 Fretless Bs1
P 2 Slap Bass 1    P 6 Fretless Bs2
P 3 Slap Bass 2    P 7 FingeredBass
P 4 Slap Bass 3    P 8 Syn Bass 1
M. Tune | P.PRM | Conf 191 | Conf 192 | --
```

- ④ Switch on the amplifier.

The internal sounds of the W-30 can now be played from the keyboard.

*When you switch off the units, first switch the amplifier off, then the W-30.

4. BACKING UP THE SYSTEM DISK

Now that you've heard some of the sounds available with your keyboard, before going any further, let us remind you to be sure to make a backup of your system program.

Any floppy disk will tend to wear out eventually through continued use. Since the system program is highly important, you should put it away for safekeeping, and use copies instead.

*Please use Roland MF2-DD disks (double-sided, double-density, double-track 3.5" micro-floppy disks).

*Do not remove the system disk until the message "Insert New Disk" appears.

*Caution : If you have sound or song data already loaded in the unit, and then make a backup, you will lose the data in memory, since it is erased in order to make backups.

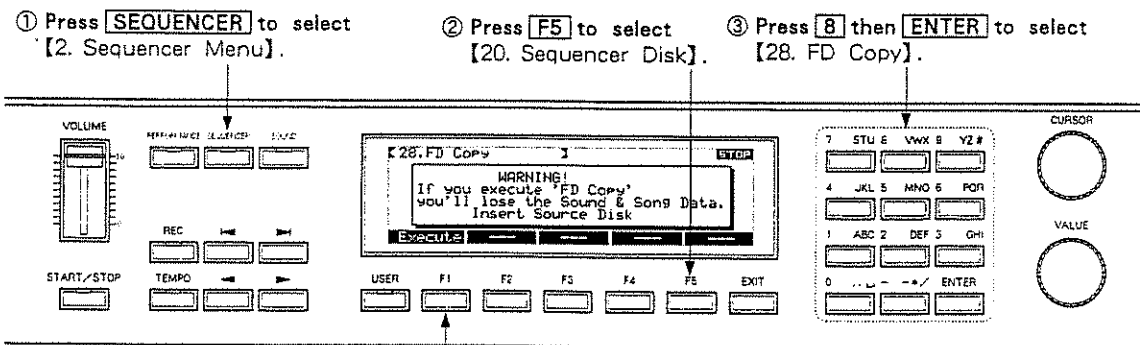

④ Press [F1] and wait.

When the message "Insert New Disk" appears, remove the system disk.

Set the Protect Tab on a new disk to the WRITE position, then insert it into the disk drive.

⑤ Press [F1] and wait.

When the copy has been completed, the message "Complete" appears.

*Any of the other W-30's disks can be backed-up as well, using the above procedure. (see page 107.)

5. PERFORMANCE PLAY

You're now ready to play the W-30.

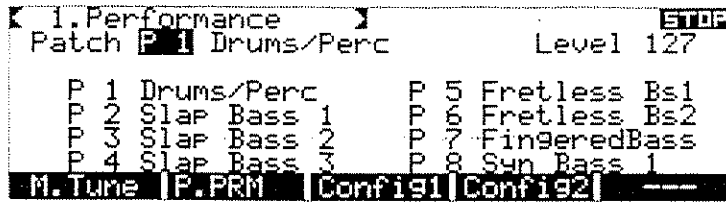

* If the above display is not visible, press **PERFORMANCE**.

Play the keyboard.

Shown on the second line in the display is the note (Patch) currently being played.

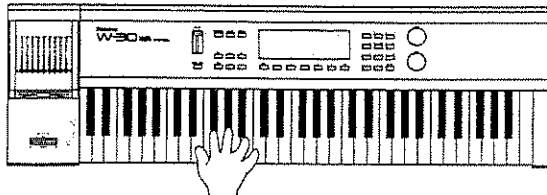

Changing Patches

The W-30 has 16 Patches, P1 to P16.

The display will first show the Patch List for P1 through P8.

Rotating the VALUE dial will call patches up in sequence, changing the sounds.

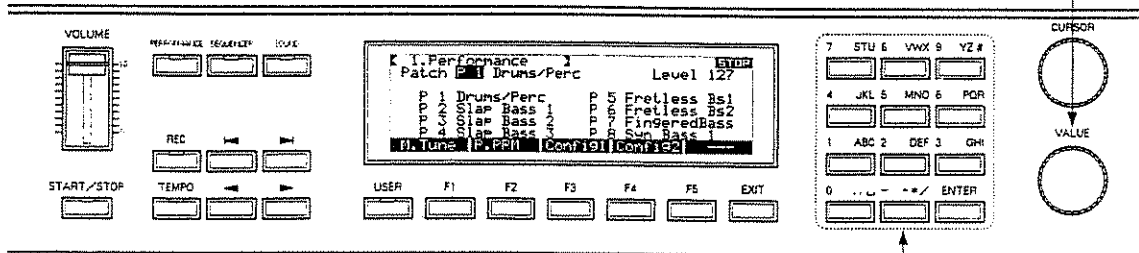

You can also make selection of patches with the numerical keypad (press relevant numbered key (s), then **ENTER**). For instance, to select patch 15, press **1**, **5**, then **ENTER**.

* When patches are changed using the Value dial or the keypad, the displayed listing changes as well.

Velocity

The volume or tone of a sound can be changed depending on how hard you play the keyboard (**velocity**). How to change the tone by velocity value is set for each Patch or Tone. (See page 52,59,148,161,163.)

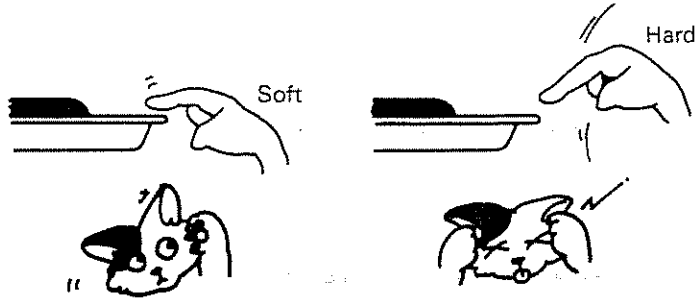

Aftertouch

Aftertouch is the effect caused on the volume, pitch or tone by pressing a key down harder after the normal playing stroke. The aftertouch assignment and its value is set for each patch. (See page 150.)

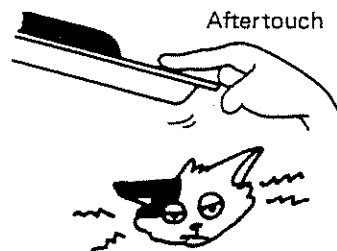

Using the Bender Modulation Lever

While playing the keyboard, if you shift the Bender Modulation Lever to the left, the pitch will be lowered, and if you shift it to the right the pitch will rise. Since the pitch change is smooth, it can be used for expressing subtle pitch changes such as the sliding effect on a string-type instrument.

The maximum pitch change caused by fully bending the lever is set for each Patch. (See page 16,110,149.)

Pushing the Bender Modulation Lever forward will give you a vibrato effect. The vibrato depth caused by pushing the lever is set for System Configuration. (See page 37,111.)

You can obtain the above two effects at the same time, and thus richer expression, by pushing the lever forward while bending to the right or left.

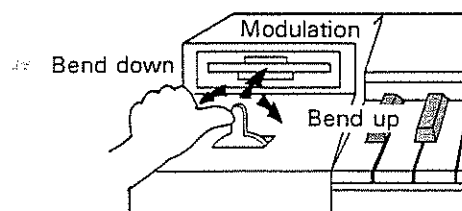

Bend Range

Allows for adjustment of the Bend Range (amount of pitch change occurring when the Bender Lever is moved to its extreme). Settings are made in semitone units; ranging from 0 (no effect) up to 12 (1 octave).

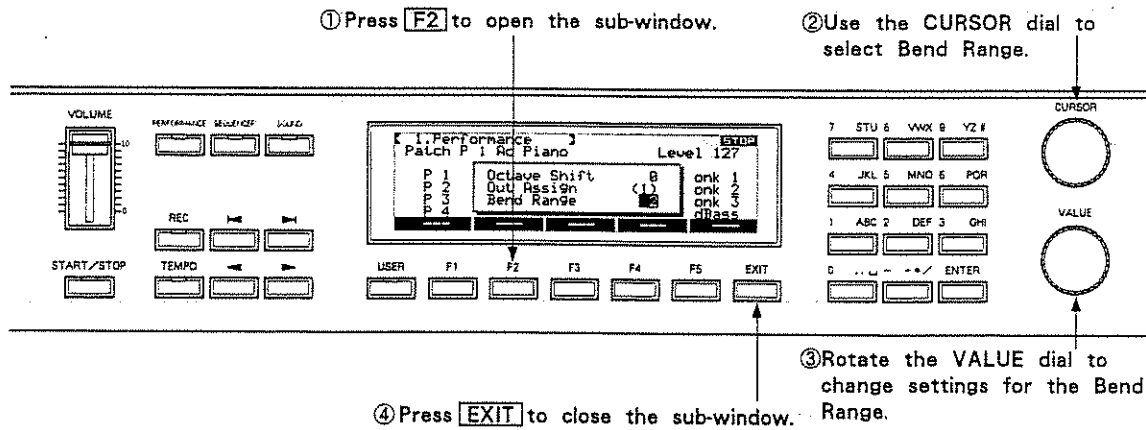

Master Tuning

This function controls the overall tuning of the W-30. From -64 to +63 are valid as settings. (At zero, the pitch set in the tone parameters, is obtained.)

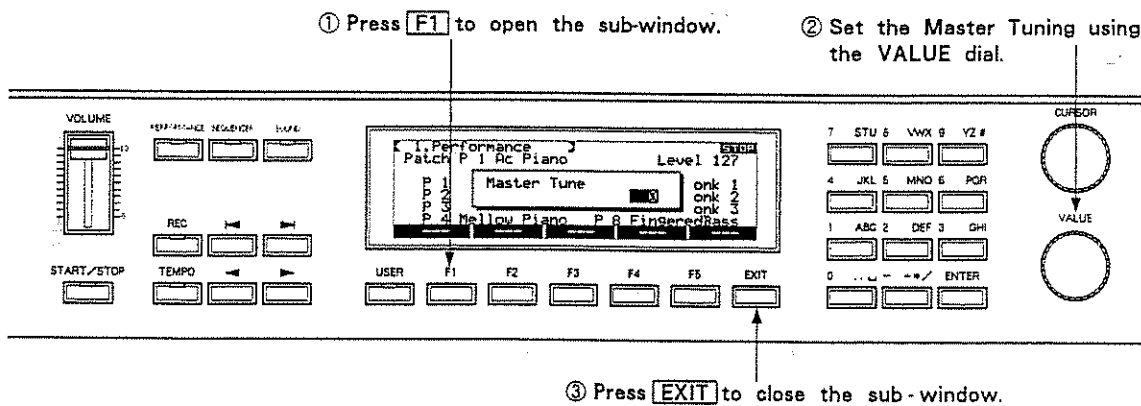

6. SEQUENCER PLAY

Now, let's play the W-30 with the sequencer.

Three data disks are supplied to play the W-30. Each disk contains song data and the sound data (the W-30's sounds) needed to play the song. Choose one of the three data disks for loading into the W-30.

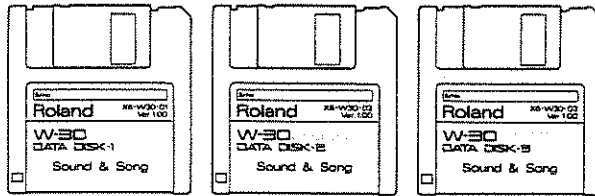

Loading Song Data and Sound Data

① Press the Eject button to remove the system disk from the disk drive.

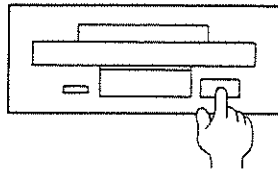

② Insert a data disk into the disk drive.

③ Press **SEQUENCER** to select [2. Sequencer Menu].

④ Press **F5** to select [20. Sequencer Disk].

⑤ Press **F1** and wait until [21. FD Load Song] appears.

⑥ Press **F2** (+ Sound) to start loading.

When loading has completed, the message "Complete" appears.

With this, the necessary sound data and song data has been loaded from the data disk.

Song Play

Try playing the song you have loaded.

① Press **SEQUENCER** to select [2. Sequencer Menu].

② Press **F2** to select [4. Recorder].

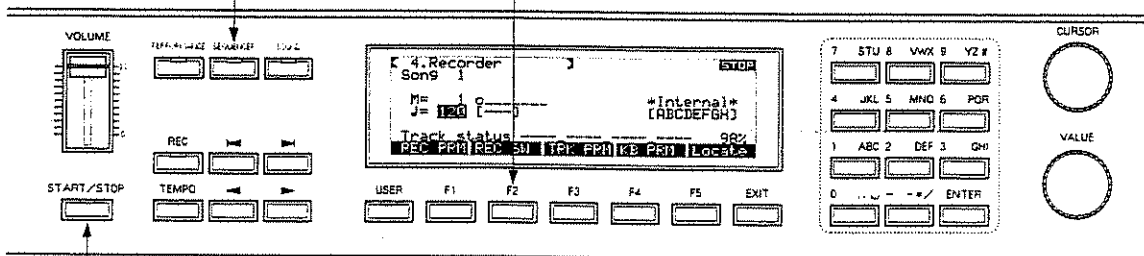

③ Press **START/STOP** to play the song.
To stop playing, press **START/STOP** again.

Indicates each Part, inverted when Note messages are received.

M= 10 C
J= 94 [124]

Standard Tempo made, the current tempo is shown.

Track status PP-M--RP-M-- 98%

Track 1
Appears every fourth track

Track 16
The "-" mark indicates an empty track.

P represents the track played, M represents Mute, and R represents the track being recorded.

The capacity of the internal memory remaining for song data. At 0%, no more data can be recorded.

The O mark moves to show the timing.

Internal [ABCDEFGH]

STOP at the upper right corner of the display indicates that a song is not playing, **PLAY** shows that the song is playing and **REC** shows that a song is ready to be recorded.

*In all other screens as well, **STOP** means that a song is ready to be played.

Changing the Tempo

The tempo of the song currently playing can be changed.

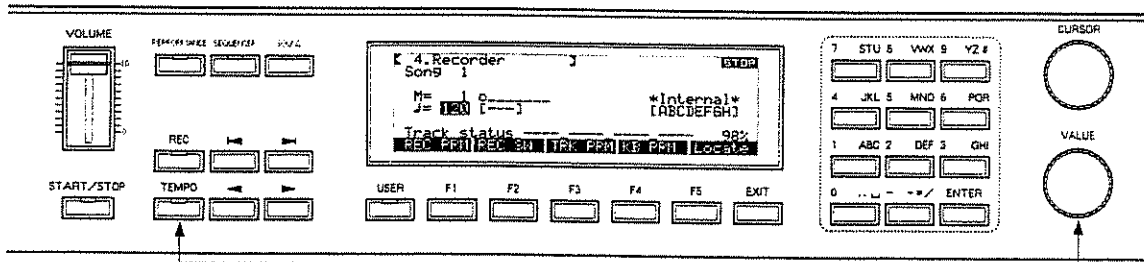

Rotate the **VALUE** dial while holding **TEMPO** down to change the standard tempo
The **TEMPO** Indicator lights in red at the first beat, and green for the remainder of the beats.

Playing along with the Song

The W-30 allows you to play the keyboard along with songs played by the sequencer.

① Press **PERFORMANCE** to select the [1. Performance] screen, then play the keyboard. (See Performance Play on page 14.)

*The maximum number of voices that the W-30 can play simultaneously is 16. In the [1. Performance] mode, if the total number of the voices used by sequencing, plus those played on the keyboard exceeds 16, the keyboard will be given priority. Please be aware that in such cases some sequencer sounds may be left out.



Chapter Two

An Overview

Getting a good understanding of how
the Web is organized.

1. W-30's Three Functions

The W-30 incorporates three sections, keyboard, sequencer and sound module.

Three Functions

●KEYBOARD

This section can be used for playing the sound module or for recording sequences.

●SEQUENCER

This section is used for recording signals received from the keyboard, or for playing the sound module.

●SOUND MODULE

This section produces the sounds; when played from the keyboard, or by the sequencer.

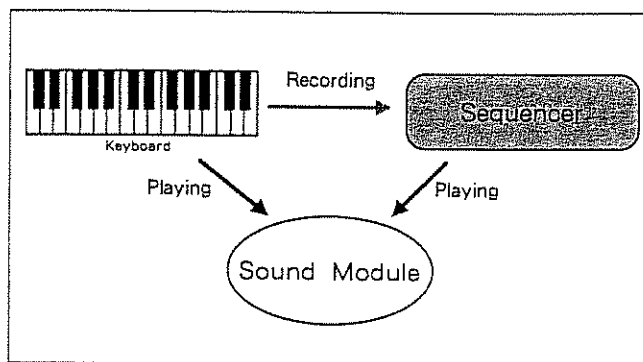

MIDI

All three sections can be considered as connected via MIDI. MIDI is an international interface standard that allows instruments to communicate with each other. To familiarize yourself further with the W-30, you should get some understanding of what MIDI is. Please read the separate booklet, "Guide book for MIDI".

2. Sequencer

Data programmed in the sequencer section is called **SONG DATA**.

Difference between a Sequencer and a Multi-track Recorder

A sequencer and a multi-track recorder can be thought of as being used in similar ways. Both have a number of tracks which you can record onto separately, and can layer sounds onto by dubbing over what is recorded. You can create a performance part by part. For instance, you might record a drum performance, then record bass to go with the drum data, then finally piano, to create a piano trio.

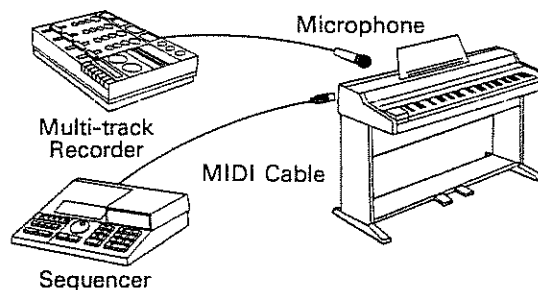

However, a sequencer is in other ways quite different from a multi-track recorder. A tape recorder uses a microphone to record "sounds played during performance", while a sequencer records "events occurring during performance" (such as which note, when, how strong, for how long; or when and how the bender modulation lever was moved, etc.) in the form of digital data, or MIDI messages. When MIDI data recorded on a sequencer is played back, it then plays the musical instrument (s), without you having to do so.

Feature of a Sequencer

A Sequencer has the following features :

- ① Mistakes you have made on the keyboard can be easily corrected. Even individual notes of a chord can be corrected.
- ② Changing tempos does not affect the pitch of the sound.
- ③ Any sound can be freely changed. For example, when you have recorded using a piano sound, it can be played back as an organ.
- ④ There is no crosstalk (sound on other tracks being faintly heard).
- ⑤ There is no deterioration in sound quality.

How to use a sequencer

Normally, a song is created in the following order.

●RECORDING

A song is recorded from the keyboard, or by playing a MIDI device connected to the MIDI IN socket.

●EDITING

You can re-record portions of the recorded data, make changes in all the data, or rewrite a step at a time.

●PLAYING

Recorded, and edited song data is played back.

●SAVING

Completed song data should be saved onto floppy disk. If not saved, any data contained in internal memory will be erased when the unit is switched off.

●LOADING

Data saved on a floppy disk can be loaded back to the W-30 for playing or editing.

Tracks

The W-30 allows you to make songs with 16 Phrase Tracks and one Tempo Track.

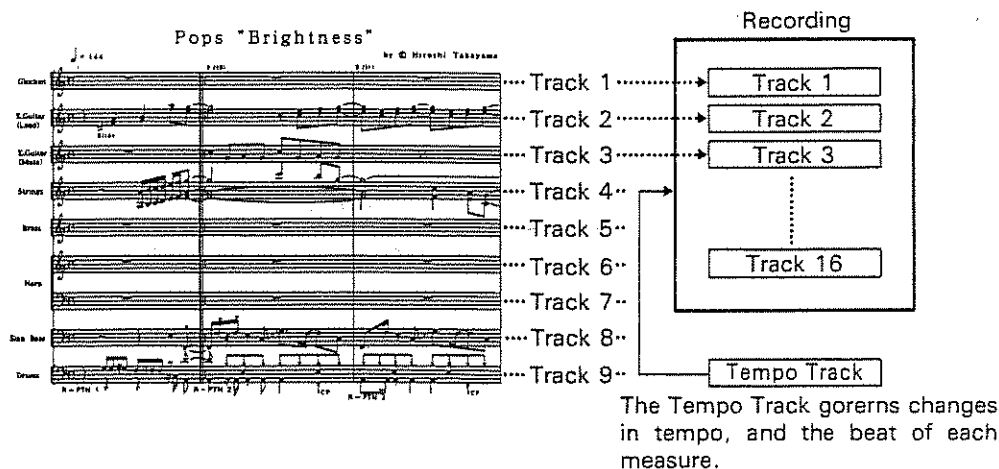

Phrase Tracks (Tracks 1 to 16)

Phrase Tracks store information on performance data, such as which instrument (MIDI channel) is played, when, which note, how strong, its duration, etc.

If you use each Phrase Track for recording information for a particular instrument (MIDI channel), the data for a certain instrument alone can later be edited, or can be listened to in solo.

Since a Phrase Track is also capable of recording the data of channels 1 to 16 as one congruent whole, after making edits for each instrument, you can merge (mix) the data for all the instruments onto one track (see page 121).

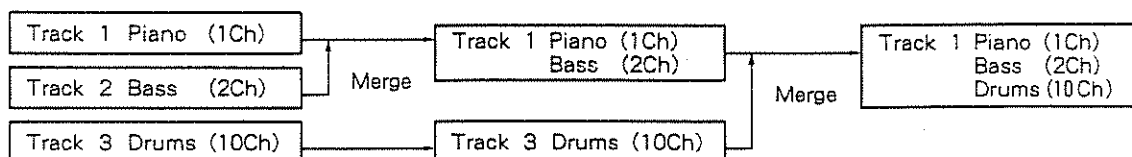

Tempo Track

The Tempo Track governs changes in tempo, and the beat of each measure.

Data concerning changes in tempo is stored in terms of "how fast/how slow compared to standard tempo", in the Micro Edit screen.

(see page 94,119)

* Tempo change data cannot be put in memory during recording.

Standard Tempo

The standard tempo is the basic tempo for a song. You can quicken or slow down the song by changing the standard tempo, yet there will be no change in the pitch.

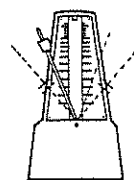

$\text{♩} = 60$ quarter notes per minute

Memory Capacity for Song Data

The W-30's memory can store up to 20 different songs.

The memory capacity of the W-30 is approx. 15,000 steps (about 15,000 single notes).

One song can store up to 9,998 measures. (see page 40.)

*1 step is equal to 1 line in the [5. Micro Edit] screen. (Except for Exclusive data.)

Getting a better look at the data

Let's see how a song is displayed in the sequencer.

① Press **SEQUENCER** to select [2. Sequencer Menu].

② Press **F3** to select [5. Micro Edit]. Data in Track 1 is displayed.

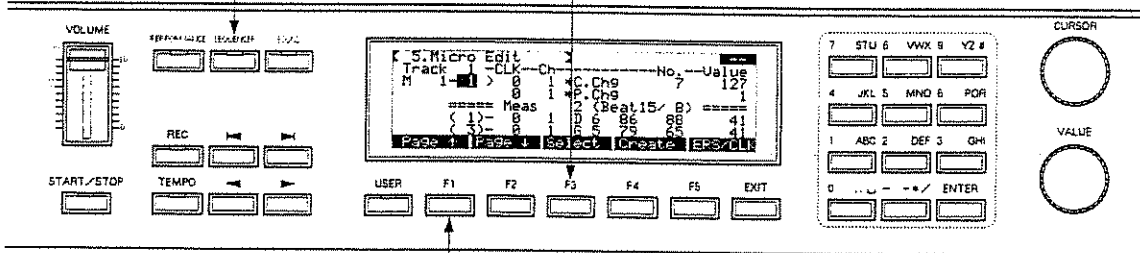

③ Press **F1** to move up, and **F2** to move down.

Select a track.

Move the cursor here and rotate the Value dial, and measures move up or down.

Move the cursor here and rotate the Value dial, and events move up or down.

Track	1	2	3	4	5	6	7	8	9	10
M	1	2	3	4	5	6	7	8	9	10
	20	53	53	10						
	1	1	1	1						
	E	C	C	C						
	5	4	5	5						
	76	60	72	72						
	58	56	71	64						
	40	45	35	49						
	==== Meas 2 (Beat 4/4) =====									
	(1) -	10	1	C	5	72	64	49		

Move the cursor here and rotate the Value dial, and beats move up or down.

The display shows the content of data stored in the selected track. In the sequencer, performance information is converted and stored as MIDI data such as this.

Location of Events

The position of each item of MIDI data (event) is identified by measure number, beat number and clock pulse.

Indicates the clock pulse within the beat
Clock : = 96 (0 - 95)

Indicates the measure number.
Measure : = 1 - 16

Track	1	2	3	4	5	6	7	8	9	10
M	1	2	3	4	5	6	7	8	9	10
	20	53	53	10						
	1	1	1	1						
	E	C	C	C						
	5	4	5	5						
	76	60	72	72						
	58	56	71	64						
	40	45	35	49						
	==== Meas 2 (Beat 4/4) =====									
	(2) -	53	1	C	5	72	64	49		
	(1) -	10	1	C	5	72	64	49		

Indicates the beat within the measure

Event Indication

Each MIDI message written in a song is termed as an event. There are numerous types of events, as shown in the following :

Note	MIDI Ch	Note No.	Velocity	Gate
	MIDI Channel	Determine Pitches	Determine volume	Determine gate time
	1 - 16	(C-1) - G9 (0-127)	1 - 127	1 - 65535
PAf Polyphonic Aftertouch	MIDI Ch	Note No.	Value	
	MIDI Channel	Specify which note should take on aftertouch	Specify values	
	1 - 16	(C - 1) - G9, (0 - 127)	0 - 127	
C. Chg Control Change	MIDI Ch	No.	Value	
	MIDI Channel	Specify which Control Change should be transmitted	Specify values	
	1 - 16	0 - 127 (121 - 127 are Mode messages)	0 - 127	
P. Phg Program Change	MIDI Ch	Value		
	MIDI Channel	Specify values		
	1 - 16	1 - 128		
Channel Af (CAf) Channel Aftertouch	MIDI Ch	Value		
	MIDI channel	Specify values		
	1 - 16	0 - 127		
Bender (Bend) Pitch Bender	MIDI CH	Value		
	MIDI channel	Specify values		
	1 - 16	(- 8192) - 0 - 8191		
Exclusive (EX) System Exclusive	The sub-window can be opened to perform edits, but you are limited to a maximum of 500 bytes. (F0 means start and F7 means end.) Move the cursor to the Manufacturers-ID to open the sub-window.			
Tune Request (TU)	No parameters exist			
Tempo Change (Tempo)	Set as an absolute in the range of 5 to 500. Memorized as its ratio in respect to standard tempo. * This is indicated only in the tempo track.			

Score and data

The following are examples showing how scores would appear when converted as actual data for the W-30.

(a) (b) (c) (d) (e) (f) (g) (h)
 CLK 0 48 0 24 48 72
 Beat 1 2 3 4
 Measure 1 2

(a) (b) (c) (d)
 CLK 0 24 0 0
 Beat 1 2 3 4 5 6
 Measure 1 2



When converted as W-30 data



When converted as W-30 data

```

5. Micro Edit
Track 1-1-CLK-Ch-Note No.-Vel--Gate
M 1-1-0-1-4-67-100-100
(2)-1-1-0-1-4-67-100-100
(3)-1-1-0-1-4-67-100-100
(4)-1-1-0-1-4-67-100-100
2-1-1-1-4-67-100-100
4-1-1-1-4-67-100-100
7-1-1-1-4-67-100-100
END
  
```

```

5. Micro Edit
Track 1-1-CLK-Ch-Note No.-Vel--Gate
M 1-1-0-1-4-67-100-100
(2)-1-1-24-1-4-65-100-100
(3)-1-1-0-1-4-64-100-112
(4)-1-1-0-1-4-64-100-20
END
  
```

3. About Sound Data

Data related to the sound module of the W-30 is called Sound Data.

Samplers

Conventional synthesizers internally produce waveforms such as sine waves and sawtooth waves, and through a variety of modifications, create a wide range of sounds. But it often very difficult to realistically synthesize natural sounds.

Samplers are based on a completely different concept ; that of recording with precision the natural sounds needed , making modifications, and using them as sources for playback. Samplers are capable of not only making changes in the pitch of the samples, but make possible a range of other operations such as waveform modification, and altered methods of playback for the waveform, that are only available on samplers.

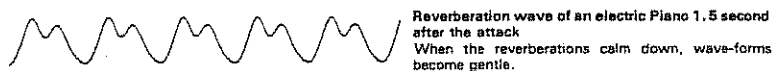
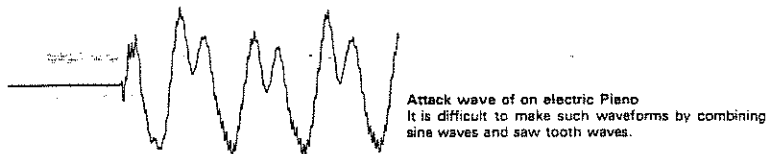

How then, does sampling differ from other types of recording ?

In not only the W-30, but in many other current instruments termed as samplers, PCM recording technology is employed. PCM recording techniques are also widely employed in rhythm machines, and digital effects devices, such as digital delays.

PCM is a method which examines incoming analog signals in extremely fine detail, and at minutely determined points in time, converts what it finds into numbers that it stores. To understand just how minute the divisions in time are, and when each piece of information is put in memory, we refer to the sampling frequency. With the W-30, you can choose between sampling frequencies of 30 kilohertz (kHz) and 15kHz. When sampling at 30kHz, data is being collected 30,000 times per second, and at 15kHz, 15,000 times per second.

As the illustration shows, the shorter the amount of time between each data sample (the higher the sampling frequency), the more faithful the quality of the sample will be to the original. However, the main drawback is that since the amount of data recorded then becomes that much larger, the allowable time length for recording is reduced, in comparison with a lower sampling frequency.

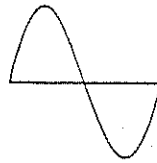

Input Wave form

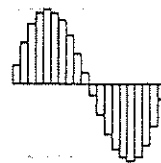

Converts the levels of a wave into digital signals.

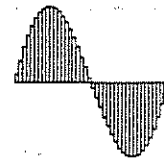

Roland's DI System

Roland Samplers adopt **the DI system**, which is a new technology developed specifically to resolve the problem of noise generation that can occur with so many other samplers when sampled data is interpreted (played back). Thus, a much higher quality of sound reproduction has been realized.

In what ways is the DI Method different?

A sampler, unlike a CD player, is required to reproduce samples over a range of varying pitches. Many samplers change pitch by changing the frequency of the playback. Roland, however, rather than altering the frequency that the data is interpreted at, employs a method which alters the spaces between the data. This is called the **fixed sampling method**.

Thanks to this method, any noise generated can be cut using a sharp digital filter, which is able to work on a specific, precisely defined frequency range. This results in the faithful playback of the original sound, without affecting its important harmonic contents.

This method, however, has posed difficulties in that there was a need for a reliable way of "filling in" the spaces between points sampled. Roland has succeeded in developing a way of carrying out such high-speed calculations, and provide intelligent interpolation for the imaginary points lying between sample points. The sampler looks well beyond the points in question for information, and makes its calculations using the leading-edge technique known as **differential interpolation**. As a result, noise is much less likely to even appear, assuring high quality sound.

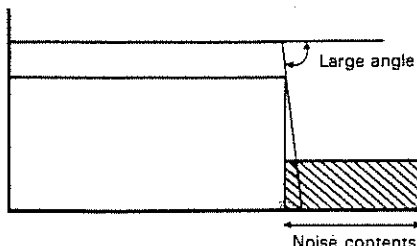

The Digital Filter sharply cuts the noise.

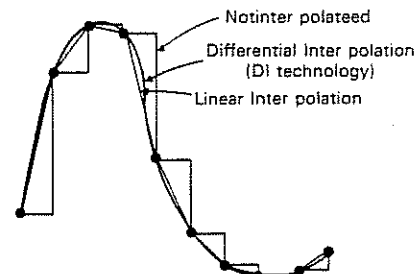

Contents of Sound Data

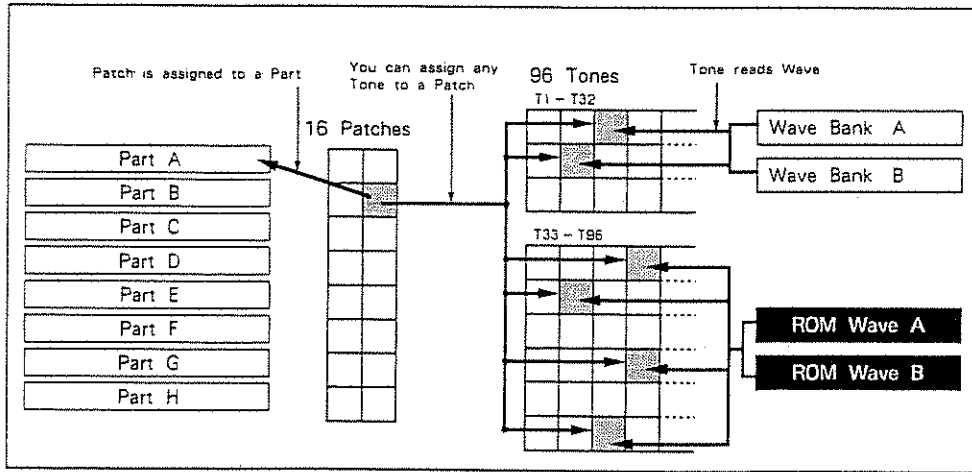

What is a Tone then?

A Tone represents the smallest unit of sound on the W-30, and consists of Wave data and the settings for the Tone Parameters. If you take Wave Data, and apply specific Tone Parameters to it, you then have a Tone.

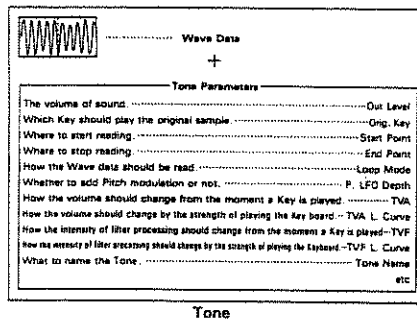

Tone Parameters

Wave data can be used as is, or combined with various Tone Parameter settings. Tone Parameters control how the recorded Wave data is interpreted and produced, and they are as important as the wave data itself.

By sounding a short sample (wave data) repeatedly, you can make it sound longer. Also, for example, you can have a sample of the word "Hello" be played as "Hello Hello Hello" or as "Hello lo lo lo", etc. Such effects are called "Looping", and can be obtained readily by using a sampler. (see page 63.)

Other Tone Parameters include LFO, for modulating pitch, volume or tone, and TVF and TVA for setting envelope curves for tone and volume. The Tone Name is also a Tone Parameter. (P.62,163,160)

**Difference between
Tones [1 - 32] and
Tones [33 - 96]**

There are two types of Wave data, that which can be rewritten and that which cannot be rewritten. Tone numbers [1] through [32] employ Wave data which can be rewritten, whereas numbers [33] through [96] rely on Wave data which cannot be rewritten.

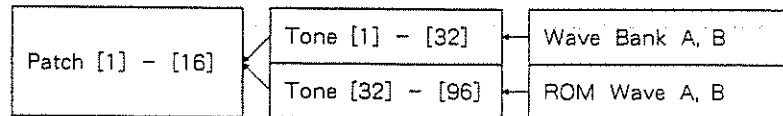

**●Rewritable
Wave Data**

The places where rewritable Wave data is stored are Wave Banks A and B. A Wave Bank can store either one long tone or many smaller tones.

Using both A and B Wave Banks, up to 14.4 seconds of sound (at a 30kHz sampling frequency) can be sampled.

The Wave data of a sample can be modified if you like. For example, unneeded portions of the Wave data can be truncated, or Wave data from two samples can be mixed. Two tones can be joined linearly to form one tone. The modified Wave data can also be stored in a Wave Bank.

**●Non-rewritable
Wave Data**

The two long Waves comprising ROM Waves A and B cannot be rewritten. These comprise a selection that, for most general purposes, are frequently used waveforms.

*** ROM Waves cannot be edited.**

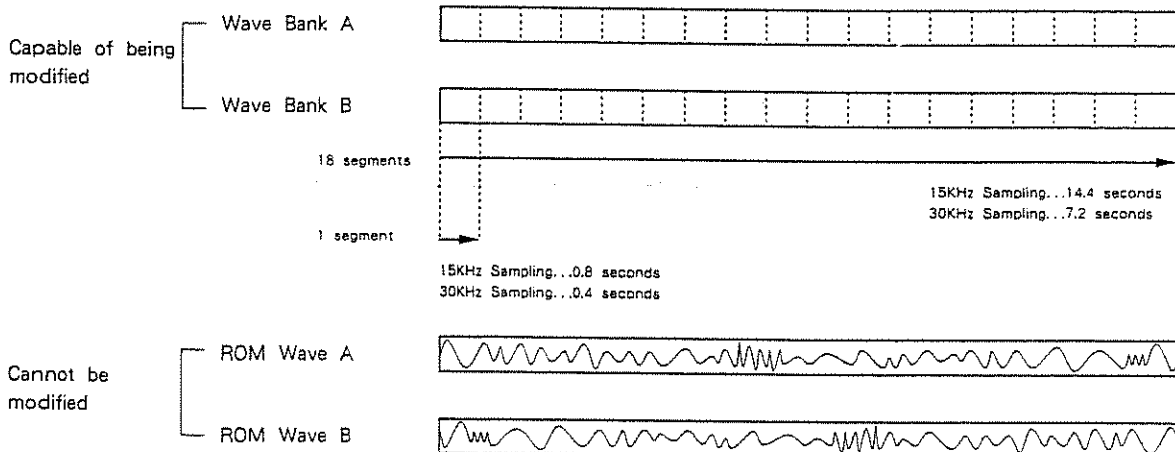

Original Tones and Sub-tones

Concerning Tones [1] to [32], the W-30 has two types of Tones : Original Tones and Sub-tones. Each sample has a Tone Number. For example, though, if each sample uses a whole Wave Bank, both A and B, only two tones can be programmed, leaving the other Tone numbers meaningless. To use the remaining Tone Numbers effectively, the W-30 allows you to borrow the Wave data of any of the existing Tones (Original Tones) to make a completely different Tone, with modified settings for the Tone Parameters. This then becomes what is called a Sub-tone.

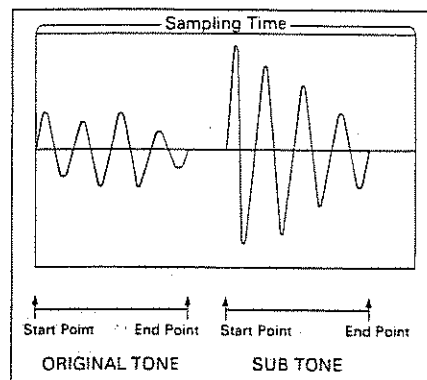

Through making differing settings for a Sub-tone's tone parameters, or adding vibrato to wave data, changing the envelope to delay the attack, and the like ; a variety of nuances can be created for tones. In addition, by truncating certain portions of Wave data, or combining it with others, and then also by altering the start and end points for playback, the same Wave data can be used to create several different sounding tones. This helps toward using the Wave Banks more efficiently. Such methods have been employed in creating the great variety of tones contained in the sample data in the supplied disks. (Making s Sub-tones, see page 61.)

Tones [33] to [96] are constructed in keeping with the concept of a Sub-tone.

Through specifying the Tone parameters, Start Point and End Point, the needed portion of a ROM Wave is read out.

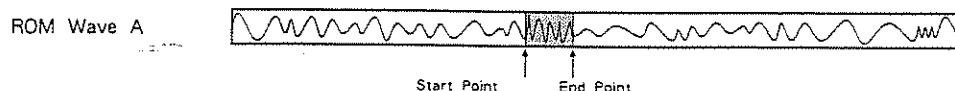

Patches

One or more Tones (Tone [1]-[96]), after being assigned to the keyboard, and supplied with Patch Parameters, form a Patch.

One sample can be played at varying pitches (keyboard ranges), but may sound unnatural or strange at much higher or lower pitches. With some sounds, even a pitch shift of about four notes is enough for you to notice a slight difference in naturalness. When pitched more than one octave higher or lower, the sound may seem quite different from the original sample. As a solution, when you wish to play an instrument sound over a wide keyboard range, for instance, if using a piano sound, divide the keyboard into 7 to 8 sections. Then sample representative notes, and distribute (split) the tones made from the wave data of the samples to each keyboard section. In this way, all the key ranges will sound natural. It is also interesting to distribute a different sound, such as special effects or drums, to certain keyboard ranges, so that you can have a variety of sounds depending on the keys you play. The W-30's keyboard has 61 keys (C2 to C7), but in fact, 109 keys (C0 to C9) are available for Tone assignment. Those keys which cannot ordinarily be played from the keyboard can be played via MIDI, or by shifting the playable range with the Keyboard playable range by an octave with the Keyboard Shift function (page 55,110).

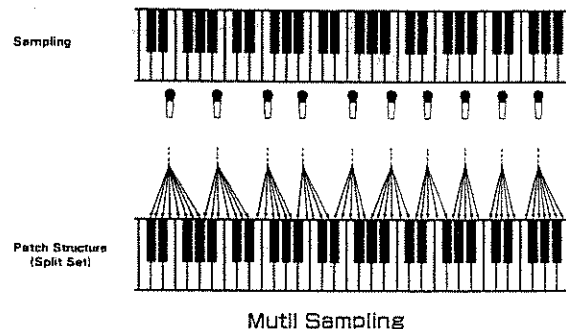

Changing sounds depending on how you play the keyboard

Actual piano sounds change depending not only on the pitch but also the strength of playing. When you play the keyboard softly, softer and rounder sounds are produced, and when played hard, heavier and more distinct sounds are created. This is to say that changing the volume alone is not sufficient for expressing different playing styles. To reproduce a realistic piano sound, separately sample the sounds which are created by playing the keyboard strongly and softly. Then have the stronger sound play only at times of stronger playing action, and the weaker sound play only when playing more softly.

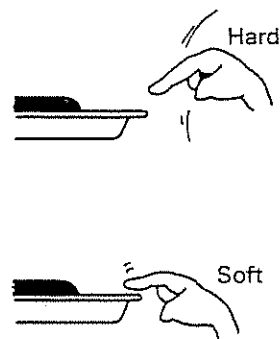

This can be done with "Fade" in the Key Mode (page 59, 148).

Patch Parameters

With such Patches (Tone Assignment to Key Ranges) you create, you can also make settings for various Patch Parameters, such as those for bender range or aftertouch. The patch name also is considered as one of the Patch Parameters.

8 Parts

The W-30 has 8 Parts, A to H. You assign Patches based on each Part. Each Part has a different MIDI channel and receives the MIDI messages sent from the keyboard, sequencer and MIDI IN on the relevant MIDI channel, playing the Patch assigned to that Part.

In other words, through sequencing, the W-30 can be used much like 8 separate sound modules.

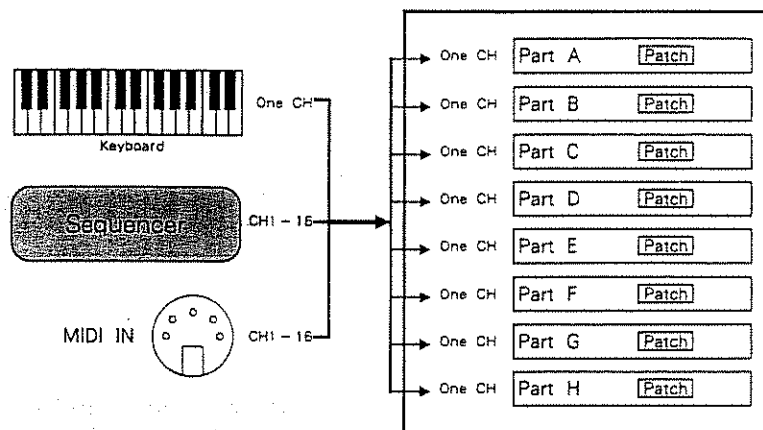

This function (playing more than one sound at the same time) is called Multi-Timbre.

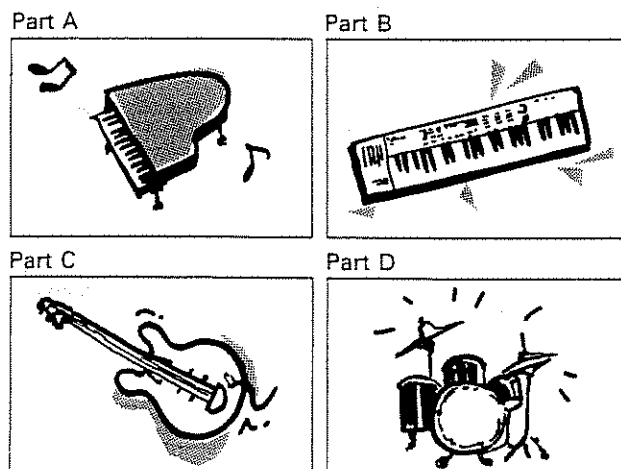

* Caution: The maximum number of voices simultaneously played is 16.

Understanding Parts

You should take a look at what Parts A to H contain.

① Press **SOUND** to select [31. Sound Menu].

② Press **F1** to select [32. Part Set].
The screen shows the data of Parts A to D.

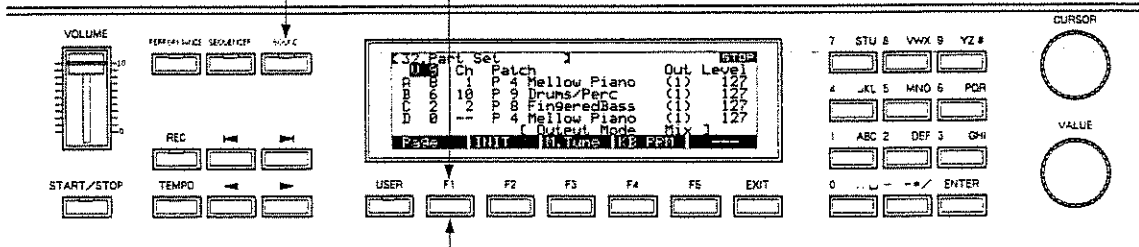

③ Press **F1** to change, and display Parts E to H.

32. Part Set					STOP
	Ch	Patch	Out	Level	
A	8	1 P 4	Mellow Piano	(1)	127
B	6	10 P 9	Drums/Perc	(1)	127
C	2	2 P 8	FingeredBass	(1)	127
D	0	-- P 4	Mellow Piano	(1)	127
[Output Mode Mix]					
Page	INIT	IN.Tune	KB PRM	---	

4. Interrelation of Functions

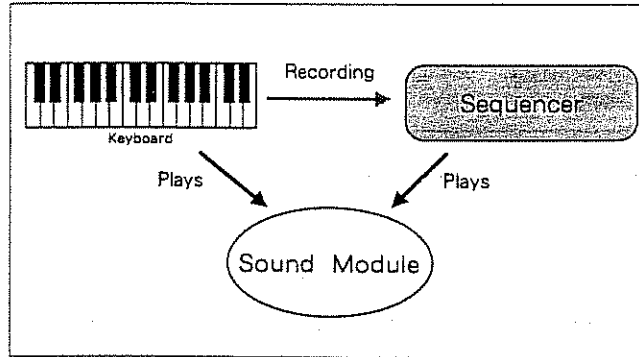

Employing
MIDI OUT and
MIDI IN

In addition to these three applications, the use of external devices via the MIDI IN and MIDI OUT sockets makes possible even more wide-ranging use of the W-30.

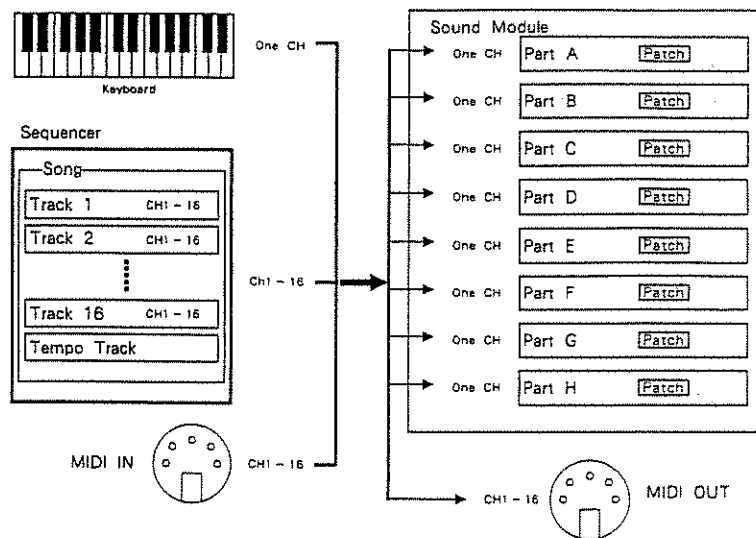
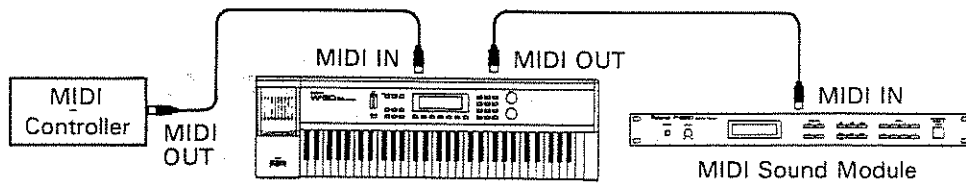

Since the paths for the above signals are provided with switches, certain signal paths can be blocked, if required.

Keyboard and
Sound Module

There are two ways that the W-30's sound module is played from the keyboard.

● The keyboard can directly play Patches on the sound module

With the modes shown below, the keyboard takes priority in controlling the sound source. Meanwhile, the sequencer can also be played. When the keyboard plays a patch it is termed Patch Play, and when it plays a tone it is referred to as Tone Play. (Keys located more than 2 octaves above the Orig. Key will not produce any sound.)

Screen	Sound produced by keyboard
[1. Performance]	Patch Play (Patch selected in the screen)
[35. Patch Edit Menu]	
[36. Patch Parameter]	
[37. Patch Split]	
[38. Patch Param Map]	
[39. Delete Patch]	
[40. Tone Edit Menu]	Tone Play (tone selected in the screen)
[41. Tone Parameter]	
[42. Loop]	
[43. LFO]	
[44. TVF Page 1,2]	
[46. TVA Page 1,2]	
[48. Tone Param Map]	
[55. Wave Edit Menu]	Tone Play (The tone selected in the screen)
[56. Copy * Move]	
[57. Truncate]	
[58. Mix]	
[59. Combine]	
[60. Digital Filter]	
[61. Wave Loop]	
[62. Sampling]	

*The settings in effect for Tone Play correspond to those for Out Level (volume), Bend Range, AT Assign, AT Sense (aftertouch), Oct Shift (octave shift), and Out Assign (output jacks) displayed in the [36. Patch Parameter] screen.

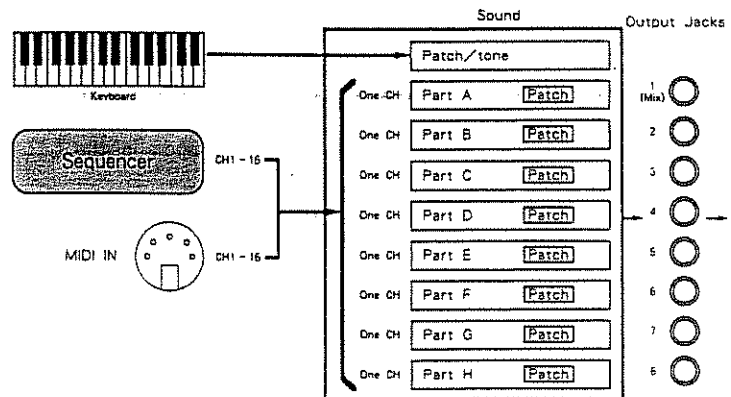

●The keyboard plays the Part on the same MIDI channel as the keyboard

In other screens, only the Part that matches the MIDI transmit channel set on the keyboard will be played. (see page 110,117,145.)

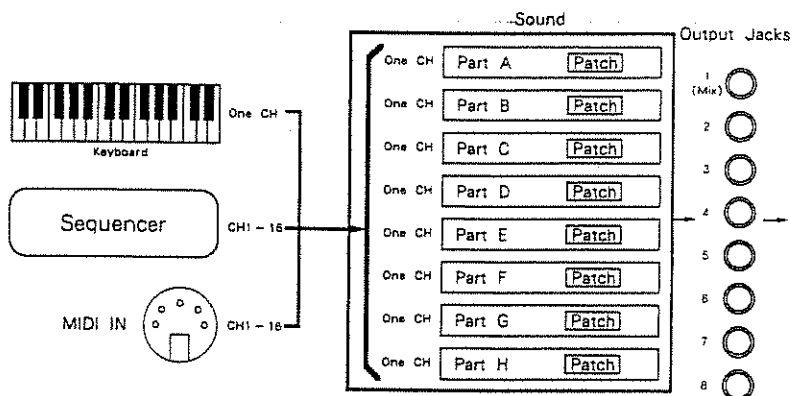

The [5. Micro Edit] screen is an exception, being as follows :

Screen	Sound produced by the keyboard
[5. Micro Edit]	<p>F3 Select is Ch = ALL :</p> <p>(Plays the Patch assigned to the Part on the same channel as the Keyboard Channel.) (see page 110)</p> <p>F3 Select is Ch = 1 - 16 :</p> <p>(Plays the Patch assigned to the Part on the same channel as the selected channel.)</p>

*On the W-30 the maximum number of simultaneously producible voices is 16.

Whenever this limit on producible voices is exceeded, as a result of messages received from the keyboard, sequencer, and MIDI IN, a system of priorities takes effect. This occurs in accord with the setting for Voice Mode made in the [32. Part Set] screen. (P. 54)

However, in all screens where the keyboard has priority, it maintains that priority in producing sounds.

* For a detailed illustration of the MIDI flow chart.

5. About the System

Data that determines how the W-30 will function is called SYSTEM DATA, and is stored on the System Disk.

Rewritable system data forms what is called a SYSTEM CONFIGURATION and can be written in the Performance screen (**F3** and **F4**). (see page 106, 110)

● SYSTEM CONFIGURATIONS

KB Ch	Keyboard Channel
KB Octave	Octave shifting over the keyboard
KB INT	MIDI switch : Keyboard → Internal sound module (local on/off)
KB EXT	MIDI switch : Keyboard → MIDI OUT
MIDI INT	MIDI switch : MIDI in → Internal sound module
MIDI EXT	MIDI switch : MIDI IN → MIDI OUT (MIDI Soft Thru)
TX Sync	Switch controlling transmission of clock, start, stop, continue, song position pointer, and song select data.
TX Sens	Active sensing data transmission switch
Modulation Depth	Value of modulation data transmitted when modulation lever is pushed.
Pedal SW [DP - 2]	DP - 2 assignment
EXP pedal [EV - 5]	EV - 5 assignment
Breath Controller	Breath controller data assignment

Assignment of screens to function keys.(see page 47.)

The patch number played by the keyboard when in the Performance screen.

The volume of sound played by the keyboard when in the Performance screen.

6. Memory

W-30 before being Booted Up

The W-30's memory stores Wave data which is retained even while the unit is switched off. However, no sounds can be played simply by switching the unit on.

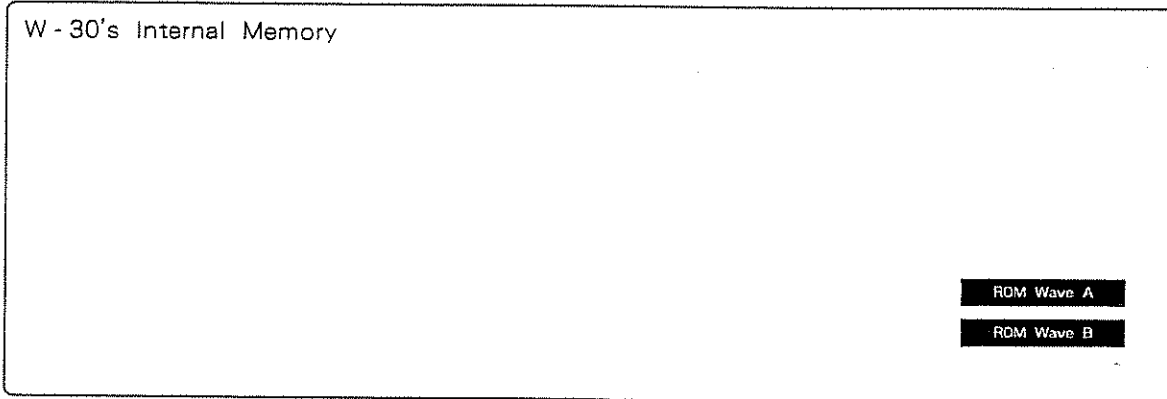

W-30 after being Booted Up

After booting up the W-30 with the system disk, you can play the Wave data stored in the internal memory.

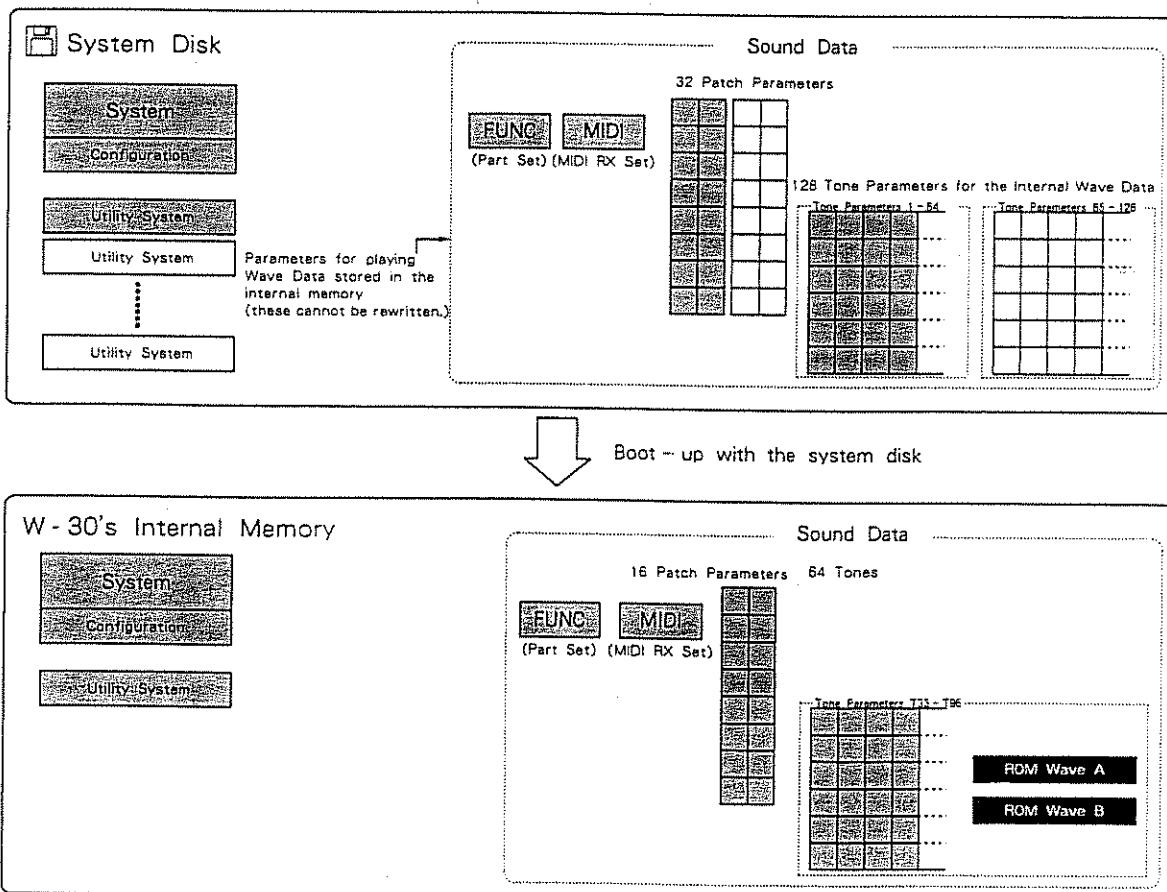

The W-30 loaded with Song and Sound data

When Song and Sound data is loaded to the W-30 from a data disk, the Sound data is prepared for use in playing songs.

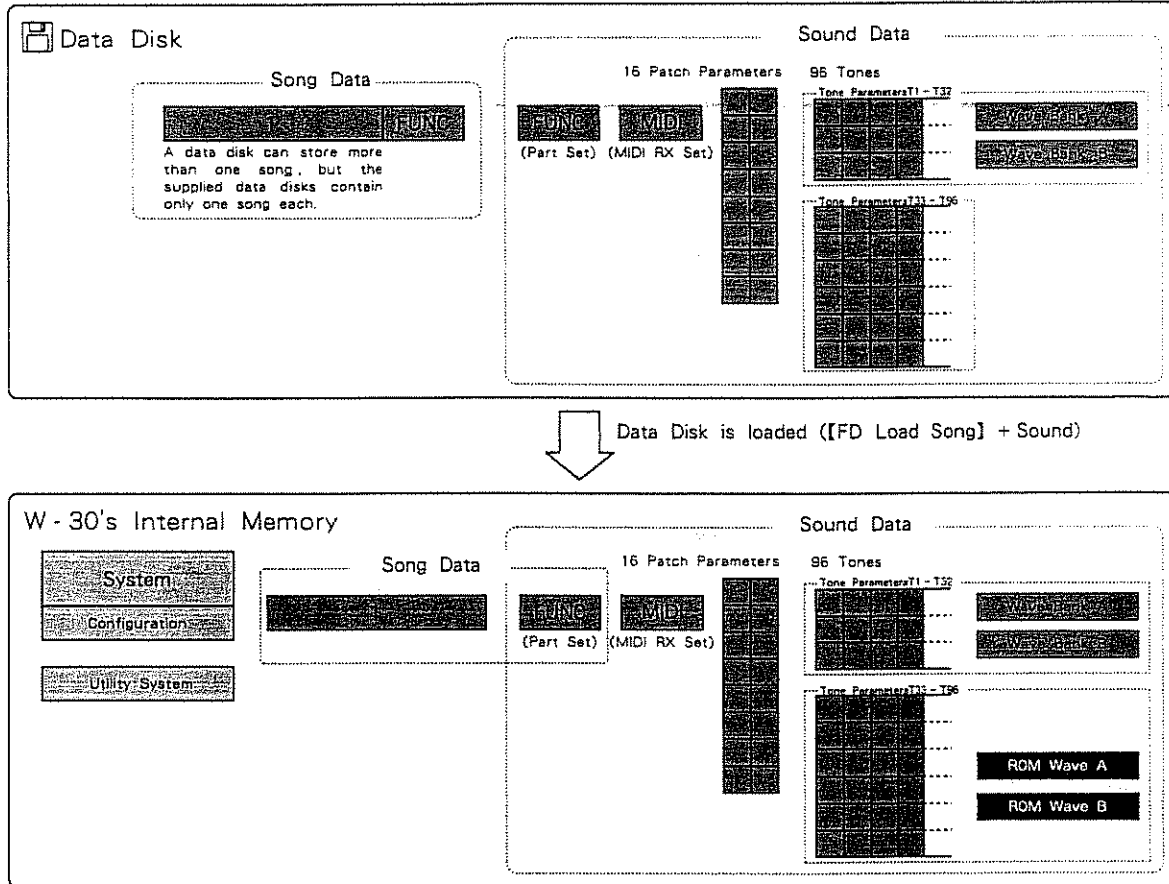

About FUNC Data

Settings determining which Patch for which Part, and which channel's data will be sounded (Settings in the [32. Part Set] screen, see page 144), are stored in both the song data and sound data on a disk. Internal FUNC settings are made as a result of loading from disk. These settings take on those of the Song data when, from the [50. FD Load Song] screen, you execute [F2] + Sound (song data and sound data are loaded together).

When multiple songs have been loaded into the W-30's internal memory, the settings for FUNC change when songs are changed.

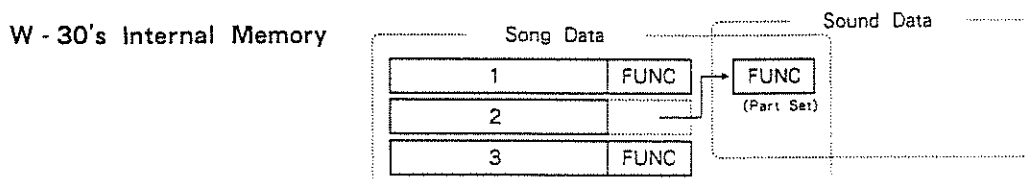

The 2 Types of Data Disks and Capacity

In addition to data disk such as those supplied, which store both sound and song data, you can also make song disks, for retaining large amounts of song data only. (See page 106.)

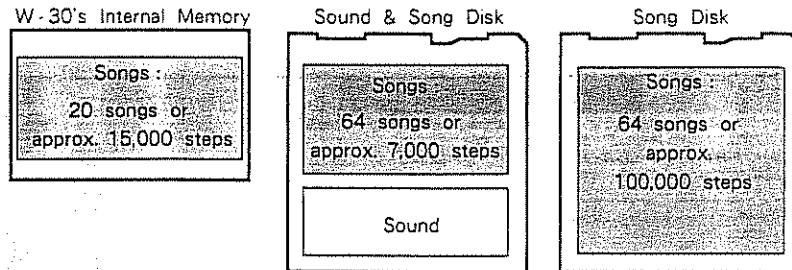

Using the Utility System

When the message "Insert System Disk and press F1 : **Load**" appears in the screen you have called, insert the system disk into the disk drive then press **F1**. In this way, the utility system programs can be loaded into the W-30 from the system disk, activating the W-30.

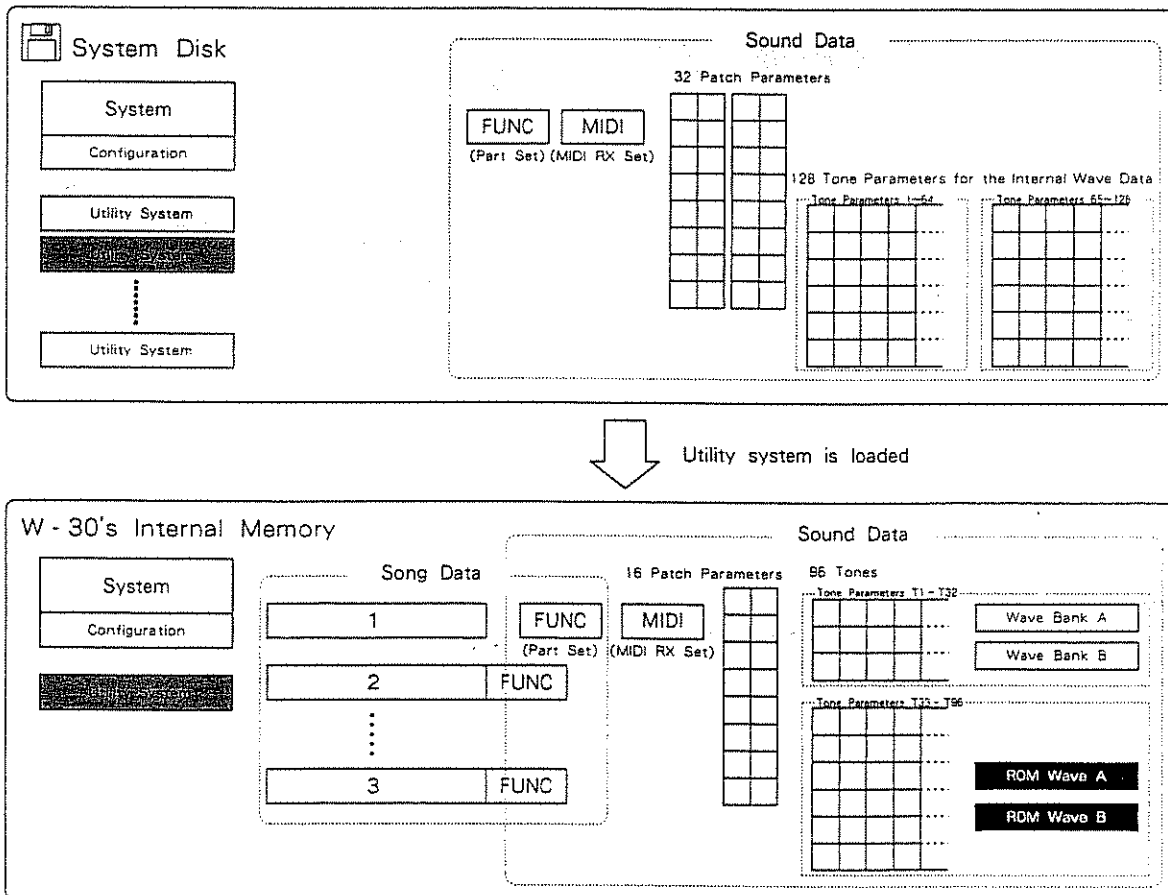

For explanation of data types, see pages 184.

Compatible Disks

Data from the following types of disks, originally for other models, can be used with the W-30.

● SONG DATA

MRC-500
 MRC-300
 SUPER-MRC
 Song Data for the S-50 (SYS-503)
 Song Data for the S-550 (SYS-553)
 Song Data for the S-330 (SYS-333)

● SOUND DATA

Sound Data for the S-50
 Sound Data for the S-330
 Sound Data for the S-550
 *Data for the S-330 and S-550
 can be loaded directly, using
 [50. FD Load Sound].

Also, song and sound data programmed in the W-30 can be converted so that it can be used for other models.

● SONG DATA

SUPER-MRC

● SOUND DATA

Sound Data for the S-50
 Sound Data for the S-330
 Sound Data for the S-550

*Data can be saved directly to
 S-330 and S-550 disks, using
 [51. FD Save Sound].

*Due to differences in specifications with certain models, in some cases you may not be able to make use of all types of data. (P.100,101).

*Disks created on the W-30 cannot be used with other models (S-50, S-550, S-330, MRC-500, MRC-300, and Super-MRC).

IMPORTANT ! Please Read This

Data (except for the internal Wave data) in the W-30's internal memory will be erased when the unit is switched off. To retain any data, save it onto a disk.

When using a brand new disk or one previously used for other models, be sure to format it (see page 106) before using it. Otherwise, data cannot be written to the disk. Use only double-sided, double-density, double-track 3.5" floppy disks - preferably Roland MF2-DD micro floppy disks. In order to prevent the accidental erasure of important data, disks are equipped with a "Protect" tab. When you wish to save data to a disk, first move the protect tab to the "Write" position

before inserting it into the drive. If left at the protect position, you won't be able to save anything onto the disk. When you have finished saving your data, make a habit of returning the tab to the "Protect" position.

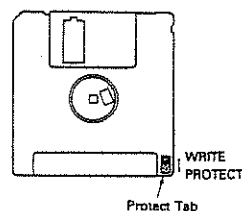

- To prevent accidental loss of data, be sure to set the Protect Tab to the PROTECT position except when writing (recording) data.



Chapter Three

Operating the W-30

Learning mode and screen organization.

1. The W-30's Operation Modes

The W-30 has a wide range of capabilities; for creating and editing songs, editing tones, or for changing the usage of tones. In order to allow convenient, quick access to the great range of functions, they are organized into a number of modes.

Mode	Function
<p>PERFORMANCE Mode</p>	<p>● PERFORMANCE [1. Performance]</p> <p>This mode is for playing the keyboard. It is of course also possible to play the keyboard while the sequencer is running. In addition, this mode allows you to make overall settings related to the W-30's system, such as Master Tune, Keyboard Channel, Pedal Assignment, etc.</p>
<p>SEQUENCER Mode</p>	<p>Mode employed for programming songs; including recording, editing, loading and saving songs.</p> <p>● SONG PARAMETER [3. Song Parameter] Allows you to set the song parameters, such as song name, metronome, etc.</p> <p>● RECORDER [4. Recorder] For recording song data.</p> <p>● MICRO EDIT [5. Micro Edit] Allows editing of song data a step at a time.</p> <p>● SONG EDIT [6. Song Edit Menu]... For editing a defined region of song data as a whole.</p> <p>● DISK [20. Sequencer Disk]... Used to transfer song data between a disk and the W-30's internal memory.</p> <p>● TRACK INFORMATION [30. Track Info] Provides for monitoring the data contents of the 16 Tracks.</p>
<p>SOUND Mode</p>	<p>This mode is for making settings related to the W-30's internal sound module.</p> <p>● PART SET [32. Part Set] This allows you to make settings for the 8 Parts.</p> <p>● RECEIVE SET [33. MIDI RX Set] Here you determine how each Part receives MIDI messages.</p> <p>● PATCH EDIT [35. Patch Edit Menu]... Allows you to edit Patches.</p> <p>● TONE EDIT [40. Tone Edit Menu]... Allows you to edit Tones.</p> <p>● DISK [49. Sound Disk Menu]... Provides for the transfer of data between a disk and the W-30's internal memory.</p> <p>● WAVE EDIT [55. Wave Edit Menu]... Here you can edit Wave data.</p> <p>● SAMPLING [62. Sampling] Carries out sampling of external sounds.</p>

2. Basic Procedures

It is very easy to operate the W-30, because the screens and button operations are organized to be familiar and consistent. The display shows what is currently available for you to perform. Simply learn the screen layout and general procedural steps.

Display Layout

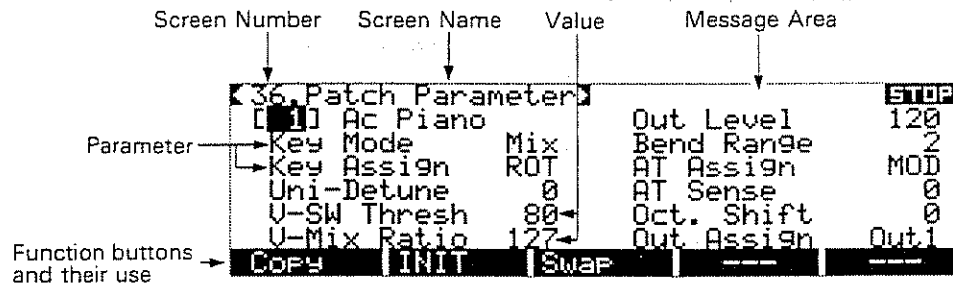

Whenever **STOP** is visible at the upper right of the display, you can play songs. (See page 18.)

Screen Selection

When you select one screen, you will be offered a selection among the next level of screens that are relevant to it. From any selected screen, you choose the next screen, and so on through the procedures you need.

* During recording, the screen cannot be changed.

Press a Mode Button first

All screens reside within either of the three modes ; Performance, Sequencer or Sound.

Press the mode button you need.

PERFORMANCE Press this for playing the keyboard or setting the system configuration.

SEQUENCER Press this for recording or editing songs.

SOUND Press this for editing sounds.

*The "Mode Chart" can be referred to for information on all the screens contained in these three modes.

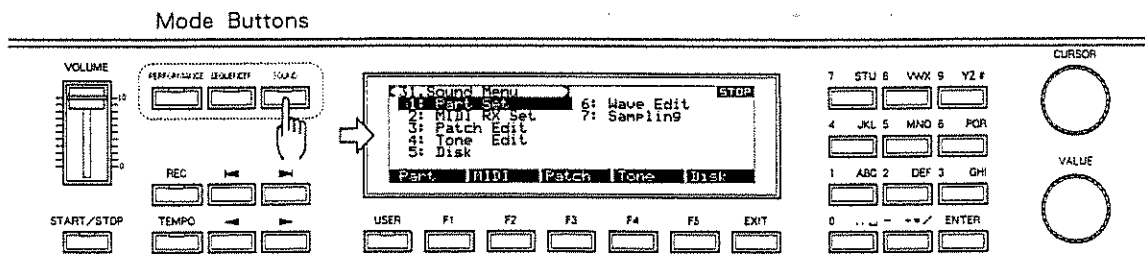

Next, select a screen from the menu

Press either **SEQUENCER** or **SOUND** and the Menu Screen will be displayed. Here select one of the screens available.

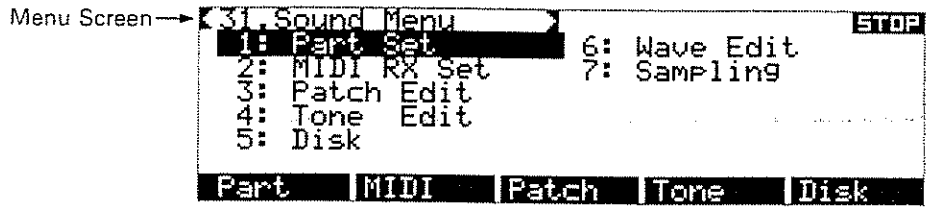

● Using the keypad, plus **ENTER**

Select from the menu with the numerical keypad, followed by **ENTER**.

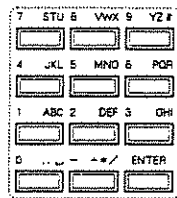

To go to screen 1, press **1**, then **ENTER**.

● Using the cursor, plus **ENTER**

Select the desired screen by rotating the Cursor Dial, then press **ENTER**.

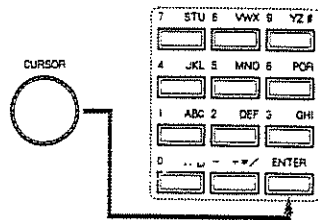

To go to screen 1, select 1 with the Cursor Dial, then press **ENTER**.

● Using the Function Keys

Screens 1 to 5 can be selected with the **F1** - **F5** keys.

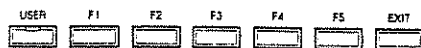

To go to screen 1, press **F1**.

* The bottom of the display shows how the keys function.

Selecting a screen directly with the numerical keypad

Regardless of the current mode, you can jump immediately to a desired screen by pressing its assigned number.

Screen Number
32.Part Set

① Press **USER**. ② Input the screen number with the keypad or VALUE knob. Rotate the VALUE Dial to change the listed screens.

③ Press **ENTER** to jump to the screen number you have specified.

Registering frequently used screens

You can also register frequently used screens as **F1** through **F5** so you can quickly access them later.

● **Registration** How to register the screen you want to a Function Key.

① Press **USER** twice. ③ Press the Function Key to which you want to register the screen. ② Use the value dial or numerical keypad → **ENTER** to select the number of the screen you wish to register. The listed screens will change.

● **Jumping to the registered screen**

① Press **USER**. ② Press the relevant Function Key.

Selecting a function with a Function Key

In addition to the parameters shown in the screen, certain other functions can be selected with the Function Keys.

The indication represents the function of the relevant button

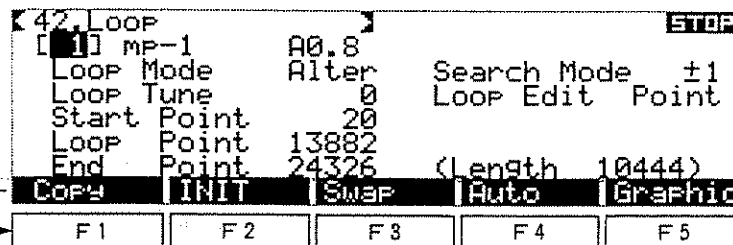

The following are the functions available with the Function Keys.

- Changing the menu listing **Page**, etc.
Changes the current list to a different one.
- Setting Parameters **REC PRM**, etc.
For setting parameters relevant to the current screen.
- Executing Commands **Copy**, etc.
Executes commands relevant to the current screen. Commands cover operations that the W-30 offers, such as data copy, data transfer, etc.

Sub-windows

Some screens selectable with function keys have sub-windows. Some Parameters in the sub-window can be set with the Function Keys.

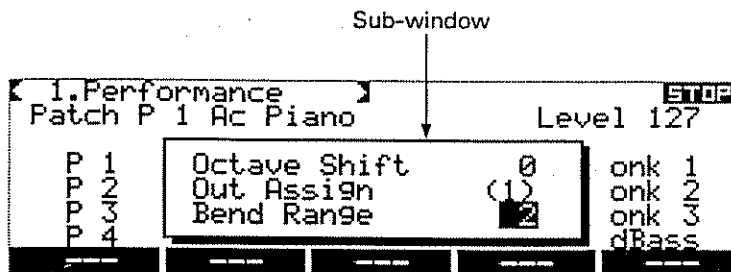

EXIT takes you back one step

Press **EXIT** to return to the previous screen. Otherwise, when a sub-window is open, pressing it cancels the function and closes the window.

Mode Button takes you to the top

Press a Mode Button to jump to the initial screen for the mode.

Press **PERFORMANCE** and you will be in the [1. Performance] screen.

Press **SEQUENCER** and you will be in the [2. Sequencer Menu] screen.

Press **SOUND** and you will be in the [31. Sound Menu] screen.

Cursor Movement and Value Changes

Move the cursor to the parameter to be changed, and change it.

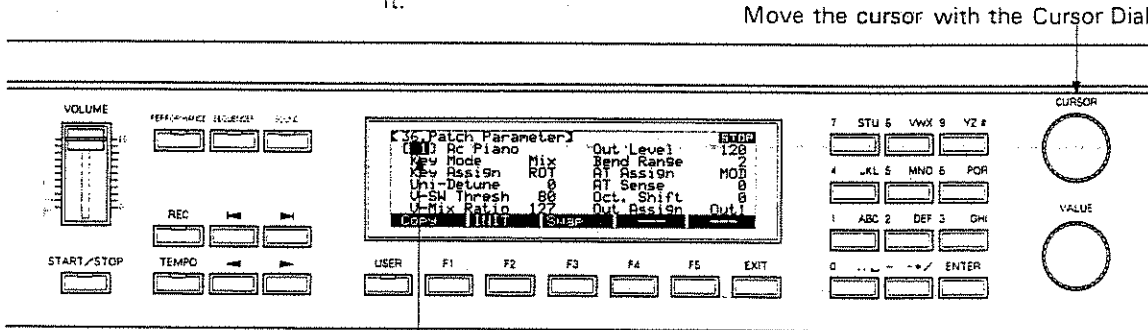

Cursor

Moving the Cursor

- Move the cursor with the Cursor Dial.

Changing Values

- VALUE Dial

Rotating the VALUE dial changes the value.

- Numerical Keypad

Press the number then **ENTER**. For instance, to enter 18, press **1**, **8** then **ENTER**.

<Exception> When you select a song number, rotating the VALUE dial will provide you with only the songs containing data. If you wish to select a song without data (record a new song), use the numerical keypad.

Entering Names

The characters needed in creating names for patches, tones, songs, tracks, disks, or sound memos can be selected using the keypad as well.

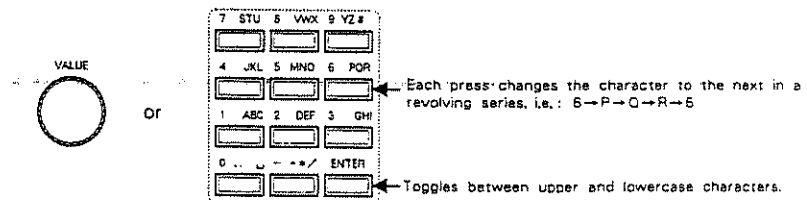

- Each press of a key moves you through a selection of the characters shown at the upper right of the key.
- Pressing **ENTER** will shift the character indicated by the cursor to either an upper or lowercase character.

Song Playing

Whenever **STOP** is visible at the upper right of the display, the W-30 is ready to play songs.

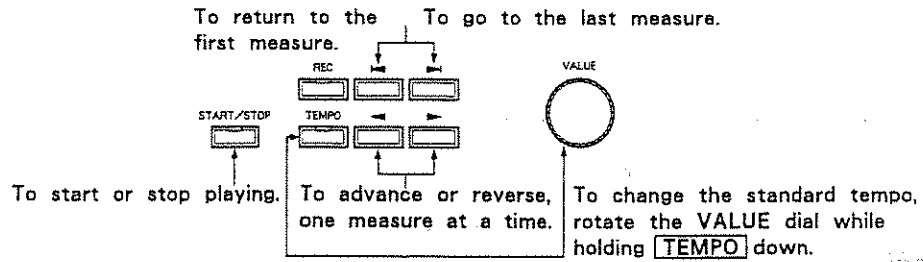

Chapter Four

A Functional Guide

This chapter illustrates the sequence of steps you should perform, arranged according to intended outcome.

1. To Change Volume 52
2. To Change Output Sockets 53
3. To Change the Number of Voices of Each Part 54
4. To Change Pitches 55
5. To Change Patches 56
6. To Create Sound Data 58
 - a. Making a Patch 58
 - b. Editing Tone Parameters 60
 - c. Editing Wave Data 70
 - d. Loading Sound Data from a disk ... 72
 - e. Sampling 77
7. Writing a Song 81
 - a. Recording 81
 - b. Re-recording portions of data 88
 - c. Micro Editing 92
 - d. Writing Tempo Change 94
 - e. Song Editing 95
 - f. Check of the Song Data 97
8. Saving Data onto a Disk 98
9. Pedal Control (Pedal Assignment) 99
10. Using data created on other models on the W-30 100
11. Converting W-30 data for other models 101
12. Using External MIDI Devices 102
 - a. To play an external sound module connected to the MIDI OUT socket 102
 - b. Using a MIDI Controller connected to MIDI IN 103
 - c. Sync to External MIDI Device 104
 - d. Recording while Synchronized to an External MIDI Sequencer 105
13. Other Functions 106
 - a. Saving System Configuration Data 106
 - b. Formatting a Floppy Disk 106
 - c. Copying a Floppy Disk 107

1. To Change Volume

To change the overall volume of the W-30.

Use the Volume Control Knob.

Because you directly control digital data when changing volume, you obtain a wider dynamic range, at more subtle increments, as you increase the volume. Thus, if you set the volume control knob as high as possible and adjust the volume on the mixer or amplifier, you may get the best results.

To change the volume played on the keyboard.

In the Performance mode and with Patch Edit, Tone Edit, Wave Edit, or Sampling.

In the Sequence mode with Part setting or MIDI RX setting.

PERFORMANCE

SOUND

F1 : Part

[1. Performance]
Adjust the Level.

[32. Part Set]
Adjust the Level of the Part currently played on the keyboard.

To change the volume of each Part.

To change the volume for each Patch.

To change the volume for each tone.

SOUND

F1 : Part

SOUND

F3 : Patch

F1 : Param

SOUND

F4 : Tone

F1 : Param

[32. Part Set]
Adjust the Level of each Part.

[36. Patch Parameter]
① Select the Patch to be edited.
② Adjust the Out (output) Level.

[41. Tone Parameter]
① Select the tone to be edited.
② Adjust the Out Level.

EXIT

F5 : TVA

To change the volume depending on the strength of keyboard touch.

[46. TVA Page 1]
① Select the tone to be edited.
② Adjust the TVA.
Select the L. Curve (see page 163.)

F5 : Page

[47. TVA Page 2]
Set the TVA envelope.

2. To Change Output Sockets

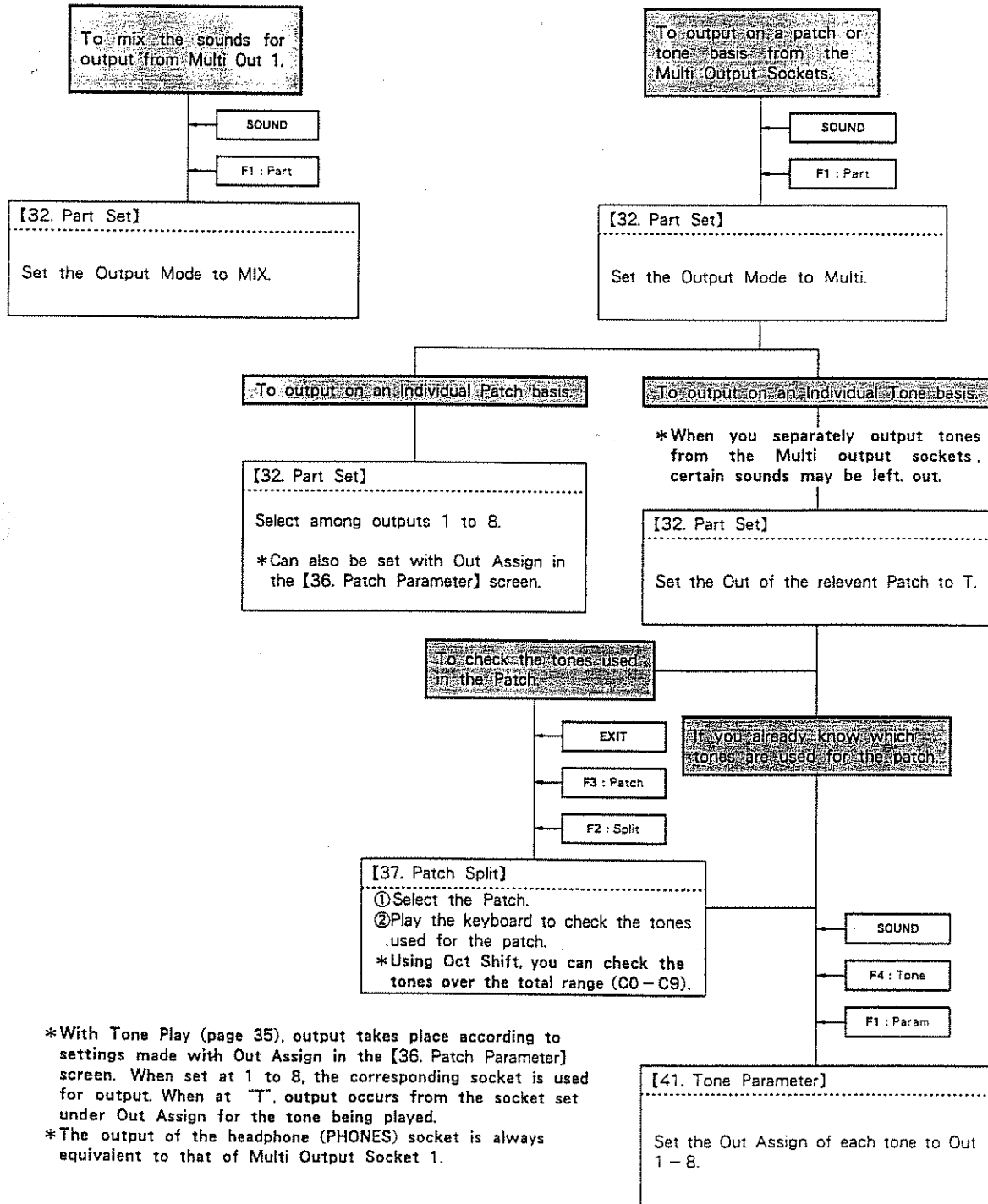
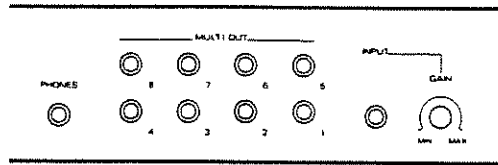

3. To Change the Number of Voices of Each Part

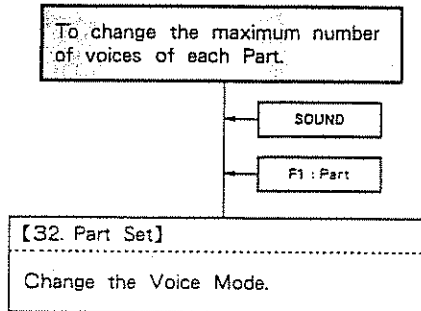

[32. Part Set]							STOP
Ch	Patch	Out	Level				
A 8	1 P 4 Mellow Piano	(1)	127				
B 6	10 P 9 Drums/Perc	(1)	127				
C 2	2 P 8 Fingered Bass	(1)	127				
D 0	-- P 4 Mellow Piano	(1)	127				
[Output Mode Mix]							
Page	INIT	M. Tune	KB PRM	---			

Voice Mode

The number of voices that can be simultaneously played on the W-30 is 16. (This may be reduced depending on the conditions.) You can select one of the following three modes that determine how these 16 voices should work.

● Voice Fix Mode [V1] – [V22]

This mode assigns the 16 voices to the Parts. There are 22 different ways for voice assignment. When the W-30 has received more Note On messages than the producible number of voices, the later messages are ignored, and priority is given to sounds already playing.

Voice Mode	1	2	3	4	5	6	7	8	9	10	11
A	16	14	12	12	10	10	10	8	8	8	8
B	0	2	4	2	6	4	2	8	6	4	4
C	0	0	0	2	0	2	2	0	2	4	2
D	0	0	0	0	0	0	2	0	0	0	2
E	0	0	0	0	0	0	0	0	0	0	0
F	0	0	0	0	0	0	0	0	0	0	0
G	0	0	0	0	0	0	0	0	0	0	0
H	0	0	0	0	0	0	0	0	0	0	0

Voice Mode	12	13	14	15	16	17	18	19	20	21	22
A	8	6	6	6	6	6	4	4	4	4	2
B	2	6	6	4	4	2	4	4	4	2	2
C	2	4	2	4	2	2	4	4	2	2	2
D	2	0	2	2	2	2	4	2	2	2	2
E	2	0	0	0	2	2	0	2	2	2	2
F	0	0	0	0	0	2	0	0	2	2	2
G	0	0	0	0	0	0	0	0	0	2	2
H	0	0	0	0	0	0	0	0	0	0	2

● Voice Auto Mode

The 16 voices are used in sequence regardless of the Parts. When the Note On messages of the corresponding channel are received, the Patch assigned to the Part is played.

[VAL] (Last Note Priority/Auto Mode)

In this mode, when the W-30 has received more Note On messages than the maximum producible voices (16); of sounds already playing, those of the least volume are cancelled, allowing newly received notes to have priority in sounding.

[VAF] (First Note Priority/Auto Mode)

In this mode, when the W-30 has received more Note On messages than the maximum producible voices (16), the later messages are ignored, retaining the currently playing sounds.

*It is possible to set multiple receive channels, of parts A to H, to the same number, but this will cause a slight sound delay; particularly when the Voice mode is set to VAL (Last Note Priority in the Auto Mode).

4. To Change Pitches

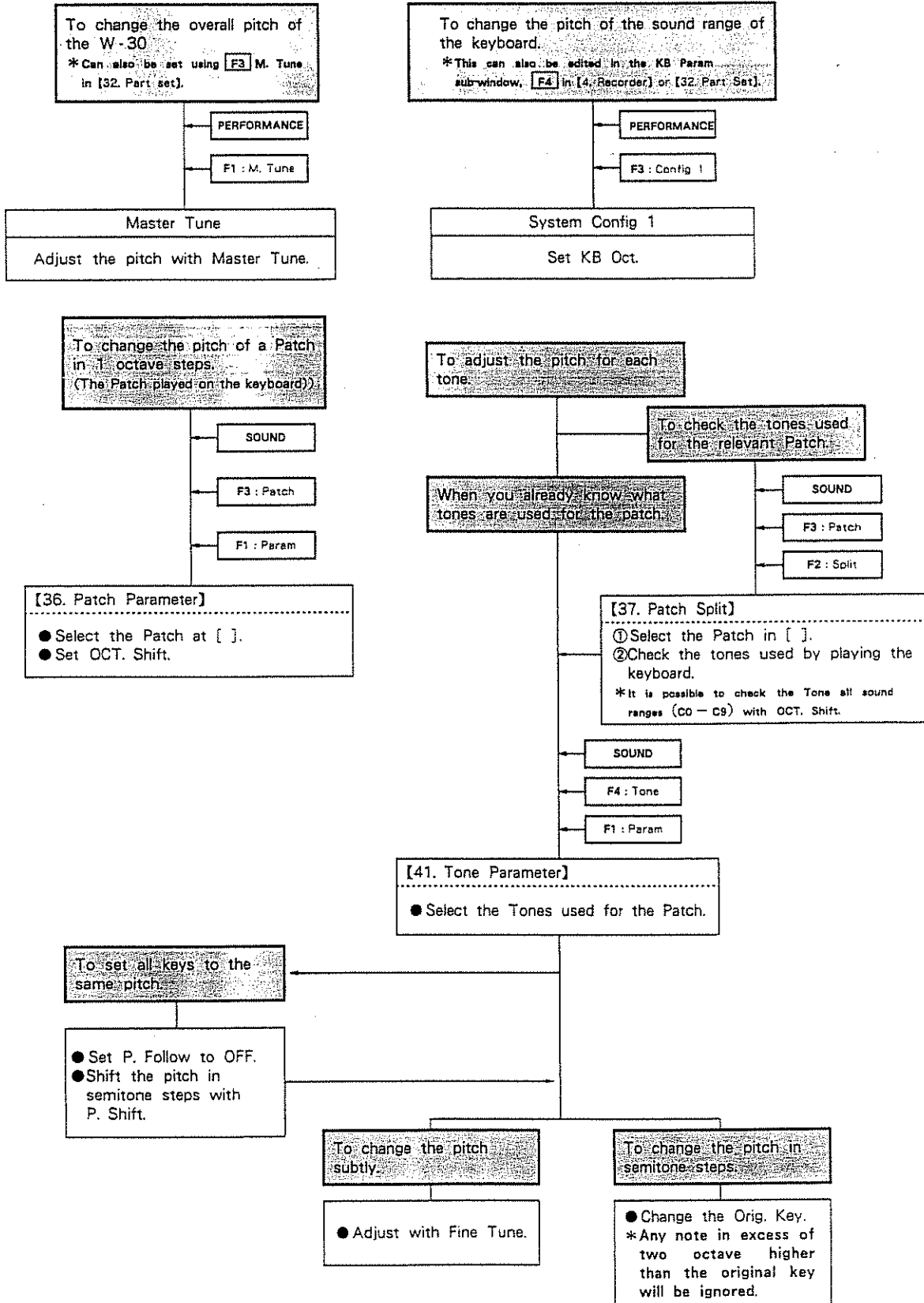

5. To Change Patches

In the Sequencer, Part Setting or MIDI RX Setting screens

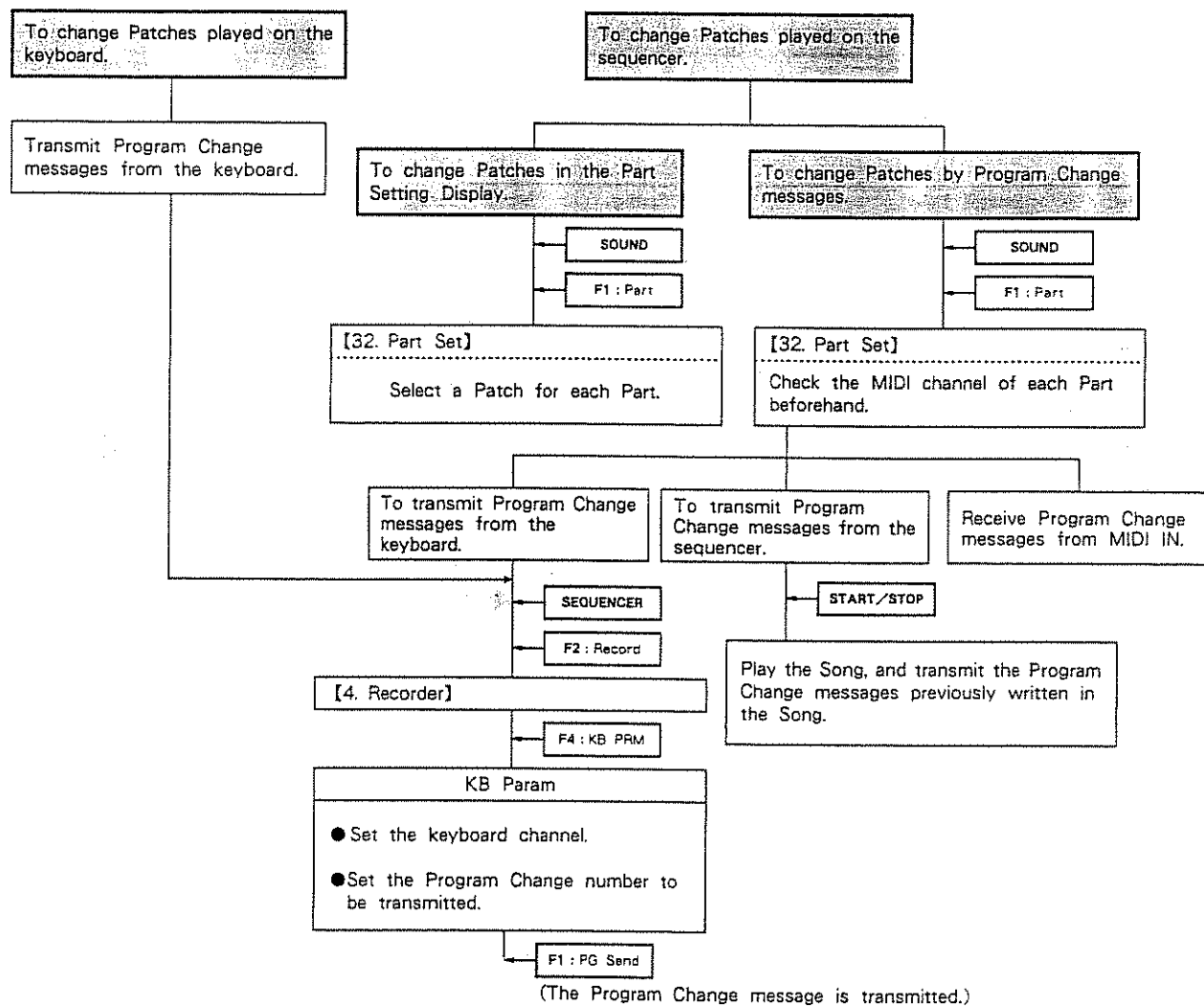

In the [1. Performance] screen

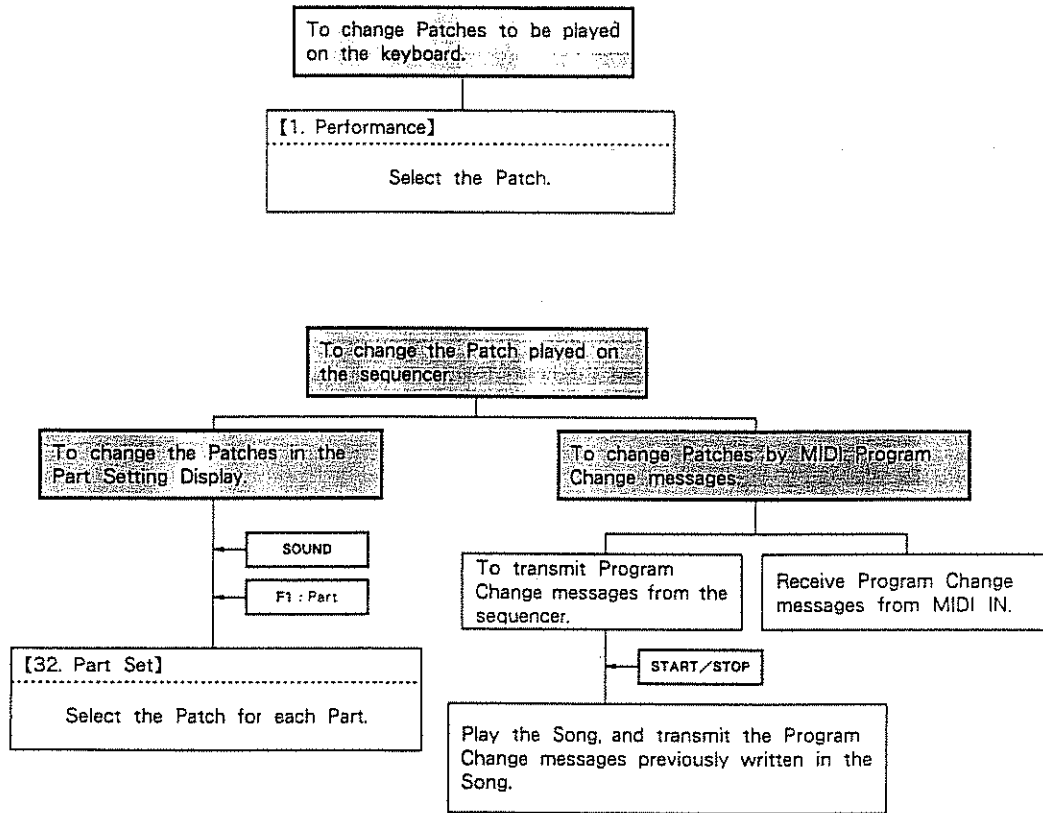

Setting Program Changes

You can determine at will the Program Change numbers and Patch numbers you need to use.

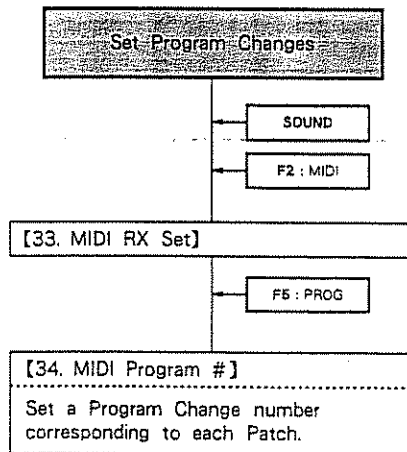

*If the same Program Change number is assigned to more than one Patch, the Patch having the smallest number has priority.

6. To Create Sound Data

a. Making a Patch

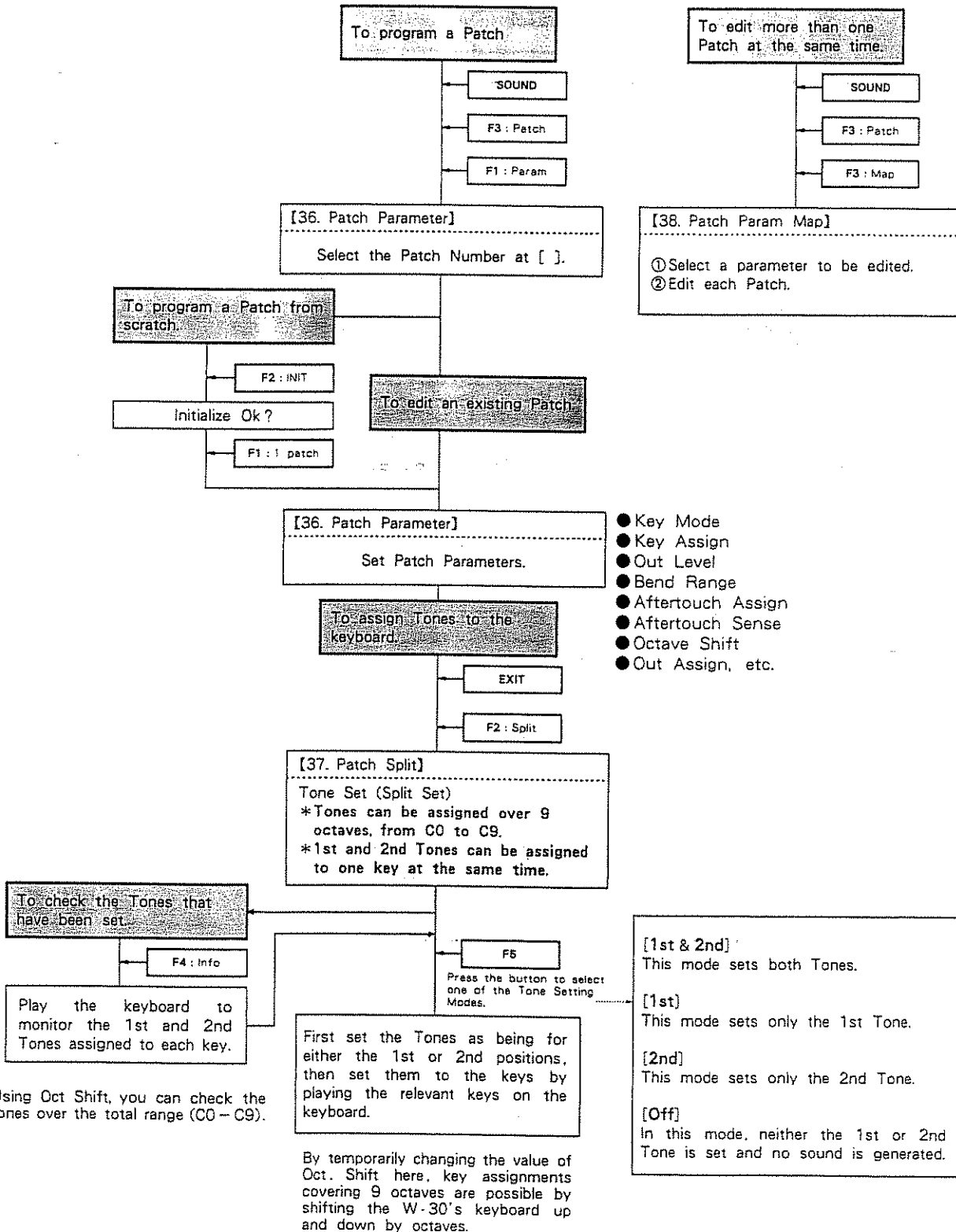

Confirming Tone Set

37. Patch Split STOP
 [1] Ac Piano Set Mode *Info*
 Key Mode Mix 1st: 1 MP-1
 Oct Shift 0 2nd: 1 MP-1

Split Point
 Upper : 2nd tone
 Lower : 1st tone
 (When tones assigned to keys that are adjacent are different.)

2 MP-2 ← 1st tone
 3 MP-3 ← 2nd tone

Copy INIT Swap Info Set

Key Mode

The actual sound obtained by playing the keyboard is determined by the tone settings, and key mode.

[Norm] (Normal)

The 1st Tone assigned to the key is played. One voice module is obtained by playing one key.

[Uni] (Unison)

The 1st Tone assigned to the key is played. Two voice modules are obtained by playing one key, therefore the maximum number of voices playable is reduced to 8. It is possible to adjust the pitch of one of the modules subtly with Uni-Detune.

◇When the Key Mode is set to [Norm] or [Uni]
 Only the 1st Tone is played. The 2nd Tone is irrelevant.

[Mix] (Velocity Mix)

1st and 2nd Tones are mixed. Two voice modules are obtained by playing one key, therefore the maximum number of voices playable is reduced to 8.

[V-SW] (Velocity Switch)

The 1st Tone is obtained by playing the keyboard softer, and the 2nd Tone is obtained by playing the keyboard harder. The threshold level is set with V-SW Thresh (Velocity Switch Threshold).

[Fade] (Velocity Crossfade)

The volume balance of the 1st and 2nd Tones is changed by playing the keyboard harder or softer. (The level curve of the 1st Tone is reversed.) Two voice modules are obtained by playing one key, therefore the maximum number of voices playable is reduced to 8.

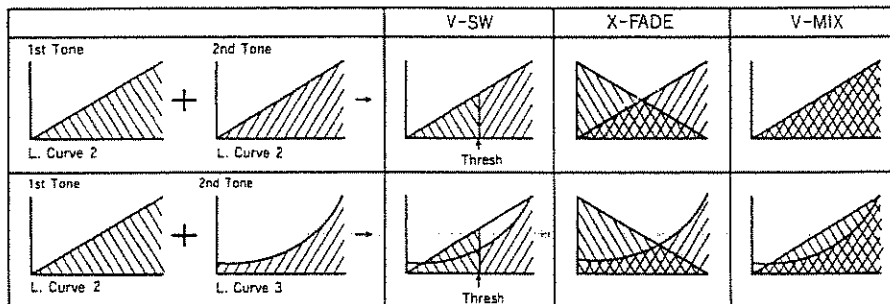

*In any Key Mode, the volume of each Tone is determined by its Level Curve (see page 163) and the respective strength of keyboard playing.

b. Editing Tone Parameters

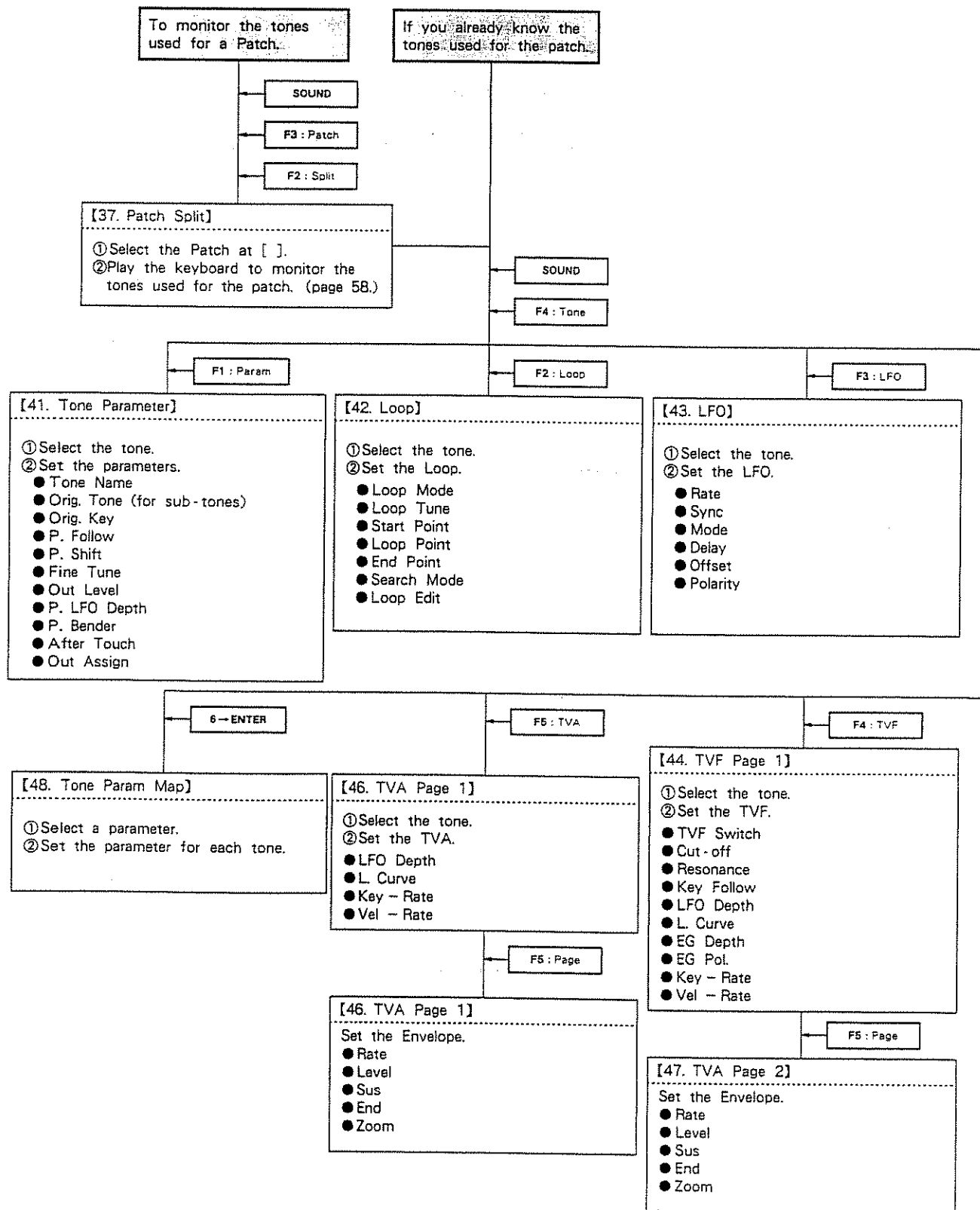

Tone List

Let's have a look at the Tone List in the [41. Tone Parameter] screen.

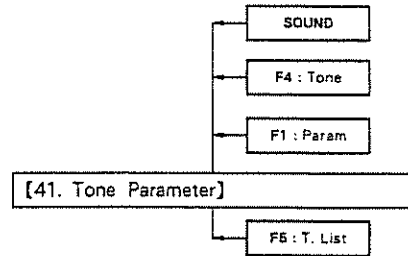

you can distinguish among Original Tones, Sub-tones, and ROM Tones since their tone name indication is different.

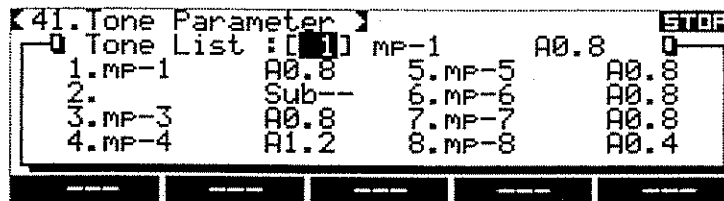

- e.g.)
- A0.8 30kHz sampling of Wave Bank A, 0.8 second tone.
 - B2.0x2 15kHz sampling of Wave Bank B, 4.0 second tone.
 - Sub10 Sub-tone that borrows the wave data of original tone [10].
 - ROM A Tone using ROM Wave A
 - ROM B Tone using ROM Wave B

Making a Sub-tone

A Sub-tone is made of the wave data borrowed from an Original Tone.

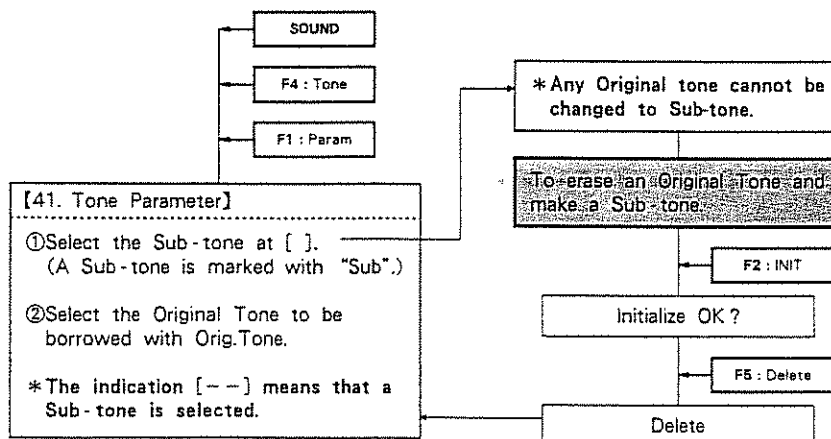

Using LFO

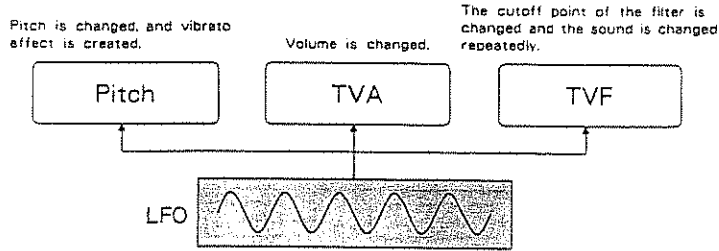

By employing LFO, periodic changes are made in pitch, volume, and the filter's cutoff point.

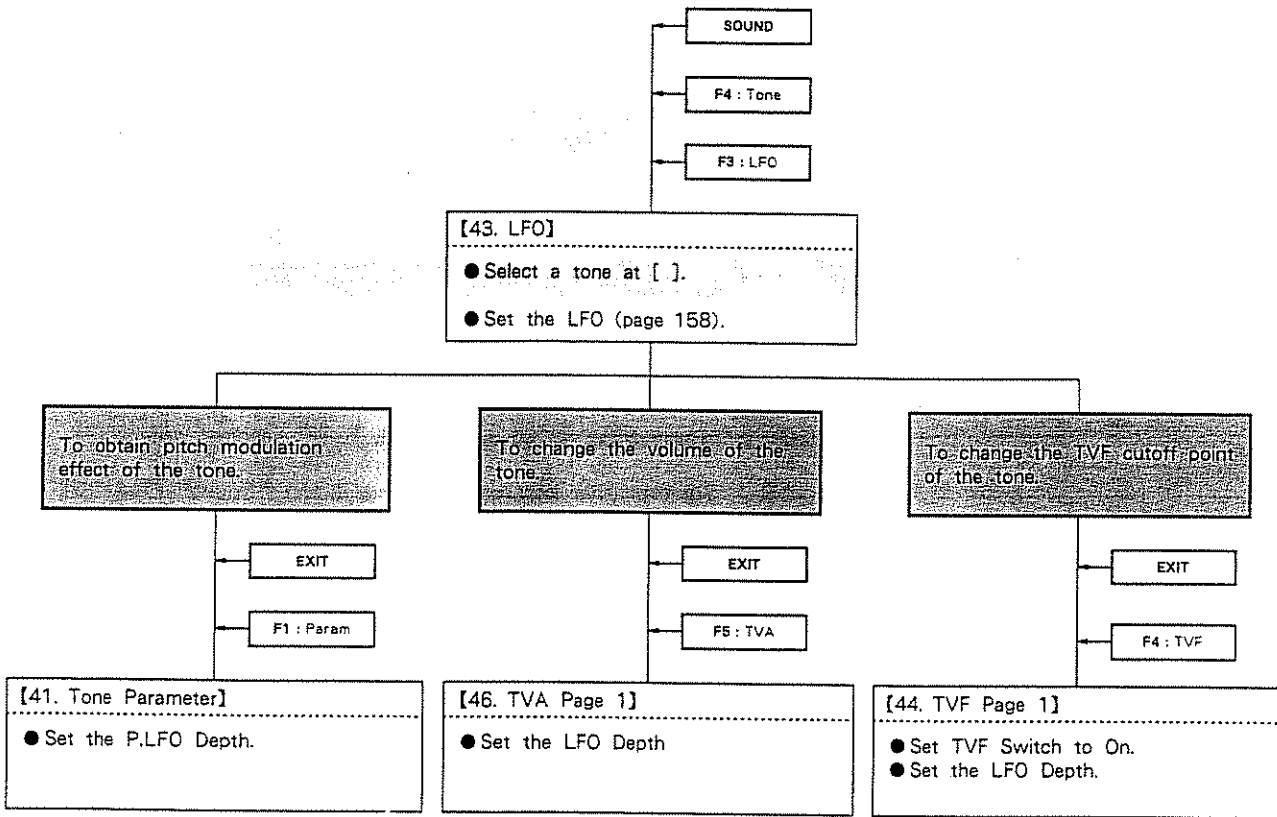

Creating Loops

You can have wave data or a part of the wave data be repeatedly played (looped) as long as you press a key. One shot (playing a sample only once) is usually better for percussion sounds. For sustained sounds such as flute or violin, you can loop the stable part of the wave data. Also, by looping entire waveforms, or by playing them in reverse, special effects can be obtained.

Start Point
Loop Point
End Point

The Start Point is where the W-30 starts playing the wave data and the End Point is where playback ends. You can select any portion of the sampled wave data to be played, as delimited between Start and End Points.

For looping, a Loop Point, which determines where the loop will begin, is inserted. A loop then repeats the data lying between Loop and End points (see page 29,30).

Each point is identified by an address (page 71) . The beginning of the wave data is address 0.

Loop Mode

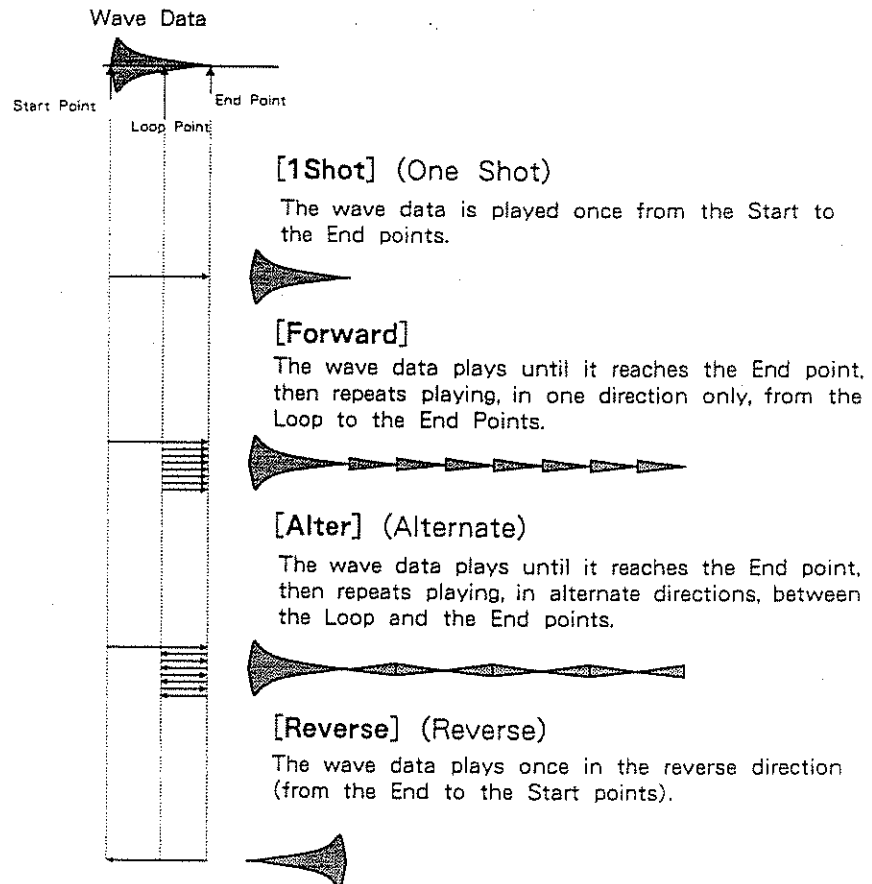

Procedure for Making a Loop

By Looping, the wave data from the Loop to the End points is played repeatedly. To obtain a successful sustained sound, these two points should be combined smoothly. That is, it is necessary to find the best Loop and End points. The following are procedure for successful looping.

The W-30 provides the following 3 methods for use in making loops :

① Search for the best points as you actually listen to the sound.

To search for points easier, the Peak Search function (Search Mode) is provided.

② Let the W-30's internal computer find out the Loop and the End points. (Auto Loop)

When you cannot combine the Loop and End points successfully, you can have the internal computer do the job. However, the Auto Loop function may not be able to find appropriate points when the waveform is too complicated.

*The Auto Loop function may not be able to find a loop when the range you set for the search is too limited. Set the loop fairly long, and try with a variety of settings.

*Auto Loop searches only for a [forward] loop, therefore, executing Auto Loop automatically turns the Loop Mode to [Forward].

③ Modifying the Wave Data for better Looping (Smoothing)

Wave data sampled from natural sounds often have very complicated waveforms, hence it may be difficult to find appropriate Loop and End points. At times, it is impossible to obtain a natural sustained sound. To resolve this, the internal computer modifies the waveform between the Loop to End points so that the forward loop will be made natural. This is called the "Smoothing" function.

*Smoothing is performed by computer calculation, so the sound of the waveform cannot be monitored during modification.

*33 - 96 are ROM waves, so the Smoothing function cannot be used on them.

*Since the wave data of the selected tone itself is directly revised, copy the tone first (page 170) if you wish to retain the original waveform.

Procedure for Looping

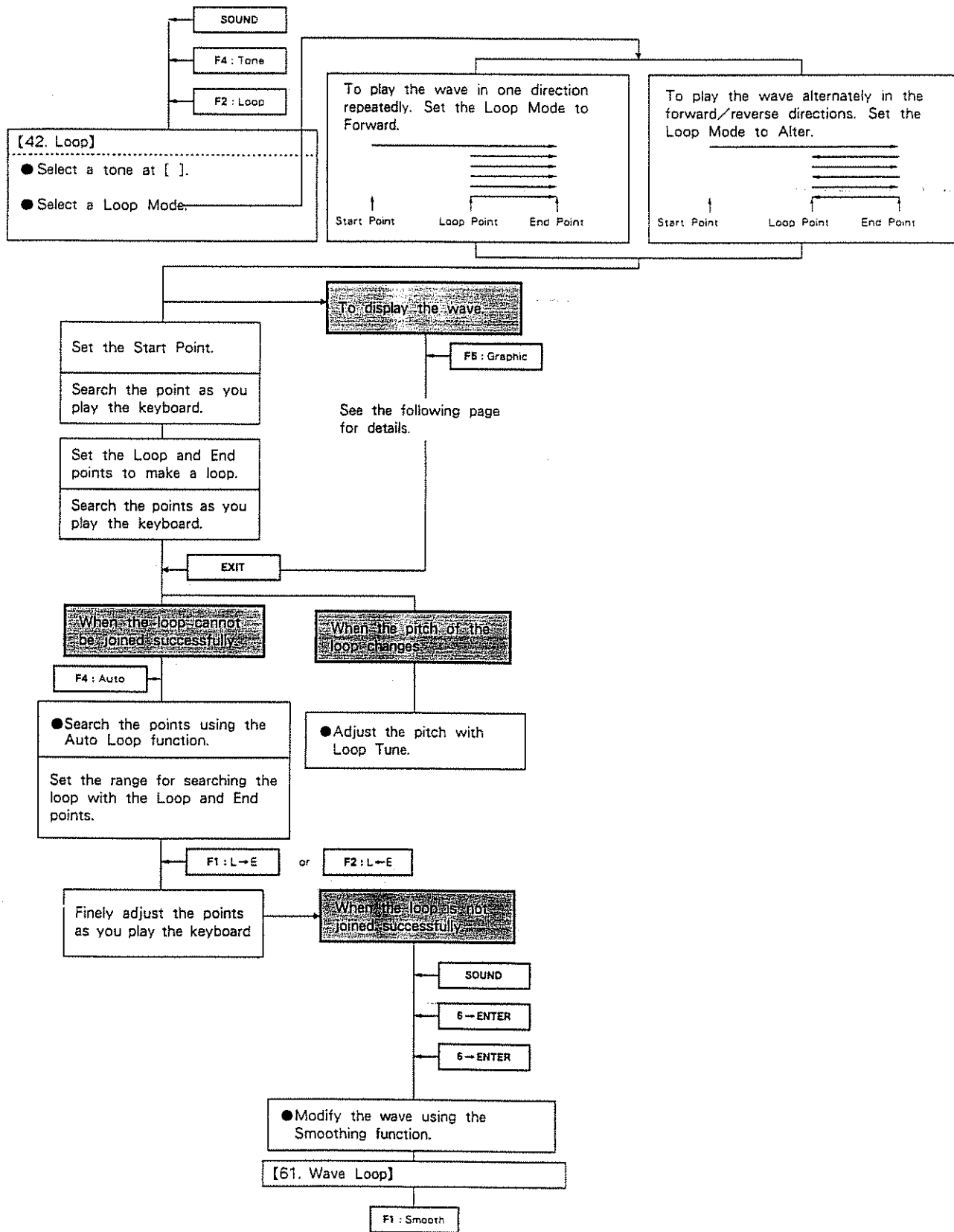

Wave Display

Three screens are provided for helping you set each point.
As you play the keyboard, set the points using these three screens.

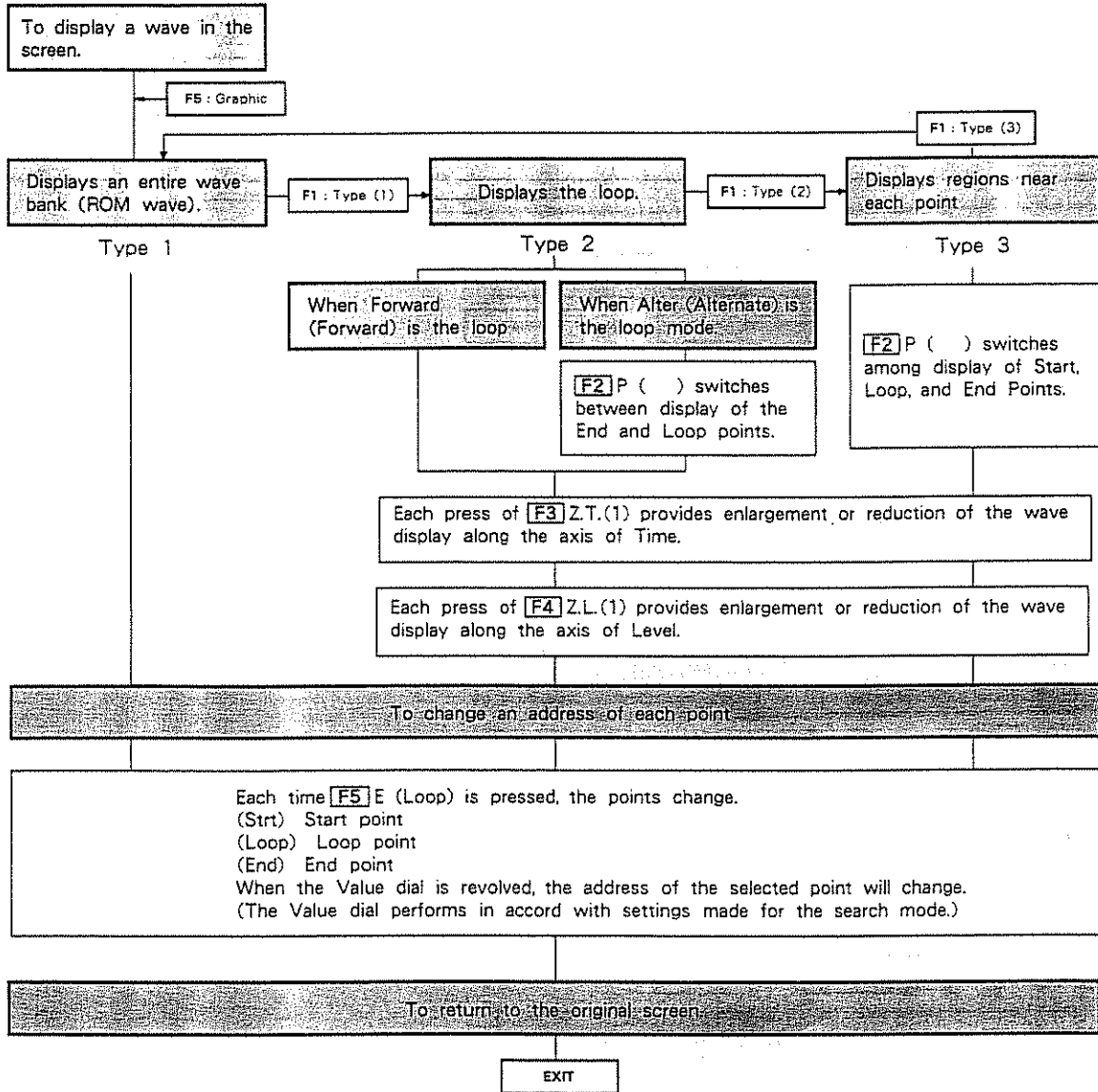

[Type 1]

The entire shape of the waveforms can be seen in this screen. Whether the wave is long or short, the entire wave is shown over the whole screen. The Start, Loop and End points are shown as small dots on the belt line above the wave display.

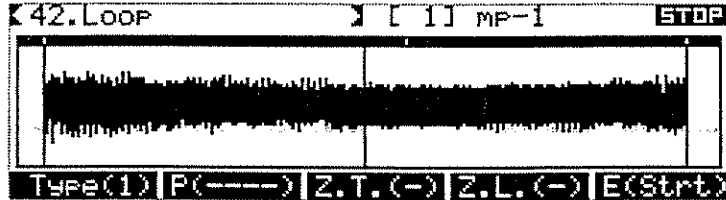

[Type 2]

In this screen, you can make a loop. You can make a subtle sustained sound more successfully if using the continuation of similar waves.

When the Loop Mode is at **Forward** (Forward), the left side of the center line shows the waveforms up to the End point, and the right side shows the waveforms from the Loop point. By connecting waves deftly on this line, a natural sustained sound can be obtained.

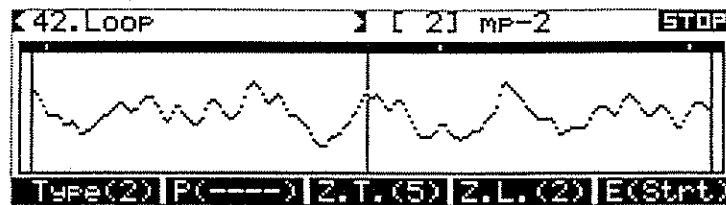

When the Loop Mode is set to **Alter** (Alternate), and you choose **F2** P (Loop), the center line becomes the Loop point. Therefore you can see the waveforms turned back at the Loop point. When you choose **F2** P (End), the waveforms are turned back at the End point. By connecting waves without spoiling the flow of the wave, natural sustained sounds can be obtained.

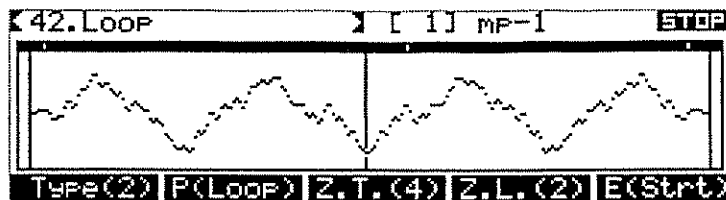

[Type 3]

In this screen, each point can be seen in detail.

Press **F2** to set to "P (strt)", and the center line becomes the Start point.

Press **F2** to set to "P (Loop)", and the center line becomes the Loop point.

Press **F2** to set to "P (END)", and the center line becomes the End point.



Times when new Wave data is created

In each of the following cases, Wave data is written anew to the Wave Bank.

- Wave data is edited
 - Copy * Move (tone parameters are copied.)
 - Mix (tone parameters are initialized.)
 - Combine (tone parameters are initialized.)
 - Digital Filter (tone parameters are copied.)
- Tone is loaded (tone parameters are copied.)
- Sampling performed (tone parameters are initialized.)

Selection of Tone Number for a new tone

The tone number of tones being newly created is selected at [] when sampling or loading tones; and at "Destination" when editing wave data.

● If you select an Original Tone

- The previous wave data included in that Original Tone is deleted and the space created is added to the existing "Remaining Time".
- New wave data is stored in the empty space in the selected Wave Bank.
- The Sub-tone that has borrowed the wave data is initialized and becomes an unused tone.

● If you select a Sub-tone

- Wave data is stored, and it becomes a new Original Tone.

*Tones numbered 33 through 96 cannot be selected as the destination of a write, since they are internal wave based tones.

Distinguishing Tone Types

You can distinguish between Original Tones and Sub-tones by means of the identifiers displayed to the right of the tone name.

- [1]-[32] : Original Tone sampled at 30kHz A $\frac{0.8}{\uparrow}$
(Wave Bank) (seconds/increments of 0.4)
- [1]-[32] : Original Tone sampled at 15kHz A $\frac{0.8 \times 2}{\uparrow}$
(when sampled at 15kHz)
- [1]-[32] : Sub-tones Sub $\frac{10}{\uparrow}$
(Original Tone from which the Sub-tone borrows wave data)
- [1]-[32] : Unused Tone Sub--
- [33]-[96] : Tones using ROM waves ROM - $\frac{A}{\uparrow}$
(ROM Wave)
- [33]-[96] : Unused Tone (ROM)

Checking the amount of space left (Remaining Time)

The amount of space currently remaining in each Wave Bank is displayed in terms of time (seconds) at the 30kHz sampling rate.

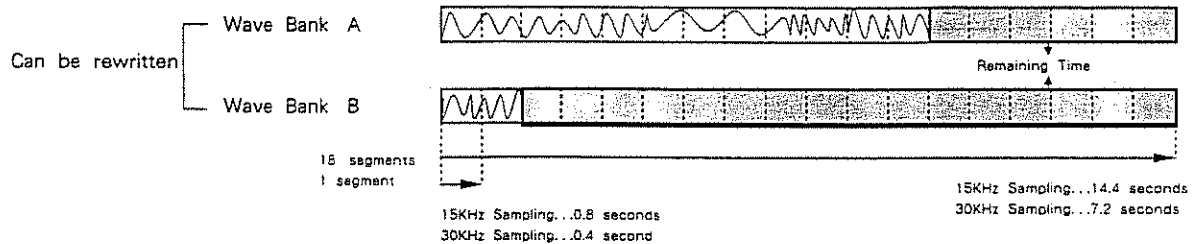

When new waves can no longer be written

In cases such as the following, "Can't Execute" will be displayed due to insufficient space in the wave bank.

- When the tone selected is a Sub-tone, and the remaining time in the wave bank it is to be written to is 0.0s.
- When the tone selected is an Original Tone, and the wave bank of the source Original Tone and that of the bank it is to be written to differ, and the remaining time of the destination wave bank is 0.0s.

* Even though there is insufficient space, the process can be executed, but take care since portions of wave data will be lost.

Delete

In situations such as above, the "Delete" function, provided in each screen, should be used to delete (1 tone) unneeded Original Tones. When an Original Tone is deleted :

- Wave data is deleted from the wave bank. In addition, the tone parameters are initialized, and an as yet unused Sub-tone having no Original Tone is created there.
- Sub-tones borrowing such data are at the same time deleted.

Deletion can also be performed on an entire Wave Bank (Bank - A, Bank - B) basis.

- All sampling data within the Wave Bank is deleted, and all relevant tone parameters are initialized. Unused Sub-tones having no Original Tone are created there.
- Sub-tones that relied on all such deleted data are at the same time initialized and become unused Sub-tones.

* Tones [33] - [96] are internal wave based tones, and therefore deleting tones [33] - [96] never increase Remaining Time of Wave Bank A or B

c. Editing Wave Data

Wave data of an Original Tone can be edited. The whole editing process is performed digitally, therefore, the sound quality is not deteriorated.

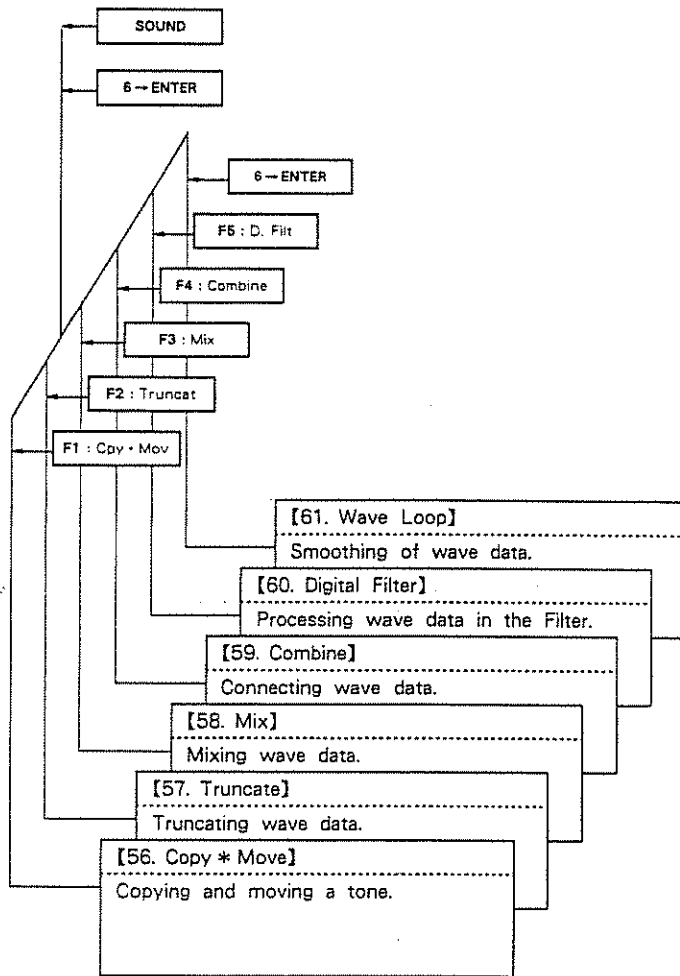

Wave data to be edited is stored in Wave Bank A or B.

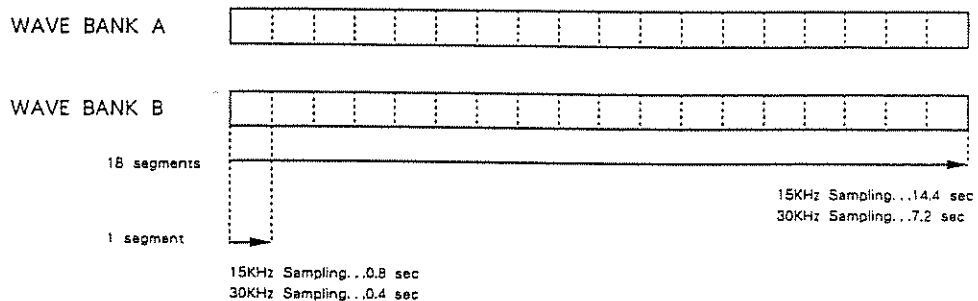

Tones [33] - [96] employ ROM waves which cannot be rewritten, therefore no editing can be performed on them.

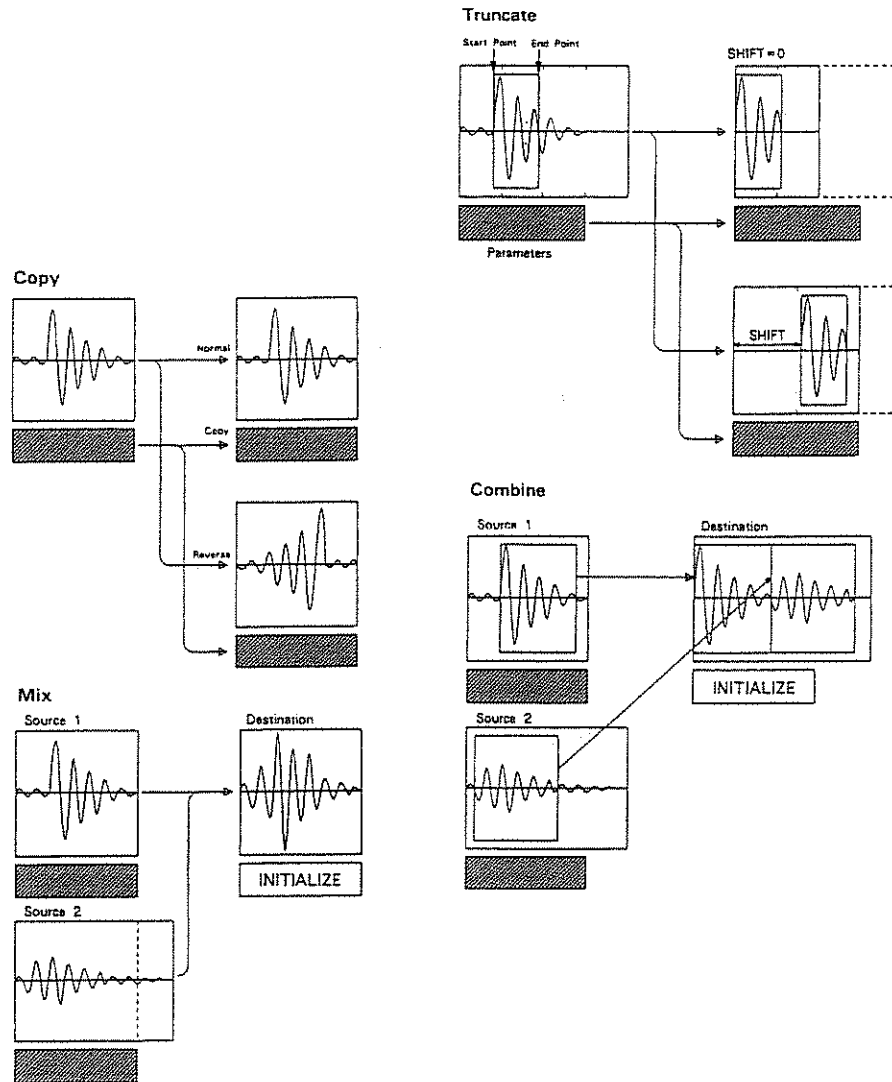

About the Address

The Start, Loop and End points of wave data are indicated by their positions in memory. This is called "Address."

The beginning of the wave data is address 0. The last point of wave data that uses an entire Wave Bank (7.2 seconds at 30kHz sampling) is [221183].

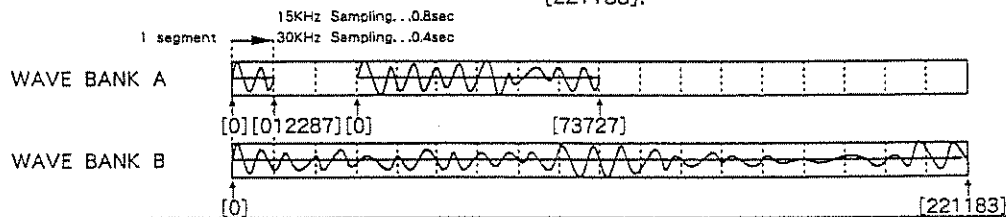

d. Loading Sound Data from a disk

Loading Sound Data from a Data Disk

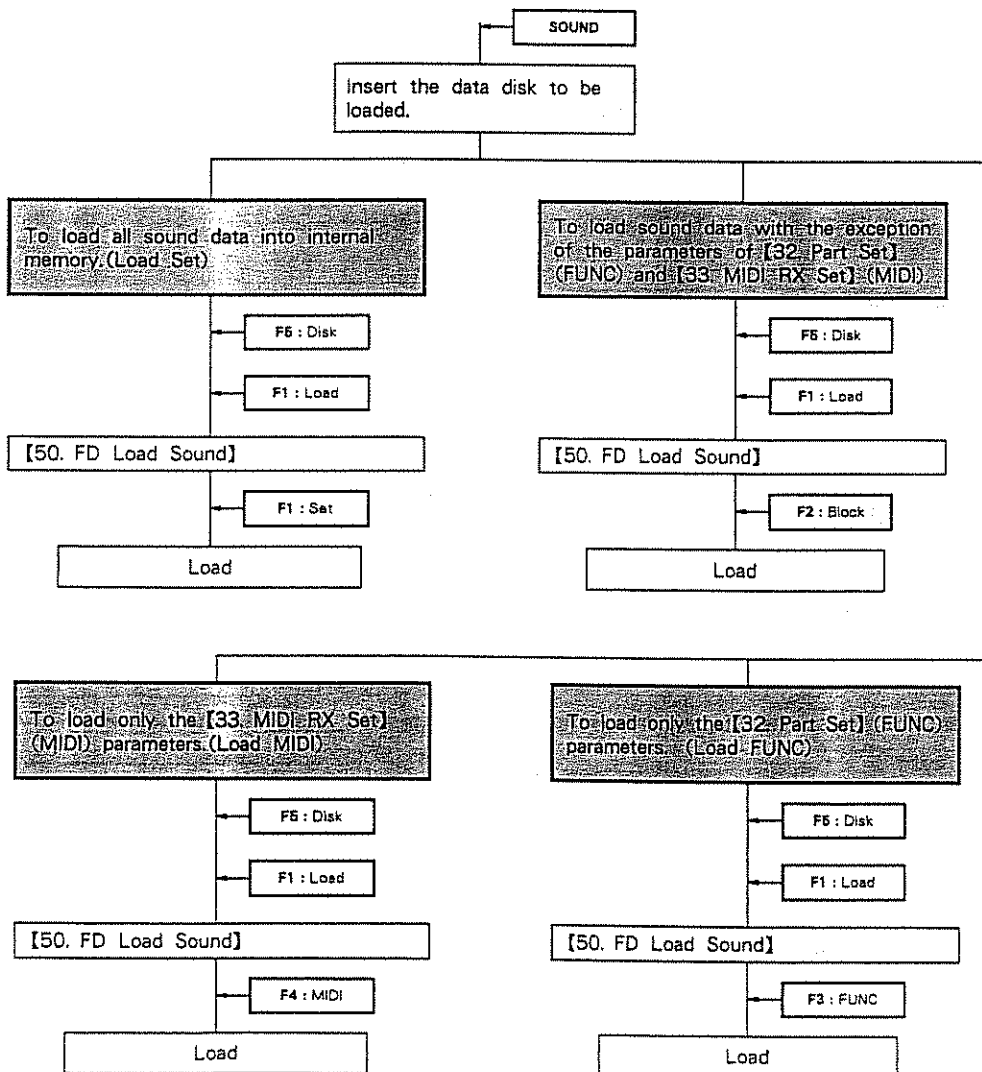
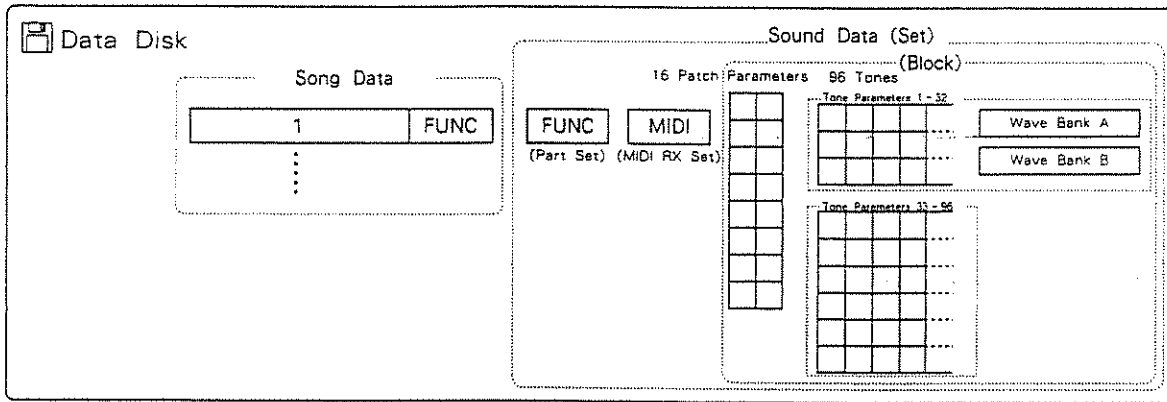

Loading Tones from Data Disks

Tones can be loaded on an individual basis from data disks.

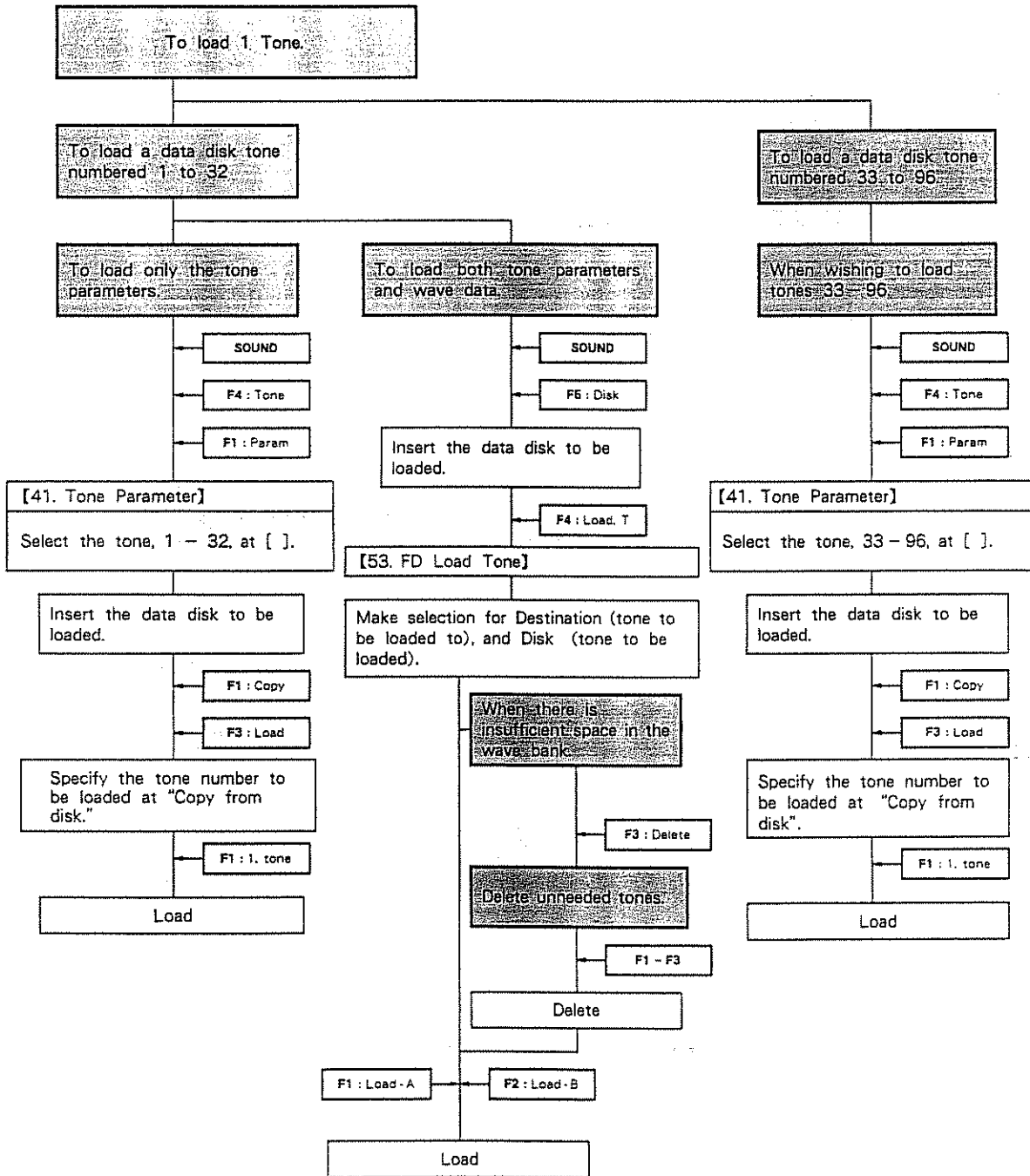

Loading Patches from Data Disks

Patches can be loaded from data disks on an individual basis.

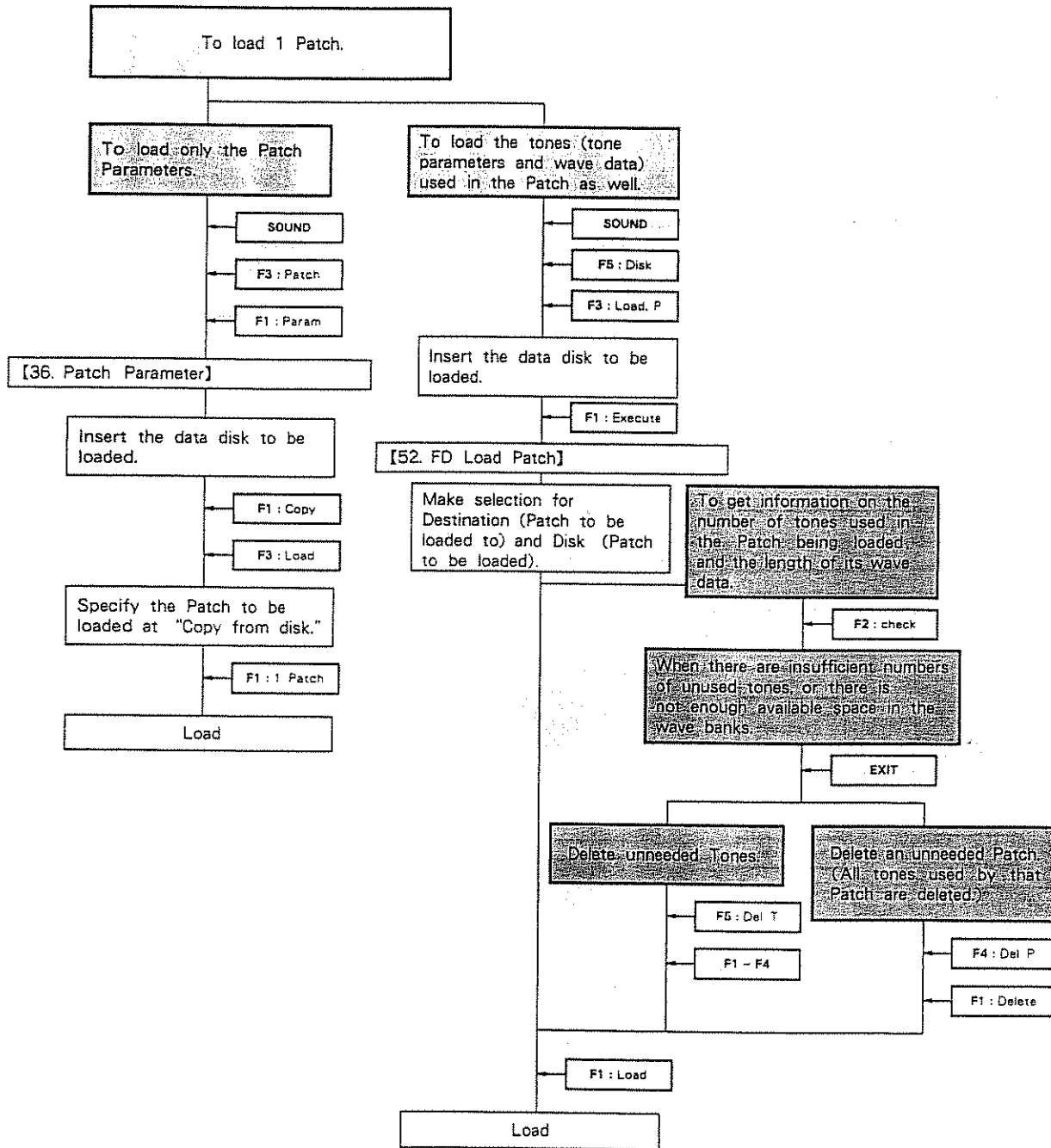

Loading Tones or Patches from the System Disk

Contained on the System Disk are 128 internal wave data-use Tones, and 32 Patches.

When booted, the first half, 64 Tones, are loaded to Tones 33 – 96 in internal memory; and 16 Patch Parameters, the first half, are loaded into Patches 1 – 16.

The following explains how to load those other Patches and Tones lying dormant in the second half of the disk. For a list of the Tones on the System Disk, refer to the supplied Sound Chart.

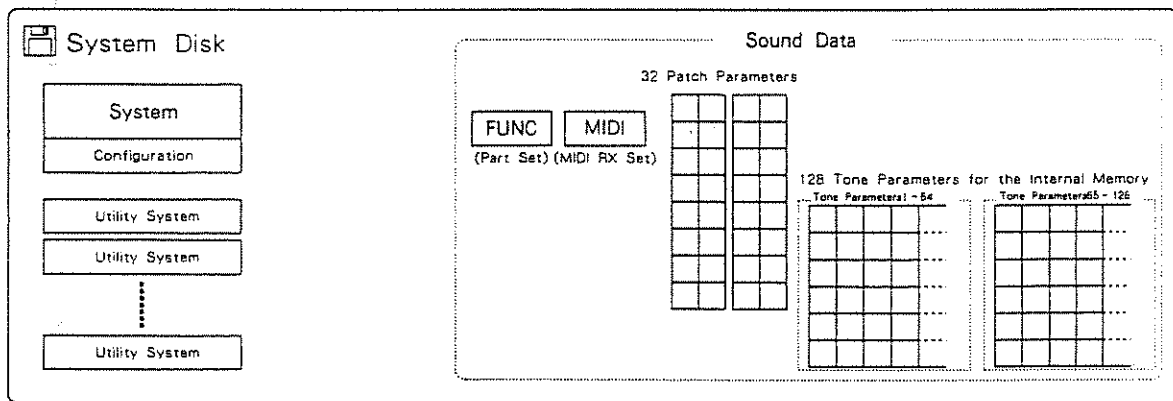

Loading Tones from the System Disk

Tones can be loaded one by one from the system disk. Tones from the system disk are loaded to Tones [33] – [96].

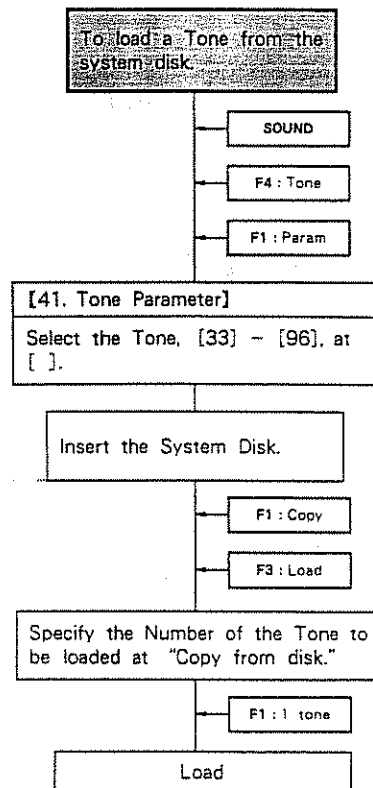

Loading Patches from the System Disk

Patches can be loaded individually from the system disk. The tones split for the patches on the system disk are internal wave-use tones [33] - [96].

When the following method is used to load patches, the Tone Parameters assigned to the patch are loaded as well.

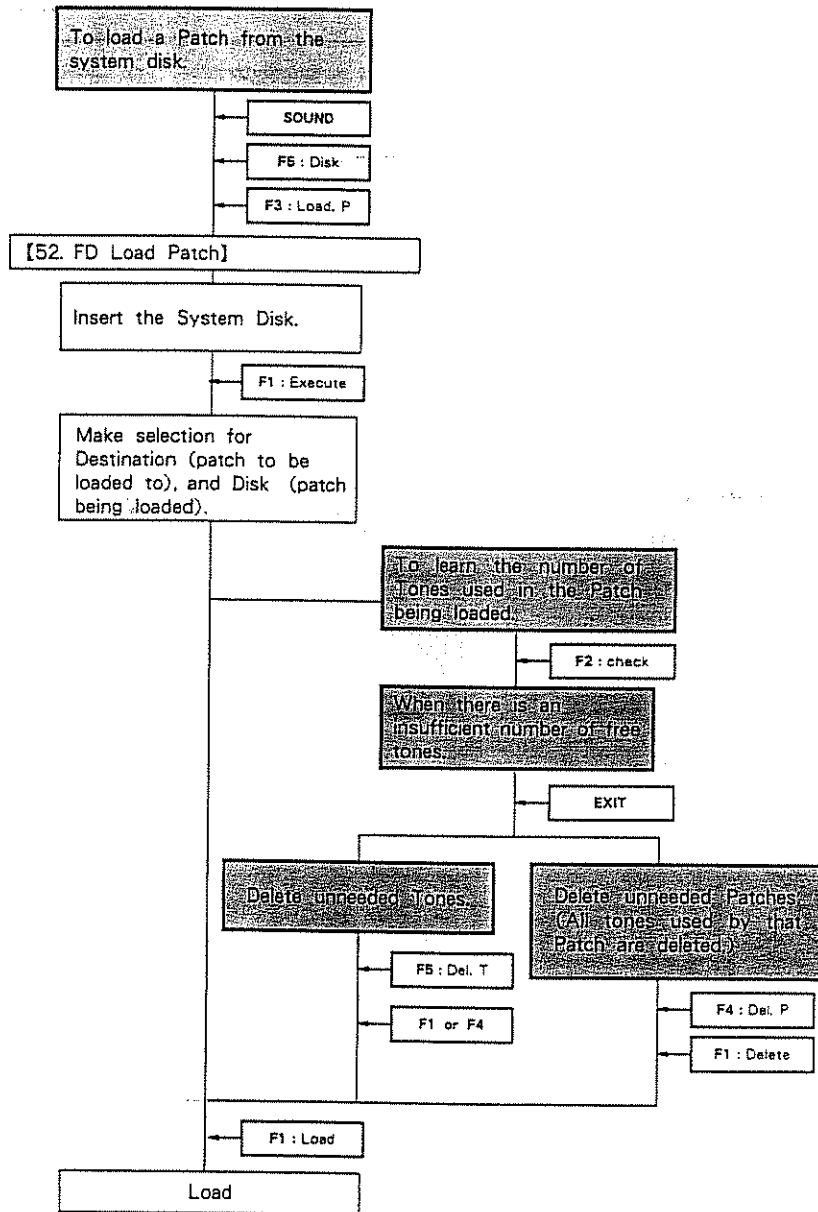

e. Sampling

Connections needed for sampling

Connect the output from a microphone or audio device to the unit's input jack.

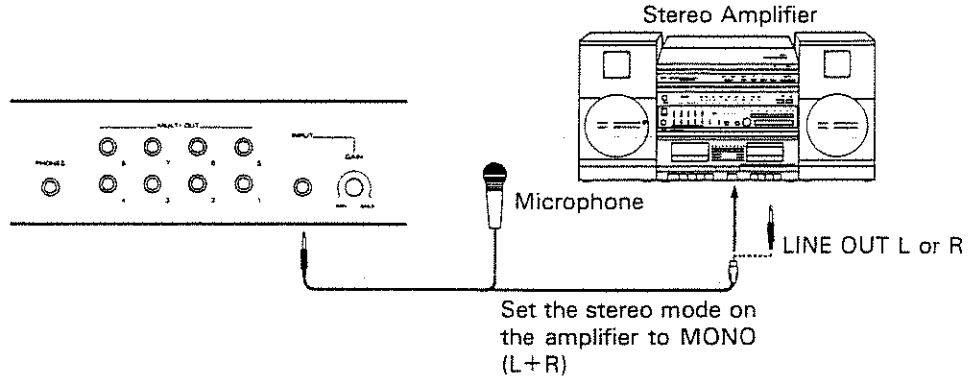

Getting ready to sample

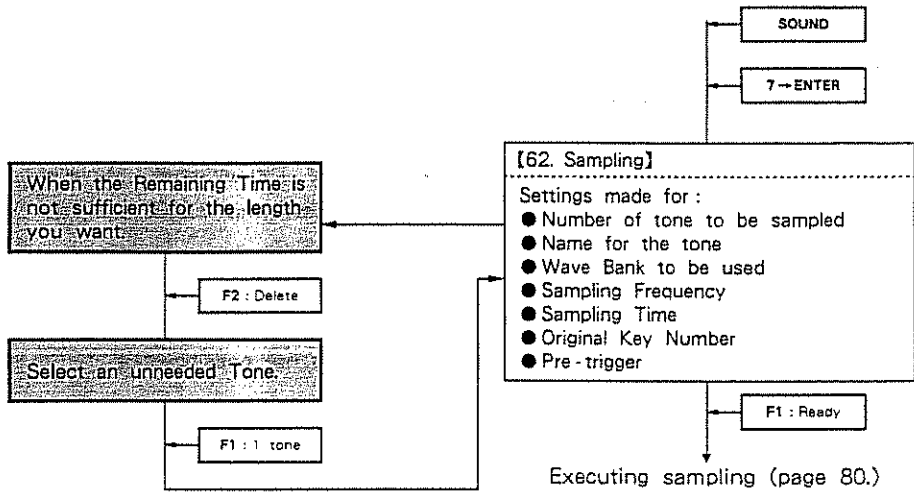

**Wave Banks
(Wave Bank)**

The W-30 has two Wave Banks, A and B where the sampled waves are stored. Each Wave Bank can sample up to 7.2 seconds at the 30kHz sampling frequency. A Wave Bank can be divided into 18 segments, which are 0.4 seconds long at 30kHz sampling, and 0.8 seconds at 15kHz sampling.

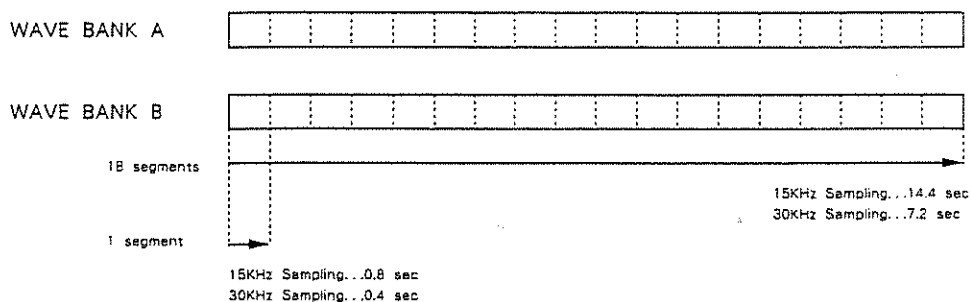

Select either Wave Bank A or B to write the sampled sound.

**Sampling Frequencies
(Freq)**

The sampled sound is recorded into computer memory. A computer can accept information only as digital signals, so the W-30 converts audio signals into digital. It does this by examining (sampling) the incoming signal a great many times a second, and sequentially records this information in computer memory. For example, at 30kHz sampling frequencies, the input signal is divided into 30,000 samples per second. The W-30 offers either 30 or 15kHz sampling frequencies. At the 30kHz sampling frequency, the sampling time is shorter, but the audio quality of the sample is better. On the other hand, at the 15kHz sampling frequency, longer samples are possible, but the audio quality of the sample is slightly lowered.

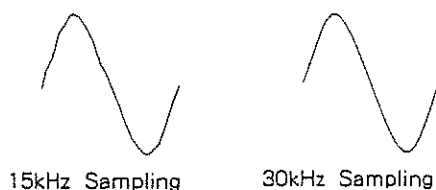

Sampling Time (Time)

This sets the sampling time (in 0.4 second units). You can select up to the maximum sampling time. When the 15kHz sampling frequency is selected, sampling time is multiplied by 2. ("x 2" is displayed.)

*When the maximum available sampling time is longer than you need for the sample, select a longer sampling time to provide some extra leeway. You can cut out unneeded portions of the wave afterwards using [57. Truncate].

**Original Key Number
(Orig.Key)**

The Original Key represents the key at which the original sample is played. When sampling from a musical instrument, you may have to set a Key number that matches the pitch of the sampled sound. Middle C is shown as C4.

*The highest pitch which can be actually played on the W-30 is 2 octaves above the sampled sound. Higher pitches cannot be played.

**Pre-trigger
(Pre-trig)**

Pre-trigger allows you to record the wave data even before it exceeds the threshold level (before the moment sampling starts). In other words, this function begins sampling a little earlier, and thus saves the beginning of the sample from being cut off. "10ms" is about 0.01 seconds. (When the sampling frequency is set to 15kHz, the Pre-trigger time is always shown with x 2.)

*To check if there is free space for sampling, first see page 69.

**Sampling Stand-by
Mode**

When an Original Tone is selected as a destination Tone Number, pressing the **F1** button will cause the display to show "Now Working", indicating that the wave data organization is being processed. When "Ready" appears on the message line, sampling can be started.

**Checking the
Input Level**

With the Sub-window open, adjust the Gain Knob on the rear of the unit so that the input level will be the maximum without the display showing "over".

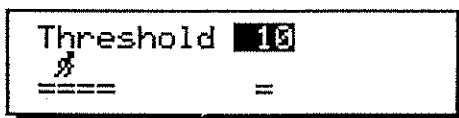

Input signals are output from the Multi Output socket 1 and the Headphone socket for you to monitor. When sampling through a microphone, listen to the sound through headphones; and any connected amplifier should be turned down to avoid howling.

**Sampling Threshold
(Threshold)**

Auto Sampling function starts sampling the moment a signal of a certain level (threshold level) is fed in. When the threshold level is set to zero, the actual sampling starts as soon as the sampling function is executed.

Executing Sampling

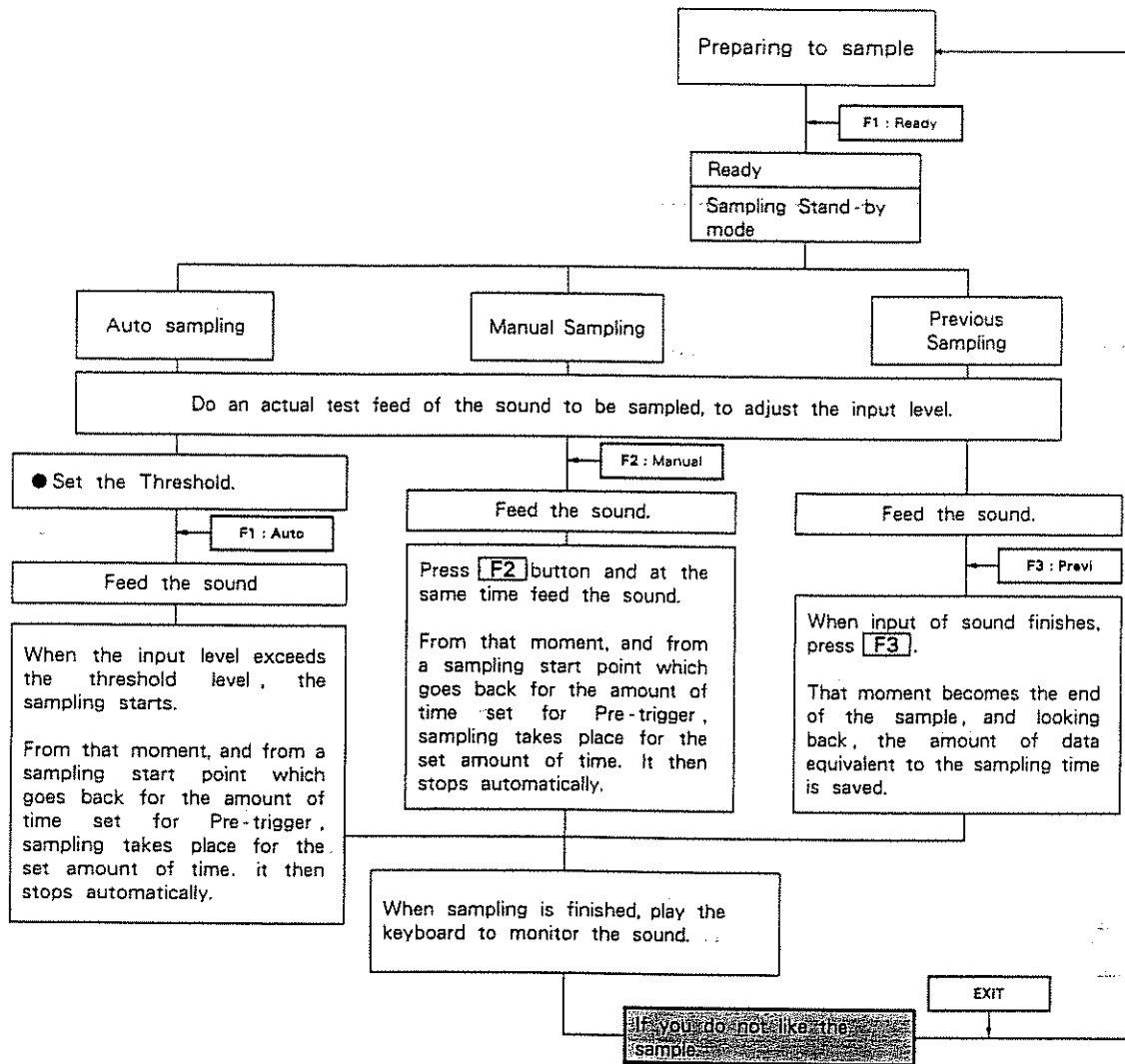

Monitoring the sample

Before making a Tone with the sample, you can play it on the keyboard to hear what it sounds like. Also, in the display, the waveforms can be seen.

*As a result of sampling, Tone Parameters are initialized to their standard settings. (Settings for Orig. Key and Tone Name take on those settings made in the [62. Sampling] screen.) Thus, after sampling, you should clear out unneeded portions of the wave with [57. Truncate], and then set all the Tone Parameters.

7. Writing a Song

a. Recording

Preparing for recording

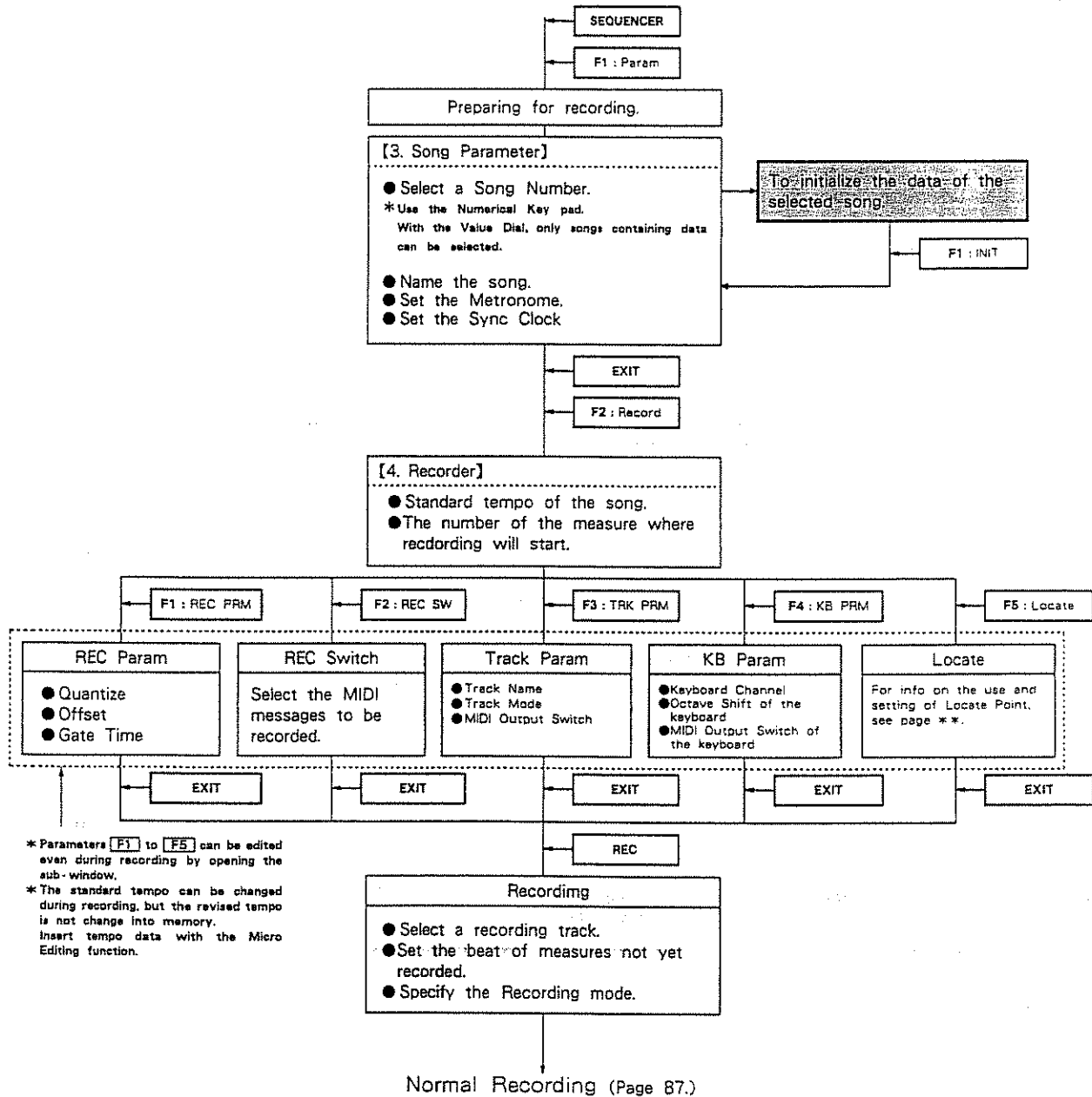

Preparing a sound

Ideally, recording should be performed by playing the sound. This way, the tone or volume can be monitored as you proceed with overdubbing. Prepare a Patch in the Sound Mode, then set the Part Set (P.144).

Press REC in the [4. Recorder] Screen (Recording)**Track**

Specify the track where the recording data is stored.

Beat**(New M. Beat)**

The Beat is governed by the Tempo Track. New M. Beat determines the beat of new measures, ones that have not been recorded before on any track. When recording for the first time, it becomes the beat of the first measure. Once any recording takes place, the measures become fixed at this beat, and cannot be altered afterwards.

Take for example the following song, having 4 measures (the 5th measure is the ending measure.)

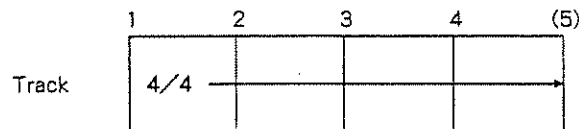

If, under normal recording, you set New M. Beat to 6/8, and starting from the top of the first measure you record up until measure 6, thus erasing any previous data, the beat from the 5th measure on will be 6/8, as shown below. (The 7th measure becomes the ending measure.)

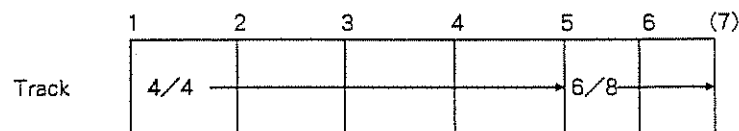

Thus, in this manner, the beat is determined at the time of recording by New M. Beat.

In cases where you want to make a song where you change beat each measure, it is recommended that you first create an empty song.

● **How to record empty measures**

Carry out normal recording, but do not input any performance information. Stop immediately before any points where the beat is to be changed, make a new setting with New M. Beat, then continue recording. Once the empty song is completed, you can then record over again from the top, this time putting in the actual performance information.

● **Inserting empty measures when editing songs**

When editing a song, while specifying the beat in the tempo track (T), you can insert the measures you need. Once you have an empty song, you can record over again from the first measure, while putting in the performance information.

Recording Mode (REC Mode)

There are several methods available for recording songs.

To start with, the Normal Recording and Key On Recording modes are employed. For explanation of other recording modes, see page 88,89.

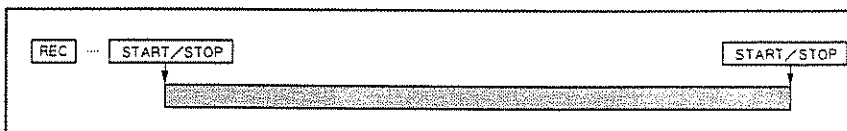

● Normal

With **REC** pressed and the sub-window open, recording begins when you press **START/STOP**. Press **START/STOP** again to stop recording.



● Key On

With **REC** pressed and the sub-window open, recording starts from the moment you play the keyboard. (The same effect as pressing **START/STOP** under Normal Recording.) Also, with **REC** pressed and the sub-window open, if you press **START/STOP** it enters the play condition, and after that when you play the keyboard (reception of note messages starts) recording automatically starts from that moment. Press **START/STOP** again to stop recording.

 Original data
 Newly recorded data

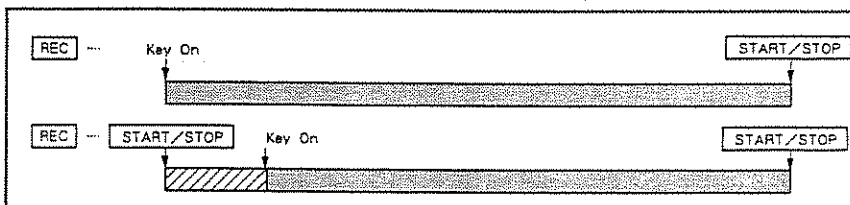

Press **F4** in the [4. Recorder] Screen (KB Param)

Keyboard Channel

Set the MIDI transmit channel of the keyboard.

Octave Shift of the Keyboard

The keyboard is capable of being played over the range of C2 to C7, and can be shifted in units of an octave above or below.

Program Change Number

Determines the Program Change Number transmitted when **F1** is pressed.

I (Keyboard → Internal sound module MIDI switch)

(Local On/Off)

When On, the keyboard's performance data is sent to the internal sound module.

E (Keyboard → MIDI OUT MIDI switch)

When On, the keyboard's performance data is transmitted from MIDI OUT.

Press **F1** in the [4. Recorder] Screen (REC Param)

Quantize

Real-time recording uses a time unit (1 clock tick) that corresponds to $1/96$ of a quarter note (when Quantize is OFF). This function allows you to correct for deviations in timing in the recording by forcing the note positions to align in accord with discrete steps, as selected. You can select any of the following quantization values.

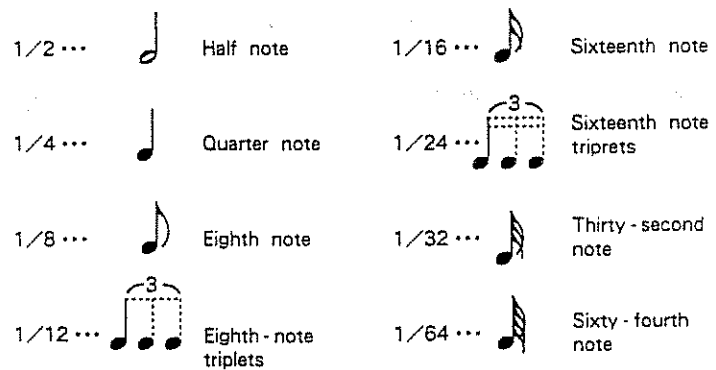

Offset

Offset can shift the timing of quantization forward or backward slightly for recording. The base unit for the offset is 1 clock ($1/96$ of a quarter note). “-” values put it before the beat, while “+” values put it after the beat. It has no effect when quantize is “off.”

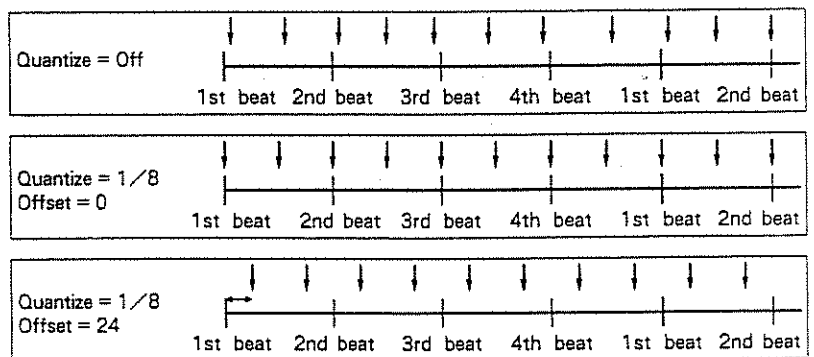

Gate Time

The W-30 allows you to adjust the gate time, the gap between key on to key off. The base unit for the gate time is one clock ($1/96$ of a quarter note). For instance, a value of 96 makes every note a quarter note no matter how long you are pressing the key. The special value [Real] specifies real-time recording, in which the W-30 records each note exactly as it is played.

Press F2 in the [4. Recorder] Screen (REC Switch)

Recording Switch (REC SW)

The memory capacity of the W-30 is limited. Using the pitch bender or aftertouch effect consumes large amounts of memory. To avoid wasting memory, set unnecessary messages to OFF.

- PAf Polyphonic Aftertouch
- C. Chg Control Change
- P. Chg Program Change
- CAf Channel Aftertouch
- Bend Pitch Bender
- Excl Exclusive and Tune Request messages

Press F3 in the [4. Recorder] Screen (Track Param)

Track Name

Each track can be named using up to 8 characters.

Track Mode and MIDI Transmit Switch

Switch to "Mute" using **F3**, and no sound is generated, as Note On messages are not transmitted. Other messages are transmitted.

Switch to "Off" using **F4**, and no messages are transmitted to the internal sound module.

Switch to "Off" using **F5**, and no messages are transmitted to MIDI OUT.

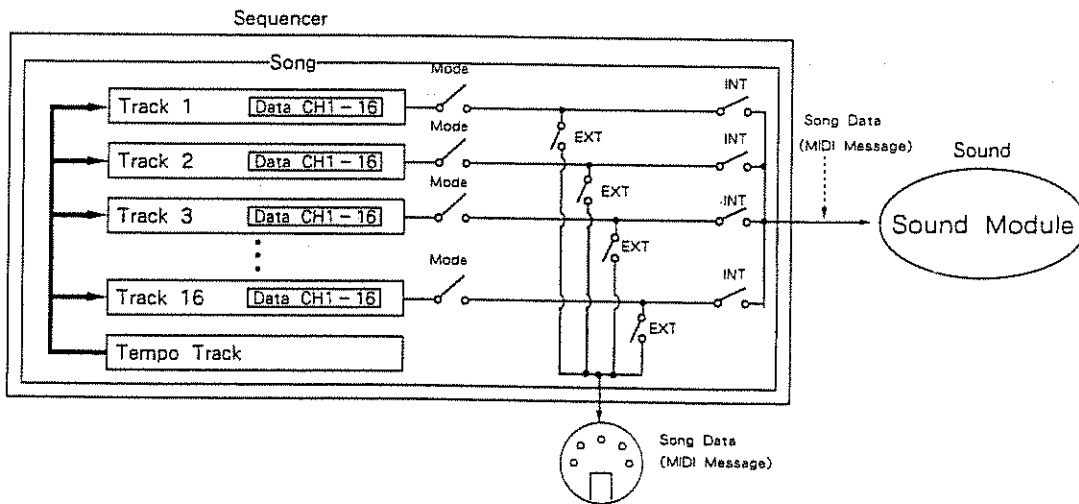

Locate Point

To re-record certain portions of a work, automatic recording can be performed through specifying a REC Start Point and REC End Point. (Auto Punch In/Out) See page 88, 89.

Executing Recording

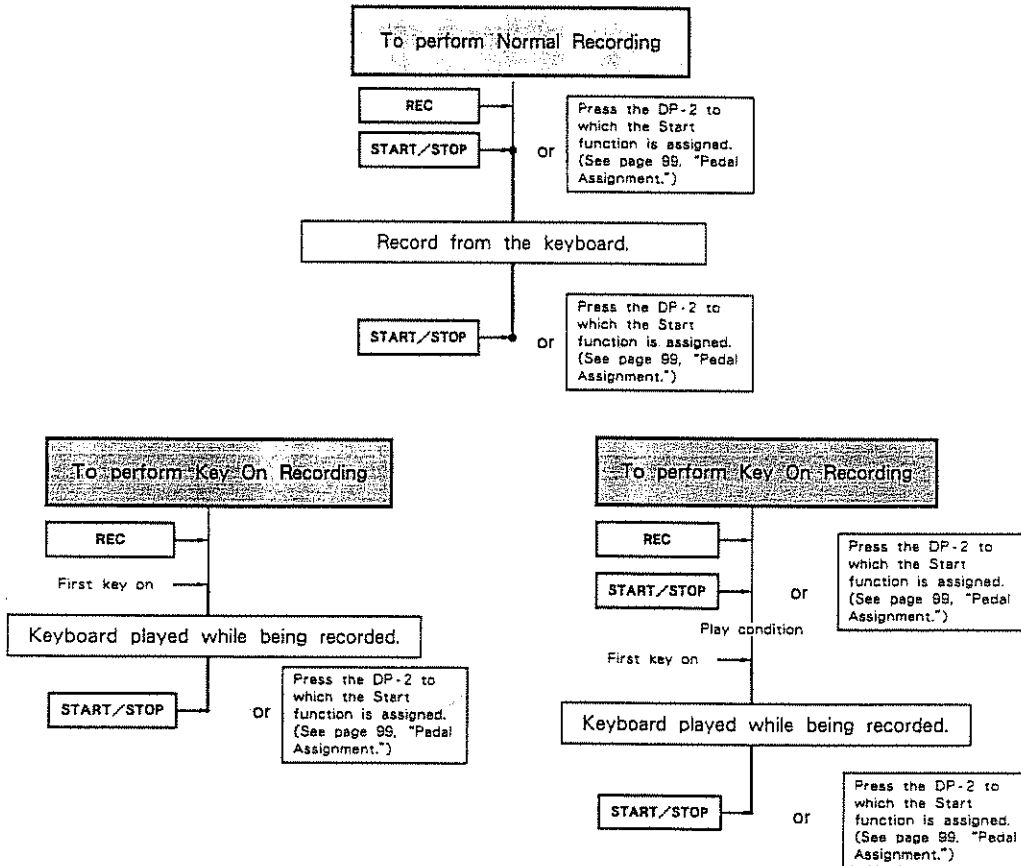

*Although the tempo can be changed during a recording, if you want these changes to included in the recording as actual tempo changes, they need to be inserted as tempo change data in the Tempo Track, in the [5. Micro Edit] screen. (see page 94.)

*When you wish to record while having Program Change messages transmitted, press [F4], and at "P =" specify the Program Change Number, then press [F1] (see page 57).

[4. Recorder] Screen

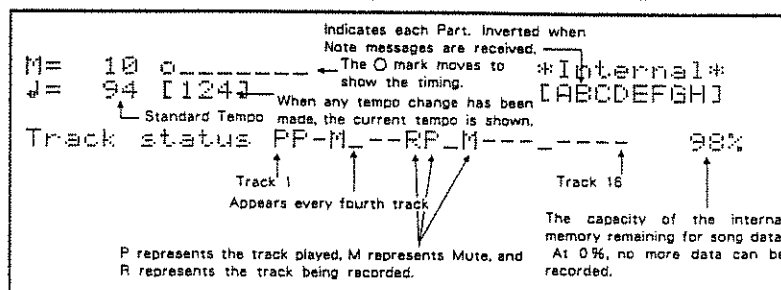

b. Re-recording portions of data

Recording Mode

Select the Recording Mode that suits your purpose. ([REC] in the [4. Recorder] screen)

● Normal

With [REC] pressed and the sub-window open, recording begins when you press [START / STOP]. Press [START / STOP] again to stop recording.



● Key On

With [REC] pressed and the sub-window open, recording starts from the moment you play the keyboard. (The same effect as pressing [START / STOP] under Normal Recording.) Also, with [REC] pressed and the sub-window open, if you press [START / STOP] it enters the play condition, and after that when you play the keyboard (reception of note messages starts) recording automatically starts from that moment. Press [START / STOP] again to stop recording.

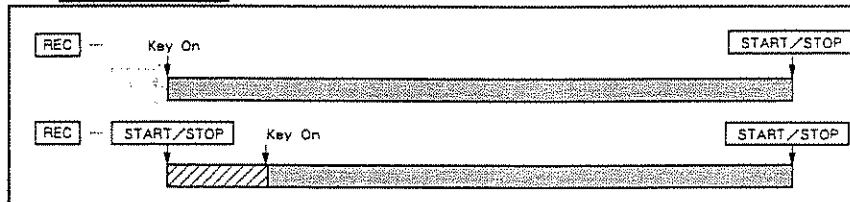

● Auto Punch IN/OUT (Punch I.O)

The region to be re-recorded is specified beforehand in terms of a REC Start Point (0) and REC End Point (9). After pressing [REC], thus opening the sub-window, [START / STOP] is pressed to enter the play condition. Thereafter, when the REC Start Point is reached, recording starts. When the REC End Point is reached, it returns to the play condition. Pressing [START / STOP] will stop it.

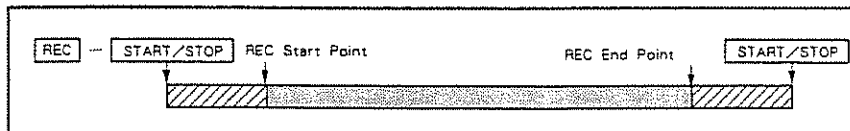

● Auto Punch IN (Punch IN)

The point where recording is to start is specified beforehand with REC Start Point (0). Press [REC] and the sub-window will open. Then, when [START / STOP] is pressed it enters the play condition. When the REC Start Point is reached, it goes into record. When [START / STOP] is pressed again, it stops.

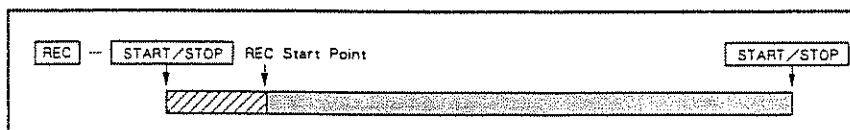

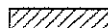
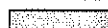
 Original Data
 Newly recorded data

● Auto Punch OUT (Punch OUT)

The point where recording is to finish is specified beforehand with REC End Point (9). Press **REC** and the sub-window will open. Then, when **START/STOP** is pressed it starts recording. Thereafter, when the REC End Point is reached it enters the play condition. When **START/STOP** is pressed again, it stops.

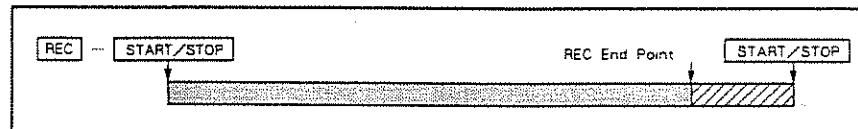

● Manual Punch IN/OUT (Punch MAN)

With **REC** pressed and the sub-window open, it enters the play condition when you then press **START/STOP**. Thereafter, recording starts the moment you press **REC**. When you press **REC** again, it returns to the play condition. When **START/STOP** is pressed, it stops.

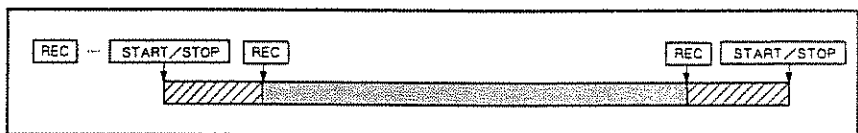

● Loop

The region to be re-recorded is specified beforehand by means of REC Start Point (0) and REC End Point (9). Then, after pressing **REC** and opening the sub-window, press **START/STOP**. It will jump to the REC Start Point and start recording. When the REC End Point is reached, it returns to the REC Start Point and continues recording. When **START/STOP** is pressed it stops.

*With Loop recording, allow more than one measure between the REC Start Point and REC End Point.

 Original data
 Newly recorded data

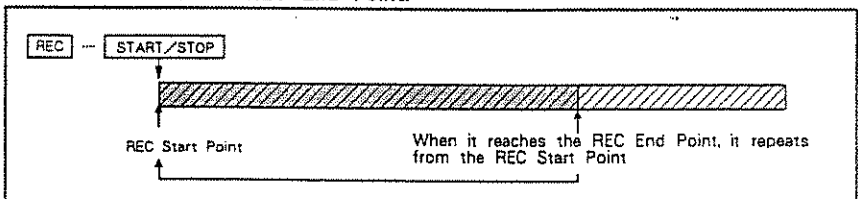

Pressing **REC** is equivalent to depressing a DP-2 which has manual punch in/out assigned to it.

Pressing **START/STOP** is equivalent to depressing a DP-2 which has Start/Stop assigned to it.

*During Loop recording, it records alongside existing data on the track, so no data in the recording track is erased. In other recording modes, the existing data on the track is erased.

*When recording a song, each pressing **REC** makes Punch IN/OUT regardless of REC Mode.

Locate Points

When Auto Punch, or Loop recording are chosen as recording modes, you need to specify a REC Start Point and REC End Point.

*With Loop recording, provide for more than one measure between the REC Start Point and REC End Point.

In addition, 8 User Points can be determined. Specified Locate Points can be jumped to as required. This can be convenient for easily finding the beginning of certain important phrases once a User Point has been set.

Available Locate Points	0 : REC Start Point
	1 : User Point 1
	2 : User Point 2
	3 : User Point 3
	4 : User Point 4
	5 : User Point 5
	6 : User Point 6
	7 : User Point 7
	8 : User Point 8
	9 : REC End Point

*Positions that you set do not need to correspond to the numerical order of the User points.

To set a Locate Point and jump

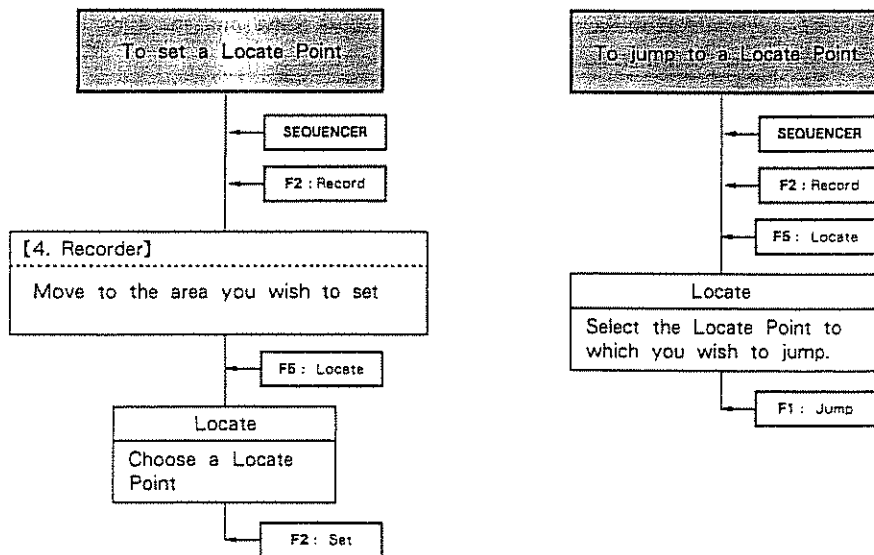

*Also, during song play, [F5]: Locate can be pressed, opening the sub-window; and at the moment you wish to make setting for, press [F2]: Set.

*Jumps cannot be made during the play of a song.

Recording the next track

Once the recording of one track is completed, you can go on to record the next, for another part.

Change the MIDI channel of the keyboard to one conforming to "the part you are going to record next." The recording track is changed, and recording is then carried out.

You can listen to tracks recorded previously while recording subsequent tracks.

e.g.)

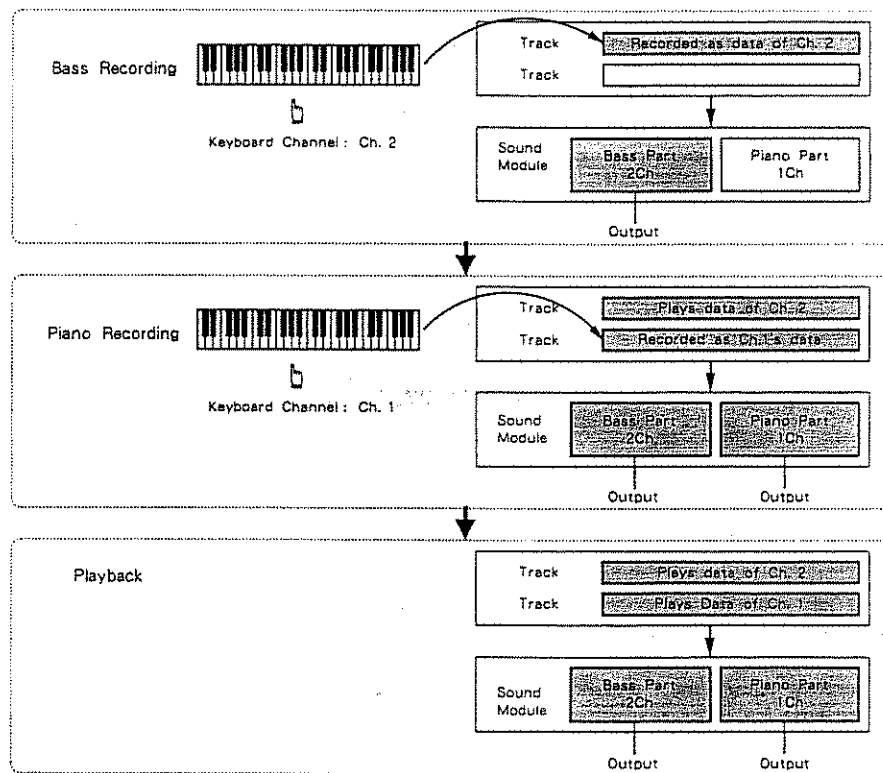

c. Micro Editing

Micro Edit allows you to perform detailed edits on individual MIDI events.

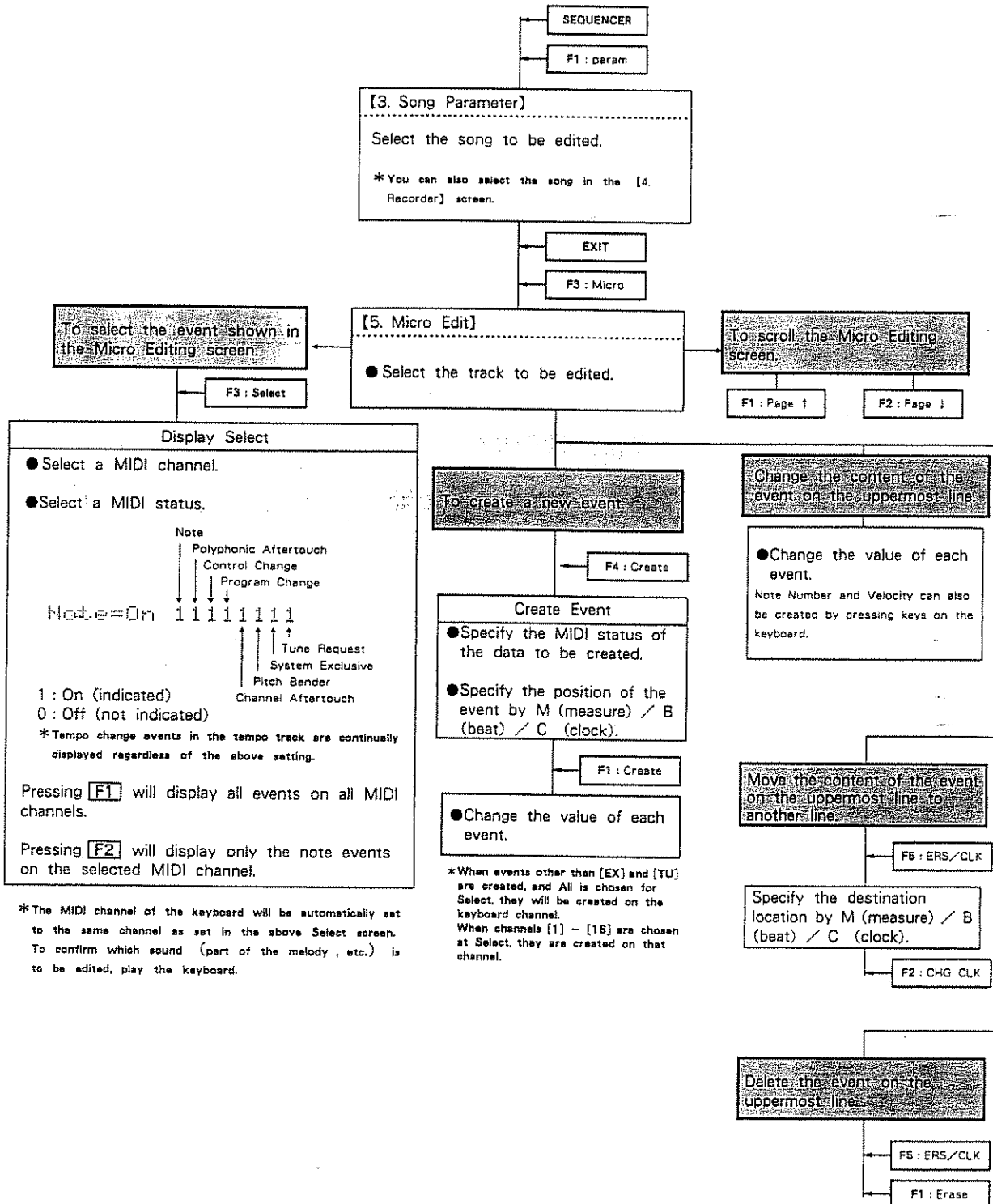

Scrolling Data

Select a track.

Move the cursor here and rotate the Value dial, and measures move up or down.

Move the cursor here and rotate the Value dial, and events move up or down.

```

Track 1 -CLK-Ch--Note NO.--Vel--Gate
M 20 1 E 5 76 58 40
 53 1 C 4 60 56 45
( 2)- 53 1 C 5 72 71 35
==== Meas 2 (Beat 4/ 4) ====
( 1)- 10 1 C 5 72 64 49
    
```

Move the cursor here and rotate the Value dial, and beats move up or down.

Location of Events

The position of each item of MIDI data (event) is identified by measure number, beat number and clock pulse.

Indicates the measure number.

Indicates the clock pulse within the beat
Clock : , = 96 (0 - 95)

```

Track 1 -CLK-Ch--Note NO.--Vel--Gate
M 20 1 E 5 76 58 40
 53 1 C 4 60 56 45
( 2)- 53 1 C 5 72 71 35
==== Meas 2 (Beat 4/ 4) ====
( 1)- 10 1 C 5 72 64 49
    
```

Indicates the beat within the measure

Event Indication

Each MIDI message written in a song is termed as an event. There are numerous types of events, as shown in the following :

Note	MIDI Ch	Note No.	Velocity	Gate
	MIDI Channel	Determine Pitches	Determine volume	Determine gate time
	1 - 16	(C-1) - G9(0-127)	1 - 127	1 - 65535
PAf Polyphonic Aftertouch	MIDI Ch	Note No.	Value	
	MIDI Channel	Note number	Specify values	
	1 - 16	(C - 1) - G9, (0 - 127)	0 - 127	
C. Chg Control Change	MIDI Ch	No.	Value	
	MIDI Channel	Control Change number	Specify values	
	1 - 16	0 - 127 (121 - 127 are Mode messages)	0 - 127	
P. Phg Program Change	MIDI Ch	Value		
	MIDI Channel	Specify values		
	1 - 16	1 - 128		
Channel Af (CAf) Channel Aftertouch	MIDI Ch	Value		
	MIDI channel	Specify values		
	1 - 16	0 - 127		
Bender (Bend) Pitch Bender	MIDI Ch	Value		
	MIDI channel	Specify values		
	1 - 16	(- 8192) - 0 - 8191		
Exclusive (EX) System Exclusive	The sub-window can be opened to perform edits, but you are limited to a maximum of 500 bytes. (F0 means start and F7 means end.) Move the cursor to the Manufacturers-ID to open the sub-window.			
Tune Request (TU)	No parameters exist			
Tempo Change (Tempo)	Set as an absolute in the range of 5 to 500. Memorized as its ratio in respect to standard tempo. *This is indicated only in the tempo track.			

d. Writing Tempo Change

To write tempo changes for a song, write the tempo change data in the Micro Editing screen.

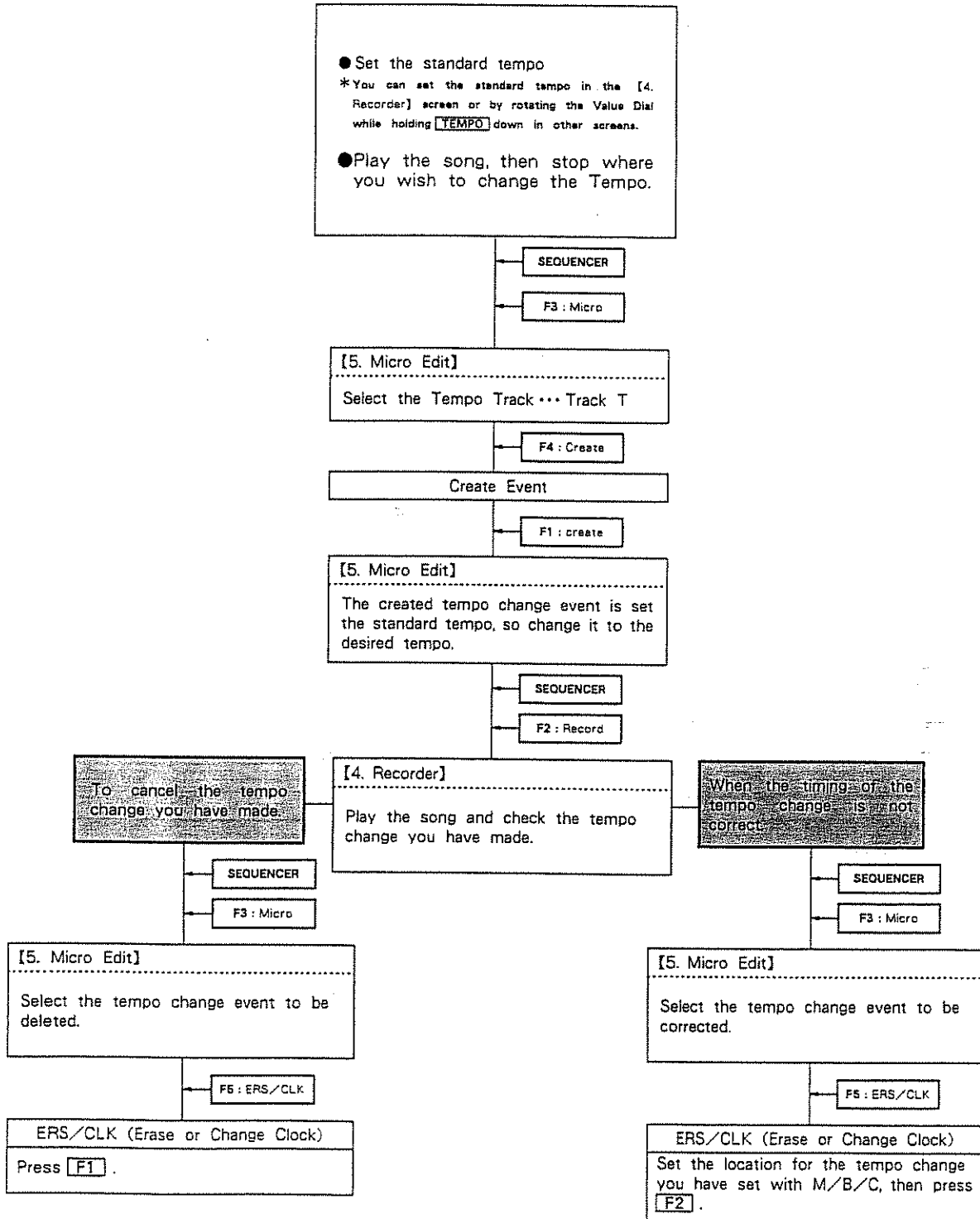

Specifying a Track

To specify the track to be edited, do as follows :

- [1]-[16] : Specify one of the phrase tracks.
- [T] : Specify the tempo track.
- [1-16] : Specify all the phrase tracks.
- [All] : Specify all the phrase tracks and the tempo track.

Specifying a Measure

To specify the measures to be edited, specify "from which measure and for how many measures".

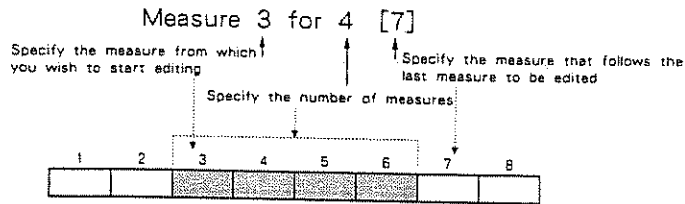

Specifying the MIDI Status and the range

When you can specify the type of event (status) to be edited, Status appears in the screen. In such cases, MIDI status messages can be selected as follows :

MIDI Status	Range
All	All the MIDI Statuses
Note (Note)	Note Number (0 - 127)
PAf (Polyphonic Aftertouch)	Note Number (0 - 127)
C. Chg (Control Change)	Control Change Number (0 - 127)
P. Chg (Program Change)	Program Change Number (1 - 128)
CAf (Channel Aftertouch)	(The range cannot be set)
Bend (Pitch Bender)	(The range cannot be set)
EX (System Exclusive)	(The range cannot be set)
TU (Tune Request)	(The range cannot be set)

*To set the range of Note, PAF, C. Chg or P.Chg, press **F1** to open the sub-window.

*The range for Note can also be input by pressing keys on the keyboard.

Notes on Song Editing

*Before performing song edits, save the song data onto a disk, because the original song data may become irretrievable after being edited.

*The full range of song editing functions is not available when working between two different songs.

*One song can store up to 9,998 measures.(9,999th becomes an ending measure.)

f. Check of the Song Data

Check of the Track where data is written

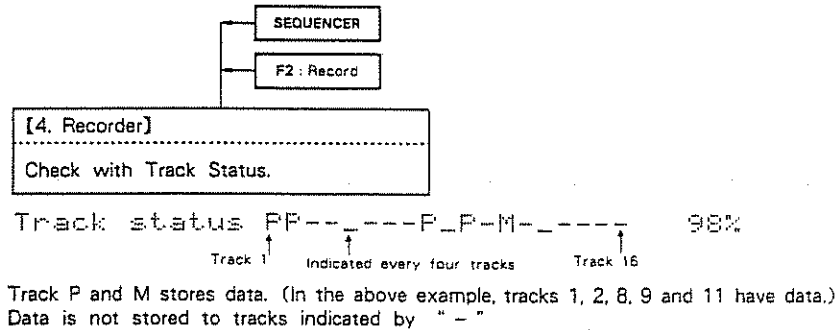

Track Indication

You can check what kind of data is written in any track of any song.

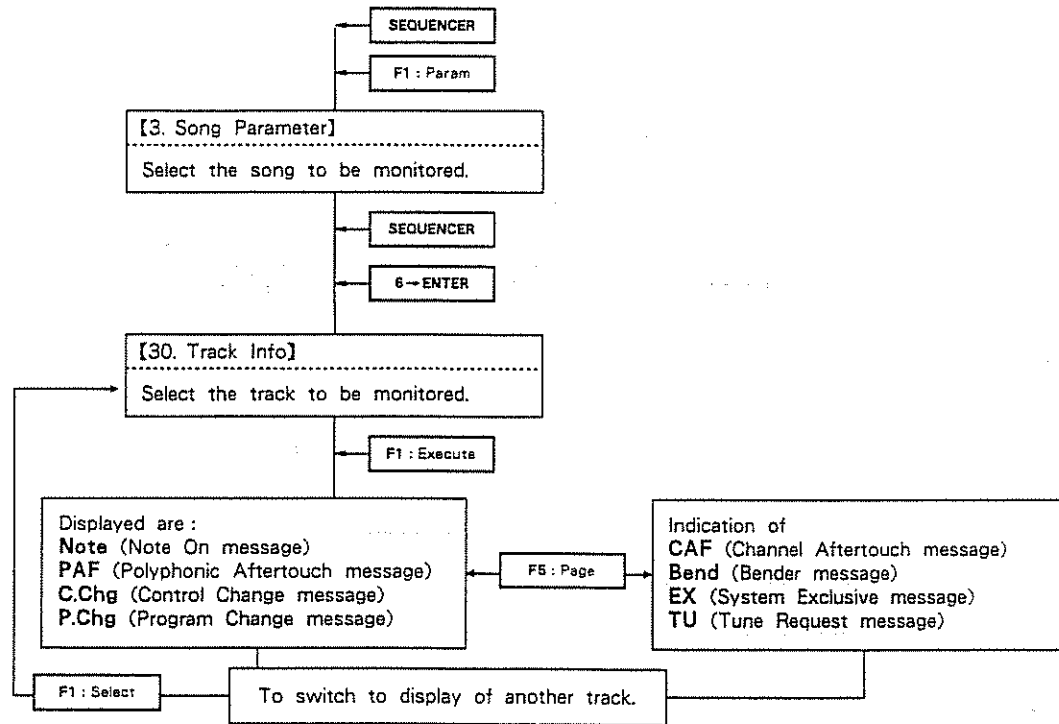

“*” means that data for that type of event exists in the MIDI channel and track you have selected. “.” means that data for that type of event does not exist in the MIDI channel and track you have selected.

MIDI Channel	Track	1	2	3	4	5	6	7	8	9	0	1	2	3	4	5	6
30. Track	1	*
Note		*
PAF	
C.Chg		*
P.Chg		*	*	*
Select.		---	---	---	---	---	---	---	---	---	---	---	---	---	---	---	Page

*Since EX and TU are not channel messages, Exist is shown when there is data, and Not Exist when there is no data there.

8. Saving Data onto a Disk

When you have programmed song and sound data on the W-30, save it onto a data disk.

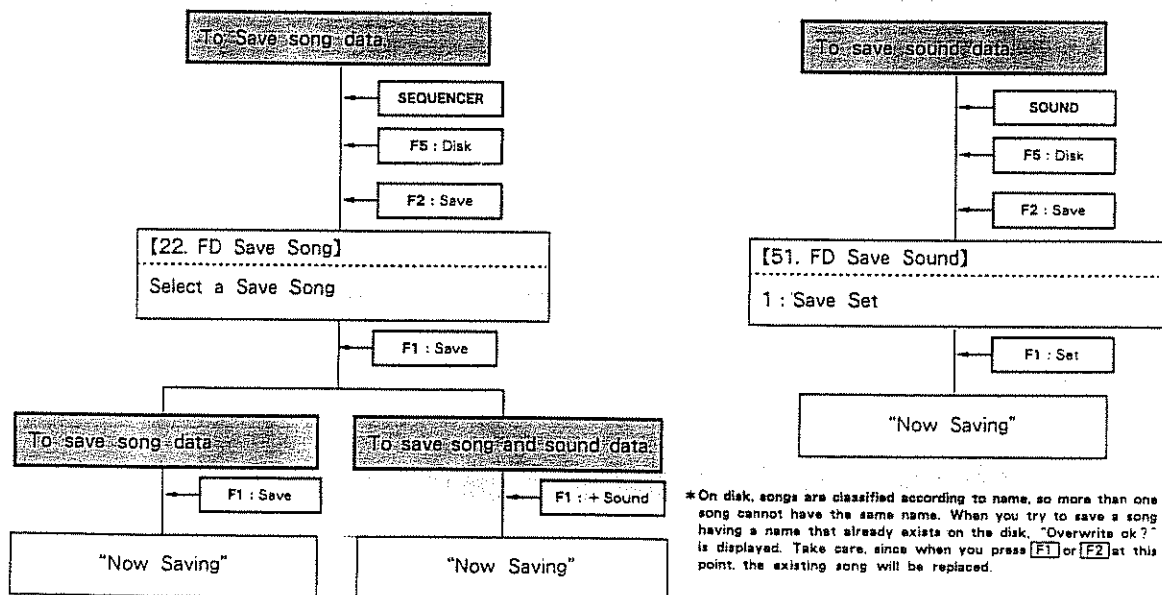
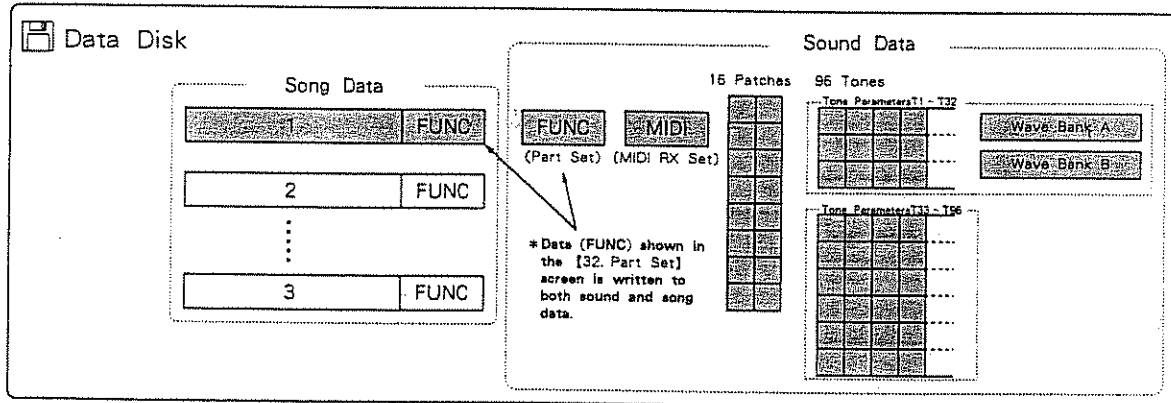
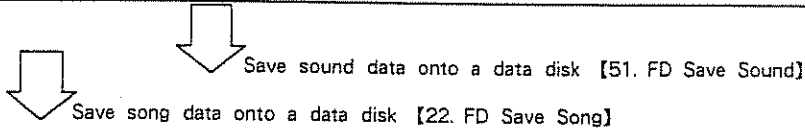
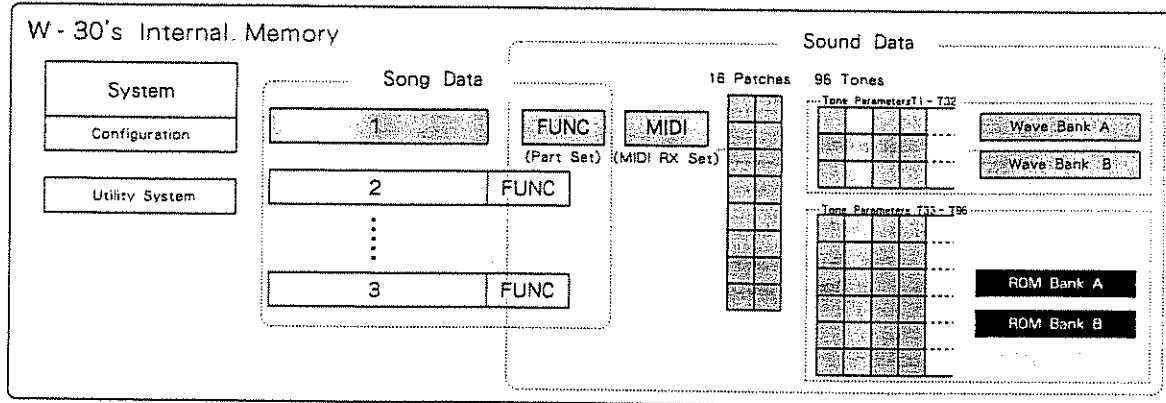

* On disk, songs are classified according to name, so more than one song cannot have the same name. When you try to save a song having a name that already exists on the disk, "Overwrite ok?" is displayed. Take care, since when you press [F1] or [F2] at this point, the existing song will be replaced.

9. Pedal Control (Pedal Assignment)

You can connect a pedal switch to the rear of the unit.

Pedals which can be used

DP-2 Socket : Pedal Switch DP-2, Foot Switch FS-5U

EV-5 Socket : Expression Pedal EV-5, EV-10



DP-2



EV-5

DP - 2

[Hold] Pressing the pedal will sustain the sound. (While the pedal is being pressed, the Note On state is retained. MIDI Control Change No. 64.)

[Punch] When pressed during recording of a song, it puts the unit into playback ; and when pressed again, recording starts. Punch in or out can be accomplished with each press of the pedal. Its performance is identical to that of the **REC** button during recording. (It functions the same regardless of the recording mode.)

[Start] The pedal functions just like the **START/STOP** button.

EV - 5

[C.Chg #] Pressing the pedal transmits the MIDI Control messages, Nos. 0 to 95, you have set. The value of the message varies depending on how you press the pedal.

*The W-30's Internal Sound Module can receive the following Control Change messages.

- No.1 Modulation
- No.2 Breath Controller
- No.7 Volume
- No.64 Hold 1

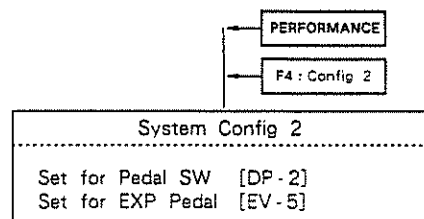

10. Using data created on other models on the W-30

With the W-30, data created on other models can be loaded for use.
The variances in content found with such data is as shown below.

Song Data

Data to be loaded	Difference with respect to the W-30		
	Disk	W-30	Procedures
SYS-503 (S-50) SYS-333 (S-330) SYS-553 (S-550) ([26. Load S Song]) (see page 139.)	Song names : 44 characters	Song name : 28 characters	The 29th character onwards in a song name is ignored.
MRC-500 (MC-500/300) MRC-300 (MC-500/300) ([25. Load MRC Song]) (see page 138)	Phrase tracks : 4 Rhythm tracks : 1	Phrase tracks : 16	Data for the rhythm track is loaded to phrase track 5.
Super-MRC (MC-500/300) ([25. Load MRC Song]) (see page 138.)	Phrase tracks : 8 Rhythm track : 1	Phrase tracks : 16	Data for the rhythm track is loaded to phrase track 9.

Sound Data

Data to be loaded	Difference with respect to the W-30		
	Disk	W-30	Procedures
S-50 Sound Data (Ver.1), (Ver.2) (SYS-503 Type A) ([54. Load/Save S - 50]) (see page 170)	Part : 4 (Ver. 2 SYS-503 Type A) (voice group)	Part : 8	Parts E - H on the W-30 are initialized.
	Part : 1 (with Ver.1) (voice group)		Parts B - H on the W-30 are initialized.
	Patches : 8	Patches : 16	Patches 9 - 16 on the W-30 become nonexistent.
	*Some change in the sound may be noticed as a result of differences in parameters, such as TVF, on different models. Parameters which are not supported are put to their initialized values.		
S-330 Sound Data (Ver.1) S-550 Sound Data (Ver.1) ([50. FD Load Sound]) (see page 166.)	*Due to differences in internal processing, slight changes in tone may occur.		

11. Converting W-30 data for other models

Data created on the W-30 can be saved in the format of other models, for use with such other models. Instances where the content of data will be different are as shown below.

Song Data

Disk to be saved	Difference compared to W-30		
	W-30	Disk	Procedures
Super-MRC (MC-500/300) ([27. Save S-MRC Disk]) (see page 140.)	Phrase tracks : 16	Phrase tracks : 8 Rhythm track : 1	The W-30's Phrase tracks 9 - 16 are ignored.
	Song name : 28 characters	Song name : 13 characters	The 14th character onwards in a W-30 name is ignored.

Sound Data

Disk to be saved	Difference compared to W-30		
	W-30	Disk	Procedures
S-50 Sound Data (Ver.2) (SYS-503 Type A) ([54. Load/Save S-50]) (see page 170.)	Parts : 8	Parts : 4 (Voice group)	The W-30's Parts E - H are ignored.
	Patches : 16	Patches : 8	The W-30's Patches 9 - 16 are ignored. Also, the settings for FUNC for patches 9 - 16 are considered as Patch 1.
	Tones : 96	Tones : 32	The W-30's Tones 33 - 96 are ignored. Also, those keys to which, as a result of Patch Split, are assigned Tones 33 - 96 become T11, for both 1st and 2nd.
*Some change in the sound may be noticed as a result of differences in parameters.			
S-330 Sound Data (Ver.1) S-550 Sound Data (Ver.1) ([51. FD Save Sound]) (see page 167.)	Tones : 96	Tones : 32	The W-30's Tones 33 - 96 are ignored. Also, those keys to which, as a result of Patch Split, are assigned Tones 33 - 96, revert to their nonassigned state (Off), and thus produce no sound.
*Due to differences in internal processing, slight changes in tone may occur.			

*Disks in the W-30 format cannot be used with other models. (S-50, S-330, S-550, MRC-500, MRC-300, and Supe-MRC)

12. Using External MIDI Devices

- a. To play an external sound module connected to the MIDI OUT socket.

Connections

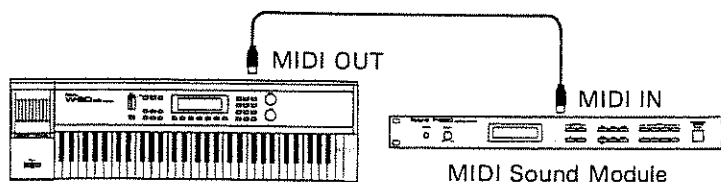

- To play an external MIDI sound module from the keyboard

Set the MIDI transmit channel of the keyboard, then set the MIDI Switch to ON so that performance messages from the keyboard can be transmitted from the MIDI OUT.

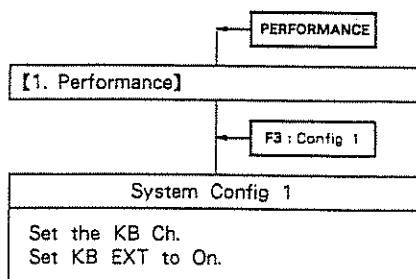

*Set the receive channel on the sound module connected to the MIDI OUT to the same number as the transmit channel of the keyboard.

- To play an external MIDI sound module from a sequencer

Set the MIDI Switch of the track to ON so that the sequencer messages can be transmitted from the MIDI OUT.

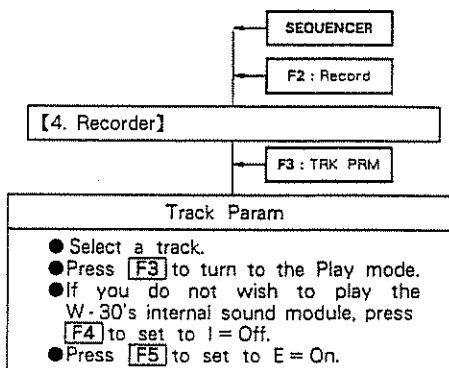

To check the track or MIDI channel used in the song, (See page 97)

*Set the MIDI channel of the sound module connected to the MIDI OUT to the same number as the transmit channel of the sequencer.

b. Using a MIDI Controller connected to MIDI IN

Connections

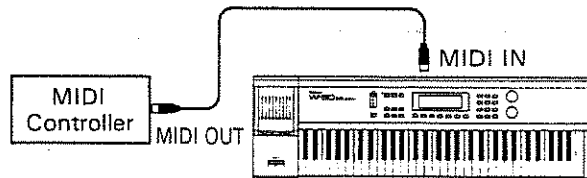

- To play the internal sound module with the messages fed

Set the MIDI Switch to ON so that the internal sound module can be played by the external MIDI messages.

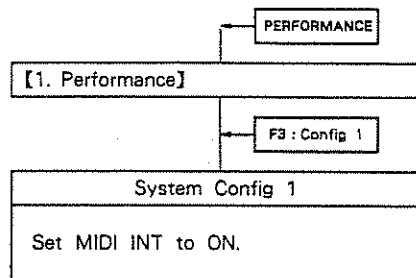

- To turn the SOFT THRU on

To turn on the Soft Thru function (transmitting an exact copy of the messages received at MIDI IN to MIDI OUT), do as follows :

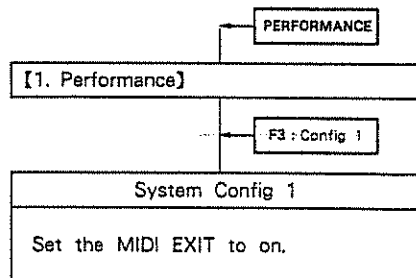

c. Sync to External MIDI Device

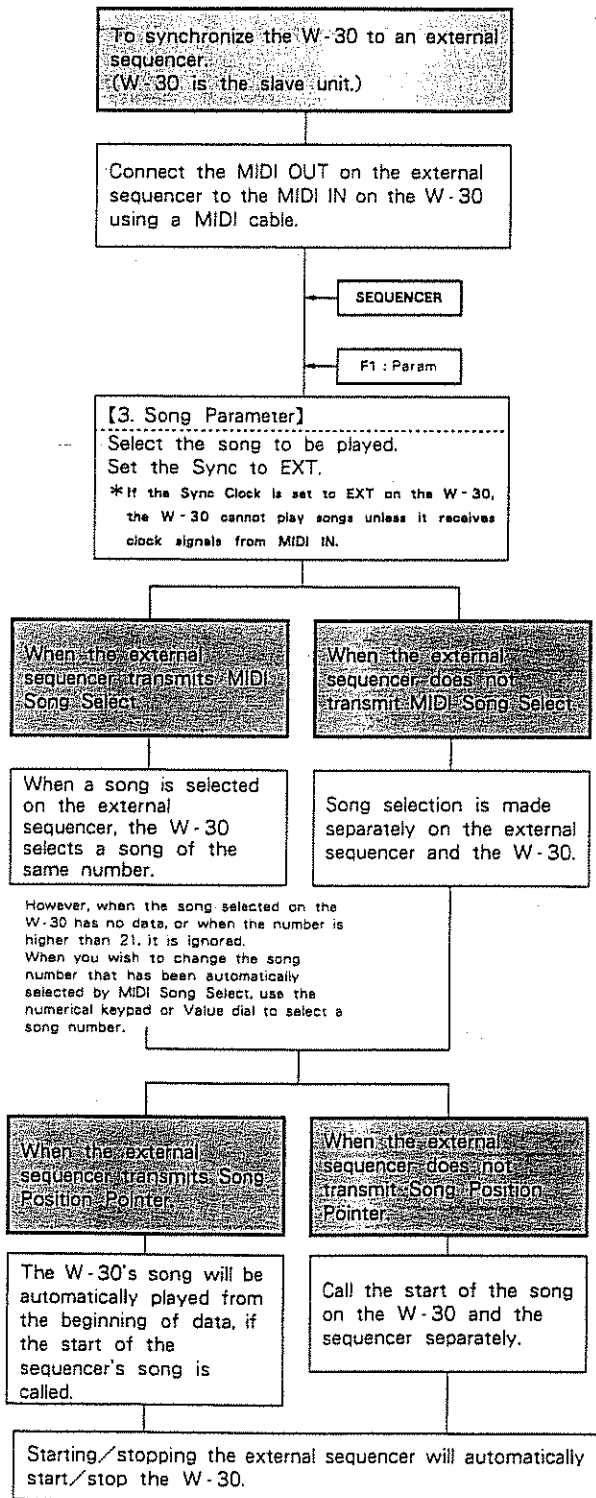

*When you do not wish the W-30 to play in accord with the external sequencing data, press [F3] in the [1. Performance] screen and set the MIDI INT switch to Off.

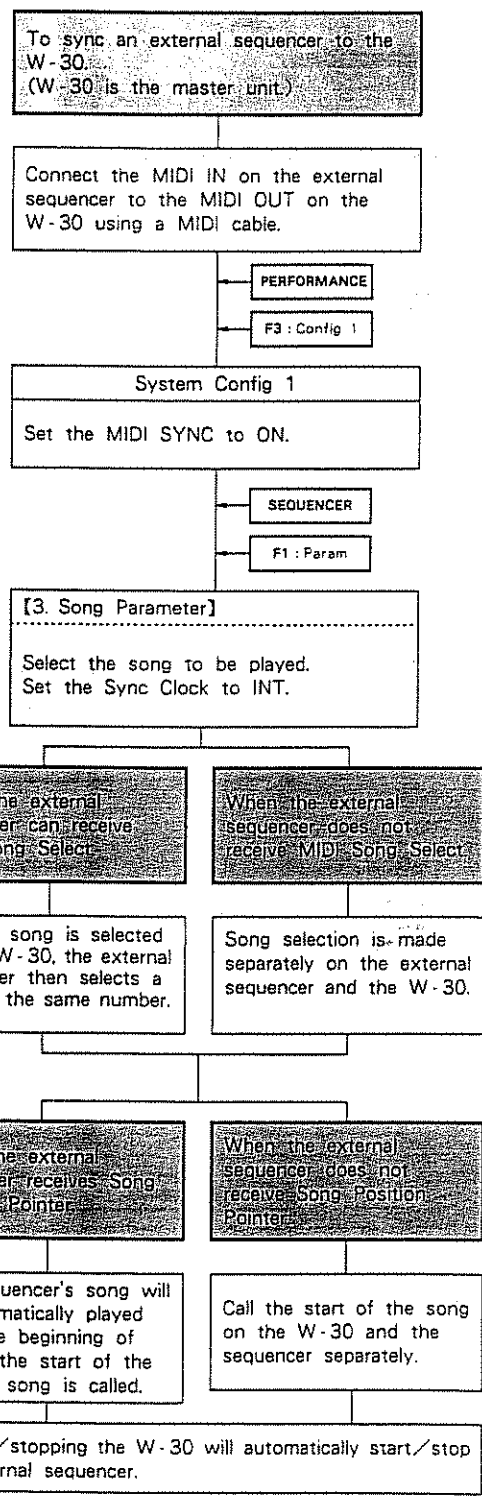

*If you do not wish to transmit the W-30's song data from the MIDI OUT, set the MIDI EXT Switch (TRK PRM E=) in each track to Off in the [4. Recorder] screen.

d. Recording while Synchronized to an External MIDI Sequencer

You can record with the W-30 while it is synchronized to what is played by a MIDI sequencer connected to MIDI IN. Setup the connected external MIDI sequencer so that it sends clock information.

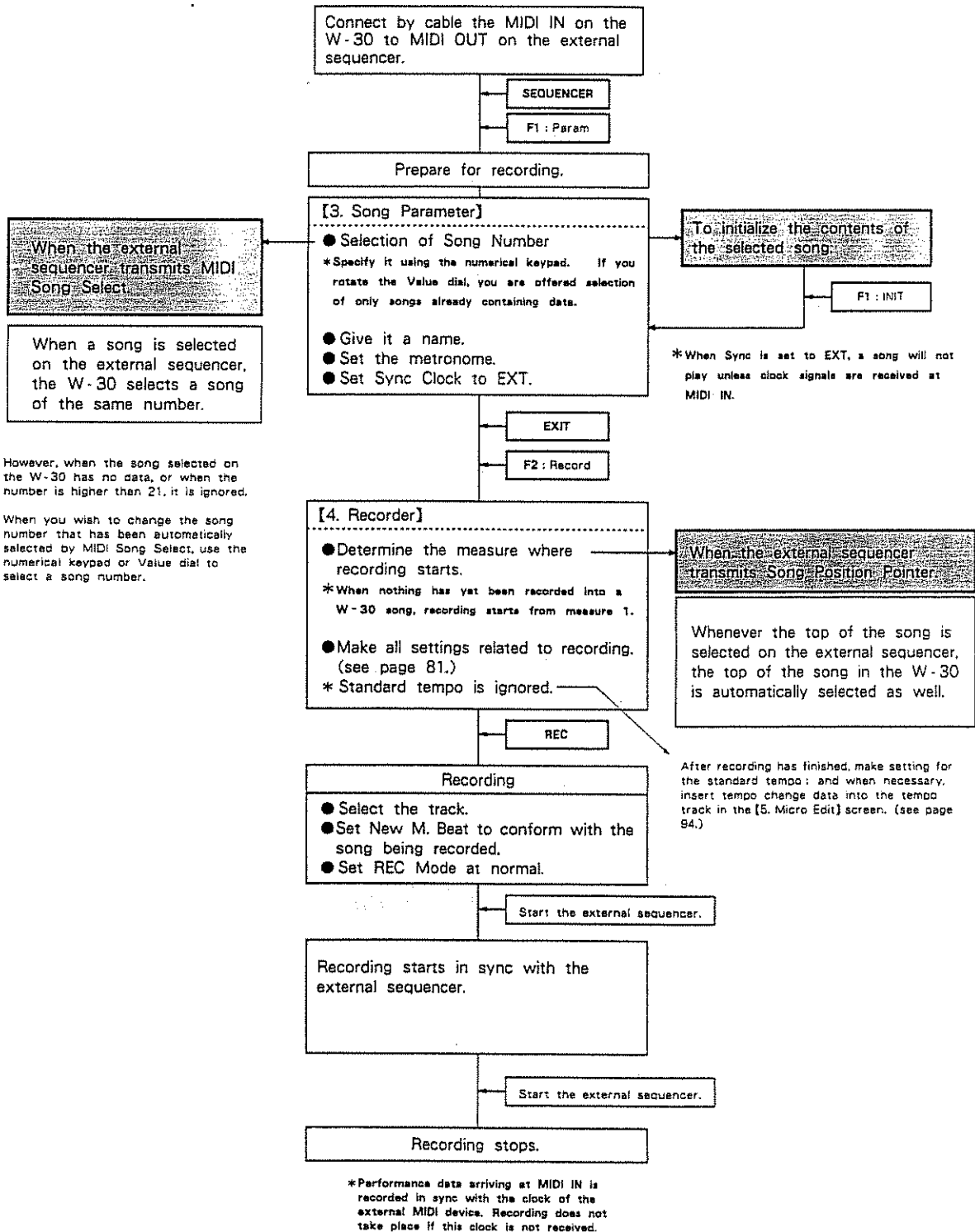

13. Other Functions

a. Saving System Configuration Data

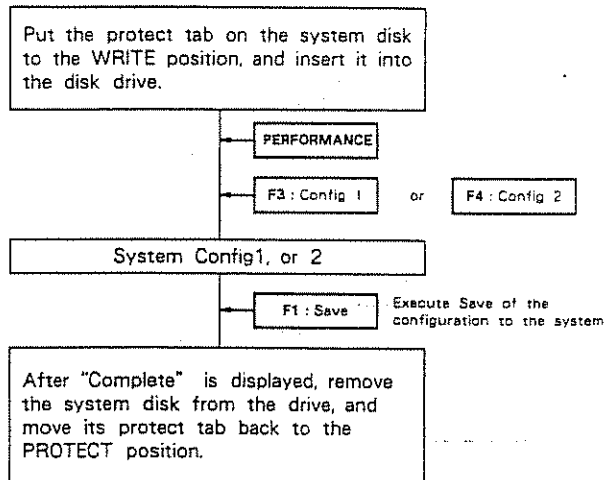

b. Formatting a Floppy Disk

A brand new disk or disks previously used for other hardware should be formatted for use with the W-30. Formatting, however, will erase any previous data on the disk.

* Disk Labels cannot be changed afterwards.

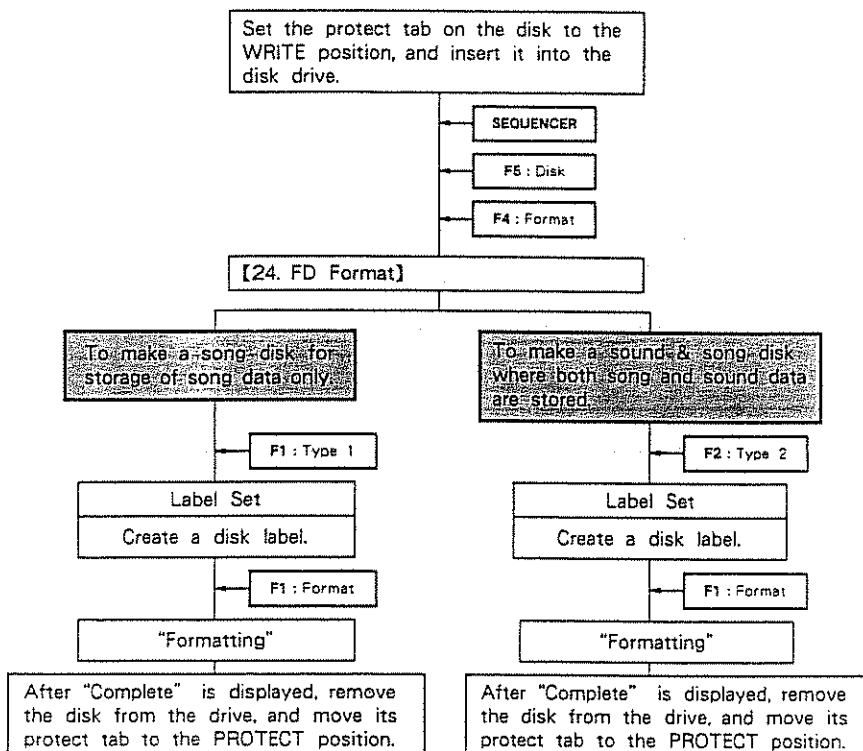

c. Copying a Floppy Disk

You can make a backup of W-30 disks as follows. This, however, will erase any data in the internal memory of the W-30. Therefore, you must save that data onto a disk beforehand, if necessary.

*Copies of the following types of disks can be made: S-50 (Ver.1,2), S-330, S-550, SYS-503, SYS-333, and SYS-553.

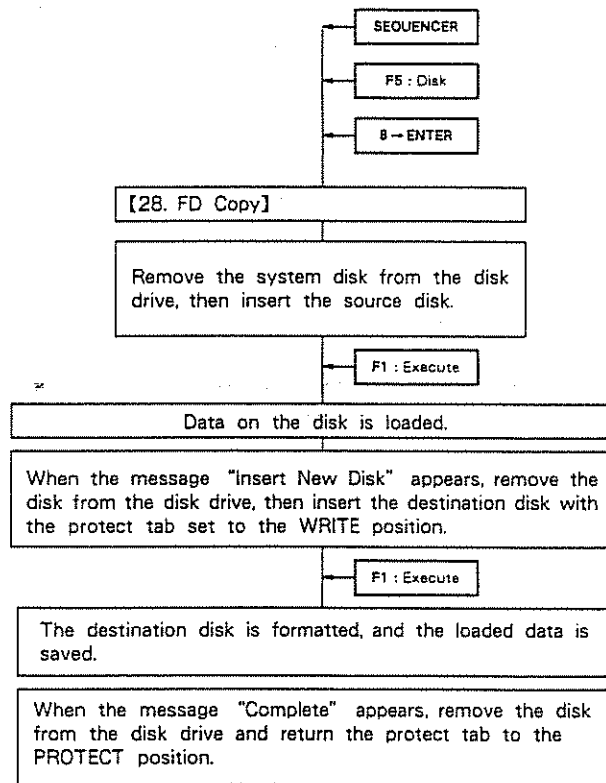



Chapter Five

Screen Functions

A screen by screen explanation of functions.

1. PERFORMANCE MODE

Parameters	Commands
<pre> I. Performance Patch P 1 Drums/Perc Level 127 P 1 Drums/Perc P 5 Fretless Bs1 P 2 Slap Bass 1 P 6 Fretless Bs2 P 3 Slap Bass 2 P 7 Fingered Bass P 4 Slap Bass 3 P 8 Syn Bass 1 M.Tune P.PRM Config1 Config2 --- </pre>	
<p>For playing the keyboard. Also for making settings respective to the W-30 system.</p>	
<p>Patch (Patch to be played on the keyboard) (Configuration Parameter) [P1]-[P16] Call the Patch you wish to play.</p>	
<p>Level (The volume of the sound played on the keyboard) (Configuration Parameter) [0]-[127] Adjust the volume of the Patch to be played.</p>	
<p>F1 M. Tune Master Tune (Master Tune) (FUNC Parameter) [-64]-[0]- Tunes the overall pitch of the W-30. At value 0, the W-30 [63] sounds in the same pitch as set with the Tone parameters.</p>	
<p>F2 P.PRM Octave Shift (Patch Octave Shift) (Patch Parameter) [-2]-[2] The sound range to be played on the keyboard can be shifted in units of an octave, above or below.</p>	
<p>Out Assign (Patch Output Socket) (Patch Parameter) This determines the output socket from which performance data played on the keyboard is transmitted. When () is indicated, the "Output Mode" is set to "Mix", therefore, the data is transmitted from the "1 (Mix)" socket regardless of the setting for Output Assign. [1]-[8] Patch performance data is output from the selected output socket. [F] Data is output separately for each Tone. The output socket for each Tone is set with the Tone parameter (page 154). In this case, however, the maximum number of playable voices is reduced, therefore some sounds may be left out.</p>	
<p>Bend Range (Patch Parameter) (Patch Parameter) [0]-[12] This sets the maximum pitch alteration caused by moving the bender/modulation lever to the right or left extremes. It is set in semitone steps, up to one octave.</p>	
<p>F3 Config1 KB Ch (Keyboard Channel) (Configuration Parameter) [1]-[16] This sets the MIDI transmit channel for the performance data played on the keyboard.</p>	<p>F1 Save This saves the data for the system configuration parameters onto the system disk (page 37,106).</p>

Parameters	Commands
<p>KB Oct (Keyboard Octave Shift) (Configuration Parameter) [-2]-[+2] At value 0, the keyboard sound range is C2 to C7. By changing values, the sound range can be shifted in units of an octave above or below.</p>	
<p>KB INT(MIDI Switch controlling path from the keyboard to the internal sound module) (Configuration Parameter) [On] / [Off] (Local On/Off) At On, performance data from the keyboard is sent to the internal sound module.</p>	
<p>KB EXT(MIDI Switch between the keyboard and MIDI OUT) (Configuration Parameter) [On] / [Off] At On, performance data from the keyboard is sent to MIDI OUT.</p>	
<p>MIDI INT(MIDI Switch between MIDI IN and the internal sound module) (Configuration Parameter) [On] / [Off] At On, performance data fed to MIDI IN is sent to the internal sound module.</p>	
<p>MIDI EXT (MIDI Switch between MIDI IN and MIDI OUT) (Configuration Parameter) [On] / [Off] (Soft Thru Switch) At On, performance data fed to MIDI IN is sent to MIDI OUT.</p>	
<p>TX Sync (Clock data transmission switch) (Configuration Parameter) [On] / [Off] At "On" clock, start, continue, stop, song position pointer, and song select data are transmitted from MIDI OUT.</p>	
<p>TX Sens (Active sensing transmission switch) (Configuration Parameter) [On] / [Off] At On, Active sensing data is sent from MIDI OUT.</p>	
<p>F4 Config2 This assigns a function to the optional pedal switch or expression pedal. Also, it sets the characteristics the sound will have upon reception of Breath Controller messages (MIDI Control Change No. 2).</p>	
<p>Modulation Depth (Modulation Depth) (Configuration Parameter) [0]-[127] Accepts setting for the value to be transmitted over MIDI when the modulation lever is pushed.</p>	
<p>Pedal SW [DP-2] (DP-2 Assignment) (Configuration Parameter) [Hold] This assigns the Hold (MIDI Control Change No. 64). While the pedal is pressed, the Note On state is maintained. [Start] This makes the pedal work just like the START/STOP button. [Punch] When pressed during recording of a song, it puts the unit into playback; and when pressed again, recording starts. Punch in or out can be accomplished with each press of the pedal. (It bears no relevance with the recording mode.)</p>	<p>F1 Save This saves the data for the system configuration parameters onto the system disk (page 37,106).</p>

[1. Performance]

























Parameters	Commands
<p>EXP Pedal [EV - 5] (EV-5 Assignment) <Configuration Parameter> [C.Chg #] Assigns MIDI Control Change messages Nos. 0 to 95.</p> <p>*The value output for the function varies depending on the angle the foot volume is pressed.</p> <p>*The following Control Change messages can be used for the W-30's sound module :</p> <ul style="list-style-type: none"> No.1 Modulation No.2 Breath Controller No.7 Volume No.64 Hold 1 <p>Breath Controller(Breath Controller Message Assignment) <Configuration Parameter></p> <p>This sets how the W-30's sound module should behave upon reception of Breath Controller messages. (MIDI Control Change No. 2)</p> <ul style="list-style-type: none"> [Off] No effect is obtained. [A.Touch] The same effect created by receiving Aftertouch messages is obtained. [Volume] The same effect caused by receiving Volume messages is obtained. [A.T & Vol] The same effect caused by receiving Aftertouch, and then Volume messages is obtained. 	

2. SEQUENCER MODE

Parameters	Commands
<pre> 3. Song Parameter] STOP Song 1 Metronome Off Accent CH 10 C#2 37 Vel 127 Normal CH 10 C#2 37 Vel 64 Sync Clock INT INIT --- --- Metro A Metro N </pre>	<p>F1 INIT</p> <p>This initializes the song currently selected, erasing all data contained there. (P.184)</p>
<p>Settings affecting the entire song are made here.</p> <p>[Song Number] Song Name (Song Parameter)</p> <p>[1]-[20] This selects a song, and allows naming of a song. Up to 28 characters can be used in a song name.</p> <p>*The Value Dial can be used to select only songs containing data. Enter the number of a song using the numerical keypad to select a song that has no data in it.</p>	<p>*The Standard Tempo and the parameters of the [32. Part Set] screen will not be initialized.</p>
<p>Metronome (Metronome) (Song Parameter)</p> <p>[Off] The metronome does not sound.</p> <p>[REC Only] The metronome sounds only when recording.</p> <p>[REC & Play] The metronome sounds during recording and playback.</p> <p>[Always] The metronome will always be heard (even when the unit is stopped).</p>	
<p>The W-30 does not have a specific metronome sound source, so it needs to play the W-30's sound module or an external sound module using MIDI Note ON messages. Select the sound to be used for the metronome with Channel and Note Numbers, and set the volume with Velocity.</p> <p>Accent This sets the sound for the first beat.</p> <p>Normal This sets the sound for the other beats.</p>	<p>F4 Metro A</p> <p>The sound for the accent is played.</p> <p>F5 Metro N</p> <p>The sound for other (normal) beats is played.</p>
<pre> Metronome Accent Ch 10 C#2 37 Vel 127 Normal Ch 10 C#2 37 Vel 64 </pre> <p style="text-align: center;"> ↑ ↑ ↑ </p> <p style="text-align: center;"> MIDI Channel Note Number Velocity </p>	
<p>MIDI Channel</p> <p>[1]-[16] Transmitted to the W-30's internal sound module. Not transmitted from MIDI OUT.</p> <p>[E1]-[E16] Transmitted from MIDI OUT at all times. Not transmitted to the internal sound module.</p>	
<p>Sync Clock (MIDI Sync Clock) (Song Parameter)</p> <p>[INT] In this mode, the W-30 plays (records) at the set standard tempo.</p> <p>[EXT] In this mode, the W-30 plays (records) while synchronized to clock signals received from MIDI IN. The start/stop of the unit can also be controlled from the external MIDI device.</p> <p>*Receives clock, start, continue, stop, song position pointer, and song select.</p>	

Parameters	Commands
<div data-bbox="156 336 949 563" style="border: 1px solid black; padding: 5px;"> <p>4. Recorder STOP</p> <p>Song 1</p> <p>M= 1 o----- *Internal*</p> <p>J= 120 [----] [ABCDEFGH]</p> <p>Track status ----- 98%</p> <p>REC PRM REC SW TRK PRM KB PRM Locate</p> </div> <p>Governs song recording.</p> <p>[Song Number] Song Name</p> <p>[1]-[20] This selects a song.</p> <p>*The Value Dial can be used to select only songs containing data. Enter the number of a song using the numerical keypad to select a song that has no data in it.</p> <p>M =</p> <p>Indicates the current position (measure). When in the middle of a measure, "+" is displayed. Starts from the point where recording is to start.</p> <p>[1] - If you are recording for the first time, [1] is automatically set.</p> <p>*Pressing ◀ ▶ will increase or decrease the measure number.</p> <p>Pressing H provides return to the first measure.</p> <p>Pressing H moves you to the last measure.</p> <p>J = []</p> <p>[10]-[250] This sets the standard tempo.</p> <p>The number in [] represents the new tempo when the tempo has been altered with the Tempo Change message in the course of a song.</p> <p>*The standard tempo can also be set by rotating the Value Dial while holding TEMPO down.</p> <div data-bbox="173 1457 966 1681" style="border: 1px solid black; padding: 5px;"> <p style="text-align: center;">Represents each Part; inverted when Note messages are received.</p> <p style="text-align: center;">↓</p> <p style="text-align: center;">[ABCDEFGH]</p> <p style="text-align: center;">↓</p> <p style="text-align: center;">Track 15</p> <p style="text-align: center;">↑</p> <p style="text-align: center;">This shows the remaining capacity of internal memory for song data. When 0% is indicated, no more data can be recorded.</p> <p style="text-align: center;">↑</p> <p style="text-align: center;">98%</p> <p style="text-align: center;">↑</p> <p style="text-align: center;">Track status PR-M-----</p> <p style="text-align: center;">↑</p> <p style="text-align: center;">P indicates tracks played; M, tracks muted; and R, tracks being recorded.</p> <p style="text-align: center;">↑</p> <p style="text-align: center;">Track 1</p> <p style="text-align: center;">↓</p> <p style="text-align: center;">Track 2</p> <p style="text-align: center;">↓</p> <p style="text-align: center;">Track 3 ...</p> </div> <p>REC Recording.....</p> <p>This is the parameter to be set before recording.</p> <p>Track (Recording Track) (Song Parameter)</p> <p>[1]-[16] This selects the track to be used for recording.</p>	<div data-bbox="1015 1719 1214 1755" style="border: 1px solid black; padding: 2px; text-align: center;"> <p>START/STOP</p> </div> <p>Pressing this button will start recording, and pressing it again will stop recording.</p>

Parameters	Commands
<p>New M. Beat (Beat for new measures to be recorded) (Song Parameter) $[1/2]-[32/2], [1/4]-[32/4], [1/8]-[32/8]$ and $[1/16]-[32/16]$ This sets the Beat for measures where data is not yet recorded.</p>	
<p>REC Mode (Recording Mode) This selects one of the following seven recording modes.</p>	
<p>[Normal] With REC pressed and the sub-window open, recording begins when you press START/STOP. Press START/STOP again to stop recording.</p>	
<p>[Key On] With REC pressed and the sub-window open, recording starts from the moment you play the keyboard. (The same effect as pressing START/STOP under Normal Recording.) Also, with REC pressed and the sub-window open, if you press START/STOP it enters the play condition, and after that when you play the keyboard (reception of note messages starts) recording automatically starts from that moment. Press START/STOP again to stop recording.</p>	
<p>[Punch I.O] (Auto Punch IN/OUT) The region to be re-recorded is specified beforehand in terms of a REC Start Point (0) and REC End Point (9). After pressing REC, thus opening the sub-window, START/STOP is pressed to enter the play condition. Thereafter, when the REC Start Point is reached, recording starts. When the REC End Point is reached, it returns to the play condition. Pressing START/STOP will stop it.</p>	
<p>[Punch IN] (Auto Punch IN) The point where recording is to start is specified beforehand with REC Start Point (0). Press REC and the sub-window will open. Then, when START/STOP is pressed it enters the play condition. When the REC Start Point is reached, it goes into record. When START/STOP is pressed again, it stops.</p>	
<p>[Punch OUT] (Auto Punch OUT) The point where recording is to finish is specified beforehand with REC End Point (9). Press REC and the sub-window will open. Then, when START/STOP is pressed it starts recording. Thereafter, when the REC End Point is reached it enters the play condition. When START/STOP is pressed again, it stops.</p>	
<p>[Punch MAN] (Manual Punch IN/OUT) With REC pressed and the sub-window open, it enters the play condition when you then press START/STOP. Thereafter, recording starts the moment you press REC. When you press REC again, it returns to the play condition. When START/STOP is pressed, it stops.</p>	
<p>[Loop] The region to be re-recorded is specified beforehand by means of REC Start Point (0) and REC End Point (9). Then, after pressing REC and opening the sub-window, press START/STOP. It will jump to the REC Start Point and start recording. When the REC End Point is reached, it returns to the REC Start Point and continues recording. When START/STOP is pressed it stops.</p>	

Parameters	Commands								
<p>*Pressing REC is equivalent to depressing a DP-2 which has manual punch in/out (Punch) assigned to it.</p> <p>*Pressing START/STOP is equivalent to depressing a DP-2 which has Start/Stop (Start) assigned to it.</p> <p>*With Loop recording, allow more than one measure between the REC Start Point and REC End Point.</p> <p>*During Loop recording, it records alongside existing data on the track, so no data in the recording track is erased. In other recording modes, the existing data on the track is erased.</p>									
<p>F1 REC PRM</p>									
<p>This function sets the parameters relative to recording.</p>									
<p>Quantize (Recording Quantization)</p>									
<p>Real time recording uses a resolution equivalent to 1/96 of a quarter note (when [OFF]). Quantize automatically corrects slight timing inaccuracies occurring when recording real-time performances. In other words, it forces the note positions to align at intervals that accord with the base resolution. You can select one of the following quantization resolutions in the W-30.</p>									
<table border="0"> <tr> <td>[1/2] ...  Half note</td> <td>[1/16] ...  Sixteenth note</td> </tr> <tr> <td>[1/4] ...  Quarter note</td> <td>[1/24] ...  Sixteenth-note triplets</td> </tr> <tr> <td>[1/8] ...  Eighth note</td> <td>[1/32] ...  Thirty-second note</td> </tr> <tr> <td>[1/12] ...  Eighth-note triplets</td> <td>[1/64] ...  Sixty-fourth note</td> </tr> </table>	[1/2] ...  Half note	[1/16] ...  Sixteenth note	[1/4] ...  Quarter note	[1/24] ...  Sixteenth-note triplets	[1/8] ...  Eighth note	[1/32] ...  Thirty-second note	[1/12] ...  Eighth-note triplets	[1/64] ...  Sixty-fourth note	
[1/2] ...  Half note	[1/16] ...  Sixteenth note								
[1/4] ...  Quarter note	[1/24] ...  Sixteenth-note triplets								
[1/8] ...  Eighth note	[1/32] ...  Thirty-second note								
[1/12] ...  Eighth-note triplets	[1/64] ...  Sixty-fourth note								
<p>Offset (Recording Quantize Offset)</p>									
<p>[-100]-[100] Offset can shift the timing of quantization forward or backward and record it to create a forward or backward oriented beat. The base unit for the offset is 1 clock (1/96 of a quarter note). "-" values locate it before the beat, while "+" values place it after the beat.</p> <p>* When Quantize = Off, this parameter has no effect.</p>									
<p>Gate Time (Recording Gate Time)</p>									
<p>[Real] This is a special value in which the W-30 records each note exactly as it is played.</p>									
<p>[1]-[9999] The W-30 allows you to set the time between Key On to Key Off (the gate time). The base unit for the gate time is one clock (1/96 of a quarter note). For instance, a value of 96 makes every note a quarter note no matter how long you are pressing the key.</p>									

Parameters	Commands
<p>F2 REC SW <small>various (Song Parameter)</small> You can select MIDI events to be recorded. At On, the event will be recorded, and at Off, it will not be recorded.</p> <ul style="list-style-type: none"> PAf : Polyphonic Aftertouch C.Chg : Control Change P.Chg : Program Change CAf : Channel Aftertouch Bend : Pitch Bender Excl : Exclusive and Tune Request messages <p>* Note messages are always recorded.</p> <p>F3 TRK PRM (Track Parameter) This sets track name, Play/Mute status, and MIDI Switch.</p> <p>[Track Number] Track Name (Track Parameter) [1]-[16] This selects a track. A track can be named using up to 8 characters.</p> <p>Play/Mute (Track Mode) (Track Parameter)</p> <ul style="list-style-type: none"> [Mute] All events except Note event ones are output. [Play] All events are output. <p>I (MIDI Switch between track and internal sound module) (Track Parameter) [On] / [Off] [On] transmits track's performance information to internal sound module.</p> <p>E (MIDI Switch between track and MIDI OUT) (Track Parameter)</p> <ul style="list-style-type: none"> [On] / [Off] "On" transmits track's performance information to MIDI OUT. 	<p>F3 Mode Toggles between the Mute and Play modes.</p> <p>F4 INT Toggles between On and Off states.</p> <p>F5 EXT Toggles between On and Off states.</p>
<p>F4 KB PRM (Keyboard Parameter)</p> <p>Ch (Keyboard Channel) (Configuration Parameter) [1]-[16] This sets the MIDI transmit channel for performance data played on the keyboard. If you play the keyboard while recording, the performance is recorded as being for the channel set here.</p> <p>Octave (Keyboard Octave Shift) (Configuration Parameter) [-2]-[+2] At value [0], the sound range from C2 to C7 on the keyboard can be played. By changing values, the sound range can be shifted above or below in one octave units.</p> <p>P (Program Change number that the keyboard transmits)</p> <ul style="list-style-type: none"> [1]-[128] The Program Change number selected here will be transmitted on the set keyboard channel by pressing the F1 button. <p>I (MIDI Switch between keyboard and internal sound module) (Configuration Parameter)</p> <ul style="list-style-type: none"> [On] / [Off] (Local On/Off) "On" will transmit the keyboard's performance data to the internal sound module. 	<p>F1 PG Send This button sends the Program Change number you have selected.</p> <p>F4 INT Toggles between On and Off.</p>

Parameters	Commands
<p>E (MIDI Switch between keyboard and MIDI OUT) (Configuration Parameter)..... [On] / [Off] "On" will transmit the keyboard's performance data from MIDI OUT.</p> <p>F5 Locate (Locate Point) This allows you to set a locate point. Locate points are REC Start Point, REC End Point and eight user's points.</p> <p>0 (REC Start Point) (Song Parameter) This sets the starting point for Loop recording or Auto Punch In recording.</p> <p>9 (REC End Point) (Song Parameter) This sets the ending point for Loop recording or Auto Punch Out recording.</p> <p>*In Loop recording, make the distance between the REC Start and REC End points longer than one measure. If set to shorter than one measure, the W-30 displays the message "Point Error" and cannot perform the Loop recording. (It reverts to Normal.)</p> <p>1 - 8 (User's Points) (Song Parameter) You can set certain locate points to which you may jump later.</p>	<p>F5 EXT Toggles between On and Off.</p> <p>F1 Jump Pressing this button with the song stopped jumps you to the locate point you have set.</p> <p>F2 Set The current position is set as the Locate Point (page-90).</p>

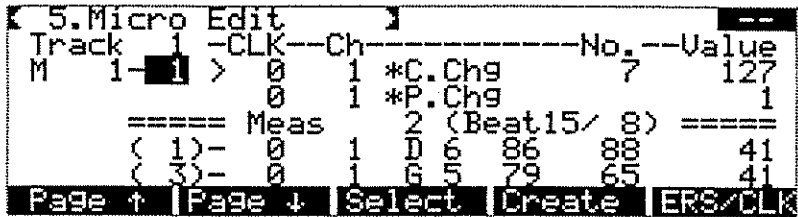

This allows you to perform detailed editing on individual MIDI events. Position the event you wish to edit at the uppermost line on the display, then move the cursor to the value to edit it.

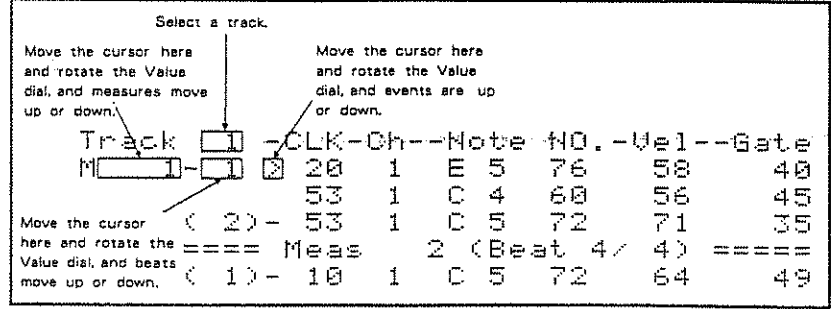

F1 **F2**
 Using these buttons, you can go up or down, one event at a time.

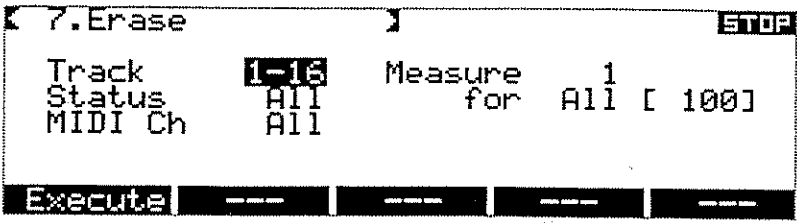
Parameters	Commands
<p>Editing and Creating Exclusive Data</p>	
<p>● Editing Exclusive Data</p> <p>Move the cursor to the right (manufacturers ID) and a sub-window opens. This is the screen for editing Exclusive data. (A maximum of 500 bytes of data can be edited.)</p> <p>● Creating Exclusive Data</p> <p>After pressing F4, and creating Exclusive data by means of Status = [EX], a sub-window opens; this allows editing of Exclusive data. (Up to 500 bytes of Exclusive data can be created.)</p> <p>(F0) represents the start of Exclusive and (F7) represents the end. The value shown after (F0) is the manufacturer's ID.</p>	<p>F4 Insert This will insert 00 at the cursor position.</p> <p>F5 Delete This will delete data at the cursor position.</p> <p>F3 C.Sum Calculates the checksum (page 195.)</p> <p>F1 Ok Press this when editing has been completed.</p>
<p>F5 ERS/CLK</p> <ul style="list-style-type: none"> ● This will erase the event on the top line. ● This will move the event (Change Clock) of the top line. * The event cannot be moved to another track. * If you fail to select the event to be edited in the Micro Editing display, the sub-window will not open. <p>Destination Location</p> <p>This allows you to specify the location to which the event is moved in terms of M (Measure) - (Beat) - (Clock).</p>	<p>F1 Erase Erases the selected event.</p> <p>F2 CHG CLK Changes the clock of (moves) the selected event.</p>
 <p>This erases events in a track.</p> <p>Track (Track to be edited) [1]-[16], Select a track to be erased. [1-16] [T]</p>	<p>F1 Execute Press this button to execute Erase.</p> <p>*When you have selected [Note], [PAf], [C.Chg] or [P.Chg], specify the range to be erased.</p> <p>*The value of "Note # Range" for [Note] and [PAf] can be entered from the keyboard as well.</p>

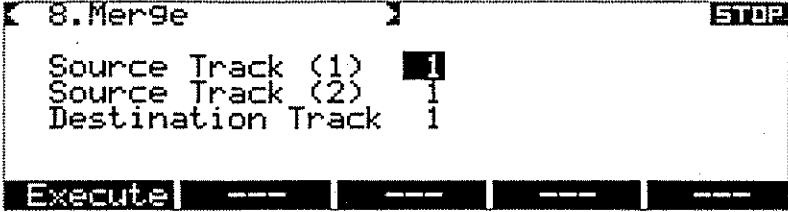
Parameters	Commands
<p>Status (Specifying the MIDI Status) [All], [Note], [PAf], [C.Chg], [P.Chg], [CAf], [Bend], [EX], [TU] and [Tempo (Only when T is selected under Track)] This allows you to erase only the MIDI status you have specified.</p> <p>MIDI Ch (Specifying the MIDI Channel) [1]-[16], Only the specified MIDI channel's data is erased. [All]</p> <p>Measure (Specifying the measure) This allows you to erase only data within a specified region. Set the range with [Measure] (from which measure) and [for] (for how many measures). [All] will erase all the way to the last measure.</p>	
 <p>Two phrase tracks can be merged and written into a different phrase track. This will empty the two tracks which previously contained song data.</p> <p>*If you merge two tracks on the same MIDI channel, the merged data can no longer be extracted as two separate tracks afterwards.</p> <p>Source Track (1) (The first Source Track to be merged) [1]-[16] Specify one source track to be merged.</p> <p>Source Track (2) (The second Source Track to be merged) [1]-[16] Specify another source track to be merged. The same track as Source Track (1) cannot be selected.</p> <p>Destination Track (The Track where the merged data is written) [1]-[16] Specify the track where the merged data of the two tracks is to be written. *When Merge is executed, any previous data in the destination track will be erased.</p>	<p>F1 Execute Press this button to execute Merge.</p>



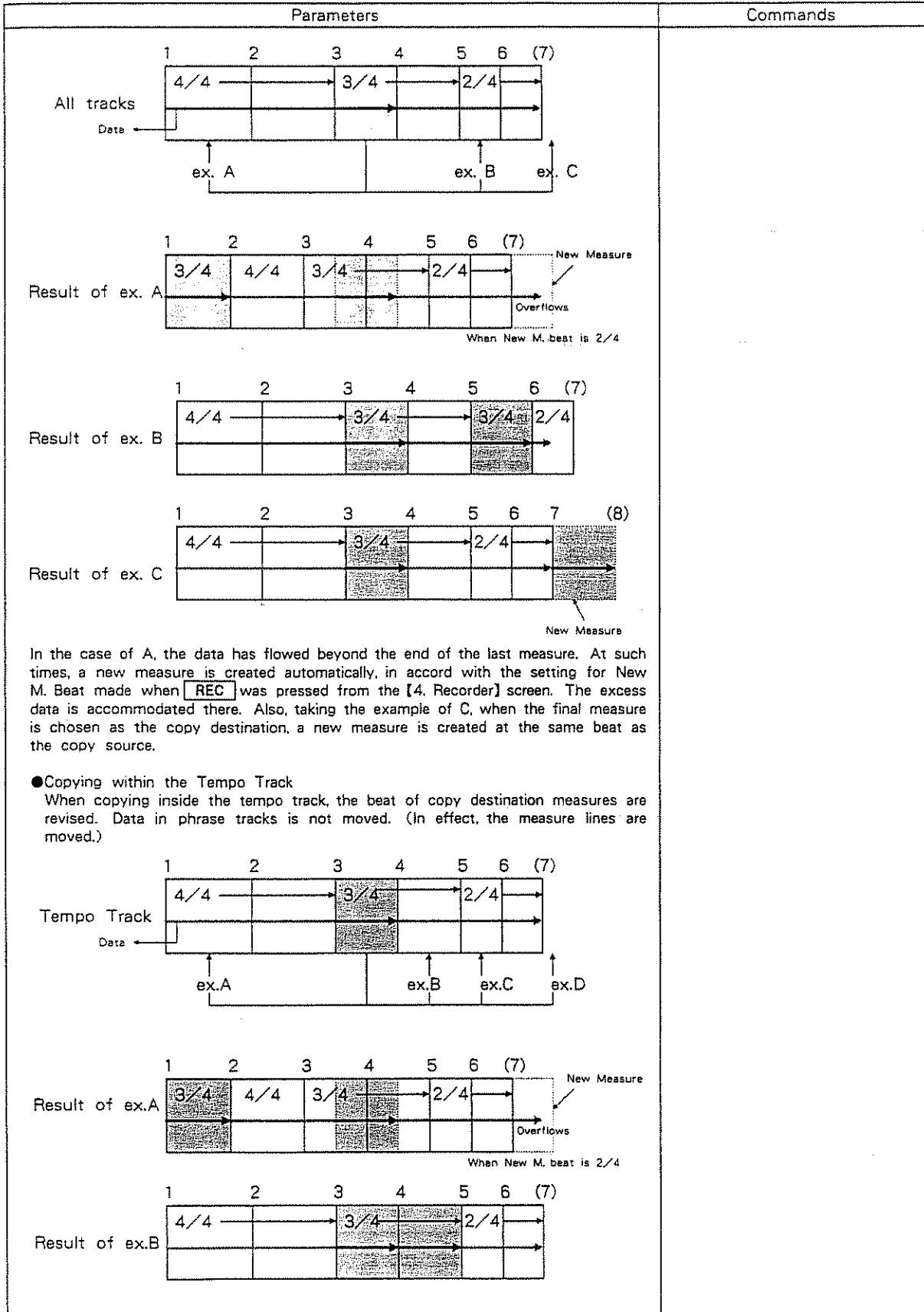





















Parameters	Commands																												
<div style="border: 1px solid black; padding: 5px; margin-bottom: 10px;"> <div style="display: flex; justify-content: space-between; border-bottom: 1px solid black;"> 9. COPY STOP </div> <div style="margin-top: 5px;"> <table style="width: 100%; border-collapse: collapse;"> <tr> <td style="width: 20%;">Track</td> <td style="width: 15%;">All</td> <td style="width: 20%;">Measure</td> <td style="width: 10%;">1</td> <td style="width: 35%;"></td> </tr> <tr> <td>Status</td> <td>All</td> <td>for</td> <td>All</td> <td>[100]</td> </tr> <tr> <td>MIDI Ch</td> <td>All</td> <td>Dest. Track</td> <td>All</td> <td></td> </tr> <tr> <td>Copy Times</td> <td>1</td> <td>Measure</td> <td>END</td> <td></td> </tr> </table> </div> <div style="border-top: 1px solid black; padding-top: 5px;"> Execute </div> </div> <p>This allows you to copy any event in a track to any location you like.</p> <ul style="list-style-type: none"> *The copy function cannot be used between a phrase track and the tempo track. *When the measure data of the copy source is copied, existing data, of an amount equivalent to the amount copied, is erased at the copy destination. <p>● Copying between phrase tracks.</p> <p>When copying between phrase tracks, the beat of the measures at the copy destination does not change.</p> <div style="margin-top: 10px;"> <p style="text-align: center;">Result of ex.A Result of ex.B Result of ex.C Result of ex.D</p> <p style="text-align: center;">When New M. Beat is 2/4</p> </div> <p>In copy B, no problem is presented since copy takes place between measures having the same beat. However, with A and C, where copy is between measures having different beats, at times measures may not be copied completely, or they may overlap into the next measure.</p> <p>Also, when the final measure is chosen as the copy destination, as in ex. D, a new measure is created in accord with the setting for New M. Beat made when REC was pressed from the [4. Recorder] screen. Thus, copy is successful.</p> <ul style="list-style-type: none"> ● To copy to all tracks. (All) <p>Copy All copies specific measures in a song to other measures. The copy source and copy destination must both be set to "All" or it cannot be executed.</p> <div style="margin-top: 10px;"> <table style="width: 100%; border-collapse: collapse;"> <tr> <td style="width: 15%;">Phrase Track 1</td> <td style="width: 85%; border: 1px solid black; text-align: center;"> <div style="display: flex; justify-content: space-between; border-bottom: 1px solid black;"> </div> <div style="display: flex; justify-content: center; align-items: center;"> <div style="width: 20%;"></div> <div style="width: 20%; background-color: gray; border: 1px solid black;"></div> <div style="width: 20%;"></div> <div style="width: 20%;"></div> </div> </td> </tr> <tr> <td>Phrase Track 2</td> <td style="border: 1px solid black; text-align: center;"> <div style="display: flex; justify-content: space-between; border-bottom: 1px solid black;"> </div> <div style="display: flex; justify-content: center; align-items: center;"> <div style="width: 20%;"></div> <div style="width: 20%; background-color: gray; border: 1px solid black;"></div> <div style="width: 20%;"></div> <div style="width: 20%;"></div> </div> </td> </tr> <tr> <td style="text-align: center;">⋮</td> <td></td> </tr> <tr> <td>Tempo Track</td> <td style="border: 1px solid black; text-align: center;"> <div style="display: flex; justify-content: space-between; border-bottom: 1px solid black;"> </div> <div style="display: flex; justify-content: center; align-items: center;"> <div style="width: 20%;"></div> <div style="width: 20%; background-color: gray; border: 1px solid black;"></div> <div style="width: 20%;"></div> <div style="width: 20%;"></div> </div> </td> </tr> </table> </div>	Track	All	Measure	1		Status	All	for	All	[100]	MIDI Ch	All	Dest. Track	All		Copy Times	1	Measure	END		Phrase Track 1	<div style="display: flex; justify-content: space-between; border-bottom: 1px solid black;"> </div> <div style="display: flex; justify-content: center; align-items: center;"> <div style="width: 20%;"></div> <div style="width: 20%; background-color: gray; border: 1px solid black;"></div> <div style="width: 20%;"></div> <div style="width: 20%;"></div> </div>	Phrase Track 2	<div style="display: flex; justify-content: space-between; border-bottom: 1px solid black;"> </div> <div style="display: flex; justify-content: center; align-items: center;"> <div style="width: 20%;"></div> <div style="width: 20%; background-color: gray; border: 1px solid black;"></div> <div style="width: 20%;"></div> <div style="width: 20%;"></div> </div>	⋮		Tempo Track	<div style="display: flex; justify-content: space-between; border-bottom: 1px solid black;"> </div> <div style="display: flex; justify-content: center; align-items: center;"> <div style="width: 20%;"></div> <div style="width: 20%; background-color: gray; border: 1px solid black;"></div> <div style="width: 20%;"></div> <div style="width: 20%;"></div> </div>	<div style="border: 1px solid black; padding: 5px; margin-bottom: 10px;"> <div style="display: flex; justify-content: space-between; border-bottom: 1px solid black;"> F1 Execute </div> <p>Press this button to execute Copy.</p> <ul style="list-style-type: none"> *When you have selected [Note], [PAf], [C.Chg] or [P.Chg], specify the range to be copied. *The value of "Note # Range" for [Note] and [PAf] can be entered from the keyboard as well. </div>
Track	All	Measure	1																										
Status	All	for	All	[100]																									
MIDI Ch	All	Dest. Track	All																										
Copy Times	1	Measure	END																										
Phrase Track 1	<div style="display: flex; justify-content: space-between; border-bottom: 1px solid black;"> </div> <div style="display: flex; justify-content: center; align-items: center;"> <div style="width: 20%;"></div> <div style="width: 20%; background-color: gray; border: 1px solid black;"></div> <div style="width: 20%;"></div> <div style="width: 20%;"></div> </div>																												
Phrase Track 2	<div style="display: flex; justify-content: space-between; border-bottom: 1px solid black;"> </div> <div style="display: flex; justify-content: center; align-items: center;"> <div style="width: 20%;"></div> <div style="width: 20%; background-color: gray; border: 1px solid black;"></div> <div style="width: 20%;"></div> <div style="width: 20%;"></div> </div>																												
⋮																													
Tempo Track	<div style="display: flex; justify-content: space-between; border-bottom: 1px solid black;"> </div> <div style="display: flex; justify-content: center; align-items: center;"> <div style="width: 20%;"></div> <div style="width: 20%; background-color: gray; border: 1px solid black;"></div> <div style="width: 20%;"></div> <div style="width: 20%;"></div> </div>																												



Parameters	Commands
<div style="text-align: center;"> <p>1 2 3 4 5 6 (7)</p> <p>Result of ex.C</p> </div> <div style="text-align: center;"> <p>1 2 3 4 5 6 7 (8)</p> <p>Result of ex.D</p> <p style="text-align: right;">New measure</p> </div>	
<p>B presents no problems, but with copy A or C, the beat changes, so the measure lines move.</p> <p>In A the data extends beyond the last measure. In this case, a new measure is created automatically, in accord with the setting for New M. Beat made when REC was pressed from the [4. Recorder] screen. The excess data is accommodated there. Also, in the example of D, when the final measure is chosen as the copy destination, a new measure is created at the same beat as the copy source.</p>	
<p>Track (Source Track) [1]-[16], Select the track to be copied. [T] [All]</p>	
<p>Status (Specifying the MIDI Status to be copied) [All],[Note],[PAf],[C.Chg],[P.Chg],[CAf],[Bend],[EX],[TU] and [Tempo (Only when T is selected under Track)] This allows you to copy only the MIDI status you have specified.</p>	
<p>MIDI Ch (Specifying the MIDI Channel) [1]-[16], Only the specified MIDI channel's data is copied. [All]</p>	
<p>Copy Times (Number of times to be copied) [1]-[99] Set how many times to be copied.</p>	
<p>Measure (Specifying the measure) This allows you to copy data respective only to a specified range. Set the range with [Measure] (from which measure) and [for] (for how many measures). [All] will copy up to the last measure.</p>	
<p>Dest. Track (Destination Track) [1]-[16] Specify the new location for the copied data. [T] [All]</p>	
<p>Measure (Destination Measure) Specify the measure number in the track receiving the copied data. ([END] is the last measure of the selected song.)</p>	

Parameters	Commands
<div style="border: 1px solid black; padding: 5px; margin-bottom: 10px;"> <p style="text-align: center;">10. Quantize STOP</p> <p>Track 1 Measure 1</p> <p>MIDI Ch All for All [100]</p> <p>Quantize 1/64 Mode Note On</p> <p>Offset 0 -> Track 1</p> <p style="background-color: black; color: white; padding: 2px;">Execute --- --- --- ---</p> </div> <p>This function automatically corrects slight timing inaccuracies recorded in a real-time performance, by aligning (quantizing) note On and Off and durations to a specified resolution, on individual or multiple measures. The corrected data can be written into any phrase track.</p> <ul style="list-style-type: none"> *Any previous data stored in the destination track for the quantized data will be erased. *Quantized song data cannot be reverted to its previous form. ● When quantized data extends beyond the final measure. <div style="margin-bottom: 10px;"> </div> <div style="margin-bottom: 10px;"> </div> <p>When data has extended beyond the final measure, a new measure is created automatically, in accord with the setting for New M. Beat made when REC was pressed from the [4. Recorder] screen. The excess data is accommodated there.</p> <ul style="list-style-type: none"> ● When quantized data comes before the start of the first measure (due to an offset) <div style="margin-bottom: 10px;"> </div> <div style="margin-bottom: 10px;"> <p style="margin-left: 40px;">Shift</p> </div> <p>It is fixed at the top of the first beat in the first measure (M/B/C = 1/1/0)</p>	<p>F1 Execute</p> <p>This will execute Quantization.</p> <ul style="list-style-type: none"> *Set the range of [Note] to be quantized. *The value of "Note # Range" can be entered from the keyboard as well.

[11. Delete Measure]

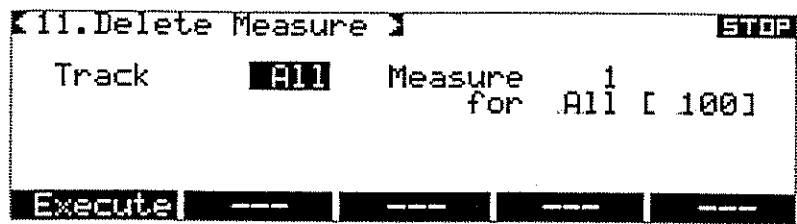
Parameters	Commands								
<p>Track (Track to be edited) [1]-[16] Specify the track to be edited.</p> <p>MIDI Ch (Specifying the MIDI Channel) [1]-[16]. Data on only a specified MIDI channel can be edited. [All]</p> <p>Quantize (Quantize Resolution) Select the resolution for the quantization.</p> <table border="0" data-bbox="247 595 875 893"> <tr> <td>[1/2] ...  Half note</td> <td>[1/16] ...  Sixteenth note</td> </tr> <tr> <td>[1/4] ...  Quarter note</td> <td>[1/24] ...  Sixteenth-note triplets</td> </tr> <tr> <td>[1/8] ...  Eighth note</td> <td>[1/32] ...  Thirty-second note</td> </tr> <tr> <td>[1/12] ...  Eighth-note triplets</td> <td>[1/64] ...  Sixty-fourth note</td> </tr> </table> <p>Offset (Quantize Offset) [-100] - [100] Offset can shift the timing of quantized events forward or backward in 1 clock units (1/96 of a quarter note). * For details see page 85.</p> <p>Measure (Specifying the range for quantization) Quantization can be performed on individual or multiple measures. Specify [Measure] (from which measure) and [for] (for how many measures). [All] will quantize up to the last measure.</p> <p>Mode (Quantize Mode) This selects which timing should be quantized. [Note On] The timing of Note On is corrected. [Note Off] The timing of Note Off is corrected. [Gate] The gate time (duration) is corrected.</p> <p>→ Track (Destination track) [1]-[16] Specify the track where the quantized data is to be written.</p>	[1/2] ...  Half note	[1/16] ...  Sixteenth note	[1/4] ...  Quarter note	[1/24] ...  Sixteenth-note triplets	[1/8] ...  Eighth note	[1/32] ...  Thirty-second note	[1/12] ...  Eighth-note triplets	[1/64] ...  Sixty-fourth note	
[1/2] ...  Half note	[1/16] ...  Sixteenth note								
[1/4] ...  Quarter note	[1/24] ...  Sixteenth-note triplets								
[1/8] ...  Eighth note	[1/32] ...  Thirty-second note								
[1/12] ...  Eighth-note triplets	[1/64] ...  Sixty-fourth note								
 <p>Allows you to delete events from a track by measure. Data coming afterwards then occurs earlier, filling the space created as a result of the delete.</p>									

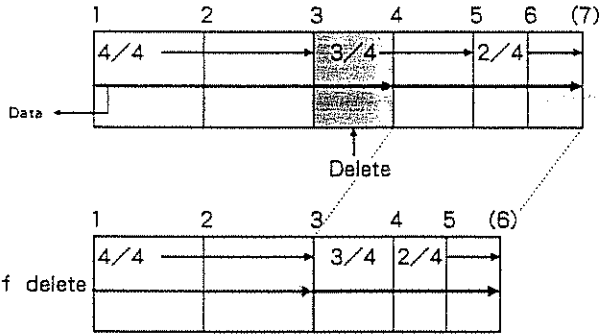
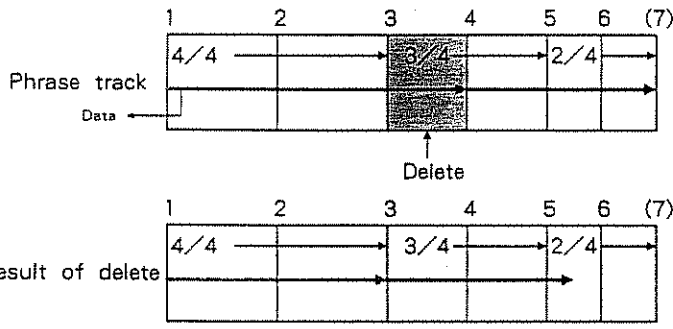
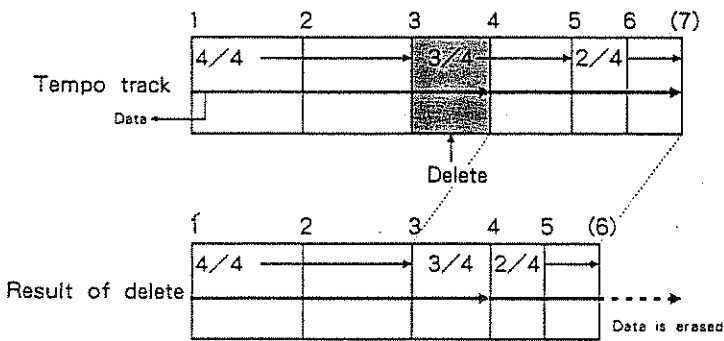
Parameters	Commands
<p>Track (Track to be edited) [1] [16]. Specify the track to be deleted. [T] [All]</p> <p>Measure (Specifying the range to be deleted) Deleting can be performed on individual or multiple measures. Specify [Measure] (from which measure) and [for] (for how many measures). [All] will delete down to the last measure.</p> <ul style="list-style-type: none"> ●Deleting measures for all tracks (All) The measures and the data contained in them is deleted.  <ul style="list-style-type: none"> ●Deleting measures from phrase tracks The data within the measures is deleted, and any data coming afterward is shifted forward. The beat of the measures does not change.  <ul style="list-style-type: none"> ●Deleting measures from the tempo track The measures are erased. Data in the phrase track does not shift. (Consider the measure lines as moving.) Any data extending beyond the final measure is erased. 	<p>F1 Execute Executes the Delete.</p>

[12. Insert Measure]

Parameters	Commands
<div style="border: 1px solid black; padding: 5px; margin-bottom: 10px;"> <p>[12. Insert Measure] STOP</p> <p>Track All Measure 1</p> <p>Beat 4/4 Count 1</p> <p>Execute --- --- --- ---</p> </div> <p>This allows you to insert blank measures into any or all tracks. Any following data is moved so it occurs afterwards in the track.</p> <p>Track (Track to be edited)</p> <p>[1]-[16]. Specify the track where blank measures are to be inserted.</p> <p>[T] [All]</p> <p>Beat (Beat of the blank measures)</p> <p>[1/2]-[32/2],[1/4]-[32/4],[1/8]-[32/8] and [1/16]-[32/16]</p> <p>Select the Beat of the measures to be inserted.</p> <p>Measure (Position of insertion)</p> <p>[1] - Insertion takes place at this measure, and any following measures are shifted towards the end.</p> <p>Count (Number of measures to be inserted)</p> <p>[1] - Specify how many measures are to be inserted.</p> <p style="text-align: center;">*A song can not exceed 9,998 measures.(9,999th becomes an Ending Measure)</p> <p>●Inserting measures in a phrase track</p> <p>Data will shift towards the end only for the amount of measures specified. The beat of measures does not change.</p> <div style="margin-top: 20px;"> </div> <p>Since data will overflow, extending beyond the final measure, a new measure is created automatically, in accord with the setting for New M. Beat made when REC was pressed from the [4. Recorder] screen. The excess data is accommodated there.</p>	<p>F1 Execute</p> <p>This will execute the Insert Measure.</p>

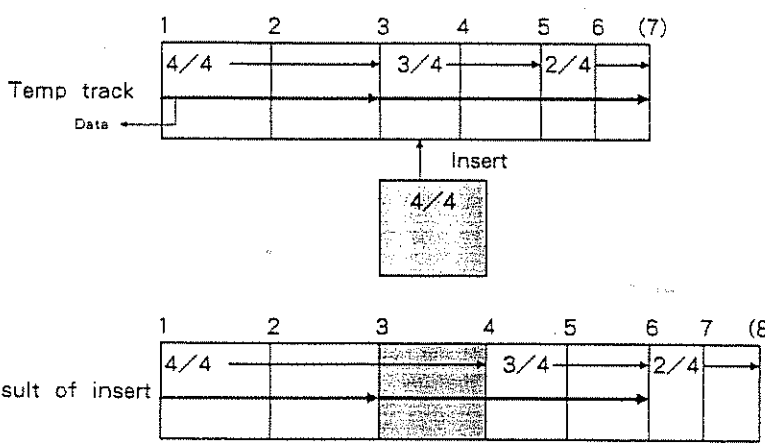
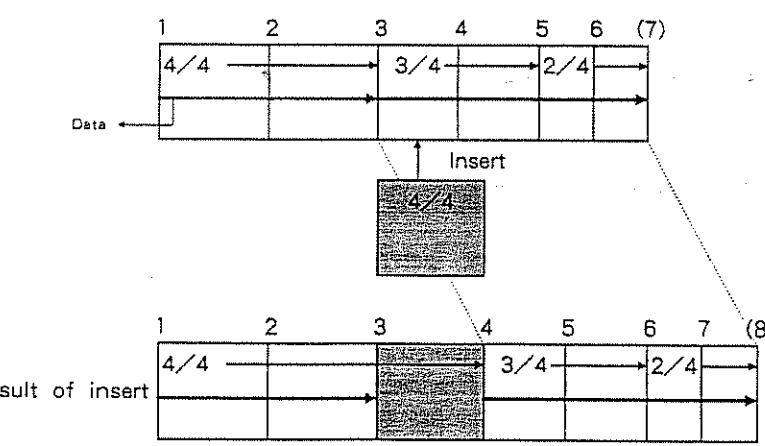
Parameters	Commands
<p>●Inserting measures in the tempo track The measures are inserted. Data in the phrase tracks is not shifted. (Consider the measure lines as moving.)</p>  <p>●Inserting measures into all tracks (All) Measures are inserted, and data is shifted for that amount towards the end.</p> 	
<p>13. Extract STOP</p> <pre> Track 1 Measure 1 Status All for All [100] MIDI Ch All -> Track 1 </pre> <p>Execute </p> <p>This function removes events from a phrase track (source track) to identical positions in another track (destination track). The events on the source track are erased. The events in the destination track will be erased for an amount equal to that extracted, and replaced with the events extracted from the source track.</p>	

[14. Transpose]

Parameters	Commands
<p>Track (Source track) [1]-[16] Specify the track from which data is to be extracted. * A track identical to the destination track cannot be selected.</p> <p>Status (Specifying MIDI Status) [All],[Note],[PAf],[C.Chg],[P.Chg],[CAf],[Bend],[EX] and [TU] Specified MIDI Statuses are extracted.</p> <p>MIDI Ch (Specifying the MIDI Channel) [1]-[16]. Data on the specified MIDI channel is extracted. [All]</p> <p>Measure (Specifying the range for extraction) Extraction can be performed on individual or multiple measures. Specify [Measure] (from which measure) and [for] (for how many measures). [All] will extract down to the last measure.</p> <p>→ Track (Destination track) [1]-[16] Extracted data is written to the specified track.</p>	<p>F1 Execute This will execute Extract.</p> <p>*When you have selected [Note], [PAf], [C.Chg.] or [P.Chg], be sure to set the range for the extraction.</p> <p>* The value of "Note # Range" for [Note] and [PAf] can also be entered using the keyboard.</p>
<div data-bbox="151 974 938 1195" style="border: 1px solid black; padding: 5px; margin-bottom: 10px;"> <p>14. Transpose STOP</p> <p>Track 1-16 Measure 1 MIDI Ch All for All [100] Transpose 0 Note# Range 0[C -]-127[G 9]</p> <p>Execute --- --- --- ---</p> </div> <p>This function shifts the pitch (note events or polyphonic aftertouch) up or down.</p> <p>*If the transposed note number becomes lower than 0 or higher than 127, it will be automatically changed to 0 or 127, and cannot be returned to the original number even by transposing it up or down later.</p> <p>Track (Track to be edited) [1]-[16]. Specify the track to be transposed. [1-16]</p> <p>MIDI Ch (Specifying the MIDI Channel) [1]-[16]. Data only on the specified MIDI channel can be transposed. [All]</p> <p>Transpose (Amount of transposition) [-24]-[+ 24] [- 24] - [+ 24] Specify the number of half-steps to be transposed. The maximum amount of transposition is - 2 or + 2 octaves.</p> <p>Measure (Specifying the range for transposition) Transposition can be performed on individual or multiple measures. Specify [Measure] (from which measure) and [for] (for how many measures). [All] will transpose down to the last measure.</p>	<p>F1 Execute This will execute the transposition.</p>

Parameters	Commands
<p>Note # Range (Specifying the sound range) [0]-[127] Data only of the specified sound range can be transposed. Specify the range by note number. Middle C is 60 (C4). You also can press keys on the keyboard to enter this.</p>	
<pre> 15.Chg. Velocity STOP ----- Track 1-16 Measure 1 MIDI Ch All for All [100] Magnify 1.0 Note# Range Bias 0 0[C -]-127[G 9] ----- Execute --- --- --- --- </pre>	
<p>This function allows you to alter note velocities for the note events in a phrase track.</p> <p>*If the altered velocity becomes lower than 1 or higher than 127, it will be automatically changed to 1 or 127, and cannot be returned to the original value by re-performing Change Velocity.</p> <p>Track (Track to be edited) [1]-[16]. Specify the track to be edited. [1-16]</p> <p>MIDI Ch (Specifying the MIDI Channel) [1]-[16], Data only on the specified MIDI channel can be edited. [All]</p> <p>Magnify (The magnification of velocity change) [0.0]-[2.0] This is the parameter used to exaggerate or compress the velocity value. When it is set to 1.0, there is no change in the dynamic range.</p> <p>Bias (The amount of velocity change) [-99]-[99] Bias allows you to shift the overall velocity amount up or down.</p> <p>Velocity value is expressed by the equation : $y = a (x - 64) + b + 64$ whereas : y = Altered velocity value. x = Velocity value before alteration. a = Magnification b = Bias</p> <div style="display: flex; justify-content: space-around;"> <div data-bbox="256 1606 602 1904"> <p>Magnify</p> </div> <div data-bbox="644 1606 991 1904"> <p>Bias</p> </div> </div>	<p>F1 Execute This will execute Change Velocity.</p>

[16. Change MIDI Ch]

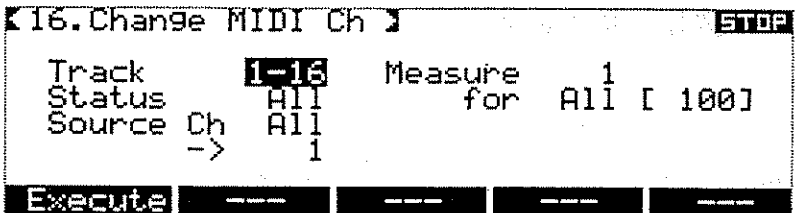
Parameters	Commands
<p>Measure (Specifying the range for Change Velocity) Change Velocity can be performed on individual or multiple measures. Specify [Measure] (from which measure) and [for] (for how many measures). [All] will edit down to the last measure.</p> <p>Note # Range (Specifying the sound range) [0]-[127] Data of the specified sound-range can be edited. Specify the range with a note number. Middle C is 60 (C4). You also can press keys on the keyboard to enter this.</p>	
 <p>This function allows you to change the MIDI channels of the events in a phrase track.</p> <p>*When separate data for an identical MIDI-channel-is created in one track as a result of Change MIDI Channel, the data cannot be separated later.</p> <p>Track (Track to be edited) [1]-[16]. Specify the track to be edited. [1-16]</p> <p>Status (Specifying MIDI Status) [All],[Note],[PAf],[C.Chg],[P.Chg],[CAf] and [Bend] Specified MIDI Statuses only are changed.</p> <p>Source Ch (Source MIDI Channel) [1]-[16] [All] Specify the MIDI channel to be changed.</p> <p>→ (New MIDI Channel) [1]-[16] Specify the new MIDI channel.</p> <p>Measure (Specifying the range) Change MIDI Channel can be performed on individual or multiple measures. Specify [Measure] (from which measure) and [for] (for how many measures). [All] will edit down to the last measure.</p>	<p>F1 Execute This will execute Change MIDI Channel.</p> <p>*When you have selected [Note], [PAf], [C.Chg.] or [P.Chg], be sure to set the range for Change MIDI Channel.</p> <p>*The value of "Note # Range" for [Note] and [PAf] can also be entered using the keyboard.</p>

Parameters	Commands
<div style="border: 1px solid black; padding: 5px;"> <p>[17.Ch9. Gate Time] STOP</p> <p>Track 1-16 Measure 1</p> <p>MIDI Ch All for All [100]</p> <p>Magnify 1.0 Note# Range</p> <p>Bias 0 0[C -]-127[G 9]</p> <p>Execute --- --- --- ---</p> </div>	
<p>This function allows you to edit the gate time of note events in a phrase track.</p>	
<p>*If the edited gate time becomes lower than 1 or higher than 65535, it will be automatically changed to 1 or 65535, and cannot be returned to the original value by re-using Change Gate Time later.</p>	
<p>F1 Execute This will execute Change Gate Time.</p>	
<p>Track (Track to be edited) [1]-[16], Specify the track to be edited. [1-16]</p>	
<p>MIDI Ch (Specifying the MIDI Channel) [1]-[16], Data only on the specified MIDI channel can be edited. [All]</p>	
<p>Magnify (The magnification of gate-time change) [0.0]-[2.0] This is the parameter used to exaggerate or compress the gate time value. When it is set to 1.0, there is no change to the gate time.</p>	
<p>Bias (The amount of gate time change) [-99]-[99] Bias allows you to shift the gate time amount up or down.</p> <p style="margin-left: 40px;">Gate time value is expressed by the equation :</p> <p style="margin-left: 40px;">$y = ax + b$</p> <p style="margin-left: 40px;">whereas :</p> <p style="margin-left: 40px;">y = Altered gate time value. x = Gate time value before alteration.</p> <p style="margin-left: 40px;">a = Magnification b = Bias</p>	
<div style="display: flex; justify-content: space-around;"> <div style="text-align: center;"> <p>Magnify</p> </div> <div style="text-align: center;"> <p>Bias</p> </div> </div>	

[18. Shift Clock]

Parameters	Commands
<p>Measure (Specifying the range for Change Gate Time) Change Gate Time can be performed on individual or multiple measures. Specify [Measure] (from which measure) and [for] (for how many measures). [All] will edit down to the last measure.</p> <p>Note # Range (Specifying the sound range) [0]-[127] Data of the specified sound range can be edited. Specify the range with a note number. Middle C is 60 (C4). You also can press keys on the keyboard to enter this.</p>	
<div data-bbox="161 697 949 910" style="border: 1px solid black; padding: 5px; margin-bottom: 10px;"> <p>18. Shift Clock STOP</p> <p>Track 1-16 Measure 1 Status All for All [100] MIDI Ch All Bias 0</p> <p>Execute --- --- --- ---</p> </div> <p>This function shifts events in a track at 1 clock (1/96 of a quarter note) increments.</p> <p>Track (Track to be edited) [1]-[16]. Specify the track to be edited. [1-16] [T]</p> <p>Status (Specifying MIDI Status) [All],[Note],[PAf],[C.Chg],[P.Chg],[CAf],[Bend],[EX],[TU] and [Tempo (Only when T has been selected for Track.)] Data for specified MIDI Statuses only can be shifted.</p> <p>MIDI Ch (Specifying the MIDI Channel) [1]-[16] [All] Only data on the specified MIDI channel can be shifted.</p> <p>Bias (The amount of Shift) [-99]-[99] Specified in clock pulses (1/96 of a quarter note). + values will cause a shift backward.</p> <p>Measure (Specifying the range for Shift) Shift Clock can be performed on individual or multiple measures. Specify [Measure] (from which measure) and [for] (for how many measures). [All] will edit down to the last measure.</p>	<p>F1 Execute This will execute Shift Clock.</p> <p>*When you have selected [Note], [PAf], [C.Chg.] or [P.Chg], be sure to set the range.</p> <p>*The value of "Note # Range" for [Note] and [PAf] can also be entered using the keyboard.</p>

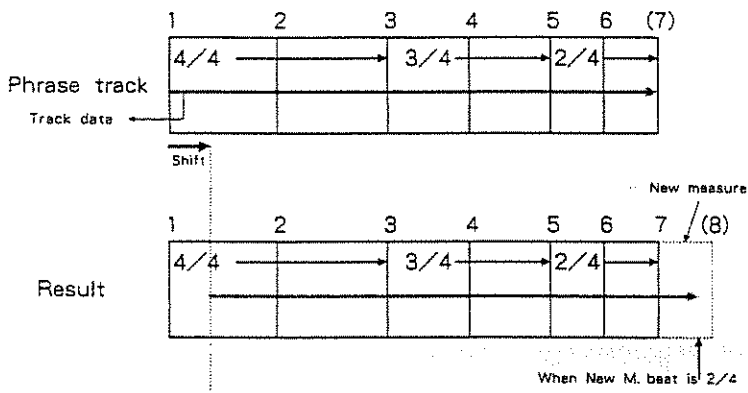
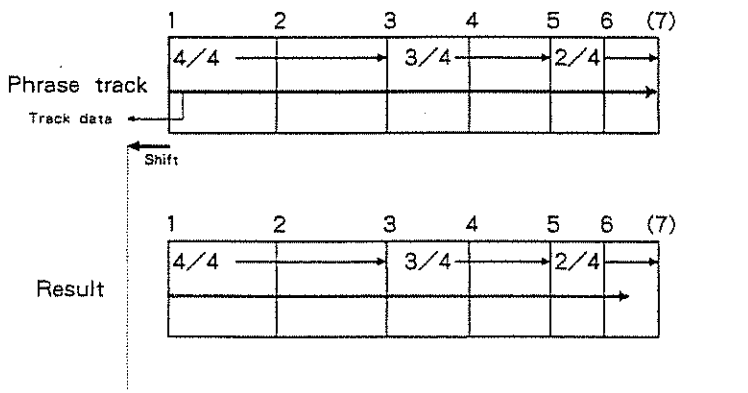
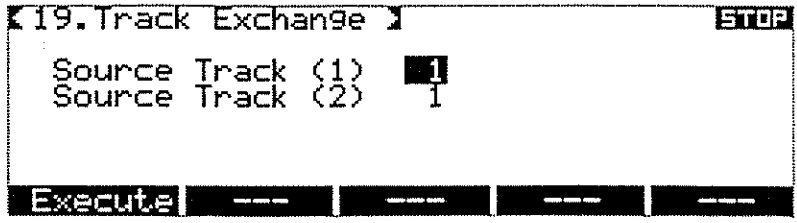
Parameters	Commands
<p>● When data shifts toward the end (with a + setting for Bias)</p>  <p>When it extends beyond the final measure, a new measure is created automatically, in accord with the setting for New M. Beat made when REC was pressed from the [4. Recorder] screen. The extra data then goes there.</p> <p>● When data shifts to the top (with a - setting for Bias)</p>  <p>Data that results as occurring before the first measure, is fixed to a location at the beginning of the first beat of the first measure. (M/B/C = 1/1/0)</p>	
 <p>This function allows you to exchange data between two phrase tracks.</p>	

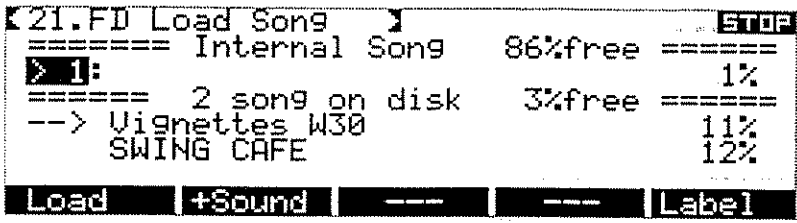
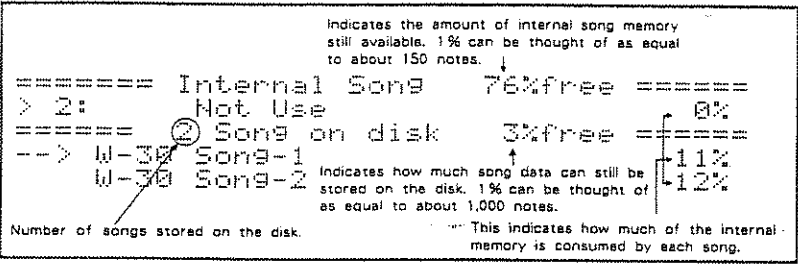
Parameters	Commands
<p>Source Track (1) (The first track to be exchanged) [1]-[16] Specify the one of the tracks to be exchanged.</p> <p>Source Track (2) (The second track to be exchanged) [1]-[16] Specify the other track to be exchanged.</p>	<p>F1 Execute This executes the Track Exchange.</p>
 <p>This allows you to load individual songs from a data disk to the W-30's internal memory. Insert a data disk into the disk drive.</p>  <p>Indicates the amount of internal song memory still available. 1% can be thought of as equal to about 150 notes.</p> <p>Indicates how much song data can still be stored on the disk. 1% can be thought of as equal to about 1,000 notes.</p> <p>This indicates how much of the internal memory is consumed by each song.</p> <p>Number of songs stored on the disk.</p>	<p>F1 Load This will execute Load Song.</p> <p>F2 + Sound When a sound & song disk is being used, sound data will be loaded (Load Set) together with song data.</p> <p>F5 Label This allows you to check the disk label.</p>
<p>Internal Song (Destination Song number) [1]-[20] Select the destination song number where the source song is to be loaded.</p> <p>Song on disk (Song to be loaded) --> Position the song to be loaded at the top line. When more than one song is stored on the disk, song names can be called in sequence by rotating the Value dial. The Numerical Keypad cannot be used.</p>	

Parameters	Commands
<pre> <22.FD Save Song > ===== Internal Song 76%free ===== > 1: Uignettes W30 11% 2: SWING CAFE 12% 3: Not Use 0% 4: Not Use 0% ===== 2 song on disk 3%free ===== Save +Sound --- --- Label </pre> <p>This allows you to save a song from the W-30's internal memory to a data disk. Insert a data disk into the disk drive.</p> <div style="border: 1px solid black; padding: 5px; margin: 10px 0;"> <pre> Indicates the amount of internal song memory still available. 1% can be thought of as equal to about 150 notes. ===== Internal Song 76%free ===== > 1: W-30 Song-1 11% 2: W-30 Song-2 12% 3: Not Use 0% 4: Not Use 0% ===== 2 Song on disk 3%free ===== Number of songs stored on the disk. Indicates how much song data can still be stored on the disk. 1% can be thought of as equal to about 1,000 notes. This indicates how much of the internal memory is consumed by each song. </pre> </div> <p>Internal Song (Song to be saved) > [1]-[20] Position the song to be saved at the top line.</p> <p>*On disk, songs are classified by song name (not with song numbers). Be sure to put a song name to every song before saving it.</p> <p>If a song with the same name as the selected internal song already exists on the disk, the message "Overwrite OK ?" appears. In this case, executing Save Song will replace the existing song with the internal song. To retain the previous song on the disk, change the internal song's name with [3. Song Parameter] before saving it (page 113).</p>	<p>F1 Save This will execute Save Song.</p> <p>F2 + Sound With sound & song disks, this saves the sound data along with the song. (Save Set) FUNC data (parameters in the [32. Part Set] screen) are saved to both the song and sound (page 98).</p> <p>F5 Label This will allow you to check the disk label.</p>

<pre> <23.FD Delete Song > ===== 2 song on disk 3%free ===== --> Uignettes W30 11% SWING CAFE 12% Delete --- --- --- Label </pre> <p>This function allows you to delete individual songs from a disk.</p> <div style="border: 1px solid black; padding: 5px; margin: 10px 0;"> <pre> Indicates how much song data can still be stored on the disk. 1% can be thought of as equal to about 1,000 notes. ===== 2 Song on disk 3%free ===== --> W-30 Song-1 11% W-30 Song-2 12% Number of songs stored on the disk. Indicates how much of the internal memory is consumed by each song. </pre> </div>	<p>F1 Delete Executes Delete of a song</p> <p>F5 Label Allows you to check the disk label</p>
--	---

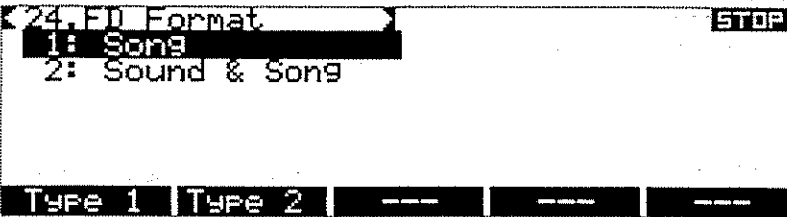
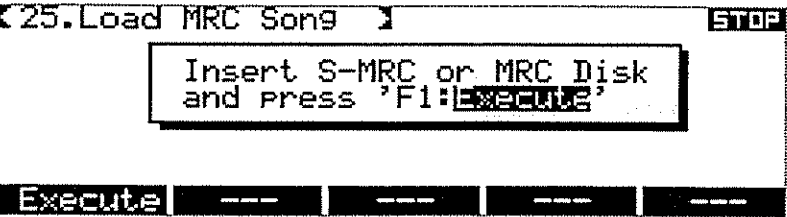
Parameters	Commands
<p>→ (Song to be deleted) Position the song to be deleted at the top line. When more than one song is stored on the disk, song names can be called in sequence by rotating the Value dial. The Numerical Key pad cannot be used.</p>	
 <p>The Format function is used to create new W-30 software disks which can be used for storing your song files. Brand new disks, or disks previously used for other units cannot store W-30 data unless they are formatted first. There are two types of data disks for the W-30.</p> <div style="display: flex; justify-content: space-around;"> <div style="border: 1px solid black; padding: 5px; width: 45%;"> <p style="text-align: center;">Sound & Song Disk</p> <p style="text-align: center;">Songs 64 songs approx. 7,000 steps</p> <p style="text-align: center;">Sound</p> </div> <div style="border: 1px solid black; padding: 5px; width: 45%;"> <p style="text-align: center;">Song Disk</p> <p style="text-align: center;">Songs 64 songs approx. 100,000 steps</p> </div> </div>	<p>F1 Type 1 Creates a Song Disk.</p> <p>F2 Type 2 Creates a Sound & Song Disk.</p> <p>A Label, using up to 11 characters, can be assigned to the disk. Disk Labels, once created, cannot be altered.</p> <p>F1 Format Formats the disk.</p>
 <p>This function allows you to load songs from MRC-500/MRC-300/S-MRC disks.</p> <p>When the message "Insert S-MRC or MRC Disk and press 'F1: Execute'" appears, insert the MRC-500/MRC-300/S-MRC disk into the disk drive, then press F1.</p>	<p>F1 Load This will execute Load Song.</p>

Parameters	Commands
<p>Indicates the amount of internal song memory still available. 1% can be thought of as equal to about 150 notes.</p> <pre> ===== Internal Song 43%free ===== > 1:Song-1 ===== ② Song on disk 3%free ===== --> MRC Song-1 MRC Song-2 </pre> <p>Indicates how much song data can still be stored on the disk. 1% can be thought of as equal to about 1,000 notes.</p> <p>Number of songs stored on the disk. This indicates how much of the internal memory is consumed by each song.</p>	
<p>Internal Song (Destination Song number)</p> <p>[1]-[20] Select the destination song number where the source song is to be loaded.</p> <p>→ (Source song to be loaded)</p> <p>--> Position the song to be loaded at the top line. When more than one song is stored on the disk, song names can be called in sequence by rotating the Value dial. The Numerical Key pad cannot be used.</p> <p>*Data on the rhythm track is converted, and is loaded into a phrase track.</p> <p>Super-MRC →Track 9 MRC-500, MRC-300 →Track 5 (see page 100.)</p>	

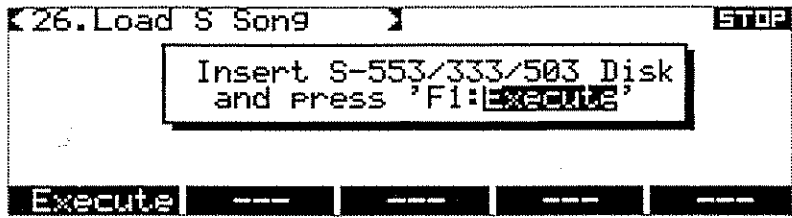

This function allows you to load a song from S-50 (SYS-503), S-550 (SYS-553), and S-330 (SYS-333) song disks.

Songs on the above disks are composed of patterns. However, when loaded the patterns are joined together as a whole. In addition, names of songs on such disks can have up to 44 characters, but the W-30 can accept only a maximum of 28, so the 29th character onwards is ignored. (see page 100.)

When the message "Insert S-553/333/503 Disk and press 'F1:Execute'" appears, insert the SYS-553/333/503 disk into the disk drive, then press **F1**.

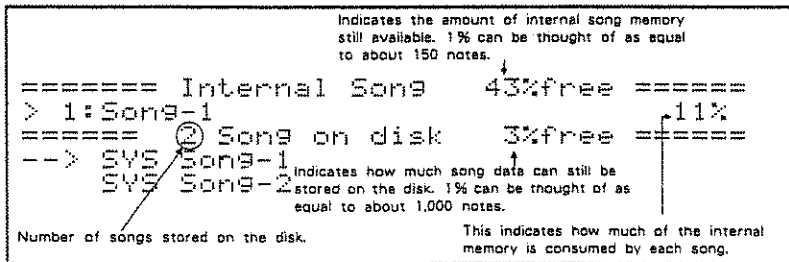

[27. Save S-MRC Disk]

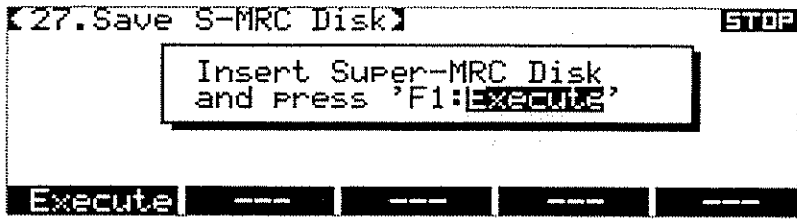
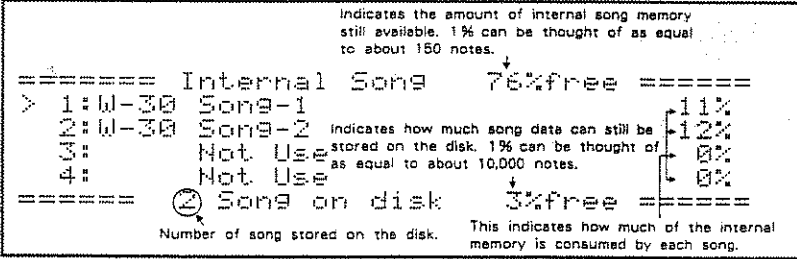
Parameters	Commands
<p>Internal Song (Destination Song number) [1]-[20] Select the destination song number where the source song is to be loaded.</p> <p>→ (Song to be loaded) Position the song to be loaded at the top line. When more than one song is stored on the disk, song names can be called in sequence by rotating the Value dial. The Numerical Key pad cannot be used.</p>	<p>F1 Load This will execute Load Song.</p>
 <p>This function allows you to save a song in the W-30's internal memory onto a disk formatted with Super-MRC.</p> <p>When the message "Insert Super-MRC Disk and press 'F1:Execute'" appears insert the Super-MRC disk and press the F1 button.</p>  <p>* Song data in the W-30 cannot be saved on MRC-500/300 disks.</p> <p>Internal Song (Song to be saved) > [1]-[20] Position the song to be saved at the top line.</p> <p>Super-MRC can process only eight phrase tracks, therefore, tracks 9 to 16 on the W-30 are ignored. Move song data in tracks 9 to 16 onto tracks 1 to 8 using the [8. Merge] or [9. Copy] functions before saving them on a Super-MRC disk.</p> <p>A song name with Super-MRC can have only 13 characters, while the W-30 can use up to 28 characters. This means that only the first 13 characters are recognized on the Super-MRC disk. On disk, song are classified by song name (not with song numbers). Be sure to put a song name to every song before saving it. (see page 101.)</p> <p>You cannot save the song if there is already a song existing that has the same name.</p>	<p>F1 Save This will execute Save Song.</p>

Parameters	Commands
<div data-bbox="244 327 1025 549" style="border: 1px solid black; padding: 5px;"> <p>28.FD Copy STOP</p> <p style="text-align: center;">WARNING! If you execute 'FD Copy' you'll lose the Sound & Song Data. Insert Source Disk</p> <p>Execute --- --- --- ---</p> </div> <p>This function allows you to make a copy of W-30 disks. Have a source disk and destination disk ready, and insert the source disk first into the disk drive.</p> <p>*Executing FD Copy will erase any existing sound and song data in the W-30's internal memory. If you wish to retain the data, save it onto a data disk before executing FD Copy.</p> <p>*The FD Copy function cannot copy any disks other than those for the W-30, S-50 (Ver.1, 2), S-330, S-550, SYS-503, SYS-333 or SYS-553.</p>	<p>F1 Execute</p> <p>This will load data from the source disk.</p> <p>When the message "Insert New Disk" appears, remove the disk, then insert the destination disk to be copied.</p> <p>F1 Execute</p> <p>After formatting the disk, this will save the loaded data.</p>
<div data-bbox="244 932 1025 1153" style="border: 1px solid black; padding: 5px;"> <p>29.Song Transfer STOP</p> <p style="text-align: center;">WARNING! If you execute 'Transfer' you'll lose the Sound & Song Data. Insert Source Disk</p> <p>Dir --- --- --- ---</p> </div> <p>This function allows you to copy a number of songs on one disk to a second disk. Songs on the second disk are erased if they have the same song name as any on the first disk.</p> <p>①Have the two disks ready, and insert the first disk into the disk drive ...</p> <p>*Executing Song Transfer will erase any existing sound and song data in the W-30's internal memory. If you wish to retain the data, save it onto a data disk before executing Song Transfer.</p> <p>*Song Transfer cannot be carried out on disks other than those for the W-30.</p> <div data-bbox="265 1542 1053 1702" style="border: 1px solid black; padding: 5px;"> <pre> ===== Song on disk 3%free ===== --> W-30 Song-1 ↑ 11% W-30 Song-2 ↓ 12% </pre> <p>Number of songs stored on the disk. This indicates the percentage of internal memory consumed by each song.</p> </div> <p>②Using the Value dial, position the song to be copied on the top line (-->), then press F5.</p> <p>The selected song name will be displayed in inverse.</p> <p>Repeat step 2 until you have selected all songs you wish to copy.</p>	<p>F1 Dir</p> <p>This will indicate all the songs stored on the disk.</p> <p>F5 Select</p> <p>This alternately selects or cancels the song.</p>

[30. Track Info.]

Parameters	Commands
<p>③ Execute Song Transfer.....</p> <p>The song names currently being loaded are shown in the display. When loading has finished, the message "Insert Destination Disk" appears.</p> <p>④ Remove the disk then insert the second (destination) disk.....</p> <p>The song names currently being saved are shown in the display. When the saving is finished, the message "WARNING!" appears.</p> <p>*If the disk contains any song that has the same name as one in internal memory (in the loaded song data), the message "Overwrite OK?" appears. To retain the existing song on the disk, load song data from the first disk beforehand and change the relevant song name with [3. Song Parameter], and return the data to the disk before using Song Transfer.</p>	<p>F1 Trans This will load the selected songs.</p> <p>F1 Trans This will save the loaded songs onto the disk.</p> <p>F1 Yes This will replace the song on the disk with the one in the internal memory.</p> <p>F2 No This will move you to the next song without saving the current song.</p>

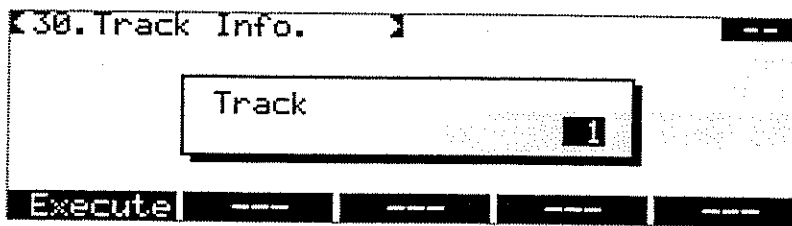

This function allows you to check the contents of data in a phrase track (see page 97).

* To select a song, use the [3. Song Parameter] or [4. Recorder] screens.

Select the track to be checked.....

Track	1	Channel 10										Channel 16					
Channel	→ 1	2	3	4	5	6	7	8	9	0	1	2	3	4	5	6	
Note	*	
PRF	*	
C. CHG	
P. CHG	*	

* ... exists nonexistent

F1 Execute
Press this when you have selected a track.

Parameters	Commands
<p>[Note] Note messages [PAf] Polyphonic Aftertouch messages [C.Chg] Control Change messages [P.Phg] Program Change messages</p> <p>↑ F5 Page ↓</p> <p>[CAf] Channel Aftertouch messages [Bend] Bender messages [EX] System Exclusive messages [TU] Tune Request messages</p> <p>*[EX] and [TU] bear no relevance to channels. When a track contains these messages, "Exist" is indicated and if not, "Not exist".</p>	<p>F1 Select Press this to change the track to be checked.</p>

3. SOUND MODE

Parameters	Commands																																																																																																												
<pre> 32 Part Set 09 Ch Patch Out Level A 8 1 P 4 Mellow Piano (1) 127 B 6 10 P 9 Drums/Perc (1) 127 C 2 2 P 8 FingeredBass (1) 127 D 0 -- P 4 Mellow Piano (1) 127 [Outout Mode Mix] Page [INIT [M. Tune [KE PRM] --- </pre>	<p>F1 Page</p> <p>Switches between display of Parts A - D and E - H.</p>																																																																																																												
<p>This function allows you to set each Part.</p>																																																																																																													
<p>V** (Voice Mode) (FUNC Parameter) (Song Parameter)</p> <p>The W-30 is 16 voice polyphonic. (This might be reduced depending on the conditions.) You can select one of the following Voice Modes determining how these 16 voices are played.</p>																																																																																																													
<p>[VAL] (Last Note Priority Auto Mode)</p> <p>In this mode, the Patch assigned to the Part is played by Note messages received on the relevant channel. If the received Note messages exceed 16 voices, the fainter sounds will be sacrificed for new notes.</p>																																																																																																													
<p>[VAF] (First Note Priority Auto Mode)</p> <p>The Patch assigned to the Part is played by Note messages received on the relevant channel. If the received Note messages exceed 16 voices, the later messages are ignored.</p>																																																																																																													
<p>[V1]-[V22] (Fixed Voice Mode)</p> <p>This mode assigns the 16 voices to the 8 Parts, in 22 possible ways, as shown below. If the received Note messages exceed the maximum number of voices which can sound, the later sounds will be ignored.</p>																																																																																																													
<table border="1" style="width: 100%; border-collapse: collapse; text-align: center;"> <thead> <tr> <th>Voice Mode</th> <th>1</th> <th>2</th> <th>3</th> <th>4</th> <th>5</th> <th>6</th> <th>7</th> <th>8</th> <th>9</th> <th>10</th> <th>11</th> </tr> </thead> <tbody> <tr> <td>A</td> <td>16</td> <td>14</td> <td>12</td> <td>12</td> <td>10</td> <td>10</td> <td>10</td> <td>8</td> <td>8</td> <td>8</td> <td>8</td> </tr> <tr> <td>B</td> <td>0</td> <td>2</td> <td>4</td> <td>2</td> <td>6</td> <td>4</td> <td>2</td> <td>8</td> <td>6</td> <td>4</td> <td>4</td> </tr> <tr> <td>C</td> <td>0</td> <td>0</td> <td>0</td> <td>2</td> <td>0</td> <td>2</td> <td>2</td> <td>0</td> <td>2</td> <td>4</td> <td>2</td> </tr> <tr> <td>D</td> <td>0</td> <td>0</td> <td>0</td> <td>0</td> <td>0</td> <td>0</td> <td>2</td> <td>0</td> <td>0</td> <td>0</td> <td>2</td> </tr> <tr> <td>E</td> <td>0</td> <td>0</td> <td>0</td> <td>0</td> <td>0</td> <td>0</td> <td>0</td> <td>0</td> <td>0</td> <td>0</td> <td>0</td> </tr> <tr> <td>F</td> <td>0</td> <td>0</td> <td>0</td> <td>0</td> <td>0</td> <td>0</td> <td>0</td> <td>0</td> <td>0</td> <td>0</td> <td>0</td> </tr> <tr> <td>G</td> <td>0</td> <td>0</td> <td>0</td> <td>0</td> <td>0</td> <td>0</td> <td>0</td> <td>0</td> <td>0</td> <td>0</td> <td>0</td> </tr> <tr> <td>H</td> <td>0</td> <td>0</td> <td>0</td> <td>0</td> <td>0</td> <td>0</td> <td>0</td> <td>0</td> <td>0</td> <td>0</td> <td>0</td> </tr> </tbody> </table>		Voice Mode	1	2	3	4	5	6	7	8	9	10	11	A	16	14	12	12	10	10	10	8	8	8	8	B	0	2	4	2	6	4	2	8	6	4	4	C	0	0	0	2	0	2	2	0	2	4	2	D	0	0	0	0	0	0	2	0	0	0	2	E	0	0	0	0	0	0	0	0	0	0	0	F	0	0	0	0	0	0	0	0	0	0	0	G	0	0	0	0	0	0	0	0	0	0	0	H	0	0	0	0	0	0	0	0	0	0	0
Voice Mode	1	2	3	4	5	6	7	8	9	10	11																																																																																																		
A	16	14	12	12	10	10	10	8	8	8	8																																																																																																		
B	0	2	4	2	6	4	2	8	6	4	4																																																																																																		
C	0	0	0	2	0	2	2	0	2	4	2																																																																																																		
D	0	0	0	0	0	0	2	0	0	0	2																																																																																																		
E	0	0	0	0	0	0	0	0	0	0	0																																																																																																		
F	0	0	0	0	0	0	0	0	0	0	0																																																																																																		
G	0	0	0	0	0	0	0	0	0	0	0																																																																																																		
H	0	0	0	0	0	0	0	0	0	0	0																																																																																																		
<table border="1" style="width: 100%; border-collapse: collapse; text-align: center;"> <thead> <tr> <th>Voice Mode</th> <th>12</th> <th>13</th> <th>14</th> <th>15</th> <th>16</th> <th>17</th> <th>18</th> <th>19</th> <th>20</th> <th>21</th> <th>22</th> </tr> </thead> <tbody> <tr> <td>A</td> <td>8</td> <td>6</td> <td>6</td> <td>6</td> <td>6</td> <td>6</td> <td>4</td> <td>4</td> <td>4</td> <td>4</td> <td>2</td> </tr> <tr> <td>B</td> <td>2</td> <td>6</td> <td>6</td> <td>4</td> <td>4</td> <td>2</td> <td>4</td> <td>4</td> <td>4</td> <td>2</td> <td>2</td> </tr> <tr> <td>C</td> <td>2</td> <td>4</td> <td>2</td> <td>4</td> <td>2</td> <td>2</td> <td>4</td> <td>4</td> <td>2</td> <td>2</td> <td>2</td> </tr> <tr> <td>D</td> <td>2</td> <td>0</td> <td>2</td> <td>2</td> <td>2</td> <td>2</td> <td>4</td> <td>2</td> <td>2</td> <td>2</td> <td>2</td> </tr> <tr> <td>E</td> <td>2</td> <td>0</td> <td>0</td> <td>0</td> <td>2</td> <td>2</td> <td>0</td> <td>2</td> <td>2</td> <td>2</td> <td>2</td> </tr> <tr> <td>F</td> <td>0</td> <td>0</td> <td>0</td> <td>0</td> <td>0</td> <td>2</td> <td>0</td> <td>0</td> <td>2</td> <td>2</td> <td>2</td> </tr> <tr> <td>G</td> <td>0</td> <td>0</td> <td>0</td> <td>0</td> <td>0</td> <td>0</td> <td>0</td> <td>0</td> <td>0</td> <td>2</td> <td>2</td> </tr> <tr> <td>H</td> <td>0</td> <td>0</td> <td>0</td> <td>0</td> <td>0</td> <td>0</td> <td>0</td> <td>0</td> <td>0</td> <td>0</td> <td>2</td> </tr> </tbody> </table>		Voice Mode	12	13	14	15	16	17	18	19	20	21	22	A	8	6	6	6	6	6	4	4	4	4	2	B	2	6	6	4	4	2	4	4	4	2	2	C	2	4	2	4	2	2	4	4	2	2	2	D	2	0	2	2	2	2	4	2	2	2	2	E	2	0	0	0	2	2	0	2	2	2	2	F	0	0	0	0	0	2	0	0	2	2	2	G	0	0	0	0	0	0	0	0	0	2	2	H	0	0	0	0	0	0	0	0	0	0	2
Voice Mode	12	13	14	15	16	17	18	19	20	21	22																																																																																																		
A	8	6	6	6	6	6	4	4	4	4	2																																																																																																		
B	2	6	6	4	4	2	4	4	4	2	2																																																																																																		
C	2	4	2	4	2	2	4	4	2	2	2																																																																																																		
D	2	0	2	2	2	2	4	2	2	2	2																																																																																																		
E	2	0	0	0	2	2	0	2	2	2	2																																																																																																		
F	0	0	0	0	0	2	0	0	2	2	2																																																																																																		
G	0	0	0	0	0	0	0	0	0	2	2																																																																																																		
H	0	0	0	0	0	0	0	0	0	0	2																																																																																																		

Parameters	Commands
<p>Ch (Receive Channel) (FUNC Parameter) (Song Parameter)</p> <p>[1]-[16] This is the receive channel of each Part.</p> <p>[--] All MIDI messages are ignored, therefore, no sound is generated. To minimize delay, turn off Parts which are not in use.</p> <p>*The W-30 allows you to set the receive channels for Parts A to H to the same channel number (s). This however, will cause slight delays in starting the sounds, in particular, when the Voice Mode = VAL (Last Note Priority Auto Mode).</p>	
<p>Patch (Patch to be played) (FUNC Parameter) (Song Parameter)</p> <p>[P1]-[P16] This is the Patch played by each Part.</p>	<p>F2 INIT This will initialize FUNC Parameters. (see page 184.)</p>
<p>Out (Output Sockets) (Patch Parameter)</p> <p>[1]-[8] When played the Patch is output from the socket number set here.</p> <p>[T] Output takes place on a per tone basis. The socket from which each tone will be output is set as a Tone Parameter. (page 154) With output on a per tone basis, the number of voices capable of being output is reduced, so certain sounds may be left out.</p>	
<p>Level (Volume of each Part) (FUNC Parameter) (Song Parameter)</p> <p>[0]-[127] This sets the volume of the Part.</p> <p>*You can change this parameter with the volume messages sent from an external MIDI device. To do so, set the receive switch [Vol] to "ON" under [33. MIDI RX Set].</p>	
<p>Output Mode (Change of Output Mode) (FUNC Parameter) (Song Parameter)</p> <p>This selects either [Multi], whereby particular patches or tones can be assigned voices that are output through multi output sockets; or [Mix], which provides a mixed output from Multi Output Socket # 1.</p> <p>The headphone socket's output is the same as that of Multi Output Socket # 1.</p> <p>[Multi] (Multi Out) Signals are sent through the sockets set for each Patch. The exact same signal as sent through Multi Output Socket 1 is from the Headphone Socket.</p> <p>[Mix] (Mix Out) The mixed signal is sent out through the Headphone Socket and Multi Output Socket 1. The other Multi Output Sockets are inactive.</p>	
<p>F3 M. Tune Master Tune (Master Tune) (FUNC Parameter)</p> <p>[-64]-[0]-[63] This performs the overall tuning of the W-30. At 0, the W-30 is played in the same pitch as set under Tone parameters.</p>	
<p>F4 KB PRM (Keyboard Parameter)</p>	
<p>Ch (Keyboard Channel) (Configuration Parameter)</p> <p>[1]-[16] This sets the MIDI transmit channel for performance data played on the keyboard. If you play the keyboard while recording, the performance is recorded as being for the channel set here.</p>	

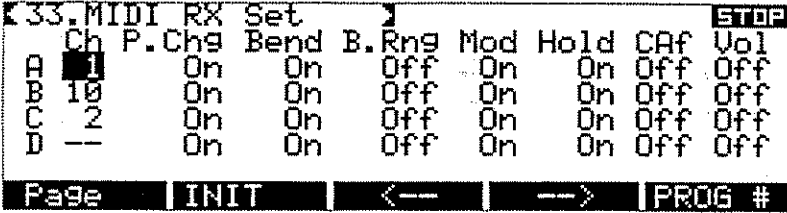

Parameters	Commands
<p>Octave (Keyboard Octave Shift) (Configuration Parameter) [-2]-[+ 2] At value [0], the sound range from C2 to C7 on the keyboard can be played. By changing values, the sound range can be shifted above or below in one octave units.</p> <p>P (Program Change number that the keyboard transmits)..... [1]-[128] The Program Change number selected here will be transmitted on the set keyboard channel by pressing the [F1] button.</p> <p>I (MIDI Switch between keyboard and internal sound module) (Configuration Parameter) [On] / [Off] (Local On/Off) "On" will transmit the keyboard's performance data to the internal sound module.</p> <p>E (MIDI Switch between keyboard and MIDI OUT) (Configuration Parameter) [On] / [Off] "On" will transmit the keyboard's performance data from MIDI OUT.</p>	<p>[F1] PG Send This button sends the Program Change number you have selected.</p> <p>[F4] INT Toggles between On and Off.</p> <p>[F5] EXT Toggles between On and Off.</p>
 <p>Settings here determine how each Part responds to MIDI messages.</p> <p>Ch (Receive Channel) (FUNC Parameter) (Song Parameter) [1]-[16]. This sets the receive channel of each Part. [--] Ignores all MIDI messages.</p> <p>P.Chg (Program Change) (MIDI Parameter) [On],[Off] This selects whether or not to receive Program Change messages.</p> <p>*The received Program Change messages will change Patches on the W-30. The Program Change numbers and corresponding Patches on the W-30 are set with [F5] (PROG #).</p> <p>Bend (Bender) (MIDI Parameter) [On],[Off] This selects whether or not to receive Bender messages.</p> <p>B. Rng (Bend Range) (MIDI Parameter) [On],[Off] This selects whether or not to receive Bend Range messages (Control Change RPN No.0).</p>	<p>[F1] Page Switches between display of Parts A - D and E - H.</p> <p>[F2] INIT Initializes all parameters, except "Ch", in this screen. (page 184)</p> <p>[F3] ← This will move the cursor to the left.</p> <p>[F4] → This will move the cursor to the right.</p>

Parameters	Commands
<p>Mod (Modulation) (MIDI Parameter) [On],[Off] This selects whether or not to receive Modulation messages (Control Change No. 1).</p> <p>Hold (Hold) (MIDI Parameter) [On],[Off] This selects whether or not to receive Hold messages (Control Change No. 64).</p> <p>CAf (Channel Aftertouch) (MIDI Parameter) [On],[Off] This selects whether or not to receive Channel Aftertouch messages.</p> <p>Vol (Volume) (MIDI Parameter) [On],[Off] This selects whether or not to receive Volume messages (Control Change No.7).</p>	
<p>F5 PROG # (MIDI Parameter)</p> <pre> 34. MIDI Program # STOP P 1 P 2 P 3 P 4 P 5 P 6 P 7 P 8 1 2 3 4 5 6 7 8 P 9 P10 P11 P12 P13 P14 P15 P16 9 10 11 12 13 14 15 16 INIT --- --- --- RX Set </pre> <p>This function allows you to assign Program Change numbers to the W-30's Patches, from 1 to 128.</p> <p>*Be sure that the same Program Change numbers are not assigned to more than one Patch. If the same number is assigned to two Patches, the lower Patch number will take priority.</p>	<p>F1 INIT This will initialize all the parameters in this screen. (see page 184.)</p> <p>F5 RX Set This returns you to [33. MIDI RX Set] screen.</p>
<pre> 36. Patch Parameter STOP [1] Ac Piano Out Level 120 Key Mode Mix Bend Range 2 Key Assign ROT AT Assign MOD Uni-Detune 0 AT Sense 0 V-SW Thresh 80 Oct. Shift 0 V-Mix Ratio 127 Out Assign Out1 COP9 INIT SWEP --- --- </pre> <p>This function allows you to set Patch parameters.</p> <p>[Patch Number] and Patch Name (Patch Parameter) [1]-[16] Call the Patch to be edited. Each Patch can be named using up to 12 characters.</p>	

Parameters	Commands																									
<p>Key Mode <small>(Patch Parameter)</small></p> <p>One of the following five Key Modes can be selected. In any Key Mode, each Tone will sound in accord with a set level curve (see page 163) depending on how hard you play the key. Two Tones, the 1st and 2nd Tones, can be assigned to any key you like in the [37. Patch Split] screen. The Key Mode selection can also be done in the [37. Patch Split] screen.</p> <p>[Norm] (Normal) The 1st Tone assigned will sound.</p> <p>[V - SW] (Velocity Switch) Playing the key harder than a certain level (Velocity Switch Threshold Level) will sound the 2nd Tone, while weaker keypresses will sound the 1st Tone.</p> <p>[Fade] (Velocity Cross-fade) Depending on how hard you play the key, the volume balance of the 1st and 2nd Tones differs. The level curve of the 1st Tone is inverted. Because two voice modules are played by one key in this mode, the number of voices capable of sounding simultaneously is half that of the Normal mode.</p> <p>[Mix] (Velocity Mix) The 1st and 2nd Tone are played simultaneously. Because two voice modules are played by one key in this mode, the number of voices capable of sounding is half that of the Normal mode.</p> <p>[Uni] (Unison) The 1st Tone assigned will sound. Because two voice modules are played by one key in this mode, the possible sounding voices are half of the Normal mode. It is possible to detune one of the sounds slightly with Uni-Detune.</p> <p>For playing stereo sounds, such as by sampling from compact disk, laser disk or DAT, you should sample right and left separately, match the start points, then play in the Mix mode. You should then output each Tone separately from the assigned output socket of the each Tone after setting Out Assign of the Patch to Tone.</p>	<p>F1 Copy This copies parameter settings.</p> <p>F1 1patch This will copy all the parameters of the Patch selected with "Copy from" to the current Patch.</p> <p>F2 1page This will take only the parameters currently in the screen from the source Patch (selected with "Copy from") and copy them to the current Patch.</p> <p>F3 load This will copy the Patch parameters of a Patch residing on a data or system disk, and chosen with "Copy from disk".</p> <p>*The Patch targeted for "Copy from disk" can be selected from among [1] to [16] on a data disk or [1] to [32] on the system disk.</p> <p>F1 1patch This will copy all the Patch parameters of the "Copy from disk" selected Patch to the current Patch. (page 74.)</p> <p>F2 1page This will copy from Patch selected in "Copy from disk" only the parameters currently shown in the screen, to the current Patch.</p>																									
<table border="1" style="width: 100%; border-collapse: collapse;"> <thead> <tr> <th style="width: 20%;"></th> <th style="width: 20%;"></th> <th style="width: 20%; text-align: center;">V-SW</th> <th style="width: 20%; text-align: center;">X-FADE</th> <th style="width: 20%; text-align: center;">V-MIX</th> </tr> </thead> <tbody> <tr> <td style="text-align: center;"> <table border="1" style="width: 100%; border-collapse: collapse;"> <tr> <td style="width: 50%; text-align: center;">1st Tone L. Curve 2</td> <td style="width: 10%; text-align: center;">+</td> <td style="width: 50%; text-align: center;">2nd Tone L. Curve 2</td> </tr> <tr> <td colspan="3" style="text-align: center;">→</td> </tr> </table> </td> <td style="text-align: center;"> Thresh </td> <td style="text-align: center;"> </td> <td style="text-align: center;"> </td> </tr> <tr> <td style="text-align: center;"> <table border="1" style="width: 100%; border-collapse: collapse;"> <tr> <td style="width: 50%; text-align: center;">1st Tone L. Curve 2</td> <td style="width: 10%; text-align: center;">+</td> <td style="width: 50%; text-align: center;">2nd Tone L. Curve 3</td> </tr> <tr> <td colspan="3" style="text-align: center;">→</td> </tr> </table> </td> <td style="text-align: center;"> Thresh </td> <td style="text-align: center;"> </td> <td style="text-align: center;"> </td> </tr> </tbody> </table>			V-SW	X-FADE	V-MIX	<table border="1" style="width: 100%; border-collapse: collapse;"> <tr> <td style="width: 50%; text-align: center;">1st Tone L. Curve 2</td> <td style="width: 10%; text-align: center;">+</td> <td style="width: 50%; text-align: center;">2nd Tone L. Curve 2</td> </tr> <tr> <td colspan="3" style="text-align: center;">→</td> </tr> </table>	1st Tone L. Curve 2	+	2nd Tone L. Curve 2	→			 Thresh			<table border="1" style="width: 100%; border-collapse: collapse;"> <tr> <td style="width: 50%; text-align: center;">1st Tone L. Curve 2</td> <td style="width: 10%; text-align: center;">+</td> <td style="width: 50%; text-align: center;">2nd Tone L. Curve 3</td> </tr> <tr> <td colspan="3" style="text-align: center;">→</td> </tr> </table>	1st Tone L. Curve 2	+	2nd Tone L. Curve 3	→			 Thresh			
		V-SW	X-FADE	V-MIX																						
<table border="1" style="width: 100%; border-collapse: collapse;"> <tr> <td style="width: 50%; text-align: center;">1st Tone L. Curve 2</td> <td style="width: 10%; text-align: center;">+</td> <td style="width: 50%; text-align: center;">2nd Tone L. Curve 2</td> </tr> <tr> <td colspan="3" style="text-align: center;">→</td> </tr> </table>	1st Tone L. Curve 2	+	2nd Tone L. Curve 2	→			 Thresh																			
1st Tone L. Curve 2	+	2nd Tone L. Curve 2																								
→																										
<table border="1" style="width: 100%; border-collapse: collapse;"> <tr> <td style="width: 50%; text-align: center;">1st Tone L. Curve 2</td> <td style="width: 10%; text-align: center;">+</td> <td style="width: 50%; text-align: center;">2nd Tone L. Curve 3</td> </tr> <tr> <td colspan="3" style="text-align: center;">→</td> </tr> </table>	1st Tone L. Curve 2	+	2nd Tone L. Curve 3	→			 Thresh																			
1st Tone L. Curve 2	+	2nd Tone L. Curve 3																								
→																										

Parameters	Commands
<p>Key Assign (Patch Parameter)</p> <p>[ROT] When the W-30 receives a sequence of Note messages, it plays different voice modules in rotation. (Rotary)</p> <p>[Fix] The W-30 plays the same module only when receiving Note messages of the same key number. In other words, [Fix] plays the next sound without keeping the previous decaying sound, and therefore can be effective for creating the nuance of a percussive roll effect.</p> <p>Uni - Detune (Unison Detune) (Patch Parameter)</p> <p>[-64]-[0]-[63] When the "Uni" (Unison) Key Mode is selected, one of the sounds can be slightly detuned. 50 is roughly half of a semitone.</p> <p>V - SW Thresh (Velocity Switch Threshold) (Patch Parameter)</p> <p>[0]-[127] When the V - SW Key Mode is selected, this determines the threshold level for the two Tones. Higher values require harder playing to sound a different Tone.</p> <p>V - Mix Ratio (Velocity Mix Ratio) (Patch Parameter)</p> <p>[0]-[127] When the Mix Key Mode is selected, the level curve of the 2nd Tone can be changed as shown in the illustration. At zero, the volume obtained is identical to that set for the level curve.</p>	<p>F2 INIT This will initialize the parameters. (see page 184)</p> <p>F1 1patch This will initialize all the parameters of the current Patch, setting them at their default values.</p> <p>F2 1page This will initialize only the parameters shown in the current screen.</p> <p>F3 All This will initialize the parameters of all the Patches from P1 to P16.</p>
	<p>F3 Swap This will exchange the current Patch parameters with those of a different Patch.</p> <p>F1 1patch This will exchange all the parameters of the patch selected under "Patch Swap" with the current Patch.</p>
<p>Out Level (Patch Output Level) (Patch Parameter)</p> <p>[0]-[127] This allows separate settings for the output level of each Patch.</p>	<p>F2 1page This will exchange only those parameters currently shown in the screen, from the Patch selected under "Patch Swap", with the current Patch.</p>
<p>Bend Range (Patch Parameter)</p> <p>[0]-[12] This sets the maximum pitch alteration caused by moving the bender lever to the right or left extremes. Each number represents a semitone; 2 is major 2nd, 3 is minor 3rd, 4 is major 3rd, 7 is perfect 5th and 12 is one octave.</p> <p>*Remember that the pitch cannot exceed the original pitch by more than 2 octaves. Thus, depending on all other settings relative to pitch, in certain cases pitch may not rise upon reception of Bender messages.</p> <p>*If you wish the W-30 to receive Bender and Bend Range messages, set [Bend] and [B.Rng] to [On] in the [33. MIDI RX Set] screen.</p>	

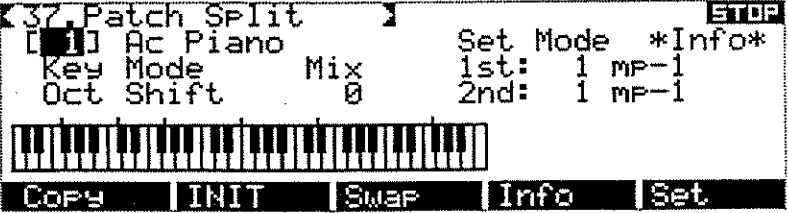
Parameters	Commands
<p>AT Assign (Aftertouch Assign) (Patch Parameter)</p> <p>This selects one of the following five effects to be caused upon reception of Aftertouch Messages.</p> <p>*Aftertouch is the effect obtained on MIDI keyboards featuring the aftertouch function (such as the W-30), by pushing the key harder after playing it in the normal manner.</p> <p>[MOD] (Modulation) Aftertouch controls the vibrato effect.</p> <p>[VOL] (Volume) Aftertouch controls the volume of the sound.</p> <p>[B +] (Bend Up) Aftertouch increases the pitch of the sound.</p> <p>[B -] (Bend Down) Aftertouch lowers the pitch of the sound.</p> <p>*The degree of pitch change obtained by B + and B - is determined by settings for both A.T. Sense and Bend Range.</p> <p>[C - 0] (Cutoff Point) Aftertouch raises the cutoff point of the sound. (This applies only to tones with the TVF Switch parameter set to ON.) (page 160.)</p>	
<p>AT Sense (Aftertouch Sensitivity) (Patch Parameter)</p> <p>[0]-[127] This sets the sensitivity of the aftertouch effect. At 127, the effect is at its maximum.</p>	
<p>Oct. Shift (Octave Shift) (Patch Parameter)</p> <p>[-2],[-1],[0],[1],[2] This can shift the pitch of the entire keyboard from -2 to 2 octaves in 1 octave units. This does not apply when the unit is played by the sequencer or by MIDI messages arriving at MIDI IN.</p>	
<p>Out Assign (Assignment of the Output Sockets) (Patch Parameter)</p> <p>Output can be carried out individually on a Patch or Tone basis from the 8 Multi Output sockets on the W-30.</p> <p>[Out1]-[Out8] The Patch currently in use is sent out from the selected output socket.</p> <p>[Tone] Tones are sent out from the output sockets separately as set with the relevant Tone Parameter in each Tone (page 154). In this mode, the number of voices capable of output is decreased, so certain sounds may be left out.</p>	

Parameters	Commands
 <p>Here Tones are assigned Patches, and key numbers. This is referred to as "Split." This is an *info* display that allows you to monitor how the Tones are assigned to each key. Playing a key will cause the display to show two Tones, the 1st and 2nd Tones, assigned to the corresponding key number at the lower right.</p>  <p>[Patch Number and Name] [1]-[16] Call the Patch to be edited.</p> <p>Key Mode (Patch Parameter) Selects one of the five Key Modes. This can also be set in the [36. Patch Parameter] screen. (page 148.)</p> <p>Oct Shift (Octave Shift) (Patch Parameter) [-2],[-1],[0]. This can shift the pitch of the entire keyboard from - 2 to 2 octaves in 1 octave units. (At 0, C2 to C7 is the range.) By changing this parameter, you can monitor Tone assignment of the C0 to C9 keyboard range or assign Tones.</p> <p>Set Mode To assign Tones to the keyboard, press F5 until the Set Mode is selected. ...</p> <p>[1st & 2nd] 1st and 2nd Tone are reassigned. [1st] Only the 1st Tone is reassigned. [2nd] Only the 2nd Tone is reassigned. [Off] Neither the 1st nor 2nd Tone is assigned. No sound is generated.</p> <p>1st : [1]-[96] Select the 1st Tone to be assigned.</p> <p>2nd : [1]-[96] Select the 2nd Tone to be assigned.</p> <p>Now, playing the keyboard will assign those Tones to the corresponding key number. Be sure to press all the keys to which you wish to assign the Tones.</p>	<p>F1 Copy</p> <p>F1 1patch</p> <p>F2 1page</p> <p>F3 load</p> <p style="margin-left: 20px;">F1 1patch</p> <p style="margin-left: 20px;">F2 1page</p> <p>F2 INIT</p> <p style="margin-left: 20px;">F1 1tone</p> <p style="margin-left: 20px;">F2 1page</p> <p>F3 All</p> <p>F3 Swap</p> <p style="margin-left: 20px;">F1 1patch</p> <p style="margin-left: 20px;">F2 1page</p> <p>These buttons function the same as in the [36. Patch Parameter] screen. See page 148,149 .</p> <p>F5 Set Press this button several times until the desired Set Mode is called.</p>

[38. Patch Param Map]

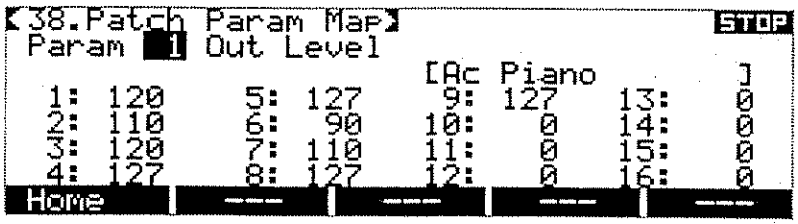
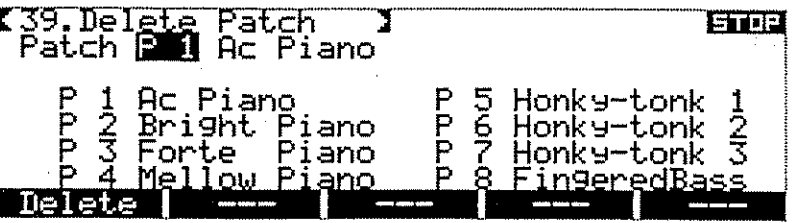
Parameters	Commands
<p>Pressing the F4 button will provide return to the * Info * condition [* Info] This allows you to check the Tone assignments to the keyboard.</p>	<p>F4 Info Press this to return the Set Mode to * Info*.</p>
 <p>This function allows you to individually call each of the Patch parameters and set the values for several Patches.</p> <p>Param (Parameter Name) Call the parameter you wish to edit.</p> <ul style="list-style-type: none"> [1 Out Level] [2 Key Mode] [3 Key Assign] [4 Uni - Detune] [5 V - SW Thresh.] [6 V - Mix Ratio] [7 Bend Range] [8 AT Assign] [9 AT Sense] [10 Out Assign] <p>Move the cursor to the value of the parameter and change it. When the cursor is moved to a Patch, the Patch Name is shown at the upper right of the display.</p>	<p>F1 Home This will return the cursor to the "Param" position.</p>
 <p>This function allows you to initialize the Patch parameters of a Patch and delete Tones assigned to the Patch.</p> <p>*If, however, other Patches are using such Tones, or Sub-tones which are borrowing wave data from those Tones, the Tones will be retained.</p> <p>Patch [Patch Number and Name] [P1]-[P16] Call the patch you wish to delete.</p>	<p>F1 Delete This will execute the Deletion.</p>

Parameters	Commands
<pre> 41. Tone Parameter STOP [1] MP-1 A0.8 Orig. Tone ** P.LFO Depth 0 Orig. Key B 2 P.Bender On P.Follow On After Touch On P.Shift 0 Out Assign Out1 Fine Tune 11 Out Level 117 Copy INIT Swap --- T.List </pre>	<p>F1 Copy This will copy the parameter settings.</p> <p>F1 1tone This will copy all the parameters of the tone selected in "Copy from" to the current Tone.</p>
<p>This screen allows you to set the most important Tone parameters.</p>	<p>F2 1page This will copy those parameters shown in the screen from the Tone selected in "Copy from" to the current Tone.</p>
<p>(NOTE) If the Out Level of the Patch selected in the [36. Patch Parameter] screen is set to 0, the volume in the [41. Tone Parameter] screen is also set to 0, thereby the Tone will not be heard.</p>	<p>F3 load This will copy the Tone parameters from a disk. (page 73, 75)</p>
<p>[Tone Number] and Tone Name (Tone Parameter) [1]-[96] Call the Tone to be edited. Each Tone can be named using up to 8 characters. (Distinguishing Tone Types, see page 68.)</p>	<p>(To copy to Tones 1-32) → This allows you to copy only from data disks.</p> <p>(To copy to Tones 33-96) → This allows you to copy from data disks and the system disk.</p>
<p>Orig. Tone (Original Tone) (Tone Parameter) Call a Sub-tone (indicated as Sub) with [Tone Number], then here select the Original Tone from which wave data is to be borrowed to make a Sub-tone.</p> <p>[1]-[32] Select the Original Tone from which wave data is to be borrowed. When an Original Tone is selected, parameters that are involved with looping are copied.</p> <p>[--] If a Sub-tone is selected, [--] is shown and no sound is heard.</p> <p>[**] This appears when an Original Tone is called. An Original Tone already has its own wave data, and thus cannot borrow waveforms from another Tone.</p>	<p>F1 1tone This will copy all the parameters of the "Copy from disk" (source) Tone to the current Tone. *The ROM Wave A/B is also recognized.</p>
<p>Orig. Key (Original Key Number) (Tone Parameter) [C0]-[C8] This edits the original key number of a sample (page 181). Playing the key selected here will make sound at the pitch of the sample. Middle C is represented by C4, and a semitone by #.</p> <p>*The W-30 can play up to a pitch that is two octaves higher than the pitch of the sampled sound. Any pitch that exceeds that does not sound.</p>	<p>F2 1page This will copy only those parameters shown in the display from the "Copy from disk" (source) Tone to the current Tone. *The ROM Wave A/B is not recognized.</p>
<p>P. Follow (Pitch Follow) (Tone Parameter) [On] This is the normal mode. Different pitches are played by different keys. [Off] The pitch of the Original Key will sound whatever key is played.</p>	

[41. Tone Parameter]

Parameters	Commands
<p>P. Shift (Shift) (Tone Parameter) [-24]-[+24] This sets the pitch when the Pitch Follow is set to [Off]. At [0], the original pitch of the sampled sound is obtained. At [+1], the pitch is a semi-tone higher than the Original Key, and at [-1], a semitone lower.</p>	<p>F2 INIT This will initialize the parameters. (page 184.)</p>
<p>Fine Tune (Tone Parameter) [-64]-[0]-[63] This minutely adjusts the pitch of the Tone. ± 50 is about half a semitone.</p>	<p>F1 1tone This will initialize all the parameters of the currently selected Tone.</p>
<p>Out Level (Tone Level) (Tone Parameter) [0]-[127] This adjusts the volume of each Tone.</p>	<p>F2 1page This will initialize only the parameters shown in the screen, for the currently selected Tone.</p>
<p>P.LFO Depth (LFO Depth of Pitch Modulation) (Tone Parameter) [0]-[127] This sets the depth of the LFO that controls the pitch modulation. The LFO parameters are set in the [43. LFO] screen.</p>	<p>F5 Delete This will initialize all the parameters of the Tone currently shown in the screen, and delete the wave data.</p>
<p>P.Bender (Pitch Bender On/Off) (Tone Parameter) [On] The pitch of the Tone changes in accord with the Bend Range set for the Patch. [Off] The pitch is not affected by Bender messages.</p>	<p>F3 Swap This will exchange the current Tone parameters with those of a different Tone.</p>
<p>After Touch (Aftertouch On/Off) (Tone Parameter) [On] Aftertouch effects are obtained in keeping with the settings for Aftertouch Sense and Aftertouch Assign set for the Patch. [Off] The Tone is not affected by receiving aftertouch messages.</p>	<p>F1 1tone This will exchange all the parameters of the Tone selected in "Tone Swap" with the current Tone.</p>
<p>Out Assign (Assigning Tones to Output Sockets) (Tone Parameter) [Out1]-[Out8] Tones are output from the output sockets assigned in parameter when the Out Assign of the Patch is set to Tone (see page 150.)</p>	<p>F2 1page This will exchange those parameters appearing in the screen, from the Tone selected in "Tone Swap", with the current Tone.</p>
	<p>F5 T. List This will display Tone Lists for T1 to T96. Selecting different Tone numbers moves the display onwards through the relevant Tone Lists.</p>

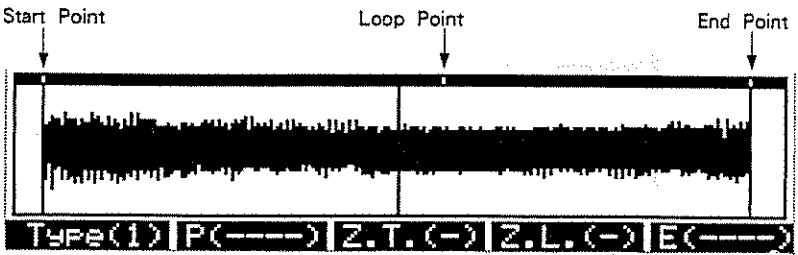
Parameters	Commands
<p>Loop Tune <Tone Parameter> [-64]-[0]-[63] Before entering a loop and after leaving the loop, the pitch may differ. If so, use Loop Tune to adjust it.</p> <p>Start Point <Tone Parameter> Loop Point <Tone Parameter> End Point <Tone Parameter> [Address] The points are represented by their positions in memory. This is called the Address. The beginning of the wave data is address 0. (page 71.)</p> <p>Search Mode This selects how the address actually changes by rotating the dial: [± 1] Address changes in single steps. [± 114] Address changes in steps of 114. [Peak] The W-30 searches for the peaks of waves (point where the wave starts increasing or decreasing), advancing from one peak to another. This is called "Peak Search".</p> <p>Loop Edit This selects one of the two methods of loop setting.</p> <p>[Point] (Editing Loop Point) The Loop point and the End point can be set separately.</p> <p>[Length] (Editing Loop Length) Moving the End point changes the Loop point together with the End point, but the Loop length is not affected. This is useful for changing the area in the wave for looping in the Forward Loop mode. (Moving the Loop point will change the Loop Length without moving the End point.)</p> <p>F5 Graphic The waveform of the selected Tone is displayed. With Sub-tones, their Original Tone's waveform is displayed. Three different screens are provided; for observing the Start, Loop and End points.</p> <p>Type () (Selecting a Screen Type) [1] The entire shape of the waveform can be seen in this screen. Whether the wave is long or short, data for the entire wave is shown, so it takes up the whole display.</p> <div style="text-align: center;"> <p>Start Point Loop Point End Point</p>  </div>	<p>F4 Auto This will turn the W-30 to the Auto mode, which has the internal computer find out the Loop point and the End point for Forward looping. This is called Auto Looping. The Auto Loop function can search for new Loop points and End points between the Loop point and the End point currently set.</p> <p>F1 L→E This mode searches through the loop from the Loop point to the End point.</p> <p>F2 L←E This mode searches through the loop from the End point to the Loop point.</p> <p>*The Auto Loop may not be able to find a loop depending on the setting of the loop. It may be a good idea to loop fairly long, and try with a variety of different settings. *Auto Loop searches only for a [Forward] loop, therefore, executing the Auto Loop automatically turns the Loop Mode to [Forward].</p> <p>F2 INIT F1 1tone F2 1page F5 Delete</p> <p>F3 Swap F1 1tone F2 1page</p> <p>The above buttons function the same as in the [41. Tone Parameter] screen. See page 154.</p>

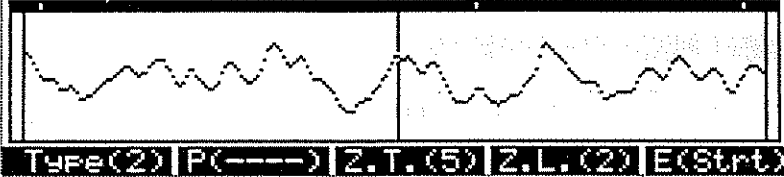
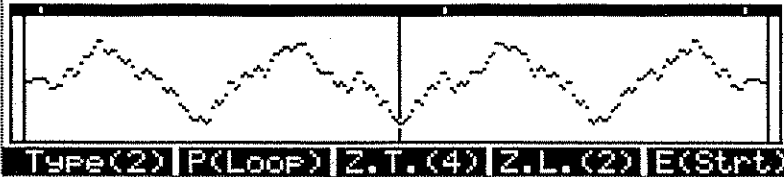
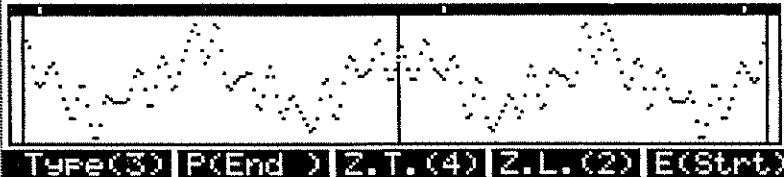
Parameters	Commands
<p>[2] When the Loop Mode is set to Forward, the left side of the center line shows the waveform up to the End point, and the right side shows the waveform from the Loop point. By connecting waves deftly on this line, a natural sustained sound can be obtained.</p>  <p>In the Loop Mode "Alter", when you press F2 to set to "P (Loop)" (the center line is the Loop point), you can see the waveform turned back at the Loop point. If you press F2 to set to "P (End)" (the center line is the End point), the waveform is turned back at the End point. By connecting waves without spoiling the wave's smooth flow, a natural sustained sound can be obtained.</p> 	<p>F2 P () When Screen Type 2 (Alter) or 3 is selected, pressing this button changes the point symbolized by the center line.</p> <p>F3 Z.T.() When Screen Type 2 or 3 is selected, the wave display is enlarged or reduced, in 5 stages, along the axis of time.</p> <p>F4 Z.L.() When Screen Type 2 or 3 is selected, the wave display is enlarged or reduced, in 5 stages, along the axis of Level.</p>
<p>[3] Each of the 3 points can be seen in detail.</p> <p>Press F2 to set to "P (strt)", and the center line becomes the Start point.</p> <p>Press F2 to set to "P (Loop)", and the center line becomes the Loop point.</p> <p>Press F2 to set to "P (End)", and the center line becomes the End point.</p> 	<p>F5 E () Each time you press this, it provides change of the points - Start, Loop, and End Points selected can be changed by the Value dial. The Value dial functions in accord with settings made for the search mode.</p>

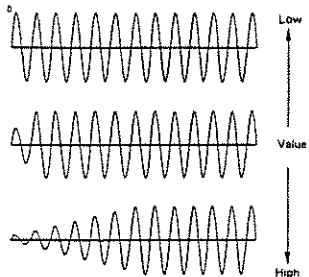
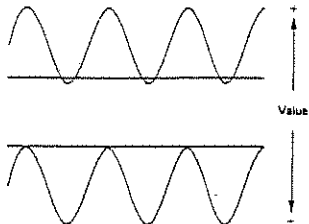
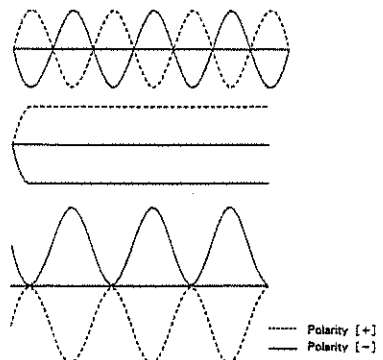

Parameters	Commands
<div style="border: 1px solid black; padding: 5px; margin-bottom: 10px;"> <pre> 43. LFO [1] MP-1 A0.8 Rate 88 Delay 0 Sync On Offset 0 Mode Sin Polarity + </pre> <div style="display: flex; justify-content: space-around; border-top: 1px solid black; padding-top: 5px;"> COPY INIT SWAP --- --- </div> </div> <p>The LFO controls TVF and TVA, along with generating pitch modulation (page 62).</p> <p>(NOTE) If the Out Level of the Patch selected in the [36. Patch Parameter] screen is set to 0, the volume in this screen is also set to 0, therefore the Tone cannot be heard.</p> <p>[Tone Number] [1]-[96] Call the Tone to be edited. (Distinguishing Tone Types, see page 68.)</p> <p>Rate (LFO Rate) (Tone Parameter) [0]-[127] This sets the speed of the LFO modulation. Higher values increase the speed.</p> <div style="text-align: center;"> </div> <p>Sync (LFO Sync) (Tone Parameter) [On] The LFO modulation starts at zero phase. [Off] The phase of modulation is not defined.</p> <div style="text-align: center;"> </div> <p>Mode (LFO Mode) (Tone Parameter) [Sin] (Sine) Waveform of the LFO modulation is a sine wave. [P.H] (Peak Hold) When the LFO wave reaches its peak, it is sustained.</p> <div style="text-align: center;"> </div>	<div style="margin-bottom: 10px;"> <p>F1 Copy</p> <ul style="list-style-type: none"> F1 1tone F2 1page F3 load <ul style="list-style-type: none"> F1 1tone F2 1page </div> <div style="margin-bottom: 10px;"> <p>F2 INIT</p> <ul style="list-style-type: none"> F1 1tone F2 1page F5 Delete </div> <div style="margin-bottom: 10px;"> <p>F3 Swap</p> <ul style="list-style-type: none"> F1 1tone F2 1page </div> <p>The above buttons function the same as in the [41. Tone Parameter] screen. See page 153, 154.</p>

Parameters	Commands
<p>Delay (LFO Delay) (Tone Parameter) [0]-[127] This can gradually increase the width of the LFO wave. Higher values make the time needed for the wave to reach the set depth longer.</p>  <p>Offset (Tone Parameter) [-64]-[0]-[+63] The LFO wave can be moved up or down.</p>  <p>Polarity (Tone Parameter) [+] The wave is produced as is set. [-] The wave is reversed.</p>  <p>*LFO Depth can be set individually for each Pitch Modulation (page 154), [44. TVF Page 1] (page 161) and [46. TVA Page 1] (page 161).</p>	

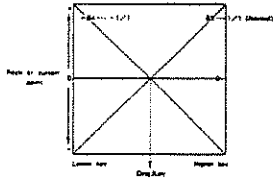
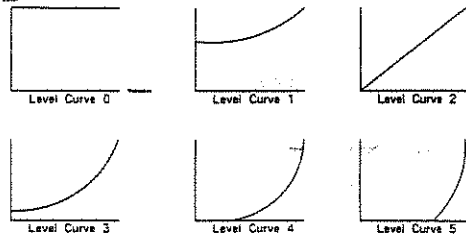
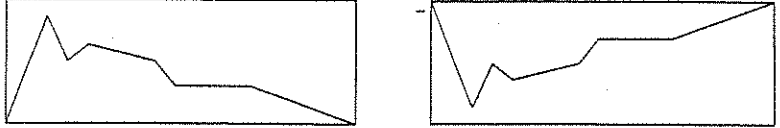
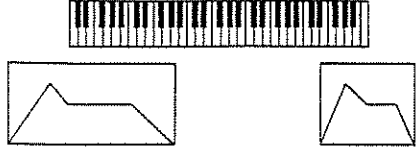
Parameters	Commands
<div style="border: 1px solid black; padding: 5px; margin-bottom: 10px;"> <p>44. TVF Page 1 STOP</p> <p>[1] MP-1 A0.8</p> <p>TVF Switch On L. Curve 2</p> <p>Cut-off 35 EG Depth 127</p> <p>Resonance 5 EG Pol. +</p> <p>Key Follow -41 Key-Rate 64</p> <p>LEO Depth 0 Vel-Rate 57</p> <p style="text-align: center;">COPY INIT SWAP --- Page</p> </div> <p>The TVF determines the depth and the time of the effect obtained in the digital Lowpass filter.</p> <p>(NOTE) If the Out Level of the Patch selected in the [36. Patch Parameter] screen is set to 0, the volume in this screen is also set to 0, therefore the Tone cannot be heard.</p> <p>[Tone Number] [1]-[96] Call the Tone to be edited. (Distinguishing Tone Types, see page 68.)</p> <p>TVF Switch (TVF ON/OFF) (Tone Parameter) TVF (Time Variant Filter) controls the cutoff of the digital filter.</p> <p>[On] TVF is turned on. [Off] TVF is turned off.</p> <p>Cut-off (Cutoff Frequency) (Tone Parameter) [0]-[127] This sets the basic cutoff point of the TVF. As you lower the value, higher frequencies are removed and the waveform gradually becomes an approximation of a sine wave.</p> <p style="text-align: center;">* If set too low, sound might not be produced.</p> <div style="text-align: center;"> </div> <p>Resonance (Tone Parameter) [0]-[127] This boosts the cutoff point. As you increase the value, specific harmonics are emphasized and the sound will become more unusual, more electronic in nature.</p> <div style="text-align: center;"> </div>	<p>F1 Copy</p> <p>F1 1tone</p> <p>F2 1page</p> <p>F3 load</p> <p style="margin-left: 20px;">F1 1tone</p> <p style="margin-left: 20px;">F2 1page</p> <p>F2 INIT</p> <p style="margin-left: 20px;">F1 1tone</p> <p style="margin-left: 20px;">F2 1page</p> <p style="margin-left: 20px;">F5 Delete</p> <p>F3 Swap</p> <p style="margin-left: 20px;">F1 1tone</p> <p style="margin-left: 20px;">F2 1page</p> <p>The above buttons function the same as in the [41. Tone Parameter] screen. See page 153, 154.</p>

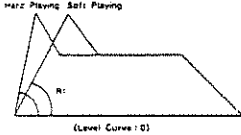
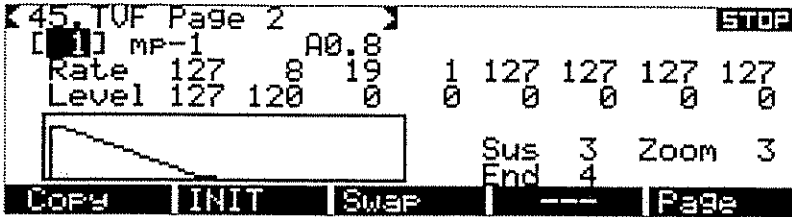
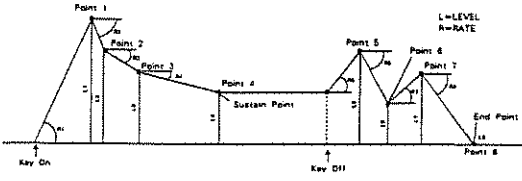
Parameters	Commands
<p>Key Follow (of Cutoff Point) (Tone Parameter) [-64]-[0]-[63] Key Follow can change the cutoff point depending on the key played, based on the pitch of the Original key.</p> 	
<p>LFO Depth (of TVF) (Tone Parameter) [0]-[127] If you wish to modulate cutoff frequencies by using the LFO, set the depth of LFO here. How the cutoff frequency actually changes is determined in [43. LFO].</p>	
<p>L. Curve (Level Curve) (Tone Parameter) [0]-[5] This curve controls the cutoff point of the envelope respective to keyboard playing strength. At 0, the cutoff point of the envelope is not affected by the way you play the keyboard.</p> 	
<p>EG Depth (TVF EG Depth) (Tone Parameter) [0]-[127] This determines the depth of the envelope control on the cutoff point. Higher values provide more depth.</p>	
<p>EG Pol.(TVF EG Polarity) (Tone Parameter) [+] Envelope is generated as it is set. [-] Envelope curve is reversed.</p>	
	
<p>Key - Rate (Tone Parameter) [0]-[127] This can change the curve of the envelope depending on which key is played. Higher keys make a steeper curve, and lower keys a gentler curve.</p> 	

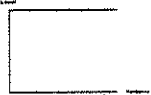
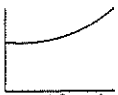
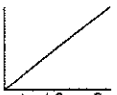
Parameters	Commands
<p>Vel - Rate (Velocity Rate) (Tone Parameter) [0]-[127] This can change R1 (rate 1) of the envelope curve. The curve becomes steeper with harder playing, and with softer playing styles, the curve is gentler. The higher the value, the higher the ratio of difference becomes.</p> <div style="text-align: center;">  </div>	
<p>F5 Page This switches you to [44. TVF Page 2].</p> <div style="border: 1px solid black; padding: 5px; margin: 10px 0;"> <p>45. TVF Page 2 STOP</p> <p>[1] MP-1 A0.8</p> <p>Rate 127 8 19 1 127 127 127 127</p> <p>Level 127 120 0 0 0 0 0 0</p> <div style="display: flex; justify-content: space-between; align-items: center;">  <div style="text-align: right;"> <p>Sus 3 Zoom 3</p> <p>End 4</p> </div> </div> <p>Copy INIT Swap --- Page</p> </div> <p>Up to eight break points can be set for making an envelope curve that controls the cutoff point of the Lowpass filter. The position of each break point is set in terms of Level and Rate.</p> <div style="text-align: center;">  </div> <p>Rate (Tone Parameter) [1]-[127] This is a slide from one break point to the next one. Higher values make steeper slopes.</p> <p>Level (Tone Parameter) [0]-[127] This sets the cutoff point of a break point.</p> <p>Sus (Sustain Point) (Tone Parameter) [1]-[7] This sets the cutoff point to be sustained until the key is released. *It is not possible to set this after the end point.</p> <p>End (End Point) (Tone Parameter) [2]-[8] This is the end of the curve. The level of End point is 0. *It is not possible to set this before the sustain point.</p> <p>Zoom (Tone Parameter) [1]-[5] This can enlarge or reduce the envelope display along the axis of time.</p> <p>Pressing F5 at this stage will recall the previous screen.</p>	

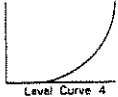
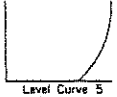
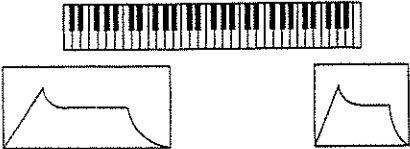
Parameters	Commands
<div style="border: 1px solid black; padding: 5px; margin-bottom: 10px;"> <p style="text-align: center;">46. TVA Page 1 STOP</p> <p>[1] MF-1 A0.8</p> <p>LFO Depth 0</p> <p>L. Curve 2</p> <p>Key-Rate 64</p> <p>Vel-Rate 34</p> <p style="text-align: center;">COPY INIT SWAP --- Page</p> </div> <p>The TVA contains various elements that control the volume.</p> <p>(NOTE) If the Out Level of the Patch selected in the [36. Patch Parameter] screen is set to 0, the volume in this screen is also set to 0, therefore the Tone cannot be heard.</p> <p>[Tone Number]</p> <p>[1]-[96] Call the Tone to be edited. (Distinguishing Tone Types, see page 68.)</p> <p>LFO Depth (of TVA) (Tone Parameter)</p> <p>[0]-[127] If you wish to modulate volume by using the LFO, set the depth of LFO here. How the volume actually changes is determined in [43. LFO].</p> <p>L. Curve (Level Curve) (Tone Parameter)</p> <p>[0]-[5] This curve controls the volume of the envelope respective to the style the keyboard is played. At 0, the volume of the envelope is not affected by the way you play the keyboard.</p> <div style="display: flex; justify-content: space-around; margin: 10px 0;"> <div style="text-align: center;">  <p>Level Curve 0</p> </div> <div style="text-align: center;">  <p>Level Curve 1</p> </div> <div style="text-align: center;">  <p>Level Curve 2</p> </div> </div> <div style="display: flex; justify-content: space-around; margin: 10px 0;"> <div style="text-align: center;">  <p>Level Curve 3</p> </div> <div style="text-align: center;">  <p>Level Curve 4</p> </div> <div style="text-align: center;">  <p>Level Curve 5</p> </div> </div> <p>Key - Rate (Tone Parameter)</p> <p>[0]-[127] This can change the curve of the envelope depending on which key is played. Higher keys make a steeper curve, and lower keys a gentler curve.</p> <div style="text-align: center; margin-top: 20px;">  </div>	<ul style="list-style-type: none"> F1 Copy <li style="margin-left: 20px;">F1 1tone <li style="margin-left: 20px;">F2 1page <li style="margin-left: 20px;">F3 load <li style="margin-left: 40px;">F1 1tone <li style="margin-left: 40px;">F2 1page <li style="margin-left: 20px;">F2 INIT <li style="margin-left: 40px;">F1 1tone <li style="margin-left: 40px;">F2 1page <li style="margin-left: 40px;">F5 Delete <li style="margin-left: 20px;">F3 Swap <li style="margin-left: 40px;">F1 1tone <li style="margin-left: 40px;">F2 1page <p>The above buttons function the same as in the [41. Tone Parameter] screen. See page 153, 154.</p>

Parameters	Commands
------------	----------

Vel - Rate (Velocity Rate) (Tone Parameter)
 [0]-[127] This can change the angle (R1) of the envelope curve. With higher keys, the curve becomes steeper by harder playing, and with lower values, the curve is gentler.

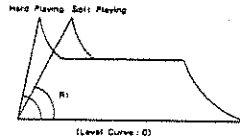

F5 Page

This will turn you to [46. TVA Page 2].

```

47. TVA Page 2
[1] MP-1 A0.8
Rate 127 51 43 81 127 127 127 127
Level 127 54 0 0 0 0 0 0
Sus 3 Zoom 3
End 4
COPY INIT SWAP --- Page
    
```

By setting the Break points of an envelope curve, wave data can be read (played back) at different volumes. For instance, the attack of a sound can be purposely delayed, or a decaying effect can be added to a loop. However, the volume of the sampled sound is the maximum, therefore, it is not possible to make the attack quicker than the sampled waveform, or increase the volume, or sustain a one-shot sound.

Up to eight break points (rates and levels) can be set for making an envelope curve.

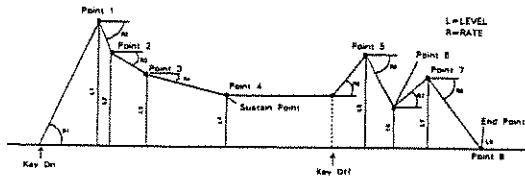

Rate (Tone Parameter)

[1]-[127] This is a slide from one break point to the next one. Higher values make steeper slopes.

Level (Tone Parameter)

[0]-[127] This sets the volume of a break point.

Sus (Sustain Point) (Tone Parameter)

[1]-[7] This sets the volume to be sustained until the key is released.

*It is not possible to set this after the end point.

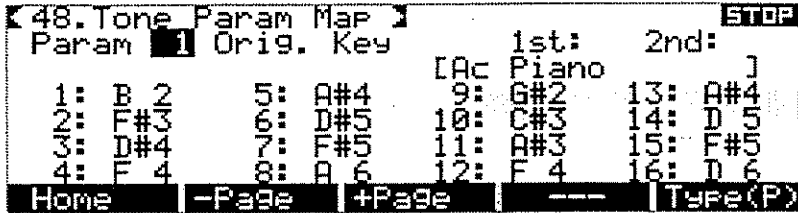
Parameters	Commands																														
<p>End (End Point) (Tone Parameter) [2]-[8] This sets how many break points are to be used. The Level of the End point is always 0. Any value other than 0 cannot be entered.</p> <p>*It is not possible to set this before the sustain point.</p> <p>*The Rate before the Sustain point and End point actually draws an exponential curve.</p> <p>Zoom (Tone Parameter) [1]-[5] This enlarges or reduces the envelope display along the axis of time.</p> <p>Pressing F5 at this stage will recall the previous screen [46. TVA Page 1].</p>																															
 <p>This function allows you to call each one of the Tone parameters and set the values of several Tones.</p> <p>(NOTE) If the Out Level of the Patch selected in the [36. Patch Parameter] screen is set to 0, the volume in this screen is also set to 0, therefore the Tone cannot be heard.</p> <p>Param (Parameter Name) Call the parameter you wish to edit.</p> <table border="0"> <tr> <td>[1 Orig. Key]</td> <td>[15 LFO Polarity]</td> </tr> <tr> <td>[2 P. Follow]</td> <td>[16 TVF Switch]</td> </tr> <tr> <td>[3 P. Shift]</td> <td>[17 TVF Cut - off]</td> </tr> <tr> <td>[4 Fine Tune]</td> <td>[18 TVF Resonance]</td> </tr> <tr> <td>[5 P. LFO Depth]</td> <td>[19 TVF Key Follow]</td> </tr> <tr> <td>[6 P. Bender]</td> <td>[20 TVF LFO Depth]</td> </tr> <tr> <td>[7 After Touch]</td> <td>[21 TVF L. Curve]</td> </tr> <tr> <td>[8 Out Assign]</td> <td>[22 TVF EG Depth]</td> </tr> <tr> <td>[9 Out Level]</td> <td>[23 TVF EG Pol.]</td> </tr> <tr> <td>[10 LFO Rate]</td> <td>[24 TVF Key - Rate]</td> </tr> <tr> <td>[11 LFO Sync]</td> <td>[25 TVF Vel - Rate]</td> </tr> <tr> <td>[12 LFO Mode]</td> <td>[26 TVA LFO Depth]</td> </tr> <tr> <td>[13 LFO Delay]</td> <td>[27 TVA L. Curve]</td> </tr> <tr> <td>[14 LFO Offset]</td> <td>[28 TVA Key - Rate]</td> </tr> <tr> <td></td> <td>[29 TVA Vel - Rate]</td> </tr> </table>	[1 Orig. Key]	[15 LFO Polarity]	[2 P. Follow]	[16 TVF Switch]	[3 P. Shift]	[17 TVF Cut - off]	[4 Fine Tune]	[18 TVF Resonance]	[5 P. LFO Depth]	[19 TVF Key Follow]	[6 P. Bender]	[20 TVF LFO Depth]	[7 After Touch]	[21 TVF L. Curve]	[8 Out Assign]	[22 TVF EG Depth]	[9 Out Level]	[23 TVF EG Pol.]	[10 LFO Rate]	[24 TVF Key - Rate]	[11 LFO Sync]	[25 TVF Vel - Rate]	[12 LFO Mode]	[26 TVA LFO Depth]	[13 LFO Delay]	[27 TVA L. Curve]	[14 LFO Offset]	[28 TVA Key - Rate]		[29 TVA Vel - Rate]	<p>F1 Home This will return the cursor to the "Param" position.</p> <p>F2 - Page F3 + Page These are used to change the Tone List.</p>
[1 Orig. Key]	[15 LFO Polarity]																														
[2 P. Follow]	[16 TVF Switch]																														
[3 P. Shift]	[17 TVF Cut - off]																														
[4 Fine Tune]	[18 TVF Resonance]																														
[5 P. LFO Depth]	[19 TVF Key Follow]																														
[6 P. Bender]	[20 TVF LFO Depth]																														
[7 After Touch]	[21 TVF L. Curve]																														
[8 Out Assign]	[22 TVF EG Depth]																														
[9 Out Level]	[23 TVF EG Pol.]																														
[10 LFO Rate]	[24 TVF Key - Rate]																														
[11 LFO Sync]	[25 TVF Vel - Rate]																														
[12 LFO Mode]	[26 TVA LFO Depth]																														
[13 LFO Delay]	[27 TVA L. Curve]																														
[14 LFO Offset]	[28 TVA Key - Rate]																														
	[29 TVA Vel - Rate]																														

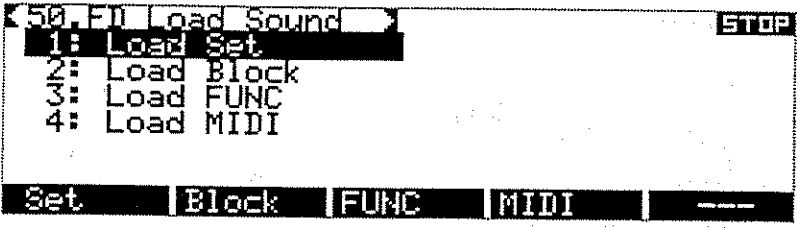
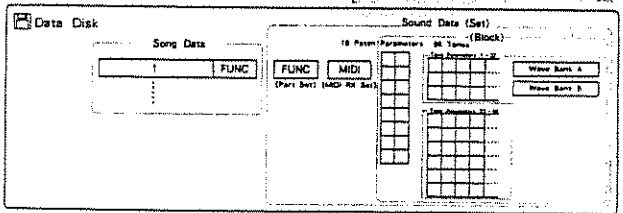
Parameters	Commands
<p>Move the cursor to the Tone to be edited. When the cursor is moved to a Tone, the Tone Name is shown at the upper right of the display.</p> <p>Patch Play and Tone Play</p> <p>Patch Play mode (P) allows you to play the Patch currently called in the [36. Patch Parameter] screen, along with editing its tones.</p> <p>When a key is played, the 1st and 2nd Tones assigned to the key are shown at the upper right of the display.</p> <p>Tone Play mode (T) allows you to actually play the Tone indicated by the cursor, and edit it.</p>	<p>F5 Type ()</p> <p>(P) type is the Patch Play and (T) type is the Tone Play mode. (page 35.)</p>
 <p>This allows you to load sound data from a disk.</p>  <p>1 : Load Set All sound data on a disk is loaded.</p> <p>2 : Load Block Sound data except for FUNC parameters and MIDI parameters is loaded.</p> <p>3 : Load FUNC Func parameters are loaded.</p> <p>4 : Load MIDI MIDI parameters are loaded.</p> <p>*In addition to W-30 sound and song disks, sound disks for the S-550 or S-330 can be used as well. However, in such cases, Tone [T11] of the S-550 and S-330 corresponds to Tone [1] on the W-30, and [T48] corresponds to [32]. Because the specifications of the W-30, S-550 and S-330 are different, the resulting sounds on each unit may differ somewhat (page 100).</p>	<p>F1 Set This will execute Load Set.</p> <p>F2 Block This will execute Load Block.</p> <p>F3 FUNC This will execute Load FUNC.</p> <p>F4 MIDI This will execute Load MIDI.</p>

Parameters	Commands
<div data-bbox="244 327 1037 544"> <pre> 51. FD Save Sound STOP 1: Save Set 2: Save Block 3: Save FUNC 4: Save MIDI 5: Sound Memo Set Set Block FUNC MIDI Memo </pre> </div> <p>This function allows you to save sound data onto a disk.</p> <p>1 : Save Set All sound data is saved.</p> <p>2 : Save Block Sound data except for FUNC parameters and MIDI parameters is saved.</p> <p>3 : Save FUNC Func parameters are saved.</p> <p>4 : Save MIDI MIDI parameters are saved.</p> <p>5 : Sound Memo Set Allows attaching a memo to the sound</p> <p>*In addition to W-30 sound and song disks, sound disks for the S-550 or S-330 can also be used. Since in the S-550 Block, and with the S-330 there are 32 Tones, [T11] - [T48], [T33] through [96] on the W-30 are ignored. Moreover, any keys that are Split respective to tones [33] to [96] will lose their assignment (are OFF).</p> <p>Because the W-30's, S-550's and S-330's processing methods are different, the resulting sounds on each unit may differ (page 101).</p>	<div data-bbox="1103 400 1400 940"> <p>F1 Set This will execute Save Set.</p> <p>F2 Block This will execute Save Block.</p> <p>F3 FUNC This will execute Save FUNC.</p> <p>F4 MIDI This will execute Save MIDI.</p> <p>F5 Memo This allows creation of a Sound Memo (up to 60 characters) that is saved along with sound</p> </div>
<div data-bbox="244 1081 1037 1298"> <pre> 52. FD Load Patch STOP Insert Sound/System Disk and press 'F1:Execute' Execute --- --- --- --- </pre> </div> <p>This allows you to load a Patch from a disk. Patch data loaded includes Patch parameters and Tones (Tone parameters and wave data) assigned to the Patch (page 74,76).</p> <p>When the message "Insert Sound/System Disk and press 'F1: Execute'" appears, insert a data disk containing sound data or system disk, then press F1.</p> <div data-bbox="244 1493 1037 1710"> <pre> 52. FD Load Patch STOP Remaining Time A-7.2s B-7.2s Free Tone [1-32] 32 [33-96] 0 Destination [1] Ac Piano Disk [1] Drums/Perc Load Check --- Del P Del T </pre> </div> <p>Destination (Destination Patch Number)</p> <p>[1]-[16] This select the Patch number where the source Patch is to be loaded.</p> <p>Disk (Patch to be loaded)</p> <p>[1]-[16] : when using a sound disk</p> <p>[1]-[32] : when using a system disk</p> <p> Select the source Patch to be loaded.</p>	<div data-bbox="1103 1144 1400 1642"> <p>F1 Load This will execute Load Patch.</p> <p>F4 Del P Whenever there are not enough unused Tones, or the remaining memory in a Wave bank is not sufficient, delete unneeded Patches using Del P. The Patch selected at "Destination" is deleted.</p> <p>This function will initialize Patch parameters of the Patch and delete Tones (Tone parameters, Wave data) assigned to the Patch. (page 152.)</p> </div>

Parameters	Commands
<p>F2 Check</p> <p>This function allows you to check the Tones used in the Patch to be loaded.</p> <p>[1-32] [33-96] The number of Tones used in the Patch being loaded (Disk) is displayed.</p> <p>Time The combined length of waves used in the Tones. [1] - [32], that are used in the Patch (Disk) being loaded, is displayed in terms of a 30kHz sampling frequency.</p> <p>Tone data is loaded to the empty regions of memory, thus retaining any existing internal Tone data. (Tones used by the destination Patch are not deleted.)</p> <p>Regarding Tone Numbers: of tones being used by the patch (Disk) being loaded; they are loaded in order starting from the lowest numbered one. Internally, they are placed at Tone Numbers, starting with the lowest one that is unused. When load is executed, loading takes place in order, beginning with the tone having the longest wave. Tone numbers assigned to the Patch are automatically rewritten, therefore you do not need to change the Split (Tone assignment). When loading has finished, "Complete" is displayed.</p> <ul style="list-style-type: none"> ●When the number of unused tones available internally is not sufficient to cover the number of tones used in the patch to be loaded, "Can't Execute" is displayed and the process cannot be carried out. Use F4 (Del P) or F5 (Del T) to delete tones first. ●When the remaining space in the internal wave bank is not sufficient for the wave data to be loaded. When there is no more space left in the wave bank, the message "Out of Memory" appears and the loading stops there, showing the tones which are not loaded. To load those tones, use F4 (Del P) to delete the patch just loaded, then use F5 (Del T) to delete unneeded tones. Then try loading once again. ●To load Sub-tones When the Original Tone that the Sub-tone borrows the wave data from is used in the same Patch, it will automatically become a Sub-tone. When the Original Tone is not used in the same Patch, the Sub-tone will automatically load wave data of the Original Tone and it becomes an Original Tone. 	<p>F5 Del T</p> <p>Whenever the number of unused Tones, or remaining memory in a Wave bank is not sufficient, delete unneeded Tones using this function</p> <p>F1 1tone</p> <p>This will delete the Tone selected at [].</p> <p>F2 Bank - A</p> <p>This will delete all Tones that use the wave in Wave Bank A.</p> <p>F3 Bank - B</p> <p>This will delete all Tones that use the wave in Wave Bank B.</p> <p>F4 ROM All</p> <p>Tones [33] - [96] take on an unused status, and thus do not sound.</p>
<p>53. FD Load Tone STOP</p> <p>Remaining Time A-0.0s B-0.0s</p> <p>Destination [1] MP-1 A0.8</p> <p>== Disk =====</p> <p>Source [1] MP-1 A0.8</p> <p> MP-2 A0.8</p> <p> MP-3 A0.8</p> <p>Load-A Load-B Delete --- Graphic</p> <p>This function allows you to load Tones (Wave data and Tone parameters) from a disk.</p>	<p>F1 Load - A</p> <p>This will execute loading. Wave data is written to Wave Bank A.</p> <p>F2 Load - B</p> <p>This will execute loading. Wave data is written to Wave Bank B.</p>

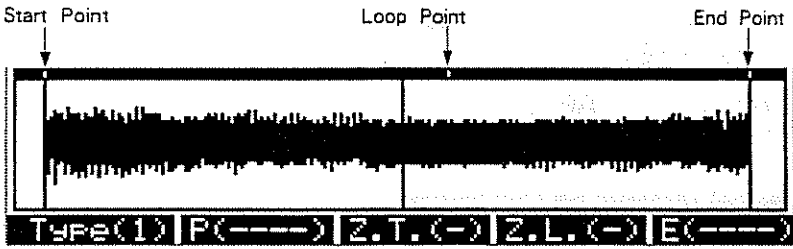
Parameters	Commands
<p>When you load a Sub-tone, the wave data used in the Sub-tone is loaded and it becomes an Original Tone.</p> <p>The Load Tone function cannot be used for the system disk. Also, tones 33 to 96 on a data disk cannot be loaded. When you wish to load them, select the tone, [33] - [96] in a tone editing screen, such as [41. Tone Parameter], then perform: F1 Copy → F3 Load → F1 1 tone. (page 73,75.)</p> <p>Destination (Destination Tone Number) [1]-[32] Specify the Tone number where the source Tone is to be loaded. (See page 68 "Times when new Wave data is created".)</p> <p>=== Disk === Source (Tone to be loaded) [1]-[32] Specify the Tone to be loaded. (Distinguishing Tone Types, see page 68.)</p> <p>When there is no space left for writing in the destination Wave Bank, "Can't Execute" is shown when you try to execute loading, and the process cannot be performed. Be aware that when remaining space is insufficient, the excess will be ignored, therefore some Wave data may be cut off.</p>	<p>F3 Delete Whenever the memory in a Wave bank is not sufficient, delete unneeded Tones using this function.</p> <p>F1 1tone This will delete the Tone selected at [].</p> <p>F2 Bank - A This will delete all Tones that use the wave in Wave Bank A.</p> <p>F3 Bank - B This will delete all Tones that use the wave in Wave Bank B.</p> <p>F4 ROM All Tones [33] - [96] take on an unused status, and thus do not sound.</p>
<p>F5 Graphic</p> <p>* This is the waveform display of the Destination Tone. When a Sub-tone is selected, the waveform of the Original Tone from which the Sub-tone borrows wave data is shown.</p> 	<p>F1 Type () This selects a Screen Type; 1, 2 or 3.</p> <p>F2 P () When Screen Type 2 or 3 is selected, this will change the point indicated by the center line.</p> <p>F3 Z.T.() When Screen Type 2 or 3 is selected, this will enlarge or reduce the wave along the axis of Time.</p> <p>F4 Z.L.() When Screen Type 2 or 3 is selected, this will enlarge or reduce the wave along the axis of Level.</p>

Parameters	Commands
<div data-bbox="165 336 954 557" style="border: 1px solid black; padding: 5px;"> <p>54. Load/Save S-50 STOP</p> <p>1: Load S-50 Sound</p> <p>2: Save S-50 Sound</p> <p>3: Sound Memo Set</p> <p>Load Save Memo --- ---</p> </div> <p>This function allows you to convert S-50 data (Ver.1.0, Ver.2.0, SYS-503 Type A) into that for the W-30, or convert W-30 data into S-50 (Ver.2.0, SYS-503 Type A) data.</p> <p>*Although Wave data is interpreted identically, the S-50 and W-30 do not support precisely the same parameters. (the W-30 has added features, such as TVF), therefore converted data may sound different.</p> <p>*The FUNC and MIDI settings of the W-30 are retained when supported by the S-50 (Ver.2.0). If not, the values will be altered to an approximate value. Check them and correct if necessary.</p> <p>1: Load S-50 Sound Sound data in the S-50 is loaded (converted) to the W-30.</p> <p>2: Save S-50 Sound Sound data in the W-30 is saved (converted) onto the S-50 (Ver.2.0) disk.</p> <p>3: Sound Memo Set Provides for attaching a memo (max. 60 characters) to be saved along with the sound data.</p> <p>*Patches in the W-30 are numbered 1 through 16 while those on the S-50 are P1 to P8. Therefore, Patches 9 to 96 on the W-30 cannot be saved on the S-50 disk.</p> <p>*While the W-30 accommodates tones 1 to 16, on the S-50 there are 32 tones possible, T11 - T48. As a result, patches that use tones 33 - 96 will be saved as T11 (page 100, 101).</p>	<div data-bbox="1015 921 1339 1325" style="border: 1px solid black; padding: 5px;"> <p>F1 Load</p> <p>This will execute Load S-50 Sound.</p> <p>F2 Save</p> <p>This will execute Save S-50 Sound.</p> <p>F3 Memo</p> <p>This allows creation of a Sound Memo (up to 60 characters) to be saved along with sound data.</p> </div>
<div data-bbox="165 1385 954 1606" style="border: 1px solid black; padding: 5px;"> <p>56. Copy*Move STOP</p> <p>Remaining Time A-0.0s B-0.0s</p> <p>Source [1] MP-1 A0.8</p> <p>Destination [1] MP-1 A0.8</p> <p>Mode Normal</p> <p>Copy-A Copy-B Move-A Move-B Delete</p> </div> <p>The Copy function allows you to copy Wave data and Tone parameters from a source Tone, making a new Original Tone. The Move function is similar to Copy, but it deletes the source Tone at the same time.</p> <div data-bbox="165 1787 925 1957"> </div>	

Parameters	Commands
<p>(NOTE) If the Out Level of the Patch selected in the [36. Patch Parameter] screen is set to 0, the volume in this screen is also set to 0, therefore the Tone cannot be heard.</p> <p>Source (Source Tone to be copied) [1]-[32] Select the Tone you wish to copy or move. (Sub-tones cannot be copied or moved.)</p> <p>Destination (Destination Tone number where the source data is to be written) [1]-[32] Select the destination Tone number where you wish to copy or move the source Tone. (See page 68 "Times when new Wave data is created".) *The destination Tone number cannot be set to the same number as the Source Tone. If you select the same number, the message "Can't Execute" appears.</p> <p>Mode (Copy Mode) [Normal] Wave data is simply copied, in the normal way. [Reverse] Wave data is copied in a reversed direction. Tone parameters are copied in the normal way, so correct the loop with [42. Loop] after copying.</p>	<p>F1 Copy - A This will execute copying. Wave data is written to Wave Bank A.</p> <p>F2 Copy - B This will execute copying. Wave data is written to Wave Bank B.</p> <p>F3 Move - A This will copy the source Tone to a different location and delete the source. Wave data is written to Wave Bank A.</p> <p>F4 Move - B This will copy the source Tone to a different location and delete the source. Wave data is written to Wave Bank B.</p> <p>F5 Delete Delete existing Tones when the remaining space in Wave bank is not sufficient.</p> <p>F1 1tone The Tone selected at [] will be deleted.</p> <p>F2 Bank - A All the Tones that use waves in Wave Bank A will be deleted.</p> <p>F3 Bank - B All the Tones that use waves in Wave Bank B will be deleted.</p> <p>F4 ROM All Tones [33] - [96] take on an unused status, and thus do not sound.</p>

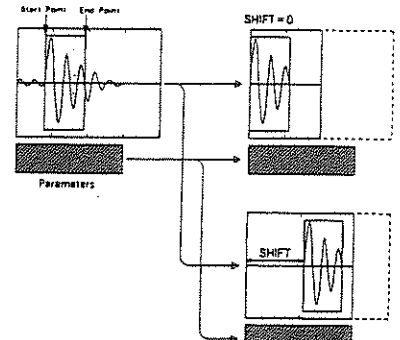
Parameters	Commands
<pre> 57.Truncate Remaining Time A-0.0s B-0.0s Source [1] MP-1 A0.8 Start Point 20 End Point 24326 Shift 0 Search Mode +1 Truncate --- --- --- Graphic </pre>	
<p>This function allows you to remove the unneeded portions of a Wave, and transfer some portions elsewhere. If a space is made at the end of Wave data, and it is larger than one segment, that space will be deleted and added to the Remaining Time.</p> <p>After Truncate is executed, the Start Point and End Point will be changed in accord with the setting for Shift.</p>	<p>F1 Truncate This will execute Truncate.</p>
	
<p>*When Truncate is executed, any Sub-tone that uses that Wave data is deleted. If you wish to retain a Sub-tone, call it with [41. Tone Parameter] (page 153), and temporarily replace the relevant Original Tone with another Tone.</p>	
<p>(NOTE) If the Out Level of the Patch selected in the [36. Patch Parameter] screen is set to 0, the volume in this screen is also set to 0, therefore the Tone cannot be heard.</p>	
<p>[Tone Number] (Tone to be truncated) [1]-[32] Select the Original Tone you wish to truncate. (Sub-tones cannot be truncated.) (Distinguishing Tone Types, see page 68 .)</p> <p>*Truncate will edit Wave data directly. If you wish to retain the original waveform, copy the Tone (page 170).</p>	
<p>Start Point(The beginning address of the needed portion of a wave) (Tone Parameter)</p>	
<p>End Point(The end address of the needed portion of a wave) (Tone Parameter)</p>	
<p>[Address] Set the needed portions of the wave with the Start and End points. You can actually listen to the sound while setting these points. (page 71 "Address")</p> <p>*The addresses of the Start and End Points set here are identical to those set with [42. Loop]. This means that changing addresses here will automatically change those set in [42. Loop].</p>	

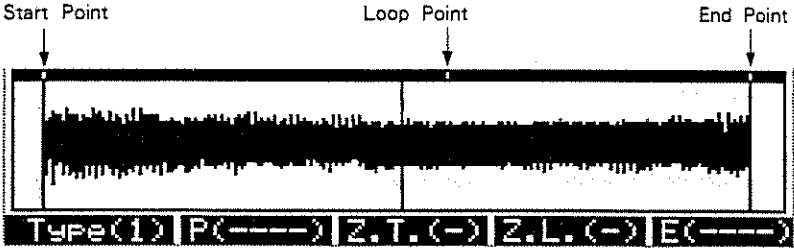
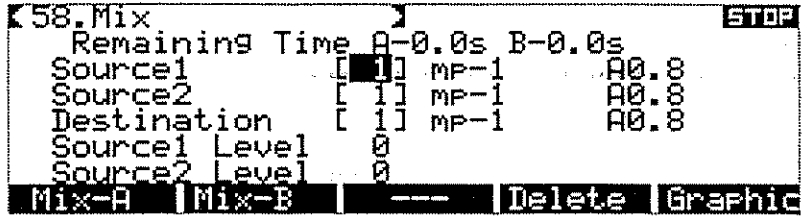
Parameters	Commands
<p>Shift (shifting the Start Point) [Address] The Wave data between the Start and the End points can be shifted forward or backward. Set the address to which the current Start point is to be shifted. When address 0 is set, the Start point will be shifted to the Wave Top.</p> <p>Search Mode This selects how the address actually changes by rotating the dial.</p> <p>[± 1] Address changes in single steps. [± 114] Address changes in steps of 114. [Peak] The W-30 searches the peaks of waves (point where the wave starts increasing or decreasing), advancing from one peak to another. This is called "Peak Search"</p> <p>* In the Shift setting, Peak Search does not work.</p> <p>F5 Graphic</p> <p>This will display the waveform of the selected Tone. When a Sub-tone is selected, it's Original Tone will be displayed.</p> 	<p>F1 Type () This selects a Screen Type; 1, 2 or 3.</p> <p>F2 P () When Screen Type 2 or 3 is selected, this will change the point indicated by the center line.</p> <p>F3 Z.T.() When Screen Type 2 or 3 is selected, this will enlarge or reduce the wave along the axis of Time.</p> <p>F4 Z.L.() When Screen Type 2 or 3 is selected, this will enlarge or reduce the wave along the axis of Level.</p>
 <p>This function mixes two waves to make a new Original Tone.</p>	<p>F1 Mix - A This will execute Mix. Wave data is written to Wave Bank A.</p> <p>F2 Mix - B This will execute Mix. Wave data is written to Wave Bank B.</p>

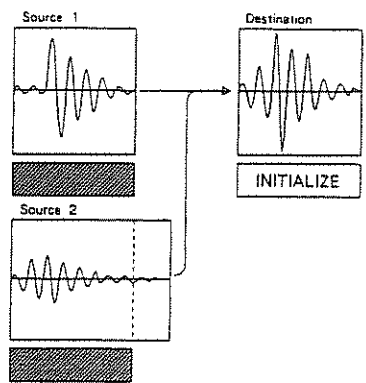
Parameters	Commands
	<p>F5 Delete</p> <p>F1 1tone</p> <p>F2 Bank - A</p> <p>F3 Bank - B</p> <p>F4 ROM All</p> <p>The above function the same as in [56. Copy * Move] See page 171.</p>
<p>(NOTE) If the Out Level of the Patch selected in the [36. Patch Parameter] screen is set to 0, the volume in this screen is also set to 0, therefore the Tone cannot be heard.</p> <p>Source1 (First Tone to be mixed) Source2 (Second Tone to be mixed) [1]-[32] (Sub-tones cannot be mixed.) Specify two Original Tones to be mixed. The length of the new Tone is the same as Source 1's, so select the longer Tone for Source 1.</p> <p>*The two waves are always mixed from address 0, so you may need to truncate the wave beforehand to match the two starting points. (page 172)</p> <p>Destination (Tone where the mixed wave data is written) [1]-[32] The mixture of Source 1 and Source 2 is written to the destination Tone, and all the Tone parameters are initialized. (See page * * "Times when new Wave data is created".) *The destination Tone number cannot be set to the same number as the Source Tone. If you select the same number, the message "Can't Execute" appears.</p> <p>Source1 Level Source2 Level [0]-[127] These set the levels of Source 1 and Source 2. At 127, the waveform is exactly the same as the sample.</p> <p>*The sound may be distorted if both levels are set too high.</p>	<p>F1 Type ()</p> <p>F2 P ()</p> <p>F3 Z.T.()</p> <p>F4 Z.L.()</p> <p>The above function the same as in [57. Truncate].See page 173.</p>
<p>F5 Graphic</p> <p>This will display the waveform of the selected Tone. When a Sub-tone is selected, the wave data of the relevant Original Tone is displayed.</p> <p>*When the cursor is positioned at Source 1, the waveform of Source 1 is displayed. When the cursor is positioned at Source 2, the waveform of Source 2 is displayed. When the cursor is positioned at Destination, the waveform of the Destination Tone is displayed.</p>	

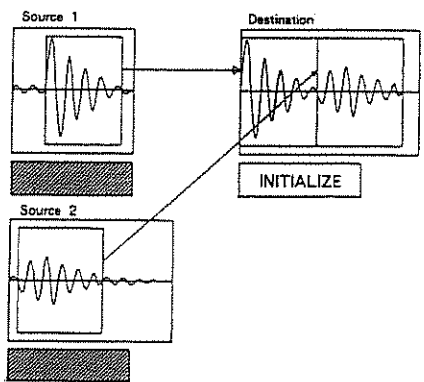
Parameters	Commands
<pre> 59. Combine Source1 [1] MP-1 A0.8 Source2 [1] MP-1 A0.8 Destination [1] MP-1 A0.8 S1 Start 20 End 24326 S2 Start 20 End 24326 Search Mode +1 Cmbin-A Cmbin-B Time Delete Graphic </pre>	<p>F1 Cmbin - A This will execute Combine. Wave data is written to Wave Bank A.</p> <p>F2 Cmbin - B This will execute Combine. Wave data is written to Wave Bank B.</p> <p>F3 Time This will cause the display to show the remaining time of each Wave Bank.</p>
<p>This function combines two sets of wave data to make a new Original Tone.</p>  <p>(NOTE) If the Out Level of the Patch selected in the [36. Patch Parameter] screen is set to 0, the volume in this screen is also set to 0, therefore the Tone cannot be heard.</p> <p>Source1 (First Tone to be combined) Source2 (Second Tone to be combined) [1]-[32] (Sub-tones cannot be combined.) Specify two Original Tones to be combined.</p> <p>Destination (Tone where the combined wave data is written) [1]-[32] The combined data of Source 1 and Source 2 is written to the destination Tone, and all the Tone parameters are initialized. (See page 68 "Times when new Wave data is created".)</p> <p>S1 Start (the beginning address of the needed portion of Source 1) (Tone Parameter) End (the end address of the needed portion of Source 1) (Tone Parameter)</p> <p>S2 Start (the beginning address of the needed portion of Source 2) (Tone Parameter) End (the end address of the needed portion of Source 2) (Tone Parameter) [Address] Set the needed portions of the wave with the Start and End points. You can actually listen to the sound while setting these points. (see "Address", page 71.)</p> <p>*The addresses of the Start and End Points set here are identical to those set with [42. Loop]. This means that changing addresses here will automatically change those set in [42. Loop].</p>	<p>F4 Delete</p> <ul style="list-style-type: none"> F1 1 tone F2 Bank - A F3 Bank - B F4 ROM All <p>The above function the same as in [56. Copy * Move]. See page 171.</p>

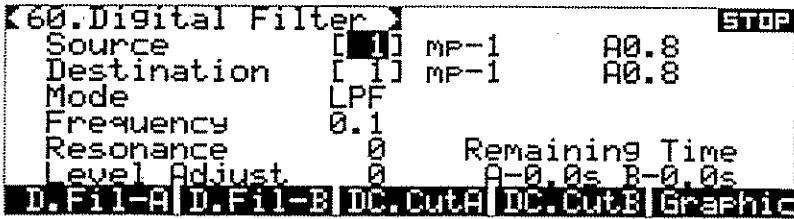
Parameters	Commands
<p>Search Mode This selects how the address actually changes by rotating the dial. [± 1] Address changes in single steps. [± 114] Address changes in steps of 114. [Peak] The W-30 searches for the peaks of waves (point where the wave starts increasing or decreasing), advancing from one peak to another.</p> <p>F5 Graphic</p> <p>This will display the waveform of the selected Tone. When a Sub-tone is selected, the wave data of the relevant Original Tone is displayed.</p> <p>*When the cursor is positioned at Source 1, the waveform of Source 1 is displayed. When the cursor is positioned at Source 2, the waveform of Source 2 is displayed. When the cursor is positioned at Destination, the waveform of the Destination Tone is displayed.</p>	<p>F1 Type ()</p> <p>F2 P ()</p> <p>F3 Z.T. ()</p> <p>F4 Z.L. ()</p> <p>The above function the same as in [57. Truncate]. See page 173.</p>
 <p>This function allows you to process Wave data with a digital filter and make a new Original Tone. You can select one of the two filters: -12dB/Octave Lowpass Filter or Highpass Filter, where cutoff frequency and resonance can be set. By executing D. Filter twice, -24dB/Octave, and three times, -36dBm/Octave filtering effects can be obtained. Digital filtering is performed fully digitally, and thus does not deteriorate the sound quality. Also, if the sample contains DC (direct current) content (low range noise) causing unclear sound, you can cut only the DC content and make a new Original Tone.</p> <p>(NOTE) If the Out Level of the Patch selected in the [36. Patch Parameter] screen is set to 0, the volume in this screen is also set to 0, therefore the Tone cannot be heard.</p> <p>Source (Tone to be digitally filtered) [1]-[32] (Sub-tones cannot be filtered.) Specify the Tone to be digitally filtered.</p>	<p>F1 D.Fil - A This will execute Digital Filtering. Wave data is written into Wave Bank A.</p> <p>F2 D.Fil - B This will execute Digital Filtering. Wave data is written into Wave Bank B.</p> <p>F3 DC.CutA If the sample contains DC content (low range noise) causing unclear sound, you can cut the DC content. Wave data is written into Wave Bank A.</p> <p>F4 DC.CutB If the sample contains DC content (low range noise) causing unclear sound, you can cut the DC content. Wave data is written into Wave Bank B.</p>

Parameters	Commands
<p>Destination (Tone where the digitally filtered Tone is written) [1]-[32] The digitally-filtered or DC cut Tone is written into the destination Tone, and Tone parameters are copied. (See page 68 "Times when new Wave data is created".) *The destination Tone number cannot be set to the same number as the Source Tone. If you select the same number, the message "Can't Execute" appears.</p> <p>Mode (Selecting one of the two Filter modes) [LPF] (Lowpass Filter) This filter passes lower frequencies and cuts higher frequencies. [HPF] (Highpass Filter) This filter passes higher frequencies and cuts lower frequencies.</p> <p>Frequency (Cutoff Frequency) [0.1]-[10.0] This sets the cutoff frequency from 0.1kHz to 10kHz.</p> <p>Resonance [0]-[127] At higher values, the harmonic content at the set cutoff frequency is emphasized.</p> <div data-bbox="470 1021 850 1138" style="text-align: center;"> </div> <p>Level Adjust [0]-[127] At 127, wave data in its original form is sent to the filter. If the sound is distorted (perhaps as a result of resonance settings), adjust the level here. *The digital filtering process is done by computer, therefore, the filtered sound cannot be heard while being filtered. So you may have to repeat the filtering process to obtain the optimum results. *When Level Adjust is set to around 127, the sound may be distorted. If this happens, lower the level and repeat the procedure.</p>	
<p>F5 Graphic</p> <p>This will display the waveform of the selected Tone. When a Sub-tone is selected, the wave data of the relevant Original Tone is displayed.</p> <p>*When the cursor is positioned at Source, the waveform of the source Tone is displayed. When the cursor is positioned at Destination, the waveform of the Destination Tone is displayed.</p>	<p>F1 Type ()</p> <p>F2 P ()</p> <p>F3 Z.T.()</p> <p>F4 Z.L.()</p> <p>The above function the same as in [57. Truncate]. See page 173.</p>

Parameters	Commands
<pre> 61. Wave LOOP [1] MF-1 A0.8 Loop Mode Alter Search Mode ±1 Loop Tune 0 Loop Edit Point Start Point 20 Loop Point 13882 End Point 24326 (Length 10444) Smooth Auto --- --- Graphic </pre>	
<p>By reading out a loop (a region of data lying between the Loop point and End point) repeatedly, you can make a tone sound longer. Sampled waves, however, often have complicated waveforms, therefore it is very difficult to find loop points and end points where waves can be connected smoothly. The Smoothing process of the W-30 allows you to change the shape of the wave from the Loop to the End points so that loops can be connected more naturally.</p> <p>(NOTE) If the Out Level of the Patch selected in the [36. Patch Parameter] screen is set to 0, the volume in this screen is also set to 0, therefore the Tone cannot be heard.</p> <p>Since the wave data of the selected tone will be directly altered, if you wish to retain the original wave, copy the tone first. (see page 170.)</p> <p>[Tone Number] (Tone to be smoothed) [1]-[32] Select the Tone you wish to smooth. (Sub-tones cannot be smoothed.) (Distinguishing Tone Types, see page 68.)</p> <p>Loop Mode (Tone Parameter)</p> <p>[Forward] The sample plays until it reaches the End point, then repeats playing from the Loop point to the End point.</p> <p>[Alter] (Alternate) The sample plays until it reaches the End point, and repeats playing between the Loop point and the End point.</p> <p>[1Shot] (One shot) The sample is played from the Start point to the End point once.</p> <p>[Reverse] The sample plays in a reverse direction (from the End point to the Start point) only once.</p>	<p>F1 Smooth This will execute Smoothing.</p> <p>*The smoothing process is done by computer, therefore, the sound cannot be heard while being processed (P.63, 64).</p> <p>F2 Auto The Auto Loop function can have the W-30's internal computer find the Loop point and End point with Forward looping. Auto Loop can find a new Loop point and End point lying between the Loop point and End point currently set.</p> <p>F1 L→E This will search through the loop from the Loop point to the End point.</p> <p>F2 L←E This will search through the loop from the End point to the Loop point.</p> <p>*Auto Loop may not be able to find a loop because of the selected region for the loop or the type of waveform. Set the loop fairly long and try with different loop length settings to find the optimum loop.</p> <p>*Auto Loop searches only for a Forward loop, therefore, executing Auto Loop will automatically turn the Loop Mode to Forward.</p>

Parameters	Commands
<p>Loop Tune <Tone Parameter> [-64]-[0]-[63] Before entering a loop and after leaving the loop, the pitch may differ. If so, use Loop Tune to adjust it.</p> <p>Start Point <Tone Parameter> Loop Point <Tone Parameter> End Point <Tone Parameter> [Address] The wave lying between the loop point and the end point set here is processed so as to be connected smoothly.</p> <p>*If you execute Auto Loop first, then Smoothing, a more natural loop will be created. *The addresses of points set here are identical to those set with [42. Loop]. This means that changing an address here will automatically change the one set in [42. Loop].</p> <p>*Smoothing cannot be performed in the following cases : ●When the length between the Loop point and End point is less than 228 addresses. ●When the length between the start point and Loop point is less than 124 addresses. ●When the length of wave is more than 4.0s.</p>	
<p>Search Mode This selects how the address actually changes by rotating the dial.</p> <p>[± 1] Address changes in single steps. [± 114] Address changes in steps of 114. [Peak] The W-30 searches for the peaks of waves (point where the wave starts increasing or decreasing), advancing from one peak to another.</p>	
<p>Loop Edit This selects one of the two methods of loop setting.</p> <p>[Point] (Loop Point editing) The Loop point and End point can be separately set.</p> <p>[Length] (Loop Length editing) Moving the End point changes the Loop point together with the End point, but the Loop length is not affected. This is useful for changing the region in the wave chosen for looping in the Forward Loop Mode. (Moving the Loop point changes the Loop length without changing the End point.)</p>	

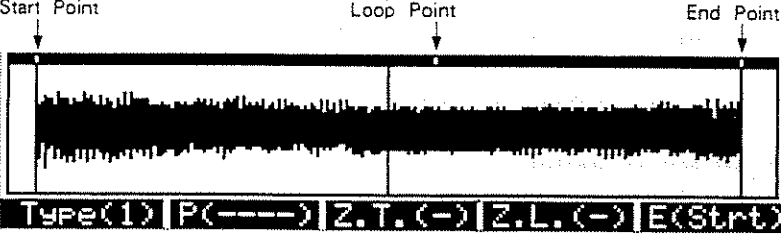
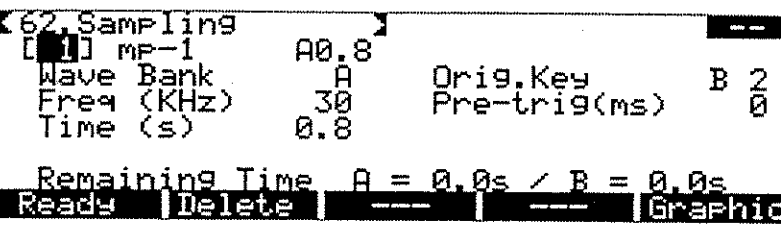
Parameters	Commands
<p>F5 Graphic</p> <p>This will display the waveform of the selected Tone. When a Sub-tone is selected, its Original Tone will be displayed.</p> <p>*The point indicated at F5 E () can be changed using the Value dial. The Value dial functions in accord with the settings made for the search mode.</p> 	<p>F1 Type ()</p> <p>F2 P ()</p> <p>F3 Z.T.()</p> <p>F4 Z.L.()</p> <p>The above function the same as in [42. Loop]. See page 156,157.</p>
 <p>This function allows you to sample external sounds, which are recorded as Wave data (page 77).</p> <p>(NOTE) If the Out Level of the Patch selected in the [36. Patch Parameter] screen is set to 0, the volume in this screen is also set to 0, therefore the Tone cannot be heard.</p> <p>[Tone Number] and Tone Name (Tone Number to be sampled)</p> <p>[1]-[32] Select the Tone you wish to sample. You can select any of the 32 Tone Numbers. (See page 68 "Times when new Wave data is created".)</p> <p>Each Tone can be named using up to 8 characters.</p> <p>F5 Graphic</p> <p>This will display the waveform of the selected Tone. When a Sub-tone is selected, its Original Tone will be displayed.</p> <p>Pressing EXIT returns you to the previous screen.</p> <p>Wave Bank</p> <p>[A],[B] This selects either the A or B Wave Bank for writing the sample.</p>	<p>F1 Type ()</p> <p>F2 P ()</p> <p>F3 Z.T.()</p> <p>F4 Z.L.()</p> <p>The above function the same as in [57. Truncate]. See page 173.</p>

Parameters	Commands
<p>Freq (kHz) (Sampling Frequency) This selects the sampling frequency.</p> <p>[30] This records sound at the 30kHz sampling frequency. [15] This records sound at the 15kHz sampling frequency.</p> <p>Time (s) (Sampling Time) This sets the sampling time (in increments of 0.4 seconds). You can select up to the maximum sampling time. When the 15kHz sampling frequency is selected, consider the sampling time as multiplied by 2 ("× 2" is displayed). When Time = 0.0, sampling cannot be performed.</p> <p>If the maximum sampling time available is longer than that of the sample, select a longer sampling time, so that sampling may be more successful. You can use [57. Truncate] on the wave afterwards if necessary.</p> <p>Orig.Key (Original Key Number) (Tone Parameter) [C0]-[C8] The Original Key Number represents the key at which the sample is played at the original pitch. When sampling from a musical instrument, take into consideration their subsequent use for play, and set Key Numbers appropriate to the pitch of the sampled sound. Middle C is shown as the C4 key, and a semitone as #.</p> <p>*The highest pitch which can be played on the W-30 is 2 octaves above the sampled sound. Higher pitches cannot be played.</p> <p>Pre-Trig (ms) (Pri-trigger) Pre-Trigger allows Wave data to be recorded even before it exceeds the threshold level (or if the threshold level is set to zero, the moment sampling is executed.) In other words, this function begins sampling a little earlier, and therefore prevents the beginning of the sample from being left out.</p> <p>[0ms] The moment wave data reaches the threshold level, sampling starts. [10ms] About 0.01 of a second before wave data reaches the threshold level, sampling starts. [50ms] About 0.05 of a second before wave data reaches the threshold level, sampling starts. [100ms] About 0.1 of a second before wave data reaches the threshold level, sampling starts.</p> <p>*When the 15kHz sampling frequency is selected, the Pre-trigger time is always shown accompanied by "× 2".</p>	<p>F2 Delete When the remaining memory in a Wave bank is insufficient, delete unneeded Tones using this function.</p> <p>F1 1tone This will delete the Tone selected at [].</p> <p>F2 Bank - A This will delete all Tones that use waves in Wave Bank A.</p> <p>F3 Bank - B This will delete all Tones that use waves in Wave Bank B.</p> <p>F4 ROM All Tones [33] - [96] take on an unused status, and thus do not sound.</p>

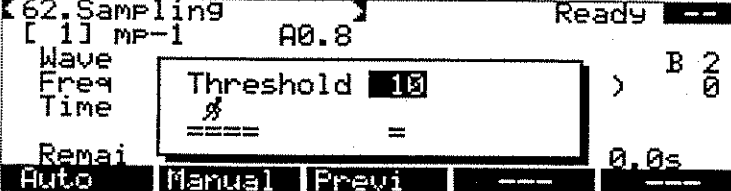
Parameters	Commands
<p>F1 Ready</p> <p>The W-30 gets ready for sampling. The display responds with "Ready" after a moment.</p> <p>*When an Original tone is selected, and F1 is pressed, the wave data of that Original tone will be deleted. Be careful, since this cannot be cancelled.</p> <p>Threshold (Sampling Threshold) [0]-[127] Auto sampling starts the moment a signal of a certain level (threshold level) is fed in. When the threshold level is set to zero, sampling starts the moment sampling is executed.</p> <p>[Input Level Check] As you feed an audio signal, set the level as high as possible without causing the display to show "over", using the Gain Knob on the rear of the unit. The audio signal fed into the W-30 is output through Multi Out 1 and the Headphone socket, so it can be monitored.</p>	<p>F1 Auto (Auto Sampling) Auto sampling starts the moment the threshold is reached, and can begin storing the sample (wave data) as starting a certain time (Pre-trigger time) before the signal fed into the W-30 actually exceeds the threshold level. Data of an amount equivalent to the set sampling time is stored.</p> <p>F2 Manual (Manual Sampling) Manual sampling starts when you press this, and can begin storing the sample as starting a certain time (Pre-trigger time) before that moment. Data of an amount equivalent to the set sampling time is stored.</p>
	<p>F3 Previ (Previous Sampling) Previous sampling considers the moment of start as the wave data's end, and retains wave data of an amount equivalent to the set sampling time, for signals being input before you pressed the button. This is very useful for monitoring to find what you want to sample, and then sample after the fact.</p>
<p>*Sampling through a microphone tends to cause howling. If this happens, turn down the volume of the connected amplifier, and monitor the sound through headphones.</p> <p>[Checking the Sampled Wave]</p> <p>The sampled waveform is shown in the display. You can hear the sample by playing the keyboard.</p> <p>(To return to the Parameter setting display, press EXIT.)</p>	

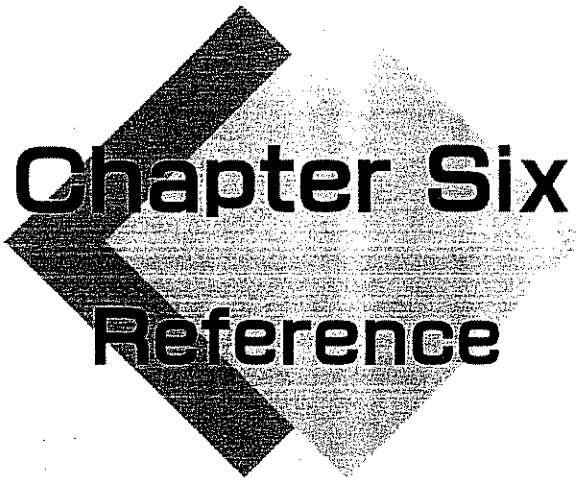

Chapter Six

Reference

1. Table of Data saved onto disks

1. System Configuration Data (Config)

	< Screen >
Patch	[1. Performance]
Level	[1. Performance]
KB Ch	[1. Performance] F3 Config1
	[4. Recorder] F4 KB PRM
	[32. Part Set] F4 KB PRM
KB Oct	[1. Performance] F3 Config1
	[4. Recorder] F4 KB PRM
	[32. Part Set] F4 KB PRM
KB INT	[1. Performance] F3 Config1
	[4. Recorder] F4 KB PRM
	[32. Part Set] F4 KB PRM
KB EXT	[1. Performance] F3 Config1
	[4. Recorder] F4 KB PRM
	[32. Part Set] F4 KB PRM
MIDI INT	[1. Performance] F3 Config1
MIDI EXT	[1. Performance] F3 Config1
TX Sync	[1. Performance] F3 Config1
TX Sens	[1. Performance] F3 Config1
Modulation Depth	[1. Performance] F4 Config2
Pedal SW [DP-2]	[1. Performance] F4 Config2
EXP Pedal [EV-5]	[1. Performance] F4 Config2
Breath Controller	[1. Performance] F4 Config2
Screen Numbers assigned to Function Keys	USER USER

2. Song Data (Song)

◆ Song Parameter

	< The default value >	< Screen >
Song Name	Space	[3. Song Parameter]
Metronome	REC Only	[3. Song Parameter]
Accent	Ch = 10 C # 2 37 Vel 127	[3. Song Parameter]
Normal	Ch = 10 C # 2 37 Vel 64	[3. Song Parameter]
Sync Clock	INT	[3. Song Parameter]
J =	Not initialized	[4. Recorder]
Recording Track	1	[4. Recorder] REC Recording
New M. Beat	4/4	[4. Recorder] REC Recording
REC SW PAF	Off	[4. Recorder] F2 REC SW
C.Chg	On	[4. Recorder] F2 REC SW
P.Chg	On	[4. Recorder] F2 REC SW
CAf	Off	[4. Recorder] F2 REC SW
Bend	On	[4. Recorder] F2 REC SW
Excl (EX & TU)	On	[4. Recorder] F2 REC SW
0 (REC Start Point)	M = 1	[4. Recorder] F5 Loate
9 (REC End Point)	M = 1	[4. Recorder] F5 Loate
1-B (User Point)	M = - - - -	[4. Recorder] F5 Loate
V** (Voice Mode)	Not initialized	[32. Part Set]
Ch	Not initialized	[32. Part Set]
Patch	Not initialized	[32. Part Set]
Level	Not initialized	[32. Part Set]
Output Mode	Not initialized	[32. Part Set]

◆ Track Parameter		
Track Name	Space	[4. Recorder] F3 TRK PRM
Play/Mute (Track Mode)	Play	[4. Recorder] F3 TRK PRM
I = (MIDI Switch)	On	[4. Recorder] F3 TRK PRM
E = (MIDI Switch)	On	[4. Recorder] F3 TRK PRM

◆ Event Data Deleted

3. Sound Data (Sound)

◆ FUNC Parameter		
V ** (Voice Mode)	VAL	[32. Part Set]
Ch	1 - 8	[32. Part Set]
		[33. MIDI RX Set]
Patch	P1 - 8	[32. Part Set]
Level	127	[32. Part Set]
Output Mode	Multi	[32. Part Set]
Master Tune	0	[32. Part Set] F3 M. Tune

◆ MIDI Parameter		
P.Chg	On	[33. MIDI RX Set]
Bend	On	[33. MIDI RX Set]
B. Rng	Off	[33. MIDI RX Set]
Mod	On	[33. MIDI RX Set]
Hold	On	[33. MIDI RX Set]
CAf	Off	[33. MIDI RX Set]
Vol	Off	[33. MIDI RX Set]
PROG #	1 - 16	[34. MIDI Program #]

◆ Patch Parameter		
Patch Name	Space	[36. Patch Parameter]
Key Mode	Norm	[36. Patch Parameter]
		[37. Patch Split]
Key Assign	ROT	[36. Patch Parameter]
Uni-Detune	0	[36. Patch Parameter]
V-SW Thresh	64	[36. Patch Parameter]
V-Mix Ratio	0	[36. Patch Parameter]
Out Level	127	[36. Patch Parameter]
Bend Range	2	[36. Patch Parameter]
AT Assgin	MOD	[36. Patch Parameter]
AT Sense	0	[36. Patch Parameter]
Oct. Shift	0	[36. Patch Parameter]
		[37. Patch Split]
Out Assign	Out 1	[36. Patch Parameter]
1st Tone	Off	[37. Patch Split]
2nd Tone	Off	[37. Patch Split]

◆ Tone Parameter		
Tone name	Space	[41. Tone Parameter]
Orig. Tone	Not initialized	[41. Tone Parameter]
	(When deleted : --)	
Orig. Key	C5	[41. Tone Parameter]

1. Table of Data saved onto disks

P. Follow	On	[41. Tone Parameter]
P. Shift	0	[41. Tone Parameter]
Fine Tune	0	[41. Tone Parameter]
P.LFO Depth	0	[41. Tone Parameter]
P.Bender	On	[41. Tone Parameter]
After Touch	On	[41. Tone Parameter]
Out Assign	Out1	[41. Tone Parameter]
Out Level	127	[41. Tone Parameter]
Loop Mode	1Shot	[42. Loop]
		[61. Wave Loop]
Loop Tune	0	[42. Loop]
		[61. Wave Loop]
[T1] - [T32] Start Point	0	[42. Loop]
		[61. Wave Loop]
[T1] - [T32] Loop Point	0	[42. Loop]
		[61. Wave Loop]
[T1] - [T32] End Point	Last Address	[42. Loop]
		[61. Wave Loop]
[T33] - [T96] Start Point	0	[42. Loop]
[T33] - [T96] Loop Point	0	[42. Loop]
[T33] - [T96] End Point	262143 (When deleted : 0)	[42. Loop]
LFO Rate	88	[43. LFO]
LFO Sync	On	[43. LFO]
LFO Mode	Sin	[43. LFO]
LFO Delay	0	[43. LFO]
LFO Offset	0	[43. LFO]
LFO Polarity	+	[43. LFO]
TVF Switch	Off	[44. TVF Page 1]
TVF Cut-off	127	[44. TVF Page 1]
TVF Resonance	0	[44. TVF Page 1]
TVF Key Follow	0	[44. TVF Page 1]
TVF LFO Depth	0	[44. TVF Page 1]
TVF L Curve	2	[44. TVF Page 1]
TVF EG Depth	0	[44. TVF Page 1]
TVF EG Pol.	+	[44. TVF Page 1]
TVF Key Rate	0	[44. TVF Page 1]
TVF Vel Rate	0	[44. TVF Page 1]
TVF EG Rate 1 - 8	127	[45. TVF Page 2]
TVF EG Level 1 - 2	127	[45. TVF Page 2]
TVF EG Level 3 - 8	0	[45. TVF Page 2]
TVF EG Sus	2	[45. TVF Page 2]
TVF EG End	3	[45. TVF Page 2]
TVF Zoom	3	[45. TVF Page 2]
TVA LFO Depth	0	[46. TVA Page 1]
TVA L Curve	2	[46. TVA Page 1]
TVA Key Rate	0	[46. TVA Page 1]
TVA Vel Rate	0	[46. TVA Page 1]
TVA EG Rate 1 - 8	127	[47. TVA Page 2]
TVA EG Level 1 - 2	127	[47. TVA Page 2]
TVA EG Level 3 - 8	0	[47. TVA Page 2]
TVA EG Sus	2	[47. TVA Page 2]
TVA EG End	3	[47. TVA Page 2]
TVA Zoom	3	[47. TVA Page 2]

2. Error and Other Messages

●Disk Protected

Displayed whenever you have tried to save data onto a disk while its tab is still set to the PROTECT position. You should move the protect tab to the WRITE position.

●Disk Error

Displayed when an abnormality (such as when data has been damaged) occurs with the disk during loading.

●Insert Disk

Displayed when you have tried to load or save without inserting a disk into the drive.

●No Song Data

Displayed when you have tried to load a song from a disk not containing any song data; or when you have tried to edit a song that has no data.

●Disk Full

Displayed when you try to save to a disk which has already reached its capacity limit.

●Overwrite OK ?

Displayed when you try to save a song, and one having the same name already exists on the disk. If you do not wish to erase the song already on disk, change the name of the one you are going to save.

*When saving to a Super-MRC disk, you cannot save a song having an already existing name.

●Out of Memory

Internal memory has reached full capacity. Displayed in the course of load/recording/edit operations. Also displayed while loading patches, indicating that wave bank memory is already full.

●Not MRC Disk

The disk is not an MRC-500, MRC-300, or Super-MRC disk. Displayed while trying to load a song in the [25. Load MRC Song] screen.

●Not S-MRC Disk

The disk is not a Super-MRC disk. Displayed while trying to save a song in the [27. Save S-MRC Disk] screen.

●Not S Song Disk

The disk is not a SYS-553, SYS-333, or SYS-503 disk. Displayed while trying to load a song in the [26. Load S Song] screen.

●Not S-50 Disk

The disk is not an S-50 disk. Displayed in the [54. Load/Save S-50] screen when you try to load/save sound data. For loading you are able to use Ver.1.0 and Ver.2.0 disks; and for saving, Ver.2.0 disks.

●Not Song Disk

The disk is not of the song data format (Song disk, or Sound & Song disk). Displayed while trying to load/save song data.

●Not Sound Disk

The disk is not of the sound data format (Sound & Song disk; S-550, S-330 disks). Displayed while trying to load/save sound data.

●Not System Disk

The disk is not a system disk. Displayed while attempting to load a system utility.

●Level Over

Displayed when, in carrying out digital filtering or mixing, there is a risk of producing distortion since the acceptable limits for level are exceeded.

●Data Size Over

The amount of Exclusive data is too large to be edited. The maximum is 500 bytes.

●Data Error

The format is not one for which a checksum for the Exclusive data can be calculated. Displayed when the manufacturer's ID is other than that for Roland, or when the data size does not match the format. For details, refer to page 192, "Roland Exclusive Messages."

●Point Error

Displayed, while recording songs in the loop mode, when the locate points (REC start point and REC end point) are set within the same measure. Make sure you allow at least 1 measure between the points set.

3. Troubleshooting

● Can't Execute

Displayed when there is an error in parameter settings, such as when there is no space at all for writing wave data, or when the same tone number as the source is chosen as the destination of a write operation. Also displayed when you have tried to copy a disk different than that specified with FD Copy.

● Insert System Disk and press 'F1 : Load

Displayed when you have selected a screen that loads relevant system utilities when needed. Insert the system disk and load the required system utilities. This message does not appear when the system disk has remained inserted.

● Insert New Disk

Displayed in the [28. FD Copy] screen, prompting you to insert the disk that is the destination of the copy.

● Insert Destination Disk

Displayed in the [29. Song Transfer] screen, prompting you to insert the disk that is the destination of the copy.

● Over Work

Displayed in situations where, as a result of the data processing state of the W-30, the sequencer is unable to proceed normally.

● MIDI Overflow

Displayed when an amount of MIDI data exceeding that which can be processed has been received at MIDI IN.

● Active Sense Error

Displayed when it has been determined, through active sensing messages, that the connection has been broken.

[No sound is produced by the W-30]

● Check that cables and connections are in proper order.

● Check that the volume on amp, mixer, or external MIDI device is not too low.

● Do you have the W-30 volume set too low?

○ Position of volume knob. (☞ P.5)

○ Level set for each part. (☞ P.145)

○ Out level set for each patch. (☞ P.149)

○ Out level set for each tone. (☞ P.154)

○ Level of the patch assigned to the keyboard in the Performance screen. (☞ P.110)

○ The value for volume sent by an EV-5 to which the volume function (Control Change No. 7) has been assigned. (With the pedal released completely, volume is 0.) (☞ P.99, 112)

○ Output level of the patch selected in the Patch Edit screen. (☞ P.149)

In both the Tone Edit and Wave Edit screens, sound will be produced at the same level as that set for the patch currently selected in the Patch Edit screen.

○ The Out Assign of the patch selected in the Patch Edit screen. (☞ P.150)

In both the Tone Edit and Wave Edit screens, sound will be output in accord with the same setting for output assignment as that of the patch currently selected in the Patch Edit screen.

● Are you sure MIDI channels are chosen properly?

○ MIDI channel of each part. (☞ P.145)

○ The channel in each track. (☞ P.142)

○ The keyboard channel (☞ P.110)

● Do you have MIDI switches set to "off"?

○ Each track's MIDI transmit switch. (☞ P.117)

○ The keyboard's MIDI transmit switch. (☞ P.111)

○ The MIDI IN switch : MIDI (INT/EXT) (☞ P.111)

● Are you sure your connections to the multi-output sockets are proper?

- Recheck the Output Mode of the part, and the Out Assign of the patch. (☞P.53 "To Change Output Sockets")
- Do you have any tracks set to "mute"? If set to mute, no note messages are transmitted. (☞P.117)
- Have you made assignment of "Off" when setting Tone Split for the patch? (☞P.151)
- No sound can be produced 2 octaves above the Orig. Key (☞P.153) setting for the tone.

[Pitch sounds strange]

- Check that Master Tune is set properly. (☞P.145)
- Are external MIDI sound modules tuned properly? (☞P.110)
- Check that the keyboard's octave shift setting hasn't been changed. (☞P.111)
- Are settings for the octave shift of each patch (valid only respective to the keyboard), and unison detune the way they should be? (☞P.149, 150)
- Have you, in consideration of how the sound will be actually used in performance, made setting of a key number that suits the pitch of the sampled sound, in the Orig. Key tone parameter? (☞P.153)
- Check settings for each tone's pitch follow, pitch shift, and fine tune. (☞P.153, 154)

[No effect obtained with Aftertouch]

- Check if any Part's Aftertouch MIDI message receive switch is set to "Off." (☞P.147)
- Is the Aftertouch Sens set to "0" for any of the patches? (☞P.150)
- Is the Aftertouch switch set to "Off" for any of the tones? (☞P.154)

[No pitch change obtained when modulation bender lever is moved]

- Is the Bender message MIDI receive switch set to "Off" for any of the Parts? (☞P.146)
- Is the Bender Range set to "0" for any of the patches? (☞P.149)
- Is the setting for Pitch Bender set to "Off" for any of the tones? (☞P.154)

[You can't get softness/loudness the way you want it]

- Recheck settings for the tone's Level Curve, Envelope, Key Rate, and Velocity Rate. (☞P.163,164)
- Are your external MIDI devices capable of response to Velocity?

[Patches don't change properly]

- When changing by means of Program Change messages, recheck your settings for the following :
 - Are MIDI switch set to "Off", while wanting to receive program changes from an external MIDI device? (☞P.11)
 - Is the MIDI transmit switch on any track set to "Off"? (☞P.117)
 - While transmitting program change messages from the keyboard; have you checked that the keyboard's MIDI transmit switch is not set to "Off"? (☞P.117, 118)?
 - Is the Program Change message MIDI receive switch for any Part set to "Off"? (☞P.146)
 - Have you confirmed that settings for program change numbers and patch numbers correspond properly? (☞P.147)
 - Do you have the correct MIDI channels set? ("No sound is produced by the W-30" ☞P.188)

[You have problems recording]

- Are any MIDI message-specific recording switches set to "Off"? (☞ P.117)
- Is the Sync Clock for the song parameter set to EXT? When set to EXT, recording takes place based on reception at MIDI IN of the Clock, Start, Continue, Stop, Song Position Pointer, and Song Select MIDI system messages. (☞ P.198 MIDI Implementation)
- Check that the recording mode is set as it should be. In any mode other than Loop, existing data will be erased.
- Has the total number of steps for songs exceeded approx. 15,000?
- While using the Auto Punch or Loop recording modes, have you set the REC start and end points? In Loop mode, make sure you provide at least 1 measure between these points. (☞ P.118)

[Metronome is not heard]

- Make sure the metronome is not set to "Off." (☞ P.113)
- Check that the metronome's MIDI channel is set properly. (☞ P.113)
When set to channels [1] - [16], the patch assigned to the Part corresponding to the relevant channel is what sounds. When set to [E1] - [E16] it is always transmit from MIDI OUT.
- Check that the metronome's note number has been set properly. When the patch is sounded, no sound will be produced at positions higher than 2 octaves above the tone's Orig. Key setting. (☞ P.153)
- Make sure the velocity for the metronome is not set at "0." (☞ P.113)

[Song cannot be played]

- Is the Sync Clock for the song parameter set to EXT? When set to EXT, song play takes place based on reception at MIDI IN of the Clock, Start, Continue, Stop, Song Position Pointer, and Song Select MIDI system messages. (☞ P.198 MIDI Implementation)
- You may be at the last measure in the song data. Set it at M = 1. (☞ P.114)

[Beat setting cannot be made]

- The beat of a measure cannot be changed after recording has taken place. Settings for beat are valid only when the measure has not yet been recorded. (☞ P.83, 115 "New M. Beat")

[Synchronized recording/play doesn't work properly]

- When using the W-30 as the slave for synchronized recording/play.
 - Check that the Sync Clock for the song parameters is set to EXT. (☞ P.113) (☞ P.198 MIDI Implementation)
 - Check that the external sequencer is set to transmit clock messages.
- When using the W-30 as the master for synchronized play.
 - Check that the Sync Clock for the song parameters is set to INT. (☞ P.113)
 - Check that the system configuration's MIDI sync is set to "On." (☞ P.111) (☞ P.198 MIDI Implementation)
 - Make sure the external sequencer is set to receive clock messages.
- Make sure all connections have been made properly.

【Sampling doesn't work】

- Make sure there is enough free space in the wave banks. (A/B) If insufficient, delete unneeded Original tones. (☞P.181)
- Make sure the sampling time has been set to something other than 0.0. (☞P.181)

【Part settings have changed】

- Data comprising settings for Parts (FUNC) is included with both song and sound data. When loaded separately, the settings that take effect will be those of the data loaded last. Be careful of the order in which loading is carried out.
(☞P.39 "About FUNC Data")

【Sounds are left out】

- The W-30 is capable of producing a maximum of 16 voices simultaneously. Beyond this limit sound will not be produced.
- Check the key mode of the patch being played. With Fade, Mix, and Uni, 2 voices are used when a key is pressed, thus the practical number of simultaneously producible voices is reduced.
- Recheck the setting for voice mode. (☞P.144)
- Has the output for the tone been distributed? At such times, some sounds may be left out. (☞P.53, 150)
- Is there a block of Exclusive messages contained within the song data? This could at times prevent normal output of a song.

【Split settings cannot be made】

- Make sure you have the appropriate mode selected. While at "Info" settings cannot be made. (☞P.58, 151)

【Waves cannot be edited】

- Check that settings for source tone and destination tone have been made properly. The same tone cannot be set as both source and destination.
- Make sure there is enough free space in the destination wave bank. (A/B) If insufficient, delete unneeded Original tones. (☞P.171)

Roland Exclusive Messages

1. Data Format for Exclusive Messages

Roland's MIDI implementation uses the following data format for all exclusive messages (type IV):

Byte	Description
F0H	Exclusive status
41H	Manufacturer ID (Roland)
DEV	Device ID
MDL	Model ID
CMD	Command ID
[BODY]	Main data
F7H	End of exclusive

= MIDI status : F0H, F7H

An exclusive message must be flanked by a pair of status codes, starting with a Manufacturer - ID immediately after F0H (MIDI version 1.0).

= Manufacturer - ID : 41H

The Manufacturer - ID identifies the manufacturer of a MIDI instrument that triggers an exclusive message. Value 41H represents Roland's Manufacturer - ID.

= Device - ID : DEV

The Device - ID contains a unique value that identifies the individual device in the multiple implementation of MIDI instruments. It is usually set to 00H - 0FH, a value smaller by one than that of a basic channel, but value 00H - 1FH may be used for a device with multiple basic channels.

= Model - ID : MDL

The Model - ID contains a value that uniquely identifies one model from another. Different models, however, may share an identical Model - ID if they handle similar data.

The Model - ID format may contain 00H in one or more places to provide an extended data field. The following are examples of valid Model - IDs, each representing a unique model:

01H
02H
03H
00H, 01H
00H, 02H
00H, 00H, 01H

= Command - ID : CMD

The Command - ID indicates the function of an exclusive message. The Command - ID format may contain 00H in one or more places to provide an extended data field. The following are examples of valid Command - IDs, each representing a unique function:

01H
02H
03H
00H, 01H
00H, 02H
00H, 00H, 01H

= Main data : BODY

This field contains a message to be exchanged across an interface. The exact data size and contents will vary with the Model - ID and Command - ID.

2. Address - mapped Data Transfer

Address mapping is a technique for transferring messages conforming to the data format given in Section 1. It assigns a series of memory - resident records - waveform and tone data, switch status, and parameters, for example - to specific locations in a machine - dependent address space, thereby allowing access to data residing at the address a message specifies.

Address - mapped data transfer is therefore independent of models and data categories. This technique allows use of two different transfer procedures: one - way transfer and handshake transfer.

= One - way transfer procedure (See Section 3 for details.)

This procedure is suited for the transfer of a small amount of data. It sends out an exclusive message completely independent of a receiving device status.

Connection Diagram

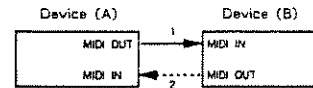

Connection at point 2 is essential for "Request data" procedures. (See Section 3.)

= Handshake - transfer procedure (See Section 4 for details.)

This procedure initiates a predetermined transfer sequence (handshaking) across the interface before data transfer takes place. Handshaking ensures that reliability and transfer speed are high enough to handle a large amount of data.

Connection Diagram

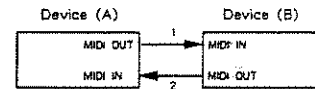

Connection at points 1 and 2 is essential.

Notes on the above two procedures

- * There are separate Command - IDs for different transfer procedures.
- * Devices A and B cannot exchange data unless they use the same transfer procedure, share identical Device - ID and Model ID, and are ready for communication.

3. One - way Transfer Procedure

This procedure sends out data all the way until it stops and is used when the messages are so short that answerbacks need not be checked.

For long messages, however, the receiving device must acquire each message in time with the transfer sequence, which inserts intervals of at least 20 milliseconds in between.

Types of Messages

Message	Command ID
Request data 1	RQ1 (11H)
Data set 1	DT1 (12H)

= Request data = 1 : RQ1 (11H)

This message is sent out when there is a need to acquire data from a device at the other end of the interface. It contains data for the address and size that specify designation and length, respectively, of data required.

On receiving an RQ1 message, the remote device checks its memory for the data address and size that satisfy the request.

If it finds them and is ready for communication, the device will transmit a "Data set 1 (DT1)" message, which contains the requested data. Otherwise, the device will send out nothing.

Byte	Description
F0H	Exclusive status
41H	Manufacturer ID (Roland)
DEV	Device ID
MDL	Model ID
11H	Command ID
aaH	Address MSB
⋮	⋮
⋮	⋮
⋮	LSB
ssH	Size MSB
⋮	⋮
⋮	⋮
⋮	LSB
sum	Check sum
F7H	End of exclusive

- *The size of the requested data does not indicate the number of bytes that will make up a DT1 message, but represents the address fields where the requested data resides.
- *Some models are subject to limitations in data format used for a single transaction. Requested data, for example, may have a limit in length or must be divided into predetermined address fields before it is exchanged across the interface.
- *The same number of bytes comprises address and size data, which, however, vary with the Model - ID.
- *The error checking process uses a checksum that provides a bit pattern where the least significant 7 bits are zero when values for an address, size, and that checksum are summed.

= Data set 1 : DT1 (12H)

This message corresponds to the actual data transfer process. Because every byte in the data is assigned a unique address, a DT1 message can convey the starting address of one or more data as well as a series of data formatted in an address - dependent order.

The MIDI standards inhibit non - real time messages from interrupting an exclusive one. This fact is inconvenient for the devices that support a "soft - through" mechanism. To maintain compatibility with such devices, Roland has limited the DT1 to 256 bytes so that an excessively long message is sent out in separate segments.

Byte	Description
F0H	Exclusive
41H	Manufacturer ID (Roland)
DEV	Device ID
MDL	Model ID
12H	Command ID
aaH	Address MSB
⋮	⋮
⋮	⋮
⋮	⋮
ddH	Data
⋮	⋮
⋮	⋮
sum	Check sum
F7H	End of exclusive

- *A DT1 message is capable of providing only the valid data among those specified by an RQ1 message.
- *Some models are subject to limitations in data format used for a single transaction. Requested data, for example, may have a limit in length or must be divided into predetermined address fields before it is exchanged across the interface.
- *The number of bytes comprising address data varies from one Model - ID to another.
- *The error checking process uses a checksum that provides a bit pattern where the least significant 7 bits are zero when values for an address, size, and that checksum are summed.

= Example of Message Transactions

- Device A sending data to Device B
Transfer of a DT1 message is all that takes place.

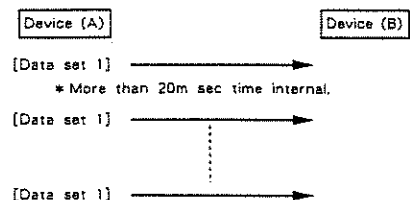

- Device B requesting data from Device A
Device B sends an RQ1 message to Device A. Checking the message, Device A sends a DT1 message back to Device B.

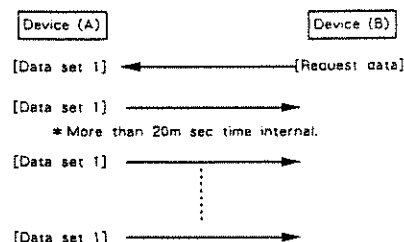

4. Handshake - Transfer Procedure

Handshaking is an interactive process where two devices exchange error checking signals before a message transaction takes place, thereby increasing data reliability. Unlike one way transfer that inserts a pause between message transactions, handshake transfer allows much speedier transactions because data transfer starts once the receiving device returns a ready signal.

When it comes to handling large amounts of data - sampler waveforms and synthesizer tones over the entire range, for example - - across a MIDI interface, handshaking transfer is more efficient than one - way transfer.

Types of Messages

Message	Command ID
Want to send data	WSD (40H)
Request data	RQD (41H)
Data set	DAT (42H)
Acknowledge	ACK (43H)
End of data	EDD (45H)
Communication error	ERR (4EH)
Rejection	RJC (4FH)

= Want to send data : WSD (40H)

This message is sent out when data must be sent to a device at the other end of the interface. It contains data for the address and size that specify designation and length, respectively, of the data to be sent.

On receiving a WSD message, the remote device checks its memory for the specified data address and size which will satisfy the request. If it finds them and is ready for communication, the device will return an "Acknowledge (ACK)" message. Otherwise, it will return a "Rejection (RJC)" message.

Byte	Description
F0H	Exclusive status
41H	Manufacturer ID (Roland)
DEV	Device ID
MDL	Model ID
40H	Command ID
aaH	Address MSB
⋮	⋮
⋮	⋮
⋮	⋮
ssH	Size MSB
⋮	⋮
⋮	⋮
⋮	⋮
sum	Check sum
F7H	End of exclusive

- *The size of the data to be sent does not indicate the number of bytes that make up a "Data set (DAT)" message, but represents the address fields where the data should reside.
- *Some models are subject to limitations in data format used for a single transaction. Requested data, for example, may have a limit in length or must be divided into predetermined address fields before it is exchanged across the interface.
- *The same number of bytes comprises address and size data, which, however, vary with the Model ID.
- *The error checking process uses a checksum that provides a bit pattern where the least significant 7 bits are zero when values for an address, size, and that checksum are summed.

= Request data : RQD (41H)

This message is sent out when there is a need to acquire data from a device at the other end of the interface. It contains data for the address and size that specify designation and length, respectively, of data required.

On receiving an RQD message, the remote device checks its memory for the data address and size which satisfy the request. If it finds them and is ready for communication, the device will transmit a "Data set (DAT)" message, which contains the requested data. Otherwise, it will return a "Rejection (RJC)" message.

Byte	Description
F0H	Exclusive status
41H	Manufacturer ID (Roland)
DEV	Device ID
MDL	Model ID
41H	Command ID
aaH	Address MSB
⋮	⋮
	LSB
ssH	Size MSB
⋮	⋮
	LSB
sum	Check sum
F7H	End of exclusive

- *The size of the requested data does not indicate the number of bytes that make up a "Data set (DAT)" message, but represents the address fields where the requested data resides.
- *Some models are subject to limitations in data format used for a single transaction. Requested data, for example, may have a limit in length or must be divided into predetermined address fields before it is exchanged across the interface.
- *The same number of bytes comprises address and size data, which, however, vary with the Model - ID.
- *The error checking process uses a checksum that provides a bit pattern where the least significant 7 bits are zero when values for an address, size, and that checksum are summed.

= Data set : DAT (42H)

This message corresponds to the actual data transfer process. Because every byte in the data is assigned a unique address, the message can convey the starting address of one or more data as well as a series of data formatted in an address - dependent order.

Although the MIDI standards inhibit non - real time messages from interrupting an exclusive one, some devices support a "soft - through" mechanism for such interrupts. To maintain compatibility with such devices, Roland has limited the DAT to 256 bytes so that an excessively long message is sent out in separate segments.

Byte	Description
F0H	Exclusive status
41H	Manufacturer ID (Roland)
DEV	Device ID
MDL	Model ID
42H	Command ID
aaH	Address MSB
⋮	⋮
	LSB
ddH	Data
⋮	⋮
sum	Check sum
F7H	End of exclusive

- *A DAT message is capable of providing only the valid data among those specified by an RQD or WSD message.
- *Some models are subject to limitations in data format used for a single transaction. Requested data, for example, may have a limit in length or must be divided into predetermined address fields before it is exchanged across the interface.
- *The number of bytes comprising address data varies from one model ID to another.
- *The error checking process uses a checksum that provides a bit pattern where the least significant 7 bits are zero when values for an address, size, and that checksum are summed.

= Acknowledge : ACK (43H)

This message is sent out when no error was detected on reception of a WSD, DAT, "End of data (EOD)", or some other message and a requested setup or action is complete. Unless it receives an ACK message, the device at the other end will not proceed to the next operation.

Byte	Description
F0H	Exclusive status
41H	Manufacturer ID (Roland)
DEV	Device ID
MDL	Model ID
43H	Command ID
F7H	End of exclusive

= End of data : EOD (45H)

This message is sent out to inform a remote device of the end of a message. Communication, however, will not come to an end unless the remote device returns an ACK message even though an EOD message was transmitted.

Byte	Description
F0H	Exclusive status
41H	Manufacturer ID (Roland)
DEV	Device ID
MDL	Model ID
45H	Command ID
F7H	End of exclusive

= Communications error : ERR (4EH)

This message warns the remote device of a communications fault encountered during message transmission due, for example, to a checksum error. An ERR message may be replaced with a "Rejection (RJC)" one, which terminates the current message transaction in midstream.

When it receives an ERR message, the sending device may either attempt to send out the last message a second time or terminate communication by sending out an RJC message.

Byte	Description
F0H	Exclusive status
41H	Manufacturer ID (Roland)
DEV	Device ID
MDL	Model ID
4EH	Command ID
F7H	End of exclusive

= Rejection : RJC (4FH)

This message is sent out when there is a need to terminate communication by overriding the current message. An RJC message will be triggered when :

- a WSD or RQD message has specified an illegal data address or size.
- the device is not ready for communication.
- an illegal number of addresses or data has been detected.
- data transfer has been terminated by an operator.
- a communications error has occurred.

An ERR message may be sent out by a device on either side of the interface. Communication must be terminated immediately when either side triggers an ERR message.

Byte	Description
FOH	Exclusive status
41H	Manufacturer ID (Roland)
DEV	Device ID
MDL	Model ID
4FH	Command ID
F7H	End of exclusive

= Example of Message Transactions

- Data transfer from device (A) to device (B).

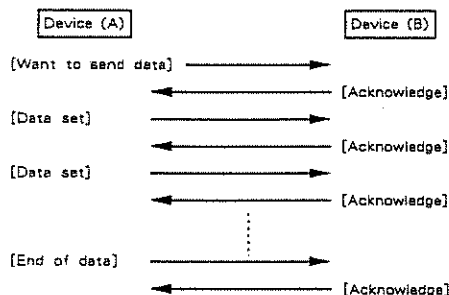

- Device (A) requests and receives data from device (B).

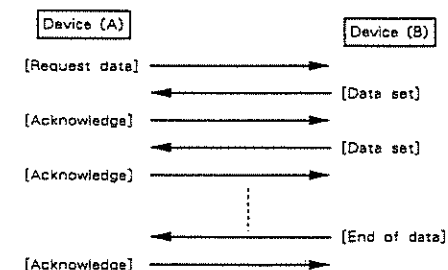

- Error occurs while device (A) is receiving data from device (B).

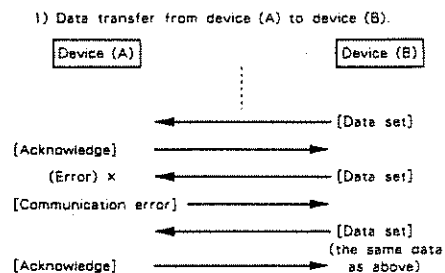

- 2) Device (B) rejects the data re-transmitted, and quits data transfer.

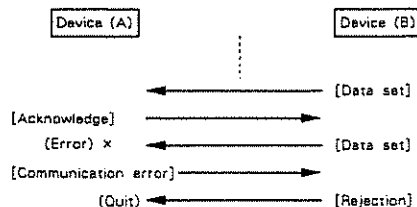

- 3) Device (A) immediately quits data transfer.

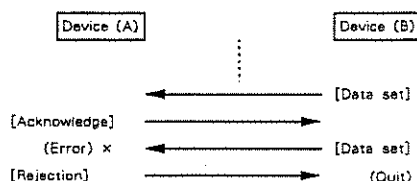

About W-30 Exclusive Messages

On the W-30, transmission and reception of Exclusive messages occurs only in the Sequencer section. The function is unavailable in the Sound section.

■ Recording Exclusive Messages

In the sequencer, Exclusive messages are recorded as song data.

Perform the same operation as you would for recording songs when wishing to record Exclusive messages received at MIDI IN.

- * Put the Excl recording switch to "On." (see page 117.)

■ Transmitting the Exclusive messages you have recorded.

Play the relevant song in order to transmit Exclusive messages from MIDI OUT.

- * Set the MIDI (EXT) switch for each track to "On." (see page 117.)

■ Editing Exclusive Messages

Up to a maximum of 500 bytes of exclusive messages can be edited in the Micro Edit screen. (see page 120.)

Calculation of the checksum cannot be performed, and "Data Error" will be displayed when the manufacturer's ID is one other than that for Roland (41), or when the data size does not match the format. When successfully calculated, "Complete" is displayed, and the calculated value is automatically written into the last byte. For details, see page 192, "Roland Exclusive Messages."

- * Take care whenever exclusive messages are included inside song data, since the sound may at times not be produced normally.

MIDI Implementation Chart

Function ...		Transmitted	Recognized	Remarks
Basic Channel	Default Changed	1 1 - 16	1 - 16 * 4 1 - 16 * 4	* 2
Mode	Default Messages Altered	Mode 3 x *****	Mode 3 x	
Note Number	True Voice	12 - 120 *****	12 - 120 12 - 120	
Velocity	Note ON Note OFF	○ x 9n v = 0	○ x	v = 1 - 127
After Touch	Key's Ch's	x x	x * 1	
Pitch Bender		x	* 1	
Control Change	1	○	* 1	Modulation Breath Controller Volume Hold 1
	2	x	* 1	
Control Change	7	x	* 1	RPN LSB, MSB Data entry LSB, MSB Number 0 Pitch Bend Sensitivity
	64	○	* 1	
Control Change	100, 101	* 5	* 1	
	6, 38			
Prog Change	True #	○ *****	* 1 0 - 127 0 - 127	* 3
System Exclusive		x	x	
System Common	Song Pos	x	x	
	Song Sel	x	x	
	Tune	x	x	
System Real Time	Clock	x	x	
	Commands	x	x	
Aux Message	Local ON/OFF	x	x	
	All Notes OFF	x	○ (123 - 127)	
	Active Sense	* 1	○	
	Reset	x	x	
Notes		* 1 Can be set to ○ or x manually, and memorized on disk. * 2 Can be memorized on disk. * 3 Program change number for each Patch can be set freely. * 4 Can be set up to 8 different channels. * 5 Control Changes (number 0 - 95) can be sent by moving the EV - 5 to which Control Change number is assigned.		

Mode 1 : OMNI ON, POLY
Mode 3 : OMNI OFF, POLY

Mode 2 : OMNI ON, MONO
Mode 4 : OMNI OFF, MONO

○ : Yes
x : No

MIDI Implementation Chart

Function ...		Transmitted	Recognized	Remarks
Basic Channel	Default Changed	all ch x	all ch 1 - 16	not BASIC ch
Mode	Default Messages Altered	x x *****	x x	
Note Number	True Voice	0 - 127 *****	0 - 127 0 - 127	
Velocity	Note ON Note OFF	○ x 9n v = 0	○ x	v = 1 - 127
After Touch	Key's Ch's	○ ○	* 1 * 1	
Pitch Bender		○	* 1	
Control Change	0 - 63	○	* 1	
	64 - 121	○	* 1	
Prog Change	True #	○ *****	* 1 0 - 127	
System Exclusive		○	○	
System Common	Song Pos Song Sel Tune	○ (CLOCK = INT) ○ (CLOCK = INT) ○	○ (CLOCK = EXT) ○ (CLOCK = EXT) ○	
System Real Time	Clock Commands	○ (CLOCK = INT) ○ (CLOCK = INT)	○ (CLOCK = EXT) ○ (CLOCK = EXT)	
Aux Message	Local ON/OFF All Notes OFF Active Sense Reset	x x * 2 x	x ○ (123 - 127) ○ x	
Notes		* 1 Can be set to ○ or x manually. * 2 According to the setting of Keyboard & Internal voice section.		

Mode 1 : OMNI ON, POLY
Mode 3 : OMNI OFF, POLY

Mode 2 : OMNI ON, MONO
Mode 4 : OMNI OFF, MONO

○ : Yes
x : No

1. TRANSMITTED DATA (Keyboard section)

■ Channel Voice Message

● Note off

Status	Second	Third	
BnH	kkH	00H	
n = MIDI channel number	: 0H - FH (0 - 15)	0 = ch.1 15 = ch.16	
kk = Note number	: 0CH - 7BH (12 - 120)		

● Note on

Status	Second	Third	
BnH	kkH	vvH	
n = MIDI channel number	: 0H - FH (0 - 15)	0 = ch.1 15 = ch.16	
kk = Note number	: 0CH - 7BH (12 - 120)		
vv = Velocity	: 01H - 7FH (1 - 127)		

● Control change

Status	Second	Third	
BnH	kkH	vvH	
n = MIDI channel number	: 0H - FH (0 - 15)	0 = ch.1 15 = ch.16	
kk = Control number	: 00H - 5FH (0 - 95)		
vv = Value	: 00H - 7FH (0 - 127)		

● Program change

Status	Second		
CnH	ppH		
n = MIDI channel number	: 0H - FH (0 - 15)	0 = ch.1 15 = ch.16	
pp = Program number	: 00H - 7FH (0 - 127)		

● Channel Pressure

Status	Second		
DnH	vvH		
n = MIDI channel number	: 0H - FH (0 - 15)	0 = ch.1 15 = ch.16	
vv = Value	: 00H - 7FH (0 - 127)		

● Pitch bend change

Status	Second	Third	
EnH	mmH	llH	
n = MIDI channel number	: 0H - FH (0 - 15)	0 = ch.1 15 = ch.16	
mm, ll = Value	: 00H, 00H - 7FH, 7FH 0 - 16383 (-8192 - +8191)		

2. TRANSMITTED DATA (Sequencer section)

2.1 All memorized messages are transmitted on Playing

2.2 All received messages are transmitted when SOFT THRU is ON.

2.3 Created message

■ System Common Message

● Song position pointer

Status	Second	Third	
F2H	mmH	llH	
ll, mm = Value	: 00H, 00H - 7FH, 7FH	0 - 16383	

* When SYNC TRANSMIT SWITCH is set at ON.

● Song select

Status	Second	
F3H	ssH	
ss = Value	: 0H - 13H (song 1 - 20)	

* When SYNC TRANSMIT SWITCH is set at ON.

■ System Real time message

● Timing clock

Status	
F8H	
* When SYNC TRANSMIT SWITCH is set at ON.	

● Start

Status	
FAH	
* When SYNC TRANSMIT SWITCH is set at ON.	

● Continue

Status	
FBH	
* When SYNC TRANSMIT SWITCH is set at ON.	

● Stop

Status	
FCH	
* When SYNC TRANSMIT SWITCH is set at ON.	

● Active Sensing

Status	
FEH	
* When ACTIVE SENSING TRANSMIT SWITCH is set at ON.	

3. RECOGNIZED DATA (Internal voice section)

■ Channel Voice Message

● Note off

Status	Second	Third	
BnH	kkH	vvH	
BnH	kkH	00H	
n = MIDI channel number	: 0H - FH (0 - 15)	0 = ch.1 15 = ch.16	
kk = Note number	: 0CH - 7BH (12 - 120)		
vv = velocity	: ignored		

● Note on

Status	Second	Third	
BnH	kkH	vvH	
n = MIDI channel number	: 0H - FH (0 - 15)	0 = ch.1 15 = ch.16	
kk = Note number	: 0CH - 7BH (12 - 120)		
vv = Velocity	: 01H - 7FH (1 - 127)		

● Control change

Status	Second	Third	
BnH	kkH	vvH	
n = MIDI channel number	: 0H - FH (0 - 15)	0 = ch.1 15 = ch.16	
kk = Control number	: 01H,02H,07H,40H (1,2,7,64)		
vv = Value	: 00H - 7FH (0 - 127)		

● Data entry (Bend range)

Status	Second	Third	
BnH	65H	00H	
BnH	64H	00H	
BnH	25H	mmH	
BnH	06H	llH	
n = MIDI channel number	: 0H - FH (0 - 15)	0 = ch.1 15 = ch.16	
mm, ll = Value	: 00H,00H - 00H,0CH (0 - 12)		

● Program change

Status	Second		
CnH	ppH		
n = MIDI channel number	: 0H - FH (0 - 15)	0 = ch.1 15 = ch.16	
pp = Program number	: 00H - 7FH (0 - 127)		

● Channel Pressure

Status	Second		
DnH	vvH		
n = MIDI channel number	: 0H - FH (0 - 15)	0 = ch.1 15 = ch.16	
vv = Value	: 00H - 7FH (0 - 127)		

● Pitch bend change

Status	Second	Third	
EnH	mmH	llH	
n = MIDI channel number	: 0H - FH (0 - 15)	0 = ch.1 15 = ch.16	
mm, ll = Value	: 00H,00H - 7FH,7FH 0 - 16383 (-8192 - +8191)		

■ Channel Mode Message

● All Notes off

Status	Second	Third	
BnH	7BH	00H	
n = MIDI channel number	: 0H - FH (0 - 15)	0 = ch.1 15 = ch.16	

*When W-30 receives this message, it process Note off for received notes remains on.

● OMNI OFF

Status	Second	Third	
BnH	7CH	00H	
n = MIDI channel number	: 0H - FH (0 - 15)	0 = ch.1 15 = ch.16	

* Recognized only as All Notes off.

● OMNI ON

Status	Second	Third	
BnH	7DH	00H	
n = MIDI channel number	: 0H - FH (0 - 15)	0 = ch.1 15 = ch.16	

* Recognized only as All Notes off.

● MONO

Status	Second	Third	
BnH	7EH	mmH	
n = MIDI channel number	: 0H - FH (0 - 15)	0 = ch.1 15 = ch.16	
mm = Number of MIDI channel	: ignored		

* Recognized only as All Notes off.

● POLY

Status	Second	Third	
BnH	7FH	00H	
n = MIDI channel number	: 0H - FH (0 - 15)	0 = ch.1 15 = ch.16	

* Recognized only as All Notes off.

4. RECOGNIZED DATA (Internal voice section)

4.1 Memorized messages while in RECORD mode

■ Channel Voice Message

● Note off

Status	Second	Third	
BnH	kkH	vvH	
BnH	kkH	00H	
n = MIDI channel number	: 0H - FH (0 - 15)	0 = ch.1 15 = ch.16	
kk = Note number	: 00H - 7FH (0 - 127)		
vv = velocity	: ignored		

● Note on

Status	Second	Third	
BnH	kkH	vvH	
n = MIDI channel number	: 0H - FH (0 - 15)	0 = ch.1 15 = ch.16	
kk = Note number	: 00H - 7FH (0 - 127)		
vv = Velocity	: 01H - 7FH (1 - 127)		

● Polyphonic Key Pressure

Status	Second	Third	
AnH	kkH	vvH	
n = MIDI channel number	: 0H - FH (0 - 15)	0 = ch.1 15 = ch.16	
kk = Note number	: 00H - 7FH (0 - 127)		
vv = Value	: 00H - 7FH (0 - 127)		

● Control change

Status	Second	Third	
BnH	kkH	vvH	
n = MIDI channel number	: 0H - FH (0 - 15)	0 = ch.1 15 = ch.16	
kk = Control number	: 00H - 7BH (0 - 120)		
vv = Value	: 00H - 7FH (0 - 127)		

● Program change

Status	Second		
CnH	ppH		
n = MIDI channel number	: 0H - FH (0 - 15)	0 = ch.1 15 = ch.16	
pp = Program number	: 00H - 7FH (0 - 127)		

● Channel Pressure

<u>Status</u>	<u>Second</u>		
DnH	vvH		
n = MIDI channel number	: 0H - FH (0 - 15)	0 = ch.1	15 = ch.16
vv = Value	: 00H - 7FH (0 - 127)		

● Pitch bend change

<u>Status</u>	<u>Second</u>	<u>Third</u>	
EnH	mmH	llH	
n = MIDI channel number	: 0H - FH (0 - 15)	0 = ch.1	15 = ch.16
mm, ll = Value	: 00H, 00H - 7FH, 7FH	0 - 16383	(- 8192 - + 8191)

■ Channel Mode Message

● Local On/Off

<u>Status</u>	<u>Second</u>	<u>Third</u>	
BnH	7AH	vvH	
n = MIDI channel number	: 0H - FH (0 - 15)	0 = ch.1	15 = ch.16
vv = Value	: 00H - 7FH (0 - 127)		

■ System Exclusive Message

<u>Status</u>	<u>Date_Byte</u>	
F0H	iiH, ddH, ..., eeH	
F7H		
F0	: System Exclusive	
ii = ID number	: 00H - 7FH (0 - 127)	
dd, ..., ee = Data	: 00H - 7FH (0 - 127)	
F7	: EOx (End of Exclusive)	

4.2 Recognized only

■ Channel Mode Message

● All Notes off

<u>Status</u>	<u>Second</u>	<u>Third</u>	
BnH	7BH	00H	
n = MIDI channel number	: 0H - FH (0 - 15)	0 = ch.1	15 = ch.16
* When W - 30 receives this message, it produces Note off message for received notes remains on.			

● OMNI OFF

<u>Status</u>	<u>Second</u>	<u>Third</u>	
BnH	7CH	00H	
n = MIDI channel number	: 0H - FH (0 - 15)	0 = ch.1	15 = ch.16
* Recognized only as All Notes off.			

● OMNI ON

<u>Status</u>	<u>Second</u>	<u>Third</u>	
BnH	7DH	00H	
n = MIDI channel number	: 0H - FH (0 - 15)	0 = ch.1	15 = ch.16
* Recognized only as All Notes off.			

● MONO

<u>Status</u>	<u>Second</u>	<u>Third</u>	
BnH	7EH	mmH	
n = MIDI channel number	: 0H - FH (0 - 15)	0 = ch.1	15 = ch.16
mm = Number of MIDI channel	: ignored		
* Recognized only as All Notes off.			

● POLY

<u>Status</u>	<u>Second</u>	<u>Third</u>	
BnH	7FH	00H	
n = MIDI channel number	: 0H - FH (0 - 15)	0 = ch.1	15 = ch.16
* Recognized only as All Notes off.			

4.3 Recognized messages for sync.

* When SYNC CLOCK is set at EXT.

■ System Common Message

● Song position pointer

<u>Status</u>	<u>Second</u>	<u>Third</u>	
F2H	mmH	llH	
ll, mm = Value	: 00H, 00H - 7FH, 7FH	0 - 16383	

● Song select

<u>Status</u>	<u>Second</u>	
F3H	ssH	
ss = Value	: 00H - 13H	0 - 19

■ System Realtime Message

● Timing clock

<u>Status</u>
F8H

● Start

<u>Status</u>
FAH

● Continue

<u>Status</u>
FBH

● Stop

<u>Status</u>
FCH

4.4 Message received for detecting trouble in MIDI connection

■ System Realtime Message

● Active sensing

<u>Status</u>
FEH

SPECIFICATIONS

W-30 : Music Workstation

Maximum simultaneously producible voices
16

■ Sound Source

DI Process

■ Sound Memory

● Internal

RAM Wave Data (rewritable) : 512K word
ROM Wave Data (not rewritable) : 512K word
RAM Wave-using Tones : 32/Tone Parameters
ROM Wave-using Tones : 64/Tone Parameters
Patches : 16/Patch Parameters
FUNC Parameters
MIDI Parameters

● System Disk

ROM Wave-using Tones : 128/Tone Parameters
ROM Wave-using Patches : 32/Patch Parameters

● Sound & Song Disk

Wave Data : 512K word
RAM Wave-using : Tones : 32/Tone Parameters
ROM Wave-using : Tones : 64/Tone Parameters
Patches : 16/Patch Parameters
FUNC Parameters
MIDI Parameters

■ Song Memory

● Internal

Number of Songs : 20 max.
Number of Steps : Max. of approx. 15,000 steps
(20 song total)

● Song Disk

Number of Songs : 64 max.
Number of Steps : Max. of approx. 100,000
steps (64 song total)

● Sound & Song Disk

Number of Songs : 64 max.
Number of Steps : Max. of approx. 7,000 steps
(64 song total)

Editing Functions : Track, measure, and event
basis

Resolution : 96 clock pulses/quarter note
External

Synchronization : MIDI Sync Clock, Song Select,
Start, Stop, Continue, and Song
Position Pointer compatible

Song Data Length : Max. of 9,998 measures

● Tracks

Phrase Tracks (16 MIDI Channels/Tracks) : 16
Tempo Track : 1

● Maximum simultaneously inputable sounds

128 (Total for all tracks)

● Maximum simultaneously outputable sounds

128 (Total for all tracks)

■ Keyboard

61 Keys (Aftertouch equipped)

■ Panel

Bender Modulation Lever
Volume Knob
Performance Button
Sequencer Button
Sound Button
Start/Stop Button
REC Button
Tempo Button
Skip Button
Forward/Reverse Button
LCD Display
User Button
Function Buttons ([F1] - [F5])
EXIT Button
Numerical Keypad
Cursor Dial
Value Dial

■ Rear Panel

Power Switch
Headphone Socket
Multi Output Sockets × 8
Input Socket
Gain Knob
MIDI Sockets (THRU, OUT, IN)
Pedal Control Socket (DP-2, EV-5)
SCSI Connector (Compatible with the SCSI Standard)
Contrast Knob

■ Disk Drive

3.5 Inch Micro Floppy Disk Drive
Storage Type :Double Sided, Double Density,
Double Track

■ Dimensions

1,014 (W) × 301 (D) × 106 (H) mm
39 - 15/16" × 11 - 7/8" × 4 - 3/16"

■ Weight

9.8Kg

■ Power Consumption

18W

■ Accessories

Owner's Manual for FD
Mode Chart for FD
Sound Chart
MIDI Guide Book
System Disk for FD
Data Disk × 3

Connecting Cable PJ-1 × 1

■ Options

DP-2 Pedal Switch
EV-5 Expression Pedal
KW-30 (W-30 Upgradekit)
MF2-DD 3.5 Inch Micro Floppy Disks
CD-5 CD-ROM Player

*Specifications are subject to change without notice, in the interest of improvement.

Index

Important Notes

Concerning placement	7
Concerning the power supply	7
Handling of disks	7
Maintenance	7
Other Precautions	7

Basic Procedures

Changing Values	49
Command	48
Display Layout	45
Entering Names	49
EXIT Button	48
Function Keys	48
Jump the to the screen number you have specified	47
Menu	46
Mode Buttons	45
Move th Cursor	49
Registering frequently used screens	47
Numerical Keypad	49
Sub-windows	48
Screen Selection	45

Playing the W-30

Aftertouch	15
Bender	16, 25, 86, 96
Bender Modulation Lever	15
Changing Patches	14
Channel Aftertouch	15, 25, 86, 96
Connections	10
Local on/off	37, 110
Master Tuning	16
Performance Play	14
Playing along with the song	18
Power-up and booting up	12
Program Changes	56, 57
Sequencer Play	17
Song Play	18, 50
Using the Breath Controlller	37, 112
Velocity	15, 25, 31

Connections

Amplifier Setup	10
Connecting needed for sampling	77
Headphone Connection	10
Mixer Setup	10
Setup using Radio Cassette Recorder, etc.	10

Memory

Address	71
Backing up the System Disk	13
CD-5	11
Checking the amount of wave space left	69
Compatible Disks	41
Copy the Floppy Disks	107, 137
Data Disk	11, 17, 39, 40
Disk Capacity	40
Disks Supplied	11
Floppy Disk	7, 13
Formatting the disk	41, 106
Hard Disks	11
Internal Memory	38
Load	17, 39, 72
Loading Song and Sound Data	17, 39, 72
Loading Sound Data	72
Loading Tone Parameters	73
Loading Tone Parameters with a Wave	73
Loading a Tone from a Data Disk	73
Loading Patch Parameters	73
Loading Patch with Tones	73
Loading a Patch from a Data Disk	73
Loading a Patch from a System Disk	73
Loading a Tone from a System Disk	73
Memory Capacity for Song Data	23
Protect tab	41
Remaining Time	69
Sound & Song Disk	40, 106
Save	41, 98
Saving System Configuration Data	106
Table of Data saved onto disks	184
Song Disk	40, 106
System	37
System Data	37
System Configurations	37, 106, 110, 111
System Disk	11, 12, 13, 37, 38, 40
Utility Sistem	40

Song

Sequencer	21
Beats	23, 25, 83
Check of the Song Data	97
Clock	24, 25
Difference between a Sequencer and a Multi-track Recorder	21
Feature of a Sequencer	21
How to use a sequencer	22

Measure	24, 25
Metronome	82
M/B/C	25, 92, 93
Locate Point	90, 118
Note Numbers	25, 96
Sequencer Mode	44
Song Parameters	184
Status	92, 96
Step	23
Song Playing	17, 18, 50
Song data	21
FUNC Data	39
Memory Capacity for Song Data	23
Tempo	
Changing the Tempo	18, 25, 94
Standard Tempo	23, 82, 94
Tempo Track	22, 23
Writing Tempo Change	94
Tracks	22
Phrase Tracks	22, 23
Tempo Track	22, 23
Track Indication	24, 97
Track Parameters	86, 117
Recording	22, 81, 88
Auto Punch IN/OUT Recording	88, 115
Auto Punch IN Recording	88, 115
Auto Punch OUT Recording	89, 115
Key On Recording	84, 87, 88, 115
Loop Recording	89, 115
Manual Punch IN/OUT Recording	89, 115
Normal Recording	84, 87, 88, 115
Dubbing over	21, 81
Keyboard Channel	84
Locate Points	90, 118
Metronome	82
New Measure Beat	83
Number of the measure where recording should start	82
Oncave Shift of the Keyboard	84
Preparing a sound	81
REC Start Point	88, 90
REC end Point	88, 90
Recording Gate Time	85, 116
Recording Mode	84, 88, 115

Recording next Track	91
Recording Parameters	85, 116
Re-recording portions of data	88
Recording Quantize	85, 116
Recording Switches	86, 117
Recording track	83
Send the Program Changes	84
Sync Clock	82
Song Selection	82
Standard Tempo	82
Tempo (J =)	82
Users PointS	90

Micro Edit	24
Checksum	118
Events	24, 25, 92, 96
Event Indication	25
Location of Events	24, 93
Score and data	25
To scroll the screen	93
Writing Tempo Change	94

Song Editing	95
Change Gate Time	133
Change MIDI Ch	132
Change Velocity	131
Copy	122
Delete Measure	126
Erase	119
Extract	129
Insert Measure	126
Merge	121
Quantize	125
Shift Clock	134
Track Exchange	135
Transpose	130

Sound Module

Samplers	26
Differential Interpolation	27
Fixed sampling method	27
PCM	26
Roland's DI System	27
Sampling Frequency	26, 78
Sound Mode	44

Sound Data	26	Sampling	26, 77
Block	38, 72	Checking Input Level	79
Contents of Sound Data	28	Connections needed for sampling	77
FUNC	38, 39, 72	Executing Sampling	80
MIDI	38, 72	Original Key	79
Set	38, 72	Pre-trigger	79
Tone	28, 61, 68	Sampling Frequency	26, 78
Delete a Tone	69	Sampling Time	78
Distinguishing Tone Types	68	Sampling Standby Mode	79
Making a Sub-tone	61	Auto Sampling	79, 80
New Waves can no longer be written	68	Manual Sampling	80
Original Tones	30, 61, 68	Previous Sampling	80
ROM tone	61, 68	15KHz Sampling	26, 78
Sub-tones	30, 61, 68	30KHz Sampling	26, 78
Tone List	61	Patches	31
Tone Parameters	28	Assign Tones to a Patch	58
Tone Play	35	Change Patches	56, 57
1st tone	58, 59	Changing sounds depending on	
2nd tone	58, 59	how you play the keyboard	31
Tone Parameters	28	Confirming Tone Set	58, 59
Auto Loop	64, 152	Key Mode	31, 59
Checking Split Set	58	Making a Patch	58
Editing Tone Parameters	60	Patch List	14
End point	63, 71	Patch Parameters	32, 58
Start point	63, 71	Patch Playing	35
LFO	62	Split	31, 58
Loop	63, 151	1st tone	58, 59
loop Mode	63	2nd tone	58, 59
Loop Point	63, 71	Parts	32
TVA	52, 60, 62	Change the Number of Voices of each Part	54
TVF	60, 62	Output Mode	10, 53
Wave Data	28, 29	Multi Timbre	32
Address	71	Understanding Parts	33
Delete a tone	69	Voice Mode	54
New Waves can no longer be written	68	Change Volume	52
Non-rewritable Wave Data	29	Change Output Sockets	53
Rewritable Wave Data	29	Change Pitches	55
Segment	29, 78	Pedal Assignment	
Wave Banks	29, 78	DP - 2 (FS - 5U)	99, 111
Wave Display	66	EV - 5 (EV - 10)	99, 112
Remaining Time	69		
ROM Waves A/B	29		
Editing Wave Data	70		
Smoothing	64, 173		

Using Data Created on other models

MRC - 300	41, 100
MRC - 500	41, 100
S - 330	41, 100, 101
S - 50 (Ver1.0/2.0)	41, 100, 101
S - 550	41, 100, 101
SUPER - MRC	41, 100, 101
SYS - 333	41, 100
SYS - 503	41, 100
SYS - 503 Type A	100, 101
SYS - 553	41, 100

MIDI

Active Sensing	111
Empoling MIDI OUT and MIDI IN	34
Exclusive	25, 118, 192, 194
Checksum	118, 195
Clock (MIDI)	104, 105, 111
Continue (MIDI)	111
Contorol Changes	25, 86, 96
MIDI Implementation	196
MIDI Sinc	104
Sinc Recording	105
Song Position Pointer	104, 111
Song Select	104, 111
Start (MIDI)	104, 105, 111
Soft Thru	37, 103, 111
Stop (MIDI)	104, 105, 111
Tune Request	25, 86, 96
Using External MIDI Devices	102

NOTES

Roland®

10492

UPC

10492



1996

Roland®