

# Panasonic

## KEYBOARD

# SX-MB100



Before connecting, operating or adjusting this product, please read these instructions completely. Please keep this manual for future reference.



## Dear customer

Thank you for purchasing this product.  
For optimum performance and safety, please read  
these instructions carefully.

## Table of contents

### BASIC FUNCTIONS

PRECAUTIONS.....	5
Getting started .....	6
Modes .....	7
Controls and functions .....	8
Listen to a CD.....	10
Performing with a CD (remix play) .....	12
Beat Master .....	14
Listen to the FM radio.....	17

### PRACTICAL APPLICATIONS

Selecting sounds .....	18
Tuning .....	19
Transpose .....	19
Selecting rhythms .....	20
Automatic CD tempo detection .....	22
Changing the CD playback mode .....	23
Automatic Accompaniment .....	24
Storing FM station settings.....	26
Other Settings .....	27
Connection terminals and optional accessories..	30
Symptoms which appear to be signs of trouble ....	31
Error messages.....	32
Index .....	33
Specifications .....	34

#### ■ Supplied accessory

Please check the supplied accessory.



- Music stand
- AC adaptor
- Remix Demo CD

**Note:** The included AC adaptor is for use with  
this unit only. Do not use it with other equipment.

BEFORE YOU PLAY, PLEASE READ THE CAUTIONARY COPY APPEARING ON PAGE 5.

**CAUTION:**

This equipment has been tested and found to comply with the limits for a Class B digital device, pursuant to Part 15 of the FCC Rules. These limits are designed to provide reasonable protection against harmful interference in a residential installation. This equipment generates, uses and can radiate radio frequency energy and, if not installed and used in accordance with the instructions, may cause harmful interference to radio communications. However, there is no guarantee that interference will not occur in a particular installation. If this equipment does cause harmful interference to radio or television reception, which can be determined by turning the equipment off and on, the user is encouraged to try to correct the interference by one of the following measures:

- Reorient or relocate the receiving antenna.
- Increase the separation between the equipment and receiver.
- Connect the equipment into an outlet on a circuit different from that to which the receiver is connected.
- Consult the dealer or an experienced radio/TV technician for help.

Any unauthorized changes or modifications to this equipment would void the user's authority to operate this device.

This device complies with Part 15 of the FCC Rules. Operation is subject to the following two conditions: (1) This device may not cause harmful interference, and (2) this device must accept any interference received, including interference that may cause undesired operation.

**CAUTION!**

**THIS PRODUCT UTILIZES A LASER. USE OF CONTROLS OR ADJUSTMENTS OR PERFORMANCE OF PROCEDURES OTHER THAN THOSE SPECIFIED HEREIN MAY RESULT IN HAZARDOUS RADIATION EXPOSURE. DO NOT OPEN COVERS AND DO NOT REPAIR YOURSELF. REFER SERVICING TO QUALIFIED PERSONNEL.**

**WARNING:**

**TO REDUCE THE RISK OF FIRE, ELECTRIC SHOCK OR PRODUCT DAMAGE, DO NOT EXPOSE THIS APPLIANCE TO RAIN, SPLASHING, DRIPPING OR MOISTURE.**

The model number and serial number are found underneath the keyboard. Please note the model and serial numbers in the space provided below and retain this sheet as a permanent record of your purchase to aid identification in the event of theft.

MODEL NUMBER \_\_\_\_\_

SERIAL NUMBER \_\_\_\_\_

# Panasonic

## OWNER'S MANUAL

### Before you play

For long and pleasurable use of this instrument, and to gain a thorough understanding of your **MB100** Keyboard, it is strongly recommended that you read through this Owner's Manual once.

The Owner's Manual is comprised of the following parts.

#### **BASIC FUNCTIONS**

This part includes an explanation of basic procedures and points you should be aware of for proper operation of your instrument.

#### **PRACTICAL APPLICATIONS**

This part comprises a detailed explanation of sound, rhythm, CD player, FM tuner and Setting functions.

#### **REFERENCE GUIDE** (separate booklet)

Reference guide for the contents of the Sound and Rhythm List, "Remix Demo CD", MIDI Implementation Chart.

- This product may receive radio interference caused by Mobile telephone during use. If such interference is apparent, please increase separation between the product and Mobile telephone.

# PRECAUTIONS

Before using this unit please read these operating instructions carefully.

Take special care to follow the warnings indicated on the unit itself as well as the safety suggestions listed below.

Afterwards keep them handy for future reference.

## Safety

- 1. Power Source**—The unit should be connected to power supply only of the type described in the operating instructions or as marked on the unit.
- 2. Polarization**—If the unit is equipped with a polarized AC power plug (a plug having one blade wider than the other), that plug will fit into the AC outlet only one way. This is a safety feature. If you are unable to insert the plug fully into the outlet, try reversing the plug. If the plug should still fail to fit, contact your electrician to replace your obsolete outlet. Do not defeat the safety purpose of the polarized plug.
- 3. Power Cord Protection**—AC power supply cords should be routed so that they are not likely to be walked on or pinched by items placed upon or against them. Never take hold of the plug or cord if your hand is wet, and always grasp the plug body when connecting or disconnecting it.
- 4. Nonuse Periods**—When the unit is not used, turn the power off. When left unused for a long period of time, the unit should be unplugged from the household AC outlet.

## Installation

### Environment

- 1. Water and Moisture**—Do not use this unit near water, for example, near a bathtub, washbowl, swimming pool, or the like.  
Damp basements should also be avoided.
- 2. Condensation**—Moisture may form on the lens in the following condition...
  - immediately after a heater has been turned on.
  - in a steamy or very humid room.
  - when the unit is suddenly moved from a cold environment to a warm one.If moisture forms inside this unit, it may not operate properly. To correct this problem, turn on the power and wait about one hour for the moisture to evaporate.
- 3. Heat**—The unit should be situated away from heat sources such as radiators and the like. It also should not be placed in temperatures less than 5°C or greater than 35°C (95°F).

### Placement

- 1. Ventilation**—The unit should be situated so that its location or position does not interfere with its proper ventilation. Allow 10 cm (4") clearance from the rear of the unit.
- 2. Foreign Material**—Care should be taken so that objects do not fall into and liquids are not spilled into the unit. Do not subject this unit to excessive smoke, dust, mechanical vibration, or shock.
- 3. Magnetism**—The unit should be situated away from equipment or devices that generate strong magnetic fields.
- 4. Stacking**—Do not place heavy objects, other than system components, on top of the unit.
- 5. Surface**—Place the unit on a flat, level surface.
- 6. Carts and Stands**—The unit should be used only with a cart or stand that is recommended by the manufacturer. The unit and cart combination should be moved with care. Quick stops, excessive force, and uneven surfaces may cause the unit and cart combination to overturn.
- 7. Wall or Ceiling Mounting**—The unit should not be mounted to a wall or ceiling, unless specified in this operating instructions.



## Maintenance

Clean the cabinet, panel and controls with a soft cloth lightly moistened with mild detergent solution. Do not use any type of abrasive pad, scouring powder or solvent such as alcohol or benzine.

## Service

- 1. Damage Requiring Service.** The unit should be serviced by qualified service personnel when:
  - (a) The AC power supply cord or the plug has been damaged;
  - or
  - (b) Objects have fallen or liquid has been spilled into the unit; or
  - (c) The unit has been exposed to rain; or
  - (d) The unit does not appear to operate normally or exhibits a marked change in performance; or
  - (e) The unit has been dropped, or the enclosure damaged.
- 2. Servicing**—The user should not attempt to service the unit beyond that described in the operating instructions. All other servicing should be referred to an authorized service personnel.  
**For the address of an authorized servicenter:**  
**In the U.S.A., call 1-800-211-7262,**  
**e-mail: [consumerproducts@panasonic.com](mailto:consumerproducts@panasonic.com),**  
**or visit [www.panasonic.com](http://www.panasonic.com)**  
**In Canada, call 905-624-5505**  
**or visit [www.panasonic.ca](http://www.panasonic.ca)**

# Getting started

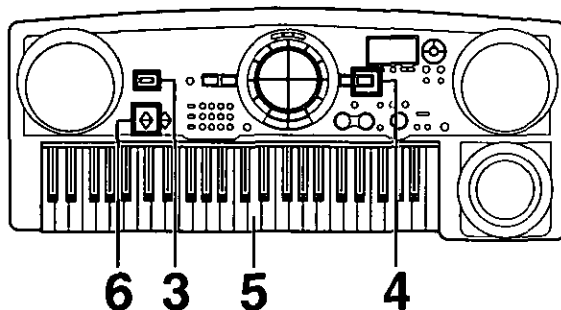

**1** Connect the AC adaptor (included).

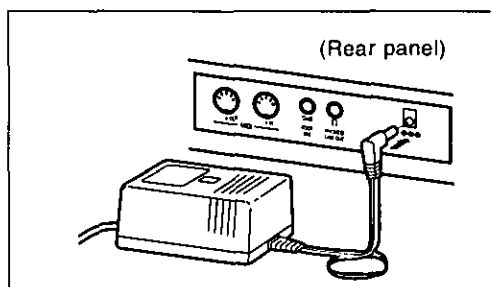

- Do not disconnect and connect the AC adaptor when the power button is on, as doing so may cause the the programmed settings and recorded contents to be deleted.

**2** Affix the music stand as shown.

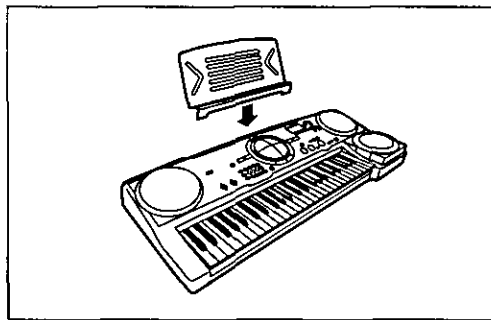

**3** Turn the power on.

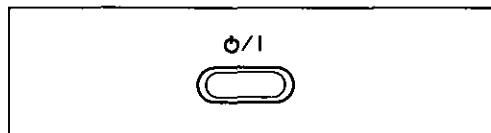

**4** Press the **CD & KEYBOARD** button to turn it on.

**5** Play the keyboard.

**6** Use the **KEYBOARD VOLUME** controls to adjust the volume (0 to 20).

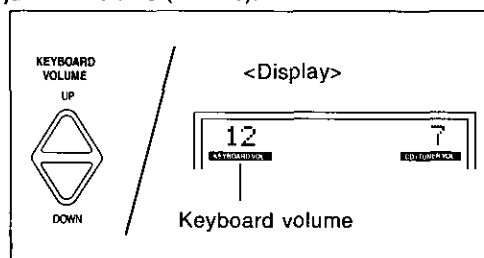

- After a few seconds, the display returns to the previous display.
- These buttons do not function when the **FM TUNER** mode is selected.

## ■ Light Show

If the power is left on and the soundless state continues for several minutes, the panel buttons flicker in a "light show".

### To turn off the light show

The light show can be disabled with the **MENU** function. (Refer to pages 27, 29.)

## ■ Memory function

The settings of this instrument are retained as long as the AC adaptor remains connected to an electrical outlet.

- The unit is in the standby condition when the AC adaptor is connected. The primary circuit is always "live" as long as the AC adaptor is connected to an electrical outlet.

- When leaving the product unused for a long time, turn off the power button of the unit and pull the AC adaptor out of the socket for power saving.

# Modes

This instrument has four operating modes, which are selected with the respective mode buttons.

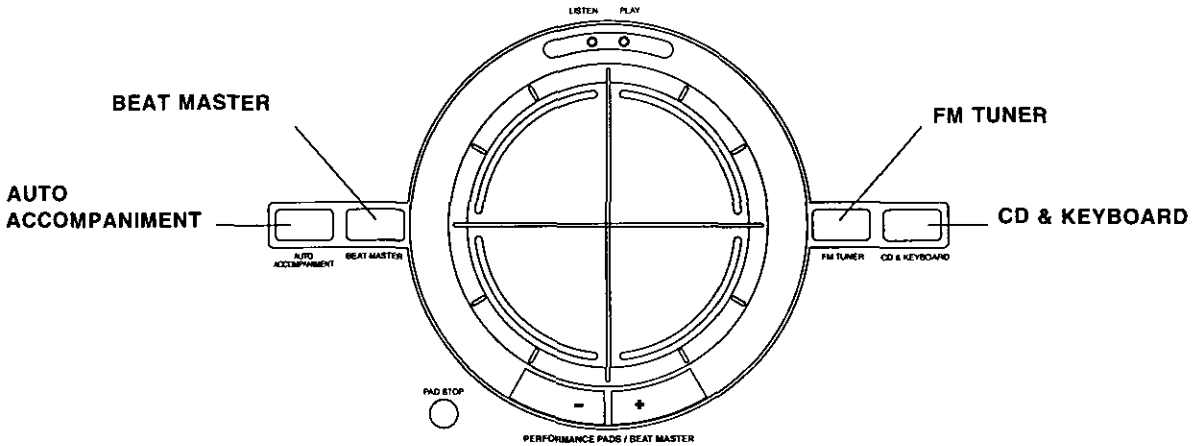

## ■ BEAT MASTER



Select this mode to play a game that uses the pad buttons. (Refer to page 14.)

## ■ AUTO ACCOMPANIMENT



This mode is for a performance that uses the automatic accompaniment function. (Refer to page 24.)

## ■ CD & KEYBOARD



The CD playback and keyboard performance mode. This mode is also for performing on the keyboard, rhythm and/or pad buttons while playing a CD (remix play). (Refer to pages 10, 12.)

- If you exit or switch to this mode during a rhythm or pad performance, the respective playback stops.

## ■ FM TUNER



Select this mode to listen to FM radio broadcasts. (Refer to page 17.)

- The keyboard keys and rhythm performance do not function when this mode is selected.

# Controls and functions

## AUTO ACCOMPANIMENT

An automatic accompaniment is added to your playing melody by your specifying a chord. (Refer to page 24.)

## BEAT MASTER

A fun way to develop your sense of rhythm. (Refer to page 14.)

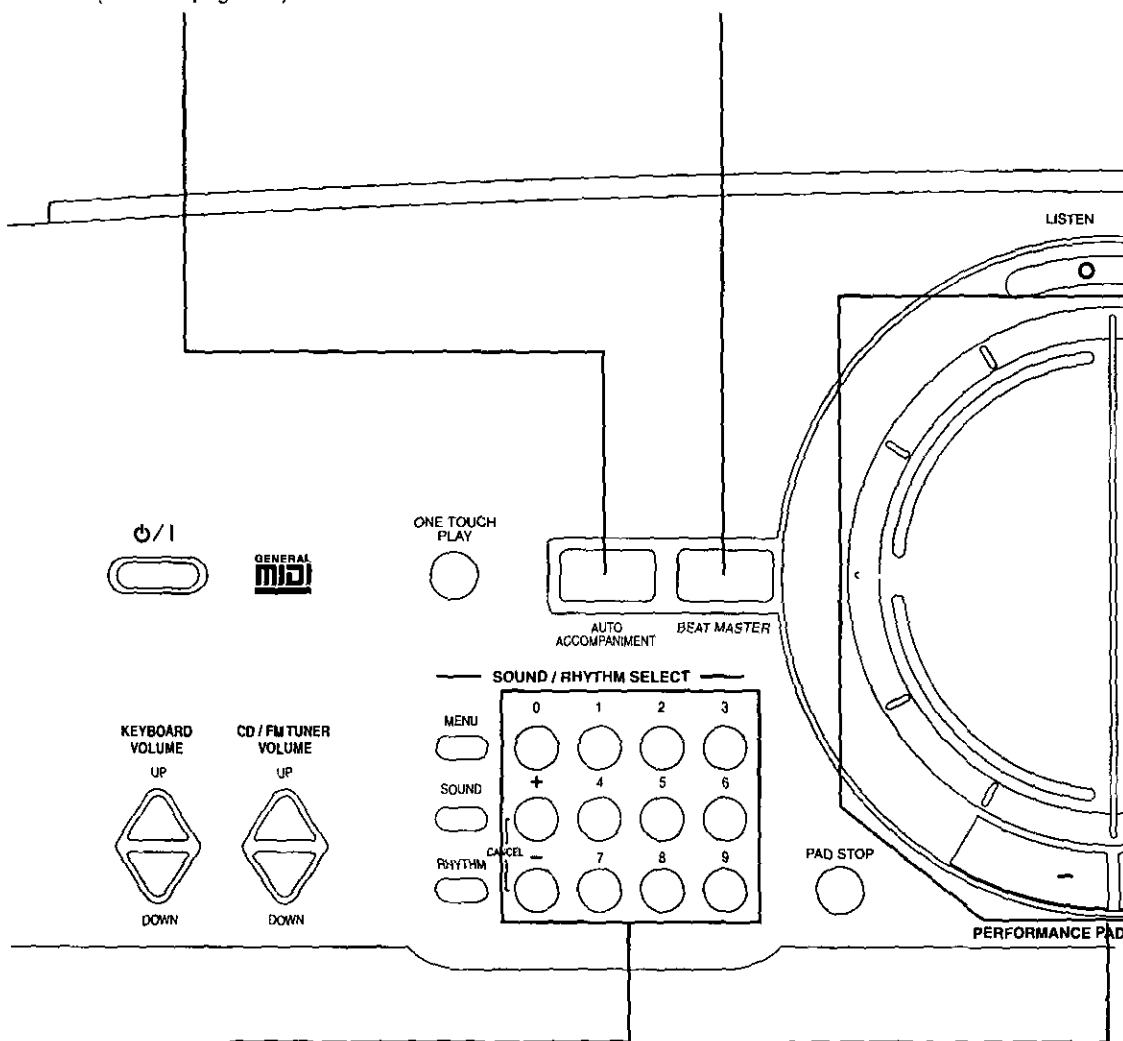

**Number buttons**  
Specify the desired sounds and rhythms by number.

**PERFORMANCE PADS**  
Just press a pad button to add a phrase to your playing. (Refer to page 13.)



### FM TUNER

You can listen to FM broadcasts.  
(Refer to page 17.)

### Display

The display shows the status of  
your instrument and is also used  
for setting the various functions.

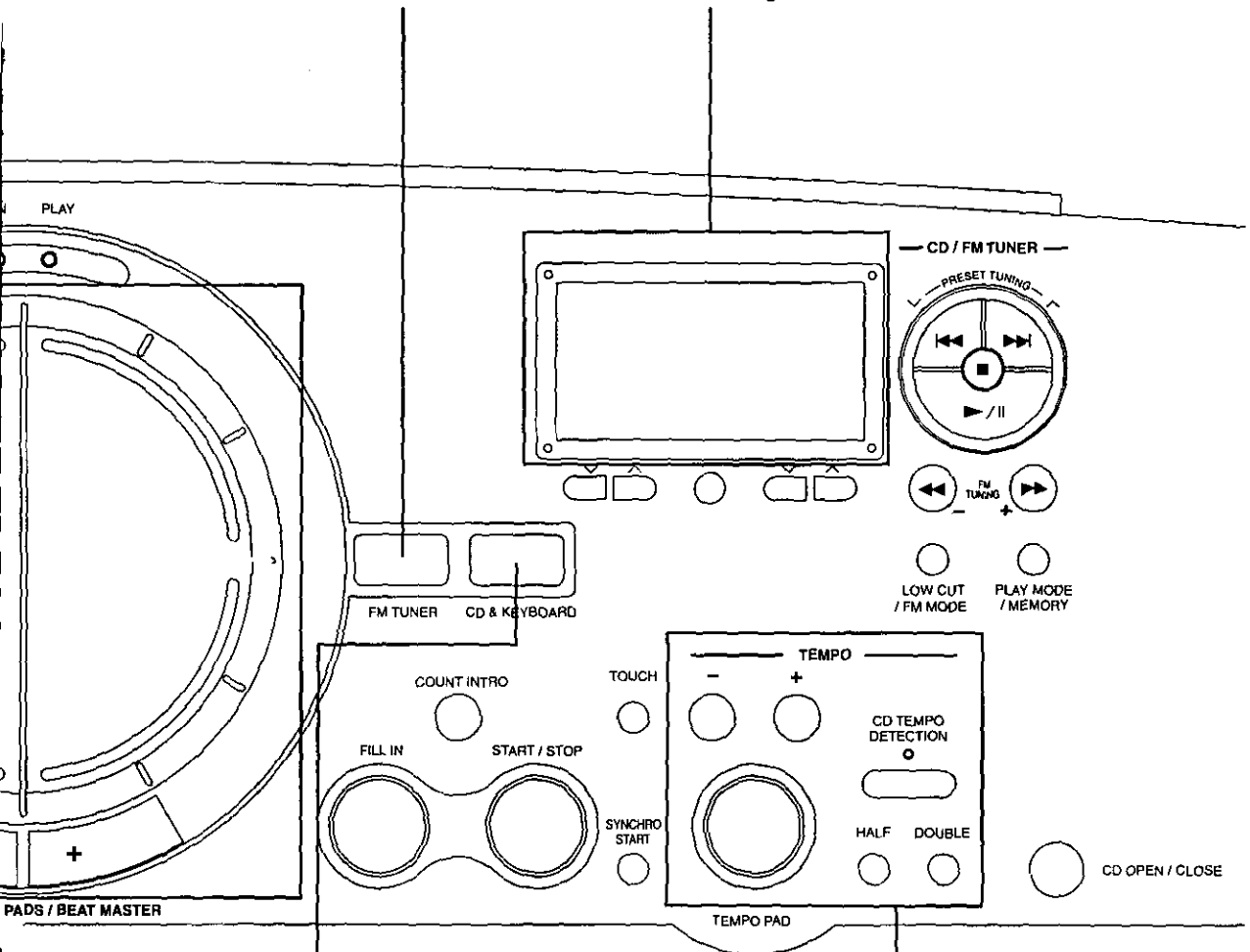

### CD & KEYBOARD

In addition to the normal keyboard  
performance and CD playback, you  
can perform while playing a CD  
(remix play) as well. (Refer to  
pages 10, 12.)

### TEMPO

These buttons in this section are  
used to adjust the tempo of the  
rhythm, and they are also used to  
automatically detect the tempo of a  
CD song. (Refer to pages 20, 22.)

# Listen to a CD

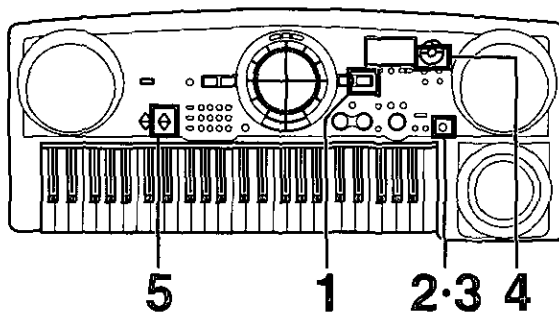

**1** Press the **CD & KEYBOARD** button to turn it on.

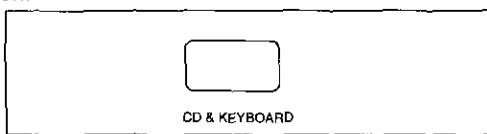

**2** Press the **CD OPEN/CLOSE** button to open the CD tray. Insert a CD in the tray.

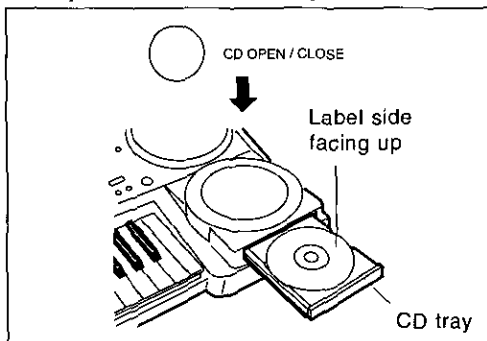

**3** Press the **CD OPEN/CLOSE** button again to close the CD tray.

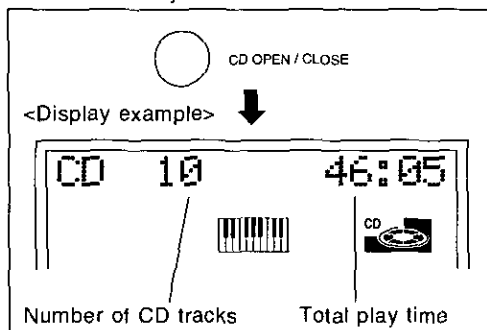

- "PLEASE WAIT!" is shown on the display while the CD information is being accessed.

**4** Press the **▶/||** button to begin playback.

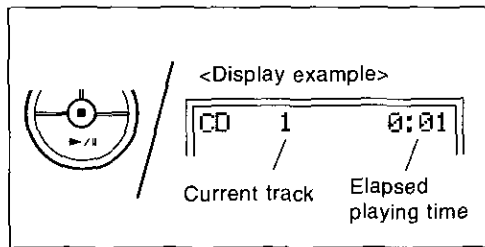

- The CD stops playing after the last track has played.

**5** Use the **CD/FM TUNER VOLUME** buttons to adjust the volume (0 to 20).

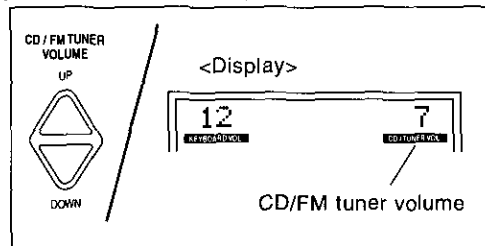

- After a few seconds, the display returns to the previous display.
- These buttons do not function when **BEAT MASTER** or **ACCOMPANIMENT** mode is selected.

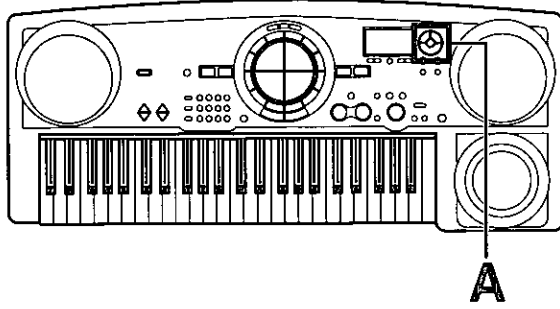

## A Playback operation

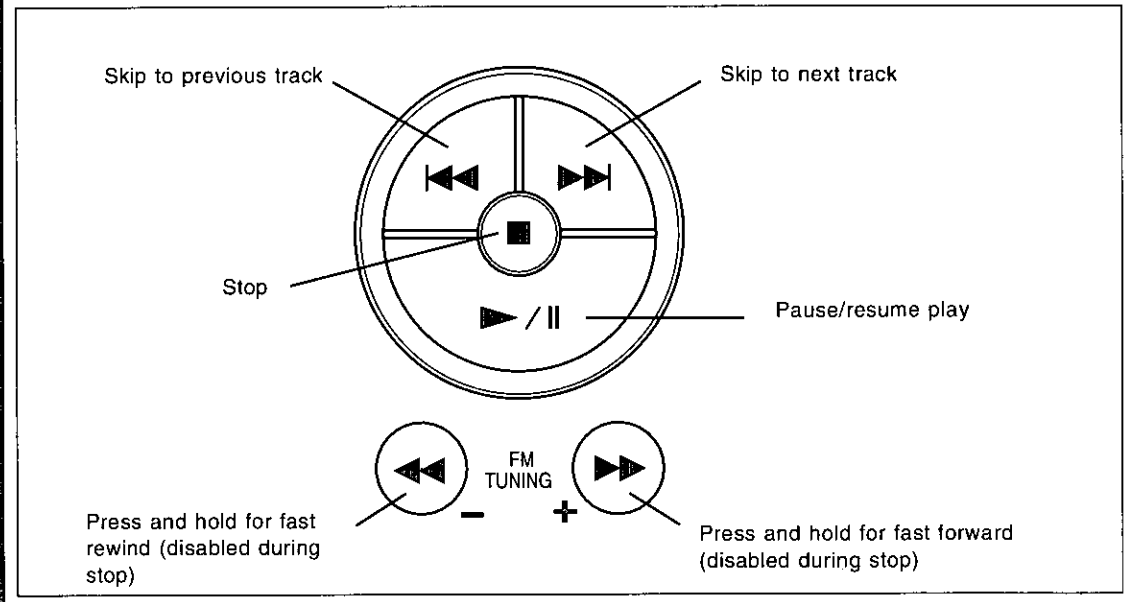

This unit can play CD-DA format audio CD-R and CD-RW that have been finalized\* upon completion of recording. It may not be able to play some CD-R or CD-RW due to the condition of the recording.

\* Finalizing is a process that enables CD-R/CD-RW players to play audio CD-R and CD-RW.

# Performing with a CD (remix play)

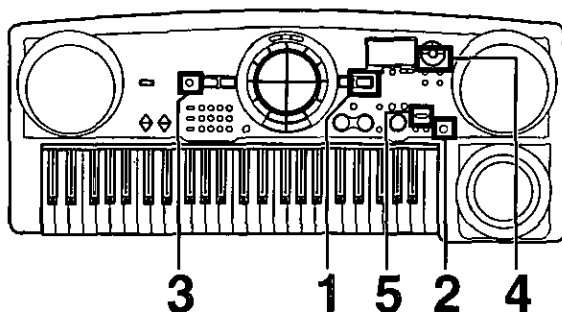

## Phrase remix

- 1** Press the **CD & KEYBOARD** button to turn it on.

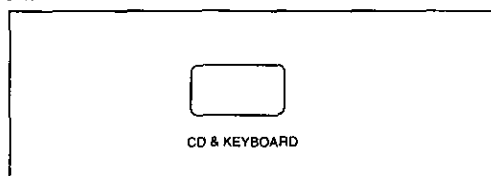

- 2** Press the **CD OPEN/CLOSE** button; insert the included "Remix Demo CD."  
**Song name list**

1	Fill The Groove
2	Fill The Groove (Remix with <b>MB100</b> )
3	We Haven't Got Bebap
4	We Haven't Got Bebap (Remix with <b>MB100</b> )
5	Say What?
6	Say What? (Remix with <b>MB100</b> )

- "Remix with **MB100**" in 2, 4 and 6 are remix examples. For remix play select 1, 3 or 5.

- 3** Press the **ONE TOUCH PLAY** button to select the settings for remix.
- There are three types of settings for remixing.

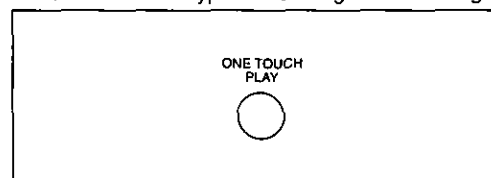

- Switch from one type to another by pressing the button. The name of the setting type is shown on the display.

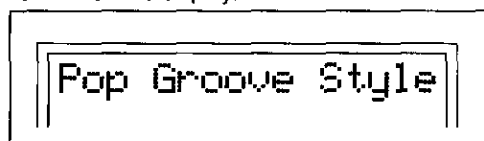

- For this example, select "Pop Groove Style."

- 4** Press the **▶/||** button to begin CD playback.

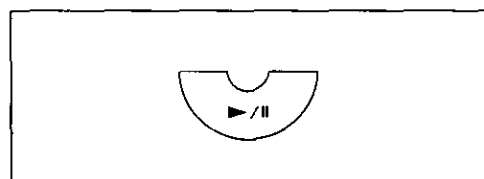

- For this example, play back the first song.

- 5** Press the **CD TEMPO DETECTION** button to turn it on.

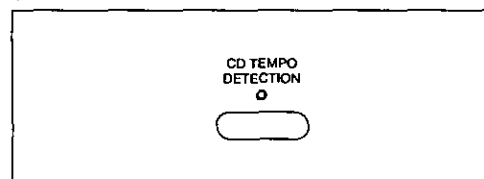

- The indicator flashes, and automatic tempo detection begins. When the CD tempo is detected, the four **PERFORMANCE PADS** flash in time with the detected tempo.

- Detailed information about the "Remix Demo CD" can be found in the separate Reference Guide provided.
- The tempo of other CDs can be detected, with exceptions depending on the particular song.

- For details about automatic tempo CD detection refer to page 22.
- The **ONE TOUCH PLAY** button has a different function when the auto accompaniment is active. (Refer to page 25.)

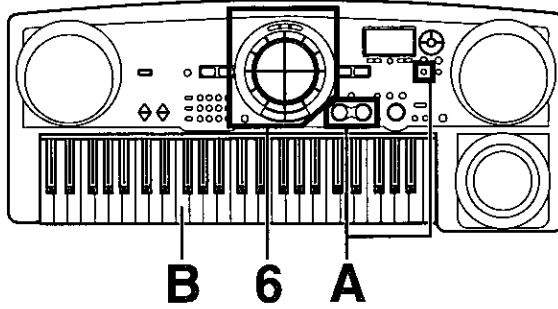

**6** Press the **PERFORMANCE PADS** in time with the beginning of each measure.

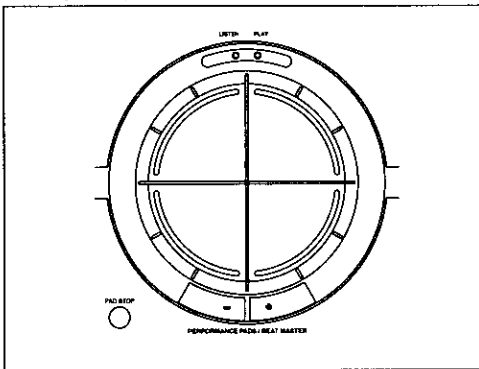

- A phrase will sound in the same tempo that was detected in the CD song.
- Each pad button produces a different phrase.
- Some phrases may be played repeatedly in a loop.
- When the **PAD STOP** button is pressed, phrase playback stops.
- You can use the + and - buttons below the pad buttons to switch to a different bank. (Refer to page 18.)

### Rhythm remix

**A** Start the rhythm playback by pressing the **START/STOP** button in time with the beginning of a measure.

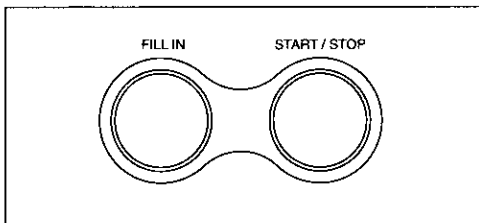

- If the **FILL IN** button is pressed, the pattern changes briefly.
- The rhythm stops when the **START/STOP** button is pressed again.
- You can also select the desired rhythm. (Refer to page 20.)

### ■ LOW CUT

If you wish to eliminate the lower range tones (drums, bass, etc.) from the CD playback sound, press the **LOW CUT** button to turn it on.

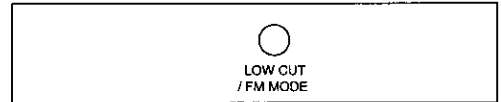

- When the **LOW CUT** button is on, **LOW CUT** is shown on the display.

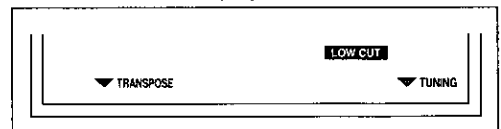

### Sound remix

**B** Play the keyboard in time with a song.

- You can also select the desired sounds. (Refer to page 18.)

- The CD volume can be adjusted with the **CD/FM TUNER VOLUME** buttons, and the rhythm pads and keyboard sound volumes can be adjusted with the **KEYBOARD VOLUME** buttons.

# Beat Master

**BEAT MASTER** is a function that helps develop your sense of rhythm while you enjoy playing.

This illustration shows how the **MB100** first models the beat, and then how you mimic it.

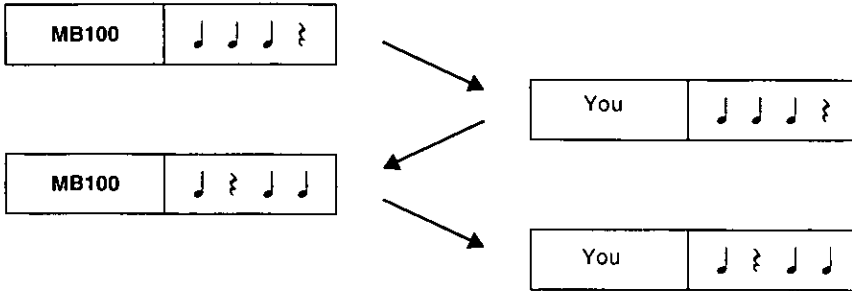

The 4 pad buttons in the middle of the panel are used for the game. As the instrument models the rhythm, the corresponding pad indicators light. Then it's your turn—use your fingers to try to tap the same pad buttons using the same timing. As you tap the pad buttons, the melody is played in time with your rhythm. It's almost like playing a duet with the **MB100**.

<MB100: LISTEN>

<You: PLAY>

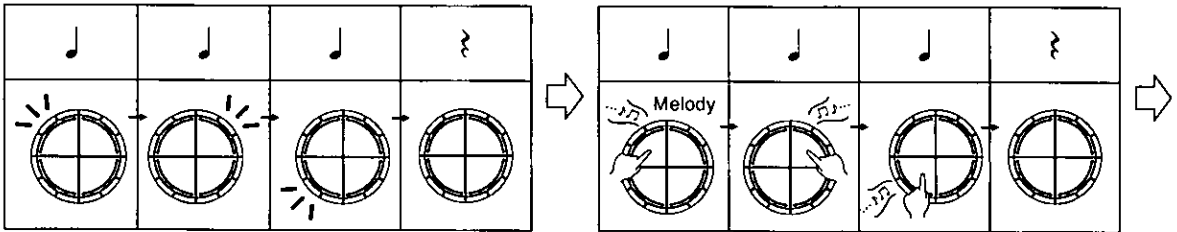

To learn how to use the **BEAT MASTER**, begin with the song "1:Warm Up". The structure of this song is shown below, so take a minute to look it over before starting the lesson (following).



Number: Pad number  
Note: Beat timing

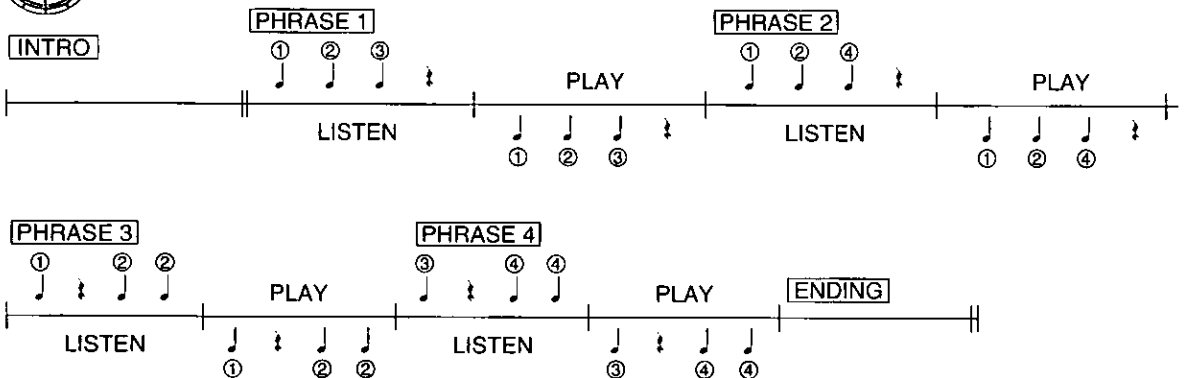

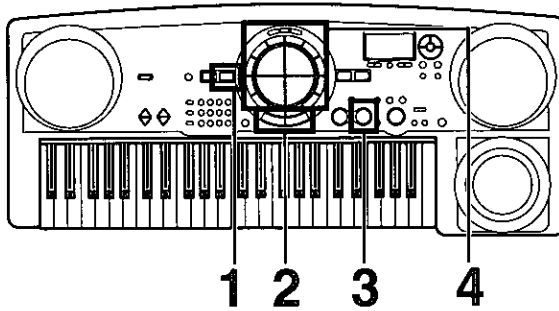

**1** Press the **BEAT MASTER** button to turn it on.

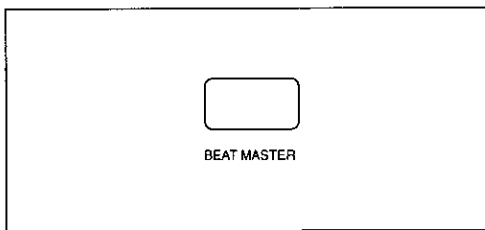

- The indicators for the pads light, and the BGM song plays.

**3** Press the **START/STOP** button.

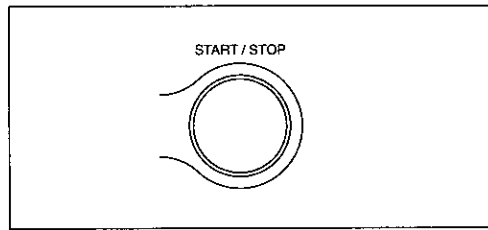

- The song begins to play.

**2** Use the **BEAT MASTER +** and **-** buttons to select a song number.

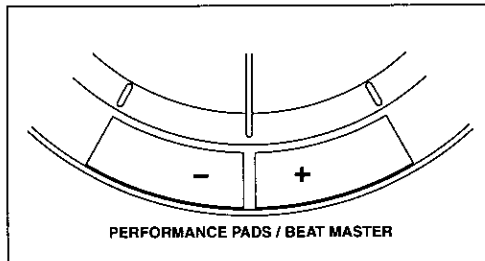

- Select a song number from 01 to 10. The higher the number, the more difficult the song.

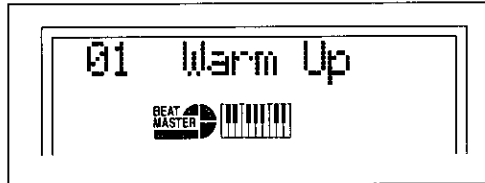

- You can also select the song number with the **VALUE** buttons, located below the display to the right.

**4** Confirm that the pad buttons light (**LISTEN**).

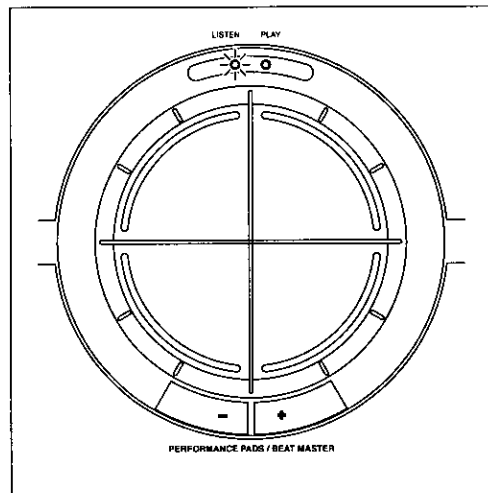

- Watch the timing of the pad indicators and try to remember it. While the **MB100** plays the model phrase, the **LISTEN** indicator is lit.

*(Continued on the next page)*

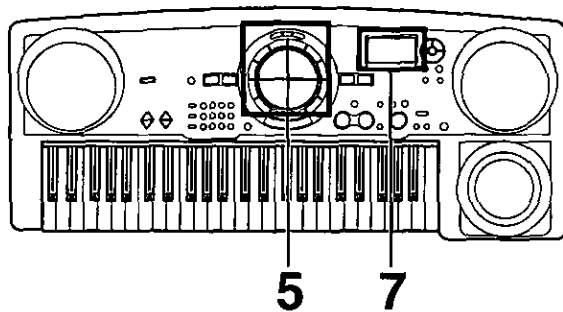

- 5** Mimic the model phrase by tapping the same pad buttons using the same timing (PLAY).

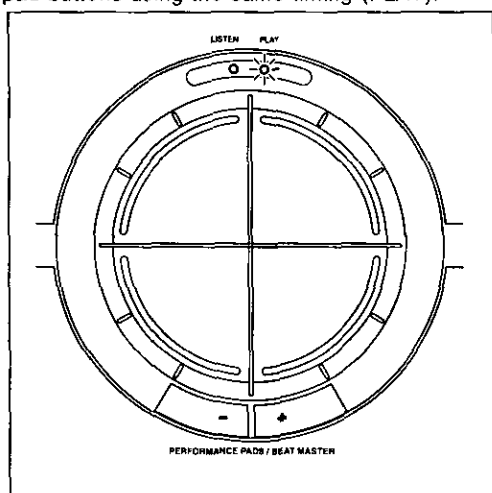

- The **PLAY** indicator is lit to indicate that it's your turn to perform.
- In time with your performance, an answering phrase for the **MB100** performance is played.
- Your performance of each phrase is assessed as "Bravo" (excellent), "Good" (good), or "Poor" (need more practice).

- 7** When the song ends, an evaluation of your performance is shown on the display.
- Your performance is assessed as "Master!" (expert), "Good" (skillful), "Fair" (average), or "Practice" (needs more practice).
  - To try the same lesson again, press the **START/STOP** button. Or you can return to step 2 and try another song.

- 6** Repeat steps 4 and 5.
- For some tunes, the phrases may extend over multiple measures.
  - Some songs may have a "bridge" in which an answering performance is not required, giving you a chance to catch your breath.

#### MEMO

- If you wish to slow down the tempo, you can use the **TEMPO +** and **-** buttons to adjust it.



# Listen to the FM radio

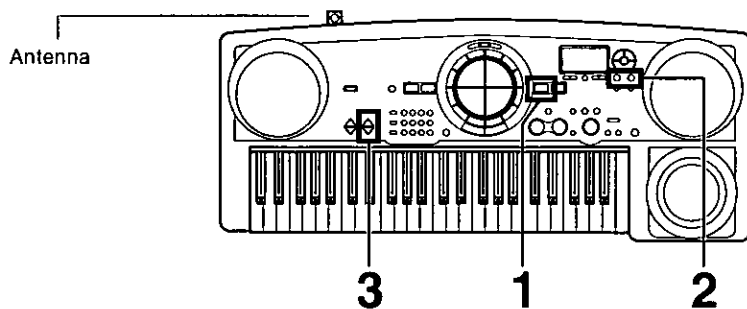

**1** Press the **FM TUNER** button to turn it on.

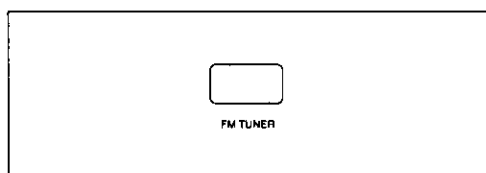

- When this button is on, all other operations such as keyboard performance and CD playback are completely disabled.

**3** Use the **CD/FM TUNER VOLUME** buttons to adjust the volume (0 to 20).

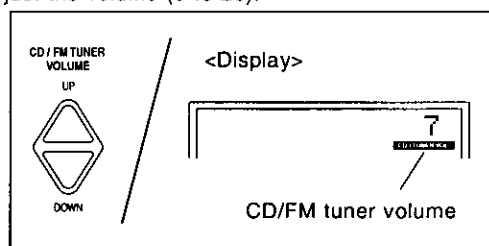

- After a few seconds, the display returns to the previous display.

**2** Use the **FM TUNING +** and **-** buttons to select a station to listen to.

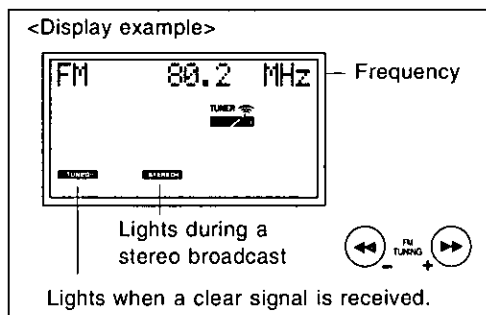

- Press the buttons only briefly to select a station. If the buttons are pressed too long, auto tuning will be activated.

## Auto tune

Press and hold the **FM TUNING +** or **-** button, and release it when the frequency begins to change.

- The frequency automatic stops at the first station that is received.
- If you press the button again, automatic tune stops.
- In some cases when there is signal interference, the signal scan may stop even though a station signal is not being received. In this case you can intermittently tap the button to select the next station.

## MEMO

- When reception is poor, try to improve it by adjusting the length and direction of the radio antenna.

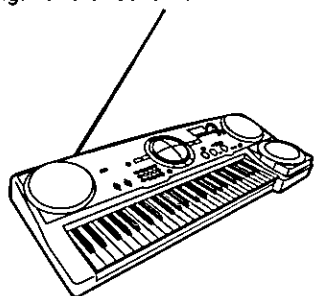

- The radio signal is likely to be strongest if the instrument is situated next to a window.
- You can store your favorite frequency settings in the memory. (Refer to page 26.)

# Selecting sounds

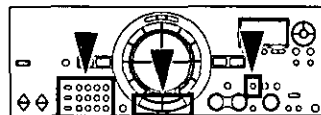

There are 150 different sounds permanently stored in this instrument to enhance your playing enjoyment.

- This operation is not possible when the **FM TUNER** or **BEAT MASTER** mode is selected.

## Sounds

1. Press the **SOUND** button. Use the number buttons to select a sound number (three digits).
- A **SOUND** list is printed on the control panel. For a detailed list of the sounds, refer to the separate Reference Guide provided.

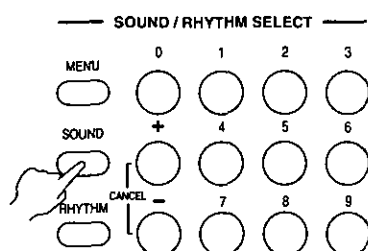

- Enter three digits to specify the sound. For example, for sound number 003, press 0, 0, 3. For sound number 030, press 0, 3, 0.
- The + and - buttons can be used to increase or decrease the number. When a button is pressed and held, the numbers change quickly.
- If you wish to cancel the number you are in the midst of entering, press the + and - buttons at the same time (**CANCEL**). If you pause in the midst of entering a number, the entry may automatically be canceled after a few seconds.
- The selected sound number and sound name are shown on the display.

<Display example>



2. Play the keyboard.
- Non-pitched (percussion) sounds are also available.

## Touch

You can add dynamics to the sound by varying the keyboard touch.

- The initialized setting is ON.

⇒ Use the **TOUCH** button to switch between ON and OFF.

TOUCH



- When set to on, TOUCH is shown on the display.

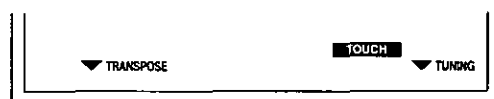

- This function is also effective in the **BEAT MASTER** mode.

## Pad Bank

The different types of phrases are classified into banks in the **PERFORMANCE PADS**. When you switch to a different bank, the phrase in each pad button changes.

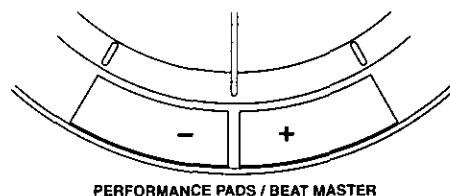

⇒ Change to a different bank with the + and - buttons beneath the pad buttons.

- A **PADS BANK** list is printed on the control panel.
- While you are selecting a different bank, the name of the current bank is shown on the display.

# Tuning



The tuning (pitch) of the entire instrument can be finely adjusted, which is useful during remix play with the CD or when performing along with other instruments, etc.

⇒ Use the TUNING  $\wedge$  and  $\vee$  buttons, below the display to the right, to fine-adjust the tuning.

<Display example>

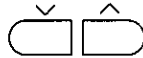
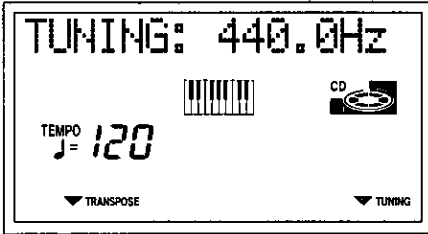

- Adjust the tuning while playing the keyboard to confirm that it is correct.
- Pressing both buttons at the same time will reset the tuning to the standard 440.0 Hz.
- A few moments after you finish adjusting the tuning, the instrument automatically exits the setting mode.
- When VALUE is shown on the display above the buttons, these buttons are used for various settings and cannot be used for TUNING. To access the TUNING function in this case, first exit the setting mode.

# Transpose



The **TRANSPOSE** buttons are used to change the key of the entire instrument in semitone steps across an entire octave.

Suppose you learn to play a song—in the key of C, for example—and decide you want to sing it, only to find that it's either too high or too low for your voice. Your choice is to either learn the song all over again in a different key, or to use the **TRANSPOSE** feature.

⇒ Use the TRANSPOSE  $\wedge$  and  $\vee$  buttons, below the display to the left, to change to a different key.

<Display example>

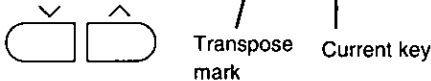
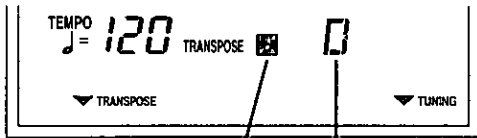

- Each press of the  $\wedge$  button raises the key in semitone steps, and each press of the  $\vee$  button lowers the key in semitone steps, within a one-octave range.
- If the two buttons are pressed at the same time, the key returns to C.
- When the **TRANSPOSE** function is active (that is, when not the key of C), the transpose mark is shown on the display.

- When ITEM is shown on the display above the buttons, these buttons are used for various settings and cannot be used for **TRANSPOSE**. To access the **TRANSPOSE** function in this case, first exit the setting mode.

<Example: transposed to D>

Played keys: C major



Notes that sound: D major



# Selecting rhythms

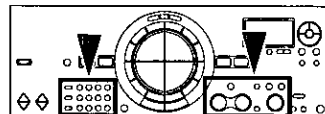

There are 100 rhythms stored in the memory of this instrument.

- This operation is not possible when the **FM TUNER** or **BEAT MASTER** mode is selected.

## Rhythm

1. Press the **RHYTHM** button. Use the number buttons to select a rhythm number (three digits).
- The list of **RHYTHM** is shown near the left end of the panel.

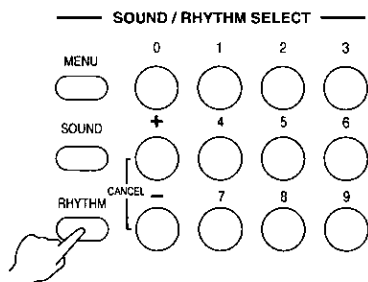

- Enter three digits to specify the rhythm. For example, for rhythm number 003, press 0, 0, 3. For rhythm number 030, press 0, 3, 0.
- The rhythm number and name are shown on the display.



- The + and – buttons can be used to increase or decrease the number. When a button is pressed and held, the numbers change quickly.
- To cancel a number you are entering, press the + and – buttons at the same time (**CANCEL**).

2. Press the **START/STOP** button.

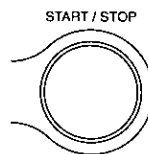

- The selected rhythm pattern begins to play.
- The **BEAT** indicators light to indicate the beat.

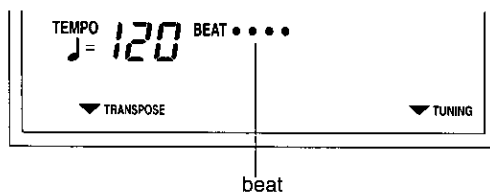

- You can stop the rhythm by pressing the **START/STOP** button again to turn it off.

## Tempo

⇒ Use the **TEMPO +** and **–** buttons to adjust the tempo (♩ = 40 to 300).

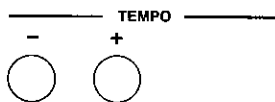

- The tempo is shown on the display.

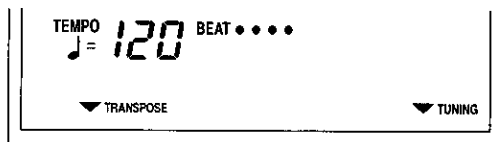

- This function is also effective in the **BEAT MASTER** mode.

## TEMPO PAD

By tapping the **TEMPO PAD** button a few times at the speed you wish to perform, you can easily specify the rhythm tempo.

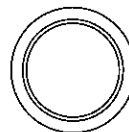

TEMPO PAD

- The length of the intervals in which you tap is detected.
- This function is also effective in the **BEAT MASTER** mode.

## TEMPO HALF/DOUBLE feature

One press of a button can double or halve the rhythm tempo.

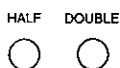

- Press the **HALF** button to slow down the tempo to half speed, or press the **DOUBLE** button to increase it to double speed.
- These buttons are convenient in case the auto detect (page 22) detects a CD tempo that is half or double the actual tempo.
- If by pressing either button the resulting tempo would be less than ♩ = 40 or more than ♩ = 300, the tempo will not change.
- This function is also effective in the **BEAT MASTER** mode.

## SYNCHRO START

With the synchronized start feature, the rhythm pattern starts when you play a key on the keyboard.

1. Select a rhythm.
2. Press the **SYNCHRO START** button.



- When **SYNCHRO START** is on, **SYNCHRO** is shown on the display.

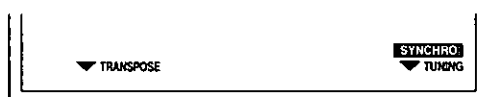

3. Play a key to the left of the keyboard split point (the initialized split point is G3).

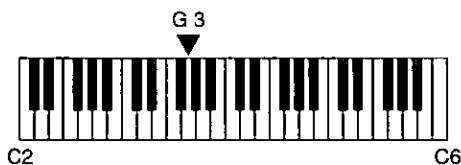

- The rhythm pattern begins to play.
- When the rhythm begins, the **SYNCHRO** indication turns off.

## COUNT INTRO

You can begin the rhythm performance with a one-measure count.

1. During rhythm stop, press the **COUNT INTRO** button to turn it on.



- When **COUNT** is on, **COUNT** is shown on the display.

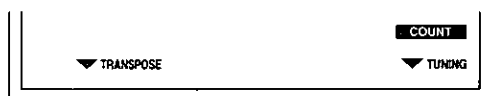

2. Start the rhythm.
- A one-measure count is played, after which the rhythm performance begins.
  - When the rhythm begins, the **COUNT** indication turns off.

## FILL-IN

You can insert a fill-in pattern during the rhythm performance.

1. Start the rhythm.
2. Press the **FILL IN** button.

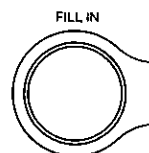

- A fill-in pattern is played for the remainder of the measure.
- When the **FILL IN** button is pressed on the last beat of a measure, the fill-in pattern continues to the end of the following measure.

# Automatic CD tempo detection

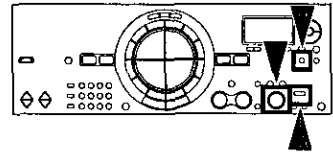

For remix play of the pads and rhythm with a CD, the tempo in a song you are playing from the CD can be automatically detected.

- This operation is enabled in the **CD & KEYBOARD** mode.

## CD TEMPO DETECTION

1. On the CD player in this instrument, play the desired track.
2. Press the **CD TEMPO DETECTION** button.



- The indicator flashes, and auto detect begins.
3. Confirm that the four pad indicators flash in time with the tempo.
- The **CD TEMPO DETECTION** indicator stops flashing and remains lit.
  - If the detected tempo is double or half the actual tempo, use the **HALF** or **DOUBLE** button to correct it.

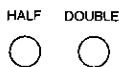

### ■ If auto detect fails to work

In "FAILED, TRY AGAIN" appears on the display;

- 1) Tap the **TEMPO PAD** button in time with the CD song.

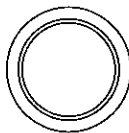

TEMPO PAD

- 2) Press the **CD TEMPO DETECTION** button.
  - 3) When the indicator starts to flash, immediately press it again.
- Begin when the four pad indicators flash in the tempo that you specify.

4. Perform remix play in time with the CD song (page 13).
- Play the pads and rhythm in time with the beginning of the measure. If the timing is incorrect, turn off the pad and rhythm once, and then restart them.
  - If you sense that the two tempos are out of sync, use the **TEMPO +** and **-** buttons to adjust the instrument tempo.
  - If the tempo changes during the song, for example, the CD tempo and instrument tempo may not match. In this case, use the **TEMPO** and **TEMPO PAD** buttons to adjust the tempo, or start the pad or rhythm again at the beginning of a measure.
  - When **CD TEMPO DETECTION** is on, each time the song changes, auto tempo detection is executed. This function can be set to ON or OFF. (Refer to pages 27, 29.)

### NOTE

You may find that the auto detect function does not work well with some types of songs.

The auto detect function may not work well even for some songs having a comparatively stable tempo, for example due to slight tempo differences in a live performance, or depending on the configuration of the instruments. In such cases, follow the same procedure as when the FAILED, TRY AGAIN message appears following auto detect failure, and tap out the tempo on the **TEMPO PAD**.

- For best results, select songs having a very distinct cymbal or hi-hat performance.

# Changing the CD playback mode

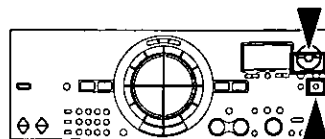

Repeat playback and random order playback are possible with this instrument's CD player.

- This operation is enabled in the **CD & KEYBOARD** mode.
- For basic CD playback, refer to page 10.

## ONE SONG REPEAT

1. Select the track you wish to have played back repeatedly.
2. Use the **PLAY MODE** button to show the one song repeat mark on the display.

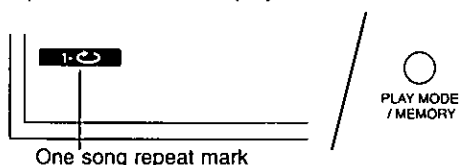

3. If playback is stopped, press the ►/|| button.



- The selected song is played back repeatedly.

## CD REPEAT

1. Use the **PLAY MODE** button to show the all songs repeat mark on the display.

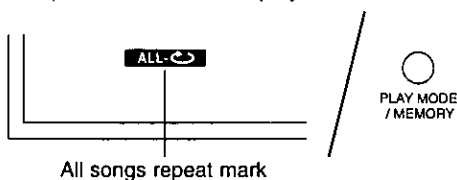

2. If playback is stopped, press the ►/|| button.



- All the songs on the CD are played back repeatedly.

## RANDOM PLAY

1. Use the **PLAY MODE** button to show the random play mark on the display.

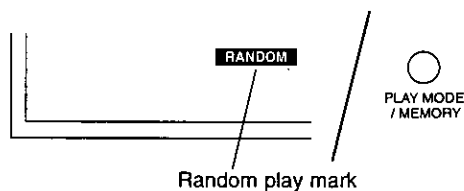

2. Press the ►/|| button.



- The tracks on the CD are played back in random order, after which playback stops.
- In **RANDOM** play, it is not possible to skip to the previous song, nor is it possible to skip to the end of the current song if it is the last song.

### ■ To exit any of the above modes

Press the **PLAY MODE** button several times. Each time the button is pressed, the play indication on the display changes as follows: 1 song repeat → all songs repeat → random play → (off).

# Automatic Accompaniment

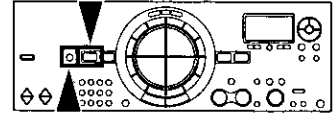

When you play a chord on the keyboard, this function automatically plays an accompaniment pattern that matches your selected rhythm. With a real accompaniment as a background, you can concentrate on playing the melody.

- This operation is enabled in the **AUTO ACCOMPANIMENT** mode.

## Playing chords

You can play a chord with just one finger.

### ■ One-finger mode

A major chord can be played just by pressing the key for its root note.

Example: C chord

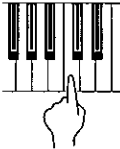

Minor, seventh and minor seventh chords are also easily produced.

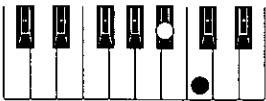
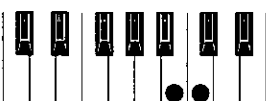
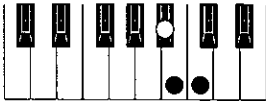
minor chord	seventh chord	minor seventh chord
Play the root note plus a black key to the left of it.	Play the root note plus a white key to the left of it.	Play the root note plus a black key and a white key to the left of it.
Example: Cm	Example: C7	Example: Cm7
		

### ■ Fingered mode

Specify the chord by playing all the notes in the chord.



- Specify the chord by playing at least three notes.
- The following played chords can be detected for each key (C is given as an example):  
 C, Cm, C7, Cm7, Cm7<sup>-5</sup>, C6, Cm6, CM7, Csus4,  
 Caug, Cm<sup>-5</sup>, C7sus4, Caug7, Cdim, C<sup>-5</sup>, C7<sup>-5</sup>,  
 CmM7, CM7<sup>-5</sup>, CM7<sup>+5</sup>, CmM7<sup>-5</sup>, etc.



## How to use the automatic accompaniment

1. Press the **AUTO ACCOMPANIMENT** button to turn it on.



2. Select the desired rhythm and sound(s), and set the tempo.

3. Start the rhythm.

- You can also start the rhythm with a one-measure count. (Refer to page 21.)
- If the **SYNCHRO START** is used, the rhythm begins as soon as a chord is played. (Refer to page 21.)

4. Specify a chord.

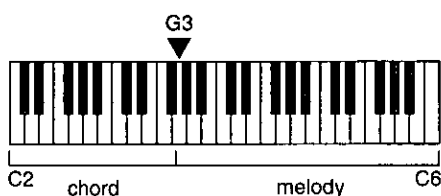

- Specify the chord on the keyboard section to the left of the split point (the initialized split point is G3). The split point can be changed. (Refer to pages 27, 29.)
- An accompaniment pattern in the specified chord is automatically played. Play the melody with your right hand.

- The name of the specified chord is shown in the **CHORD** column on the display.

<Display example>

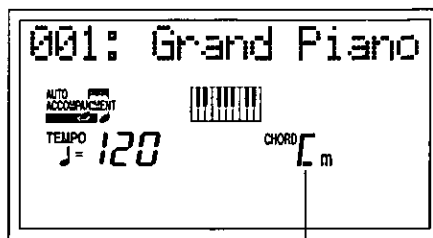

Chord name

- There are some chords that are not displayed even though they are successfully detected.
- An automatic accompaniment is also used in the **FILL IN** patterns.
- Even if you release the chord keys, the accompaniment continues to play until you specify another chord.

5. To stop the automatic accompaniment, press the **START/STOP** button.

- The volume of the automatic accompaniment can be changed. (Refer to pages 27, 28.)
- The automatic accompaniment is comprised of five parts: **DRUMS**, **BASS**, **ACCOMP 1**, **ACCOMP 2** and **ACCOMP 3**. The volume of each of these parts can be adjusted. (Refer to pages 27, 28.)

## One Touch Play

**ONE TOUCH PLAY** automatically sets the sounds, etc. that match your chosen rhythm. Just by pressing a button you can immediately perform using the automatic accompaniment.

- Note that when the automatic settings are executed, the previous settings are canceled.

1. With the rhythm stopped, select a rhythm pattern.

2. Press the **ONE TOUCH PLAY** button.



- Sounds and tempo etc. that match your selected rhythm are automatically set, and the **SYNCHRO START** is turned on.

3. Play the keyboard.

- When you specify a chord, the automatic rhythm begins to play immediately.

- When the **CD & KEYBOARD** button is on, the **ONE TOUCH PLAY** button becomes button to select recommended settings for a CD remix performance. (Refer to page 12.)

# Storing FM station settings

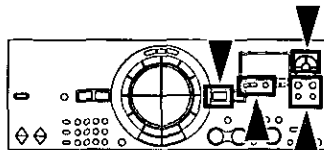

Store the settings for your favorite FM stations so they are easy to recall.

- This operation is enabled in the **FM TUNER** mode.
- For basic radio operation, refer to page 17.

## Storing a station setting.

1. Press the **FM TUNER** button to turn it on.

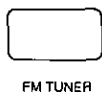

2. Use the **FM TUNING +** and **-** buttons to select an FM radio station.

<Display example>

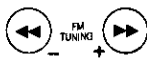
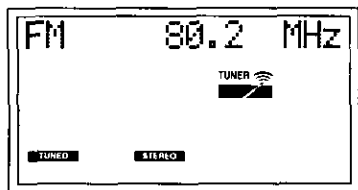

- You can also use the auto tune feature to automatically find a station. (Refer to page 17.)

3. Press the **MEMORY (PLAY MODE)** button.



4. Use the **ITEM** buttons, below the display to the left, to select a channel for the station (1 to 12).

<Display example>

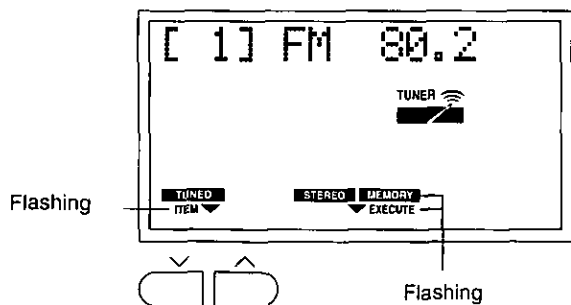

5. Press the **EXECUTE** button.

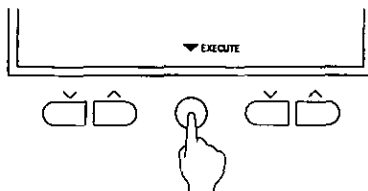

- "COMPLETED!" is shown on the display.
- The storing procedure is completed, and the instrument exits the store memory mode. Note that if the **EXECUTE** button is not pressed, the preset channel is not stored, and after a few seconds the instrument exits the store memory mode.

6. Repeat steps 2 to 5 to store station settings in each preset channel, as desired.

## Recalling stored station settings

1. Press the **FM TUNER** button to turn it on.

2. Use the **PRESET TUNING** buttons to select a preset channel.

<Display example>

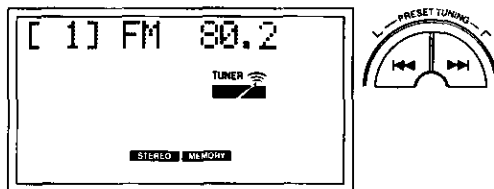

## FM MODE

Use this mode to reduce spurious noise in the FM stereo broadcasts.

⇒ Press the **FM MODE** button.

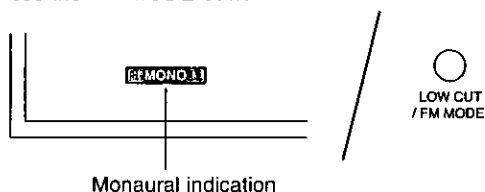

- The sound changes to monaural output, but spurious noise is reduced, making the radio station easier to listen to.
- Exit the **FM MODE** by pressing the button again. (This is the normal setting for this button.)
- Station settings cannot be stored as presets when the monaural status is active.

## Changing the tuning interval

The tuning frequency interval can be changed from 0.1 MHz to 0.2 MHz, and vice versa.

⇒ Press and hold the **FM TUNER** button (about 10 seconds).

- After about 5 seconds, 87.9/87.50 will flash on the display. If you continue to press and hold the button, after about 10 seconds the indication will change to 87.50/87.9 and the operation to change the tuning frequency interval is complete. If you release the button before this indication appears, the frequency step remains unchanged.
- You can repeat this procedure to return to the original setting.
- Note that this procedure will erase the preset channel memories.

## Other Settings

Various menu functions enhance the capabilities of your instrument.

- This operation is not available in the **FM TUNER** or **BEAT MASTER** mode.

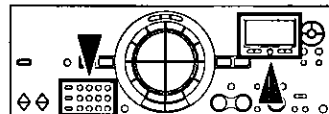

## Outline of the procedure

1. Press the **MENU** button to turn it on.

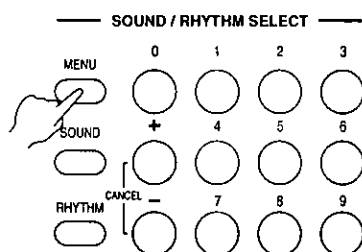

2. Use the number buttons to enter the menu number for the function you wish to set (2 digits).

- The + and - buttons can also be used to specify the menu number.

### ■ Menu list

- 01: RHY&PAD VOL  
Overall volume setting for the automatic accompaniment and pads.
- 02: PART VOLUME  
Adjust the volume of each part.
- 03: PART SOUND  
Adjust the sound for each part.
- 04: PART PANPOT  
Adjust the stereo balance of each part.
- 05: SPLIT POINT  
Change the keyboard split point.
- 06: TEMPO DETECT  
Specify whether or not CD tempo detect functions each time the song changes.
- 07: FOOT SWITCH  
Assign a function to the Foot Switch (separately sold option).
- 08: LCD CONTRAST  
Adjust the readability of the display.
- 09: LIGHT SHOW  
Specify whether or not the light show (indicators flicker when this instrument has been silent for a while) is enabled.
- 10: ALL INITIAL  
Return all the instrument functions and settings to their factory-preset status.

(Continued on the next page)

3. Press the EXECUTE button.

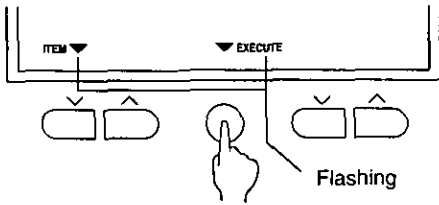

- The display changes to show the setting display for the selected menu.

4. Use the ITEM, VALUE, and/or EXECUTE buttons below the display, as well as the number buttons, to change the settings (explained in detail below).

5. When you have finished changing the settings, press the MENU button again to turn it off.

## ■ About the parts

This instrument is formed of the following sound generator parts.

- Performance parts (PART 1 to 16)
- Automatic accompaniment parts (ACCOMP 1 to 3, BASS, DRUM)
- PERFORMANCE PADS part (PAD)
  - Use PART 1 to 16 when external MIDI equipment is used to make this instrument function as a 16-part GM sound generator.
  - PART 1 is used for this instrument's sounds.
  - PART 16 is the drums part.

## RHYTHM & PAD VOLUME

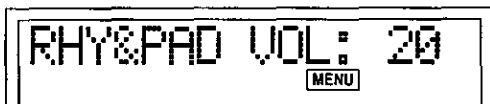

- ⇒ Use the VALUE buttons or the number buttons (2 digits) to adjust the volume (0 to 20).
- This setting changes the total volume for the automatic accompaniment and the pads.

## PART VOLUME



1. Use the ITEM buttons to select a part.
  - ACMP is the abbreviation for ACCOMP.
  - PAD is the abbreviation for PERFORMANCE PADS.
2. Use the VALUE buttons or the number buttons (3 digits) to adjust the volume for the selected part (0 to 127).
  - Repeat the above steps for each part, as desired.
  - If the VALUE ^ and V buttons are pressed simultaneously, the volume for the selected part is muted. When muting is active, "--" is shown on the display. Muting can be canceled by pressing either button.

## PART SOUND

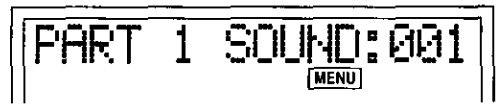

1. Use the ITEM buttons to select a part (PART 1–16).
2. Use the VALUE buttons or the number buttons to select a sound for the part (001 to 150).
  - For PART 16, only the DRUM KITS sound can be selected.

## PART PANPOT



1. Use the ITEM buttons to select a part (PART 1–15).
  - PART 16 cannot be selected.
2. Use the VALUE buttons or the number buttons (3 digits) to adjust the stereo balance.
  - The sound is completely to the left at 0, exactly in the center at 64, and completely to the right at 127.
  - If the VALUE ^ and V buttons are pressed simultaneously, the stereo balance is set to 64 (center).

## SPLIT POINT



⇒ Press a key on the keyboard to specify the desired split point.

- The name of the specified key is indicated on the display.
- The factory-preset (initialized) split point is at G3.
- The key at the split point is the lowest note of the right keyboard section.

## TEMPO DETECT



⇒ Use the VALUE buttons to switch the CD TEMPO DETECT function ON or OFF.

ON: Tempo detect works each time the CD song changes (initialized setting).

OFF: Tempo detect does not work when the CD song changes.

## FOOT SWITCH

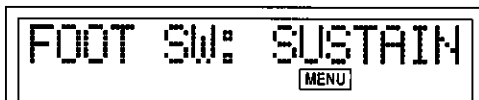

⇒ Use the VALUE buttons to assign a function to the Foot Switch (separately sold option).

- Select from SUSTAIN, START/STOP [ST/STOP], and GLIDE.
- If the polarity of the switch is reversed, select a function name that is preceded by a – mark.
- When the Foot Switch is depressed, the specified function will turn on.
- The glide effect “bends” the pitch down by about one semitone. (This effect may not work for some sounds.)
- For Foot Switch connection, refer to page 30.

## LCD CONTRAST



⇒ Use the VALUE buttons to adjust the display so that it is easy to read (1 to 10).

## LIGHT SHOW

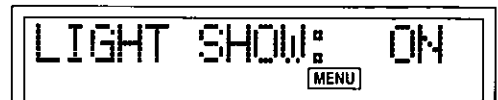

⇒ Use the VALUE buttons to set the LIGHT SHOW to ON or OFF.

ON: When the power is on, if this instrument has been silent for a while, the pad buttons and the indicators start to flash in a kind of “light show”.

OFF: The light show does not start.

## ALL INITIAL



⇒ Press the EXECUTE button.

- “COMPLETE” is shown on the display, and all the settings of this instrument are reset to their factory-preset status.
- The settings can also be initialized by turning off the power once, then turning on the power again while depressing both **TEMPO +** and **–** buttons.
- Playback will stop if this operation is performed while a CD is being played.
- The following settings will be initialized by this procedure.
  - KEYBOARD VOLUME
  - CD/FM TUNER VOLUME
  - FM PRESET TUNING memories
  - LIGHT SHOW on/off setting

### ■ Memory function

The settings of this instrument are retained as long as the AC adaptor remains plugged into an electrical outlet.

- The following settings are retained even when the AC adaptor is disconnected from the electrical outlet.
  - FM PRESET TUNING memories
  - LIGHT SHOW on/off setting

# Connection terminals and optional accessories

## Connection terminals

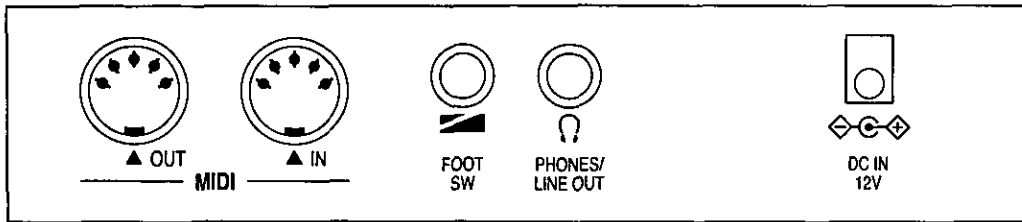

(Rear panel)

### MIDI OUT

Used for transmitting MIDI data. Connect the other end of the MIDI cable to the MIDI IN terminal of another instrument. This terminal is used, for example, to generate sound from a connected instrument by playing this instrument.

### MIDI IN

Used for receiving MIDI data. Connect the other end of the MIDI cable to the MIDI OUT terminal of another instrument. This terminal is used, for example, to generate sound from this instrument by playing a connected instrument.

- A MIDI cable is used for MIDI connections.

### FOOT SW

An optional **SZ-P1** Foot Switch (sold separately) can be connected to this terminal to control various functions.

### PHONES/LINE OUT (output level 1.5 Vrms, 16 Ω)

Headphones, a keyboard amplifier, or stereo equipment can be connected to this terminal. When another apparatus is connected to this terminal, the speaker system is automatically switched off, and sound is heard only through the connected device.

---

## Separately sold option

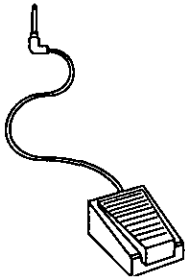

**SZ-P1** Foot Switch

- For the various functions that can be controlled with a Foot Switch, refer to pages 27, 29.

# Symptoms which appear to be signs of trouble

The following changes in performance may occur but do not indicate trouble.

	Phenomenon	Cause or Remedy
Keyboard	The buttons, keys, etc. do not function.	<ul style="list-style-type: none"> <li>• Turn off the power once, then turn it on again. If this procedure is not successful, turn off the power once. Then, while pressing both <b>TEMPO +</b> and <b>-</b> buttons at the same time, turn the power on again.</li> </ul>
	No sound is produced when the keys are pressed.	<ul style="list-style-type: none"> <li>• The <b>KEYBOARD VOLUME</b> is set to the minimum level. Set it to a suitable level.</li> <li>• The volume for <b>PART 1</b> is set to the minimum level or is muted. Set it to a suitable level. (Refer to pages 27, 28.)</li> <li>• The <b>FM TUNER</b> mode is selected. Select a different mode.</li> </ul>
	Only percussion instrument sounds are produced when the keyboard is played.	<ul style="list-style-type: none"> <li>• The <b>DRUM KITS</b> sound (139–150) is selected. Select another sound.</li> </ul>
	The rhythm does not play.	<ul style="list-style-type: none"> <li>• The <b>DRUM</b> part volume is set to the minimum level or is muted. Set it to a suitable level. (Refer to pages 27, 28.)</li> </ul>
	The CD tempo cannot be detected.	<ul style="list-style-type: none"> <li>• If "FAILED, TRY AGAIN" is shown on the display, the auto detect was not successful. Use the <b>TAP TEMPO</b> or <b>TEMPO</b> buttons to set the correct tempo. (Refer to page 22.)</li> </ul>
CD	No sound is produced.	<ul style="list-style-type: none"> <li>• The <b>CD/FM TUNER VOLUME</b> is set to the minimum level. Set it to a suitable level.</li> </ul>
	The CD does not play back correctly.	<ul style="list-style-type: none"> <li>• Press the <b>CD OPEN/CLOSE</b> button to open the CD tray, and then press it once again to reload the CD.</li> </ul>
	Performance is not possible. Even with a CD inserted, the track number, etc is not shown on the display.	<ul style="list-style-type: none"> <li>• The CD has been inserted upside down.</li> <li>• The inserted CD is not a standard audio CD.</li> <li>• A CD which is extremely warped or scratched cannot be used.</li> <li>• If the CD or the instrument was suddenly moved from a very cold to a very warm place, moisture may have formed on the CD player lens. Wait for one hour and try again.</li> </ul>
	A particular portion of the CD cannot be played.	<ul style="list-style-type: none"> <li>• The CD may require cleaning. Use a soft cloth to wipe it.</li> </ul>
FM tuner	No sound is heard.	<ul style="list-style-type: none"> <li>• The <b>CD/FM TUNER VOLUME</b> is set to the minimum level. Set it to a suitable level.</li> </ul>
	Spurious noise makes station selection difficult.	<ul style="list-style-type: none"> <li>• Try moving the antenna direction to improve reception.</li> </ul>
	Spurious noise makes listening difficult.	<ul style="list-style-type: none"> <li>• The noise from a TV or video deck may be interfering with FM reception. Try turning off any such devices.</li> </ul>

# Error messages

Indication	Contents
PLEASE WAIT!	Appears when it takes some time to complete an operation.
COMPLETED!	Appears when an operation has been completed.
NO DISC	You have attempted to play a CD in the <b>CD &amp; KEYBOARD</b> mode, but no CD is inserted.
SORRY!	During CD play, the instrument was jarred and sound was interrupted.
FAILED, TRY AGAIN	Appears when the CD tempo was unable to be detected within a given time, and the instrument automatically exits the CD tempo detect mode.
ERROR!	Appears briefly when some other error is detected.

## About the CD



Use a CD which has this mark.

- Please do not use a CD with a heart or other special mark, as doing so may result in damage.



- Do not insert more than one CD at a time.
- Be sure to remove the CD from the tray before moving or tilting the instrument.

■ **To avoid injuring your CD, as well as damaging your instrument, please heed the following points.**

- Do not use a pencil or ball point pen to write on the CD.
- Do not wipe with record cleaner, thinner, benzene or alcohol. If soiled, use a clean damp cloth to wipe it clean, and polish it with a soft, dry cloth.
- Do not affix paper or stickers (decals). (Do not use a CD from which cellophane tape or a glue-backed label has been peeled off, as the residual glue may result in damage.)

## About the ANTI-SKIP SYSTEM

The ANTI-SKIP SYSTEM minimizes any interruption to the sound due to vibration by using pre-sampled (up to 10 seconds) performance data.

- The ANTI-SKIP SYSTEM in this instrument is always active whenever the power is on. (The function cannot be disabled.)
- If the instrument is subjected to consecutive shocks, "SORRY" may appear on the display and the sound interrupted.

**Note:** The ANTI-SKIP SYSTEM in this instrument uses digital compression technology.



# Index

<b>A</b>	
AUTO ACCOMPANIMENT .....	24
<b>B</b>	
BEAT MASTER .....	14
<b>C</b>	
CANCEL .....	18
CD OPEN/CLOSE .....	10
CD/FM TUNER VOLUME .....	10, 17
CD&KEYBOARD .....	10, 12
CD TEMPO DETECTION .....	12, 22
COUNT INTRO .....	21
<b>D</b>	
DOUBLE .....	21
<b>F</b>	
FILL IN .....	21
FOOT SW .....	30
FM MODE .....	27
FM TUNER .....	17
FM TUNING .....	17, 26
<b>H</b>	
HALF .....	21
<b>K</b>	
KEYBOARD VOLUME .....	6
<b>L</b>	
LINE OUT .....	30
LOW CUT .....	13
<b>M</b>	
MENU .....	27
MEMORY .....	26
MIDI .....	30
<b>O</b>	
ONE TOUCH PLAY .....	12, 25

<b>P</b>	
PAD STOP .....	13
PERFORMANCE PADS .....	13
PHONES .....	30
PLAY MODE .....	23
PRESET TUNING .....	26
<b>R</b>	
RHYTHM .....	20
<b>S</b>	
SOUND .....	18
SOUND/RHYTHM SELECT .....	18, 20
START/STOP .....	20
SYNCHRO START .....	21
<b>T</b>	
TEMPO .....	20
TEMPO PAD .....	20
TOUCH .....	18

# Specifications

	<b>SX-MB100</b>
KEYBOARD	49 KEYS (WITH INITIAL TOUCH)
MAX. POLYPHONY	32 NOTES
SOUNDS	150 SOUNDS
TRANSPOSE	±1 OCTAVES
RHYTHMS	100 RHYTHMS
RHYTHM CONTROLS	SYNCHRO START, START/STOP, COUNT INTRO, FILL IN
TEMPO CONTROLS	+, -, HALF, DOUBLE, TEMPO PAD, CD TEMPO DETECTION
OTHER FUNCTIONS	BEAT MASTER, AUTO ACCOMPANIMENT, ONE TOUCH PLAY, KEYBOARD VOLUME, CD/FM TUNER VOLUME, MENU
PADS	4 PADS, 10 BANKS
DISPLAY	CUSTOM LCD (WITH BACKLIGHT)
TERMINALS	MIDI IN, MIDI OUT, FOOT SW, PHONES/LINE OUT
OUTPUT	5 W (2.5W × 2)
SPEAKERS	12 cm × 2
POWER REQUIREMENT	DC IN 12 V (WITH EXCLUSIVE AC ADAPTOR)
POWER CONSUMPTION	16 W (WHEN THE POWER IS OFF: ABOUT 4 W)
DIMENSIONS (W × H × D)	96.0 cm × 16.7 cm × 43.1 cm (37-25/32" × 6-9/16" × 16-3/32")
NET WEIGHT	6.1 kg (13.4 lbs)
ACCESSORIES	AC ADAPTOR, MUSIC STAND, REMIX DEMO CD

• Design and specifications are subject to change without notice.

<b>FM TUNER</b>	<b>FREQUENCY RANGE</b>	FM: 87.5–108.00 MHz (50 kHz STEPS)
<b>CD PLAYER</b>	<b>SAMPLING FREQUENCY</b>	44.1 kHz
	<b>DECODING</b>	16 bit LINEAR
	<b>BEAM SOURCE</b>	SEMICONDUCTOR LASER (WAVELENGTH 780 nm)
	<b>NO. OF CHANNELS</b>	2 CHANNEL, STEREO
	<b>WOW AND FLUTTER</b>	BELOW MEASURABLE LIMIT
	<b>D/A CONVERTER</b>	16 bit DAC

## EXCLUSIVE AC ADAPTOR

<b>PART NO.</b>	<b>REGION</b>	<b>VOLTAGE</b>
QFAG028A	NORTH AMERICA, MEXICO	120 V
QFAG029A	UNITED KINGDOM	230 – 240 V
QFAG030A	EUROPE, SOUTH AFRICA	230 V
QFAG031A	AUSTRALIA, NEW ZEALAND	230 – 240 V
QFAG032A	TAIWAN, MALAYSIA, SINGAPORE, ETC.	120/220/230/240 V
QFAG038B	SAUDI ARABIA, KUWAIT, HONG KONG	120/220/230/240 V
QFAG039B	ARGENTINA	120/220/230/240 V



**PANASONIC CONSUMER ELECTRONICS COMPANY**  
**DIVISION OF MATSUSHITA ELECTRIC CORPORATION OF AMERICA**  
One Panasonic Way, Secaucus, New Jersey 07094

[Consumerproducts@Panasonic.com](mailto:Consumerproducts@Panasonic.com)

**ENGLISH**

**M Se0301S0 QQTG0626A**